



**COPY-RIGHT RESERVED**  
**版权所有 违者必究**

# POLE ANCHORS →



**GREENPOST**®



**HEBEI MINMETALS CO.,LTD.**



## INTRODUCTION TO ENTERPRISE

Hebei Minmetals Co., Ltd. is a leading manufacturer, importer and exporter, located in Northern China's Hebei Province. Drawing on abundant local resources of steel, the company produces a wide range of metal products, including rolled fencing and fence posts, fasteners: nails and screws, building materials, lawn & garden items: trellis / borders / arbors / decorative fence, residential steel fence and gates, pet containment: kennels and pet cages, as well as auto parts, various agricultured products and hardware items.

With headquarter in Shijiazhuang, Hebei Province, the company manufacturers at numerous factories throughout China, Thailand and Taiwan, both in fully owned production facilities, Joint Venture investments, as well as factories with partial equity ownership. The products that are manufactured flow to North American, European, Asian, South American, Australian and African markets to make the company a true global entity. Additionally, the company has overseas offices and company owned distribution and marketing of its products.

Hebei Minmetals is committed to supply superior products and excellent customer service, as it serves its customers and expands into new markets.

Thanks for your support and assistance!

We remain,



Yours faithfully  
Hebei Minmetals Co.,

ABOUT  
MINMETALS





reenpost is the leading Chinese brand for post and fence erection products. In the past few years, a lot of new designs and types have been made to meet customer's demand. This wide range makes post and fence erection more easier in any circumstances. Now more than 2 million pcs of Geenpost put in use on worldwide markets each year.

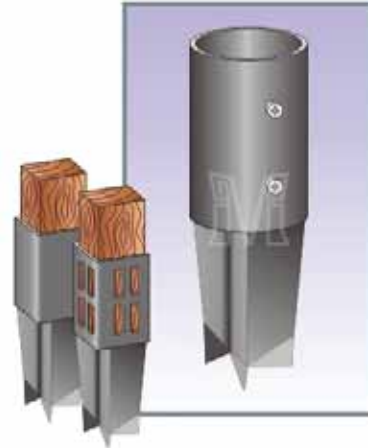

### System available

- (1) Standard: with two holes on the sockets, when erect, put the timber post inside, drill holes through the post and fix the post to the socket with bolts and nuts. Offers can be made for both without and with bolts and nuts upon request.
- (2) Wedge Grip: this system requires no nails or screws, when the timber post hammered inside the socket, it cuts into timber and holds it in a vice-like grip. The other advantage is it support timber widths varying by as much as 4mm.
- (3) Twin-bolt-A: this twin bolt heavy duty system makes the post installation and replacements more easier, it is strong enough to withstand gale force winds.
- (4) Twin-bolt-B: This new jointly designed and patented by Hebei Minmetals Co., Ltd. Has many advantages. Besides same as Twin-bolt-A, this system also has the following:
  - (A) The special Tee-bolts cannot revolve so the nuts can be tightened very easily with a single spanner.
  - (B) All four faces of the socket can be abutted by a fence panel.
  - (C) The right-angle locating tooth inside holds the base of the fence post laterally and eliminates any possibility of post waggle under windload.



Standard



Wedge Grip



Twin-bolt-A



Twin-bolt-B



### Finish available

- (1)hot dip galvanized      (2)electrical galvanized
- (3)epoxy powder coated in Brown, green, other colors may available upon request.
- (4)Painted in Brown, green, other colors may available upon request.



### Packing available

- (1)in cartons.      (2)On pallets.

### Pole anchors pointed(Soil spike)

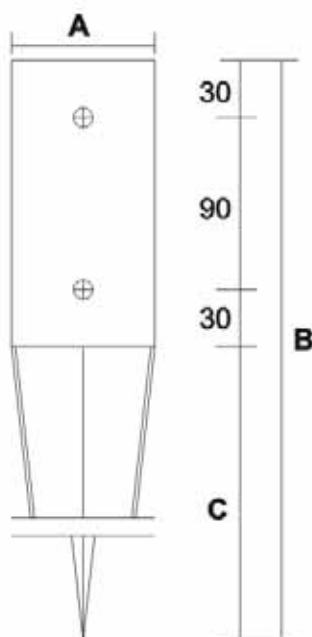
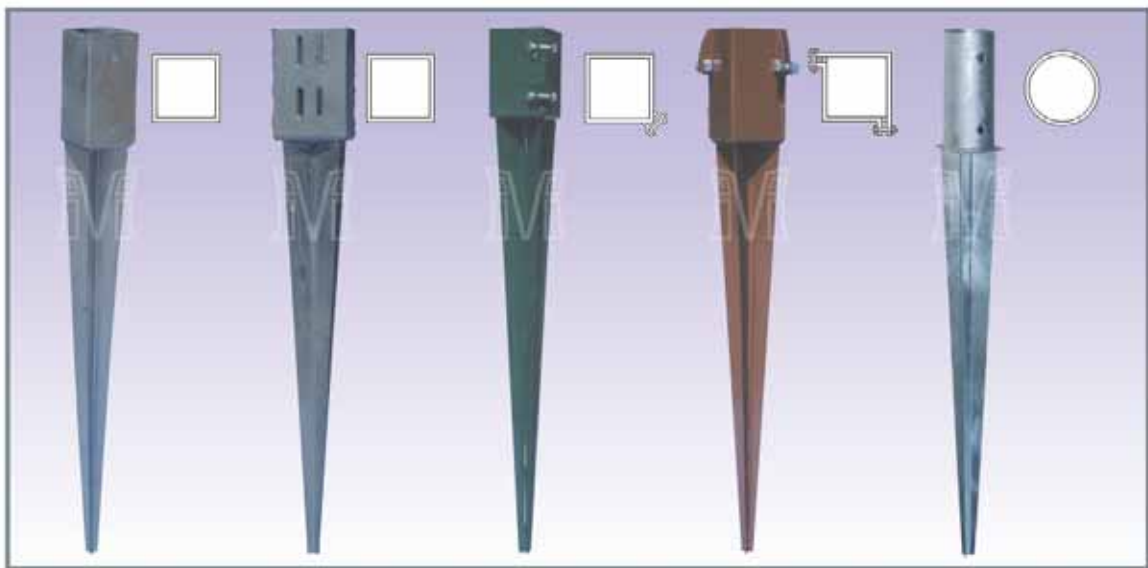

- PAP01 (A)61×61×(B)750×(C)600 mm
- PAP02 (A)71×71×(B)750×(C)600 mm
- PAP03 (A)71×71×(B)900×(C)750 mm
- PAP04 (A)91×91×(B)750×(C)600 mm
- PAP05 (A)91×91×(B)900×(C)750 mm
- PAP06 (A)101×101×(B)900×(C)750 mm
- PAP07 (A)121×121×(B)900×(C)750 mm
- PAP08 (A)51×51×(B)600×(C)450 mm
- PAP09 (A)51×51×(B)650×(C)500 mm
- PAP10 (A)51×102×(B)750×(C)600 mm
- PAP11 (A)77×77×(B)750×(C)600 mm
- PAP12 (A)102×102×(B)750×(C)600 mm
- PAP13 (A)75×75×(B)750×(C)600 mm
- PAP14 (A)Φ 81×(B)600 mm
- PAP15 (A)Φ 101×(B)600 mm
- PAP16 (A)Φ 121×(B)900 mm



### Screw-in anchor:

Instead of hammer into ground, this new screw-in anchor goes into ground easily with the spanner-bar.

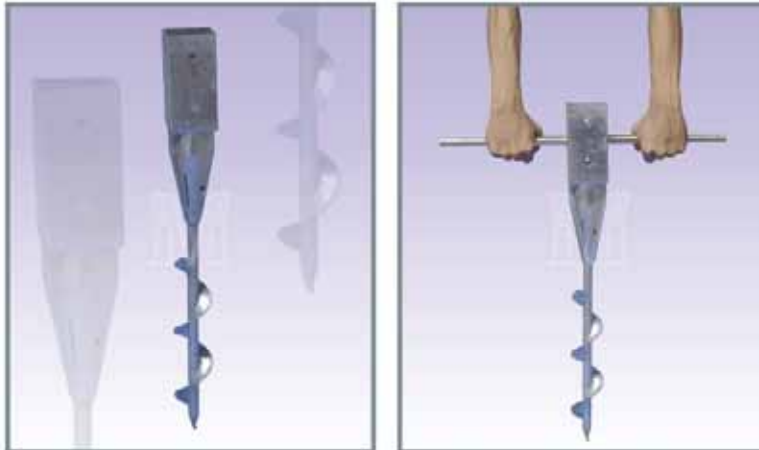

91×91 × 800 mm  
71×71 × 800 mm

### Screw-in Earth sleeves

This new screw-in earth sleeve with five different plastic adapter sleeves which suitable for a tube from 25-65 mm, this system makes it has a wide purpose of uses. Instead of hammer into ground, it goes into ground easily with the spanner- bar.

SIZE:

Dia. Available 25mm, 38mm, 43mm, 50mm, 55mm, 65mm

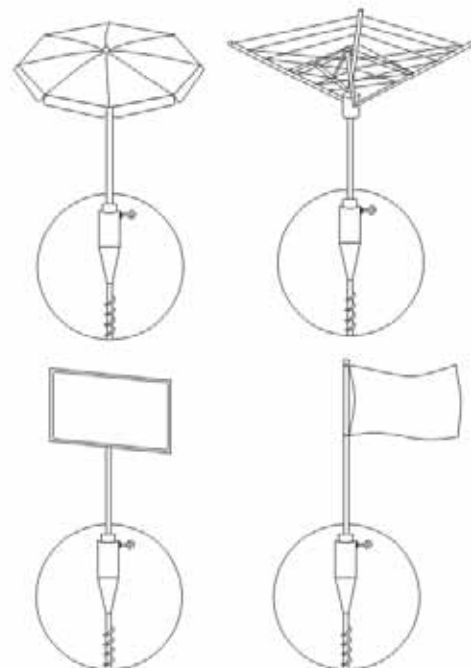



### Pole ground plate (Bolt-down)

This ground plate is idea where circumstances do not allow the anchor to be driven into the ground, such as concrete base, or on decking, this Bolt-down gives the good solution. It can be the support for patio fencing, rose arches etc.



GREENPOST®

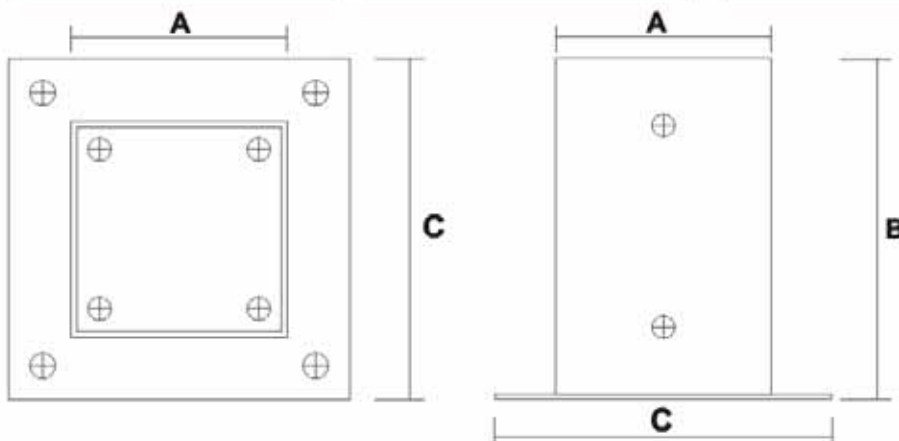
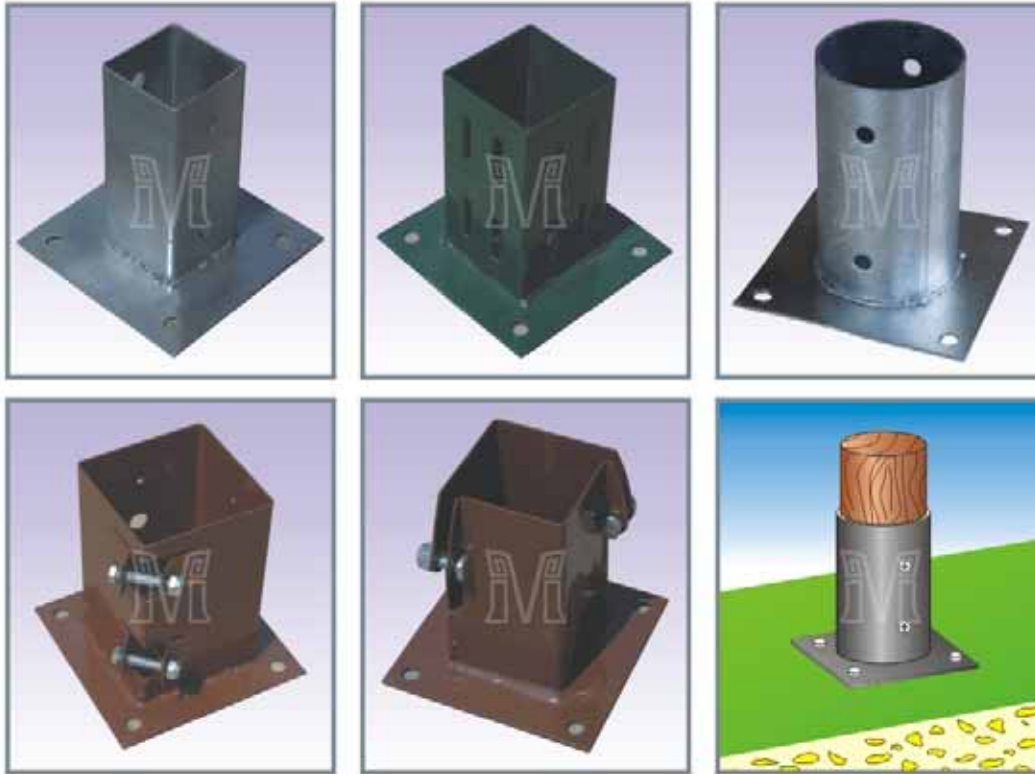

- PGP01 (A)71×71×(B)150×(C)150 mm
- PGP02 (A)81×81×(B)150×(C)150 mm
- PGP03 (A)91×91×(B)150×(C)150 mm
- PGP04 (A)101×101×(B)150×(C)150/180 mm
- PGP05 (A)121×121×(B)180×(C)180 mm
- PGP06 (A)145×145×(B)150×(C)200 mm

- PGP07 (A)Φ 81×(B)150×(C)150 mm
- PGP08 (A)Φ 101×(B)150×(C)150 mm
- PGP09 (A)Φ 121×(B)150×(C)180 mm



## Pole anchor (Concrete-in)

This anchor has been designed for used in hard standing areas. Laid it in the wet concrete for enough strength. The anchor is ideal for car ports, pergolas and general fencing application.

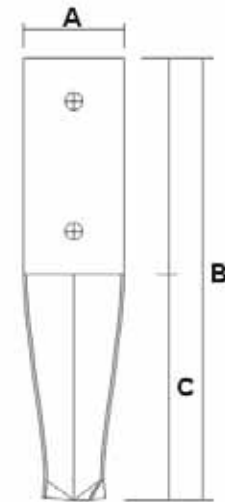

- PA01 (A)71×71×(B)350×(C)200 mm
- PA02 (A)91×91×(B)350×(C)200 mm
- PA03 (A)101×101×(B)350×(C)200 mm
- PA04 (A)75×75×(B)350×(C)200 mm

## Repair Spur

This Spur provides the solution to fence posts which have broken off in an existing sound concrete base. If the posts broken off at ground level, the repair spur can be hammered directly into the base of the rotten / broken post, and install a new timber post.



- RS01 (A)71×71×(B)450×(C)300 mm
- RS02 (A)75×75×(B)450×(C)300 mm
- RS03 (A)91×91×(B)450×(C)300 mm
- RS04 (A)100×100×(B)500×(C)350 mm



## Post extender



This post extender enable to increase the height of any existing fence, it is recommended to raise the height of the existing fence up to max. 1 metre.



PE01	50×50×150 mm
PE02	71×71×150 mm
PE03	75×75×150 mm
PE04	91×91×150 mm
PE05	100×100×150 mm

## Fence-making metalworks

With investment of new machines and moulds, most of the popular fence-making metal products are available in the Greenpost range, this metals products makes the fence erection quite easier. The main items including:

- long-roll stakes;
- Arris rail Bracket;
- Arris rail holder both left / right hand
- Mortise Holder
- Panel clip
- Trellis clip
- Wooden gravel bracket
- Concrete gravel bracket
- Others maybe available upon request and samples or drawings are welcome.

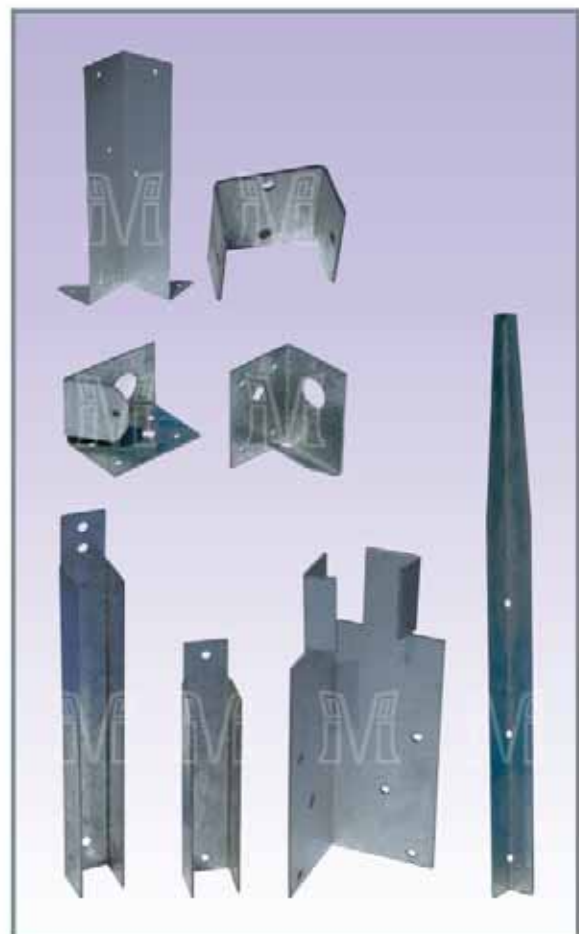





## Driving tools

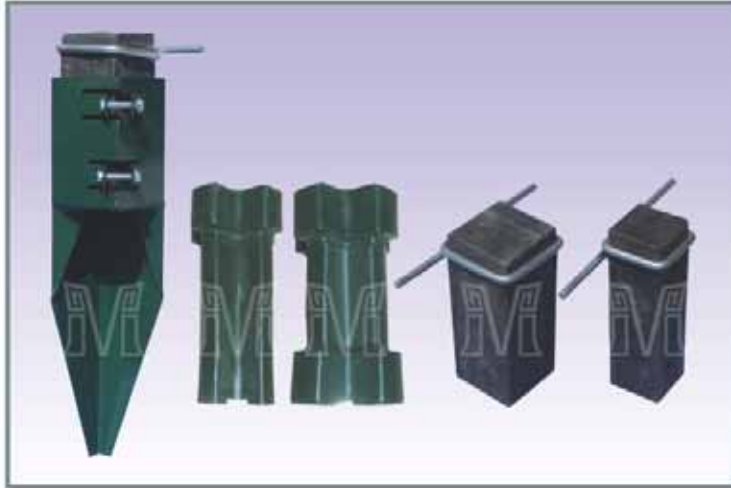

Plastic

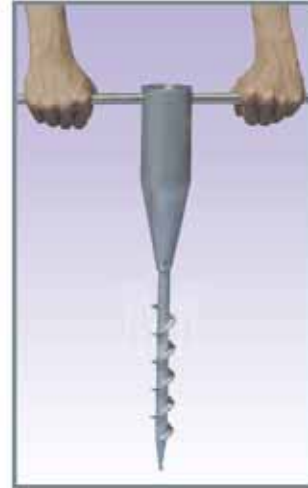

Spanner Bar

## Decoration Caps

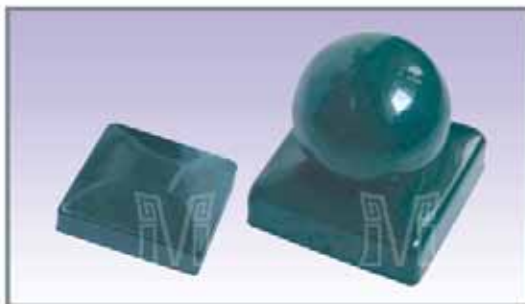
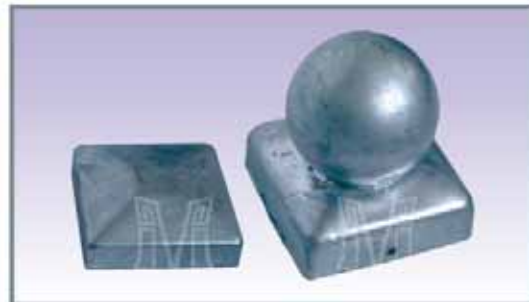
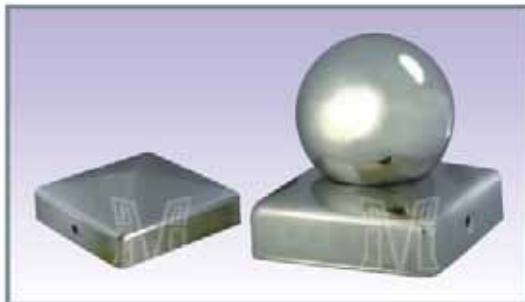

### Type of finish available:

Hot-dip galvanised  
Copper  
Stainless  
Powder coated

DC01 71×71 mm  
DC02 91×91 mm  
DC03 101×101 mm  
DC04 121×121 mm  
DC05 141×141 mm





## Mini-L Support

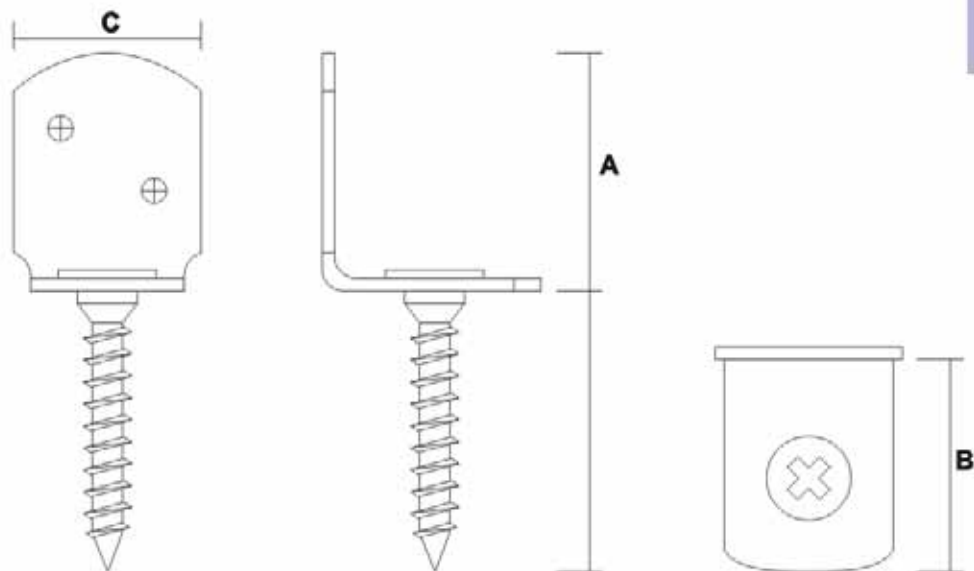

### Type of finish available:

Hot-dip galvanised  
Electrical galvanised  
Stainless steel

### Packing: in cartons.

**MLS01** (A)36×(B)34×(C)30 mm  
**MLS02** (A)35×(B)40×(C)30 mm  
**MLS03** (A)38×(B)34×(C)30 mm  
**MLS04** (A)70×(B)30×(C)30 mm



### H-Form Support

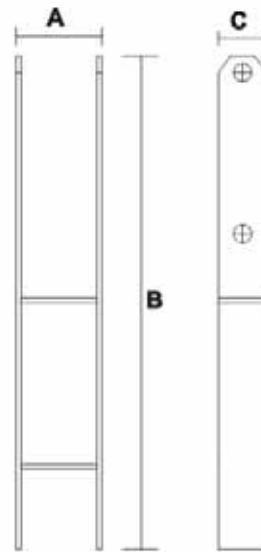
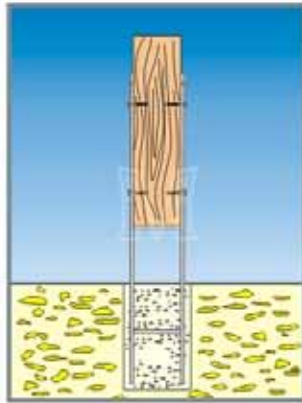

#### Type of finish available:

Hot-dip galvanised  
Electrical galvanised

Packing: on pallets

HF01	(A)71×(B)600×(C)60/50 mm
HF02	(A)81×(B)600×(C)60/50 mm
HF03	(A)91×(B)600×(C)60/50 mm
HF04	(A)101×(B)600×(C)60/50 mm
HF05	(A)121×(B)600/800×(C)60/50 mm
HF06	(A)141×(B)600/800×(C)60/50 mm

### TT-Form Support

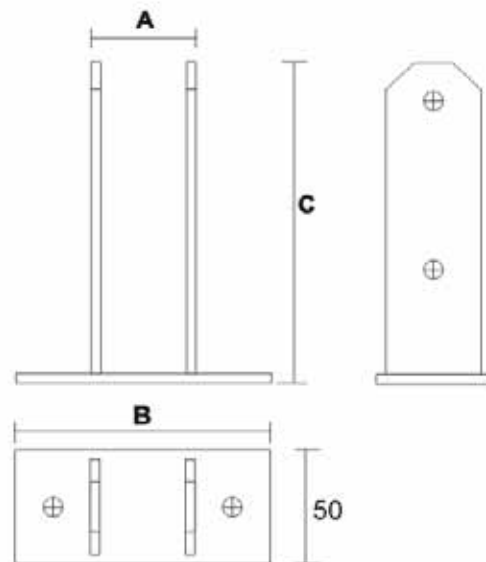
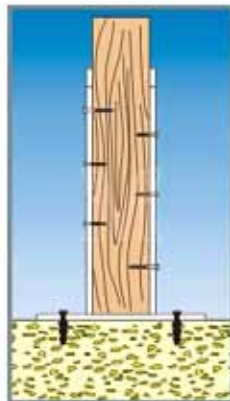

#### Type of finish available:

Hot-dip galvanised  
Electrical galvanised

Packing: on pallets

TTF01	(A)71×(B)200×(C)200 mm
TTF02	(A)81×(B)200×(C)200 mm
TTF03	(A)91×(B)200×(C)200 mm
TTF04	(A)101×(B)200×(C)200 mm
TTF05	(A)121×(B)200×(C)200 mm
TTF06	(A)141×(B)200×(C)200 mm



## U-L-Form Support

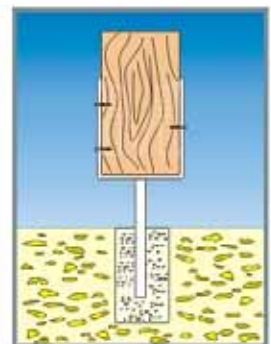
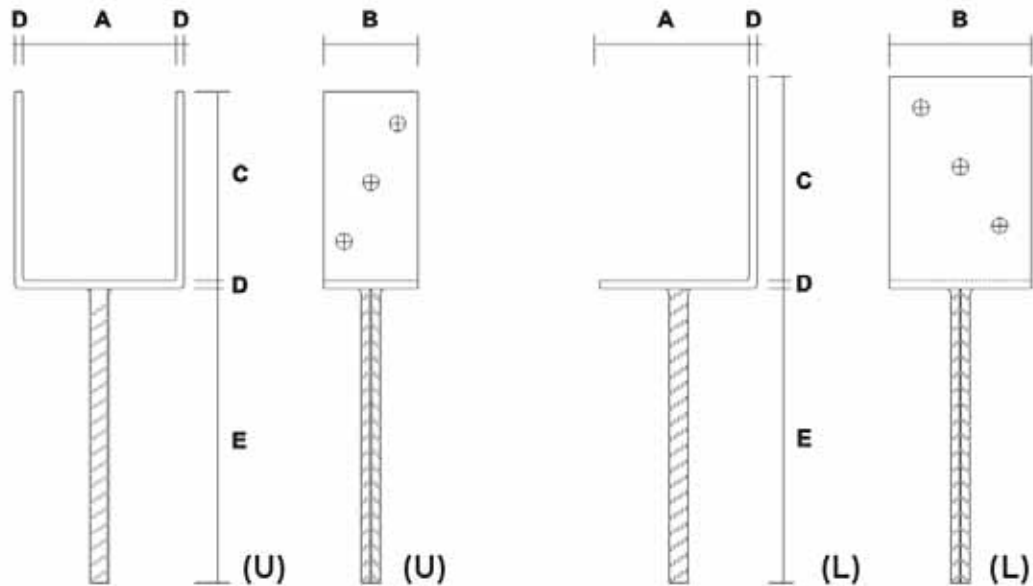

### Type of finish available:

Hot-dip galvanised

Electrical galvanised

**Packing:** in cartons / pallets

UF01 (A)61×(B)60×(C)110/100×(D)Φ4×(E)200 mm

UF02 (A)71×(B)60×(C)110/100×(D)Φ4×(E)200 mm

UF03 (A)81×(B)60×(C)110/100×(D)Φ5×(E)200 mm

UF04 (A)91×(B)60×(C)110/100×(D)Φ5×(E)200 mm

UF05 (A)101×(B)60×(C)110/100×(D)Φ5×(E)200 mm

UF06 (A)121×(B)60×(C)110/100×(D)Φ5×(E)200 mm

LF01 (A)80×(B)90×(C)130×(D)Φ5×(E)200 mm





## T-Form Support

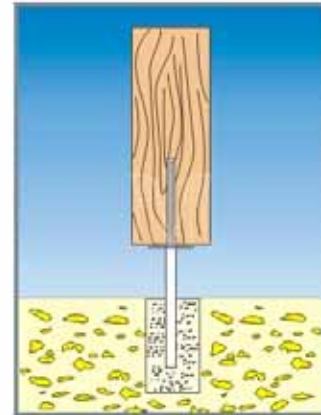
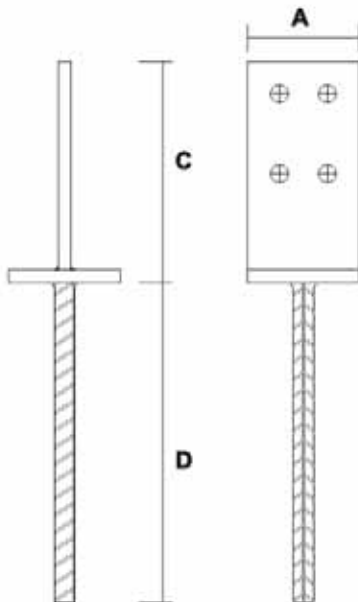

- TF01 (A)70×(B)70×(C)130×(D)200 mm  
TF02 (A)90×(B)90×(C)130×(D)200 mm

## U-Form Support

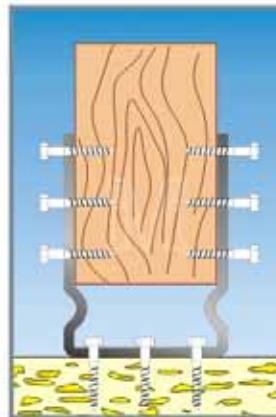

### Type of finish available:

Hot-dip galvanised  
Electrical galvanised

**Packing:** in cartons / pallets

- UP01 (A)71×(B)125/150×(C)60 mm  
UP02 (A)81×(B)125/150×(C)60 mm  
UP03 (A)91×(B)125/150×(C)60 mm  
UP04 (A)101×(B)125/150×(C)60 mm  
UP05 (A)121×(B)125/150×(C)60 mm  
UP06 (A)141×(B)125/150×(C)60 mm





### Wall Starting Support



### U Support





### Adjustable Support

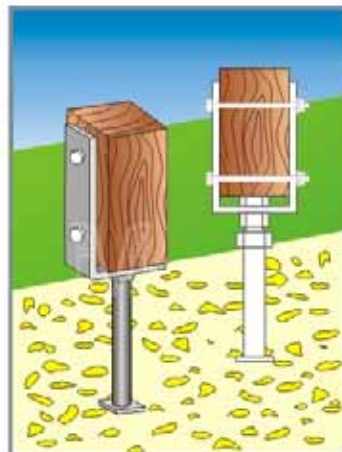
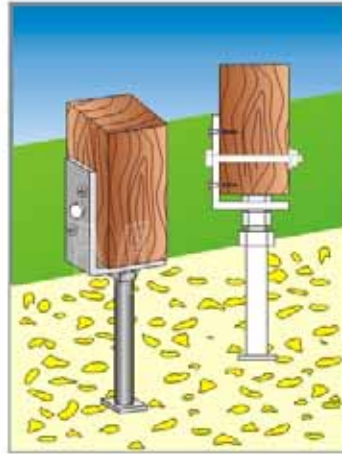

### Solar Panel Support

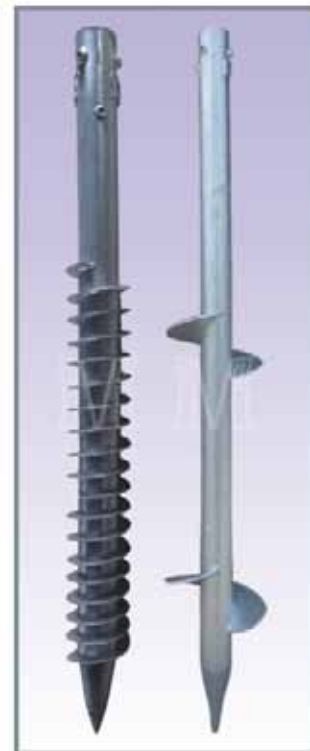

### Steel Bar

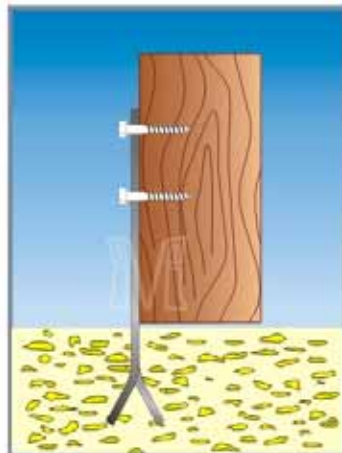



**GREENPOST®**



 **HEBEI MINMETALS CO.,LTD.**

Add: No.337, Xinhua Road, Shijiazhuang ,China  
E-mail: eusales@hebeimetals.com sales@hebeimetals.com  
Home Page: <http://www.hebeiminmetals.com.cn>  
Tel: +86-311-85202701 / 85202702 / 85272699  
Fax: +86-311-85202703 / 85020366