



FELCO Directory



SNIPS

Metal Handles 5

SECATEURS

Ergonomic 7
 Rotating 8
 Standard 9
 Flowers 10
 Spraying 10
 Essential 10
 Elite 11
 Premium 11



HEDGE SHEARS

Hedge Shears 13



LONG REACH PRUNERS

Pruner 15
 Saws 15



LOPPERS

Long reach 17
 Precision 18
 Power 16
 Lever-Action 20
 Heavy-Duty 21



SAWS

Straight 23
 Curved 24



GARDEN TOOLS

Tools 26



GARDEN KNIVES

Garden Knives 28



SPECIAL APPLICATIONS

Hoof Clipping 31
 Universal Cutters 31



CABLE CUTTERS

One-Handed 33
 Two-Handed 34



ACCESSORIES

Sharpening 36
 Maintenance 36
 Holsters 37



PPE

Knee pads 39
 Kneeler 39
 Apron 39
 Gloves 40



SPARE PARTS

Service and Maintenance 43
 F Tech 43



Made in Switzerland by FELCO using 100% renewable energy



Left-handed



Cutting diameter



Average-sized hand



Length



Right-handed



Small hand



Large hand



Weight

FEEL THE FELCO DIFFERENCE

High Efficiency Cutting Heads

Premium quality steel and the heat treatment used guarantees the performance and strength of the cutting and anvil blades.

Ergonomic Tool

Inclined cutting head to reduce the risk of muscular-skeletal injuries and to maximise user comfort.

Sap Groove

The sap groove on the anvil blade prevents the wood sticking when cutting sappy wood.

Wire Cutting Notch

Allows the cutting of small wires without damaging the cutting edge.

Shock Absorption System

Special cushion stops reduce impact at the end of a cut, protecting the hand and wrist.

Precision Adjustment System

Micrometric adjustment system guarantees an optimal adjustment of the cutting head, delivers a clean and precise cut every time.

Forged Aluminium Handles Guaranteed for Life

Lightweight and strong, thanks to special aluminium alloys and advanced precision forging methods.

Rotating Ergonomic Handle

Spreads muscular effort across all fingers, reducing (i) cutting effort and (ii) risk of tendonitis and inflammation.

Designed to Fit Users Hands

The range includes models for small, medium or large hands. Left-handed models are also available in key sizes.







FELCO320

Code: FELCO320

- Metal handles with non-slip coating
- Curved 23 mm nickel-coated steel blade
- Shock absorbers, steel pin spring and glove-friendly closure



154 mm



96 g



Made in Japan,
Guaranteed FELCO Quality

FELCO330

Code: FELCO330

- Drop forged curved carbon steel blades
- Anvil style cut
- Leather strap for perfect fit and enhanced ergonomics
- Handles with PP coating



150 mm



113 g



Made in Taiwan,
Guaranteed FELCO Quality



FELCO321

Code: FELCO321

- Metal handles with non-slip coating
- Straight 35 mm chrome-coated carbon steel blade
- Shock absorbers, steel pin spring and glove-friendly closure



177 mm



110 g



Made in Japan,
Guaranteed FELCO Quality

FELCO322

Code: FELCO322

- Metal handles with non-slip coating
- Straight 48 mm chrome-coated carbon steel blade
- Shock absorbers, steel pin spring and glove-friendly closure



190 mm



112 g



Made in Japan,
Guaranteed FELCO Quality





ERGONOMIC SECATEURS

Common features

- Forged aluminium alloy handles with lifetime guarantee
- High-quality hardened steel blades
- Offset cutting head for efficient pruning
- Sharp cutting edge with wire-cutting notch
- Screw-mounted anvil with sap groove
- Toothed centre nut mechanism easily aligns the blades for a clean, precise cut
- Rubber cushion shock absorbers protects the wrists
- All parts replaceable



FELCO 14

Code: FM14

- Ergonomic design for right-handed users with small hands

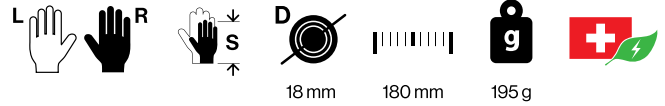

FELCO 16

Code: FELCO16

- Ergonomic design for left-handed users with medium hands

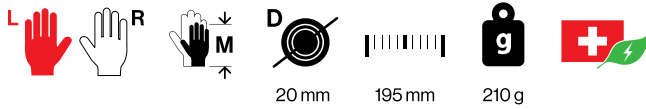

FELCO 6

Code: L75

- Ergonomic design for right-handed users with medium hands

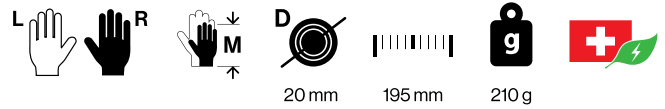

FELCO 9

Code: L133

- Ergonomic design for left-handed users with large hands

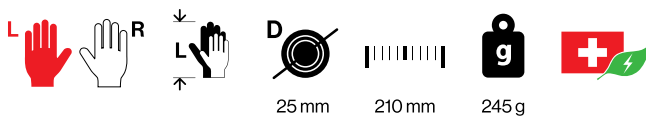

FELCO 8

Code: L117

- Ergonomic design for right-handed users with large hands

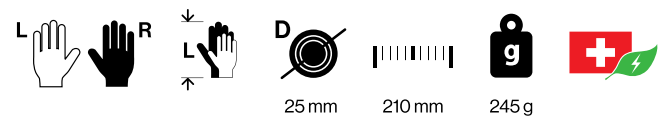

FELCO 13

Code: FM13

- Ergonomic design for one or two-handed use when cutting larger branches

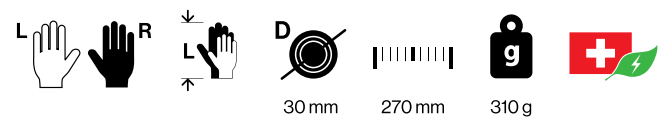

ERGONOMIC ROTATING SECATEURS

Additional features

- Rotating ergonomic secateurs have all the features of the ergonomic range, plus a rotating handle
- Design reduces required user effort by up to one third
- Rotating handles evenly spread muscular force, and help prevent tendonitis and inflammation
- Rotating handle component can be easily removed for cleaning and oiling



FELCO 15

Code: FM15

- Rotating ergonomic design for right-handed users with small hands

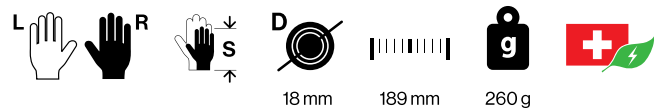

FELCO 17

Code: FELCO17

- Rotating ergonomic design for left-handed users with medium hands

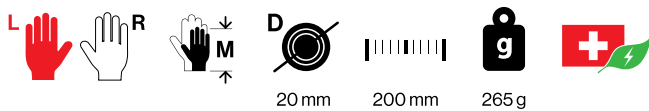

FELCO 12

Code: FM12

- Rotating ergonomic design for right-handed users with medium hands

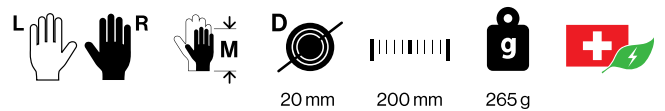

FELCO 10

Code: L562

- Rotating ergonomic design for left-handed users with large hands

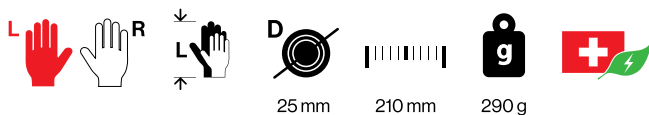

FELCO 7

Code: L91

- Rotating ergonomic design for right-handed users with large hands

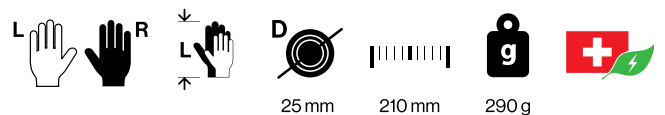

STANDARD SECATEURS

Common features

- Quality materials and precision manufacturing
- High-quality hardened steel blades
- All parts replaceable



FELCO 2

Code: L109

- Original & iconic design for all-round use

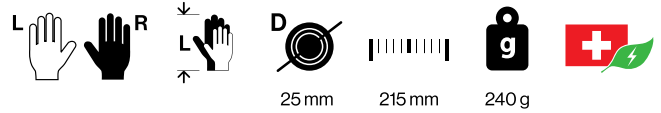

FELCO 4

Code: L125

- Basic design with a simple adjustment mechanism

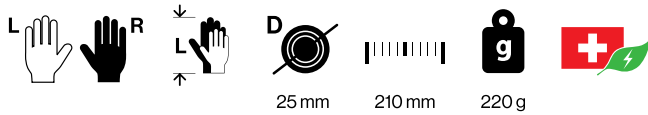

FELCO 11

Code: FM11

- Original design plus a screw-mounted anvil blade

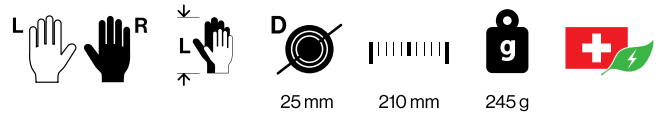

FELCO 31

Code: FM31

- Straight anvil design for cutting hard or dead wood

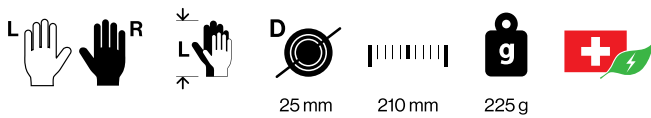

FELCO 32

Code: FM32

- Curved anvil design for cutting hard or dead wood

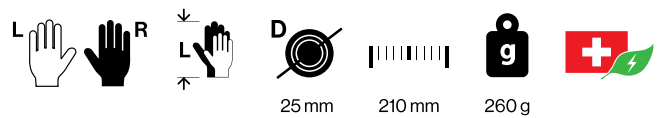

FELCO 5

Code: L83

- Heavy-duty steel design with a simple adjustment mechanism

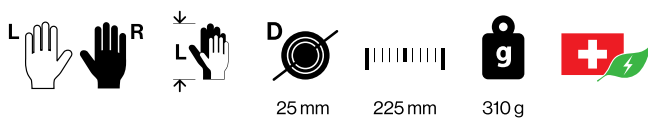

FLOWER PRUNING SECATEURS

Additional features

- Same basic features as standard secateurs
- Cuts and grips flower stems to prevent falling damage



FELCO 100

Code: FM100

- Flower-pruning design with dual aluminium stem grips
- Precision adjustment system

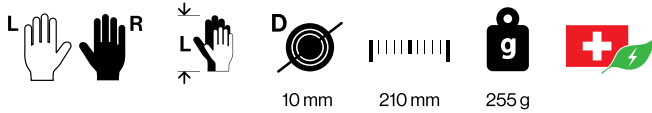

SPRAYING SECATEURS



FELCO 19

Code: LS35006

- Ideal for pruning disease-prone plants
- 1L spray vessel is pressurised using an integrated manual pump
- Disinfects the blade between each cut to prevent disease transfer
- Spray is delivered automatically each time the secateurs close
- Includes sprayer assembly, belt clip and Felco 8 ergonomic secateurs

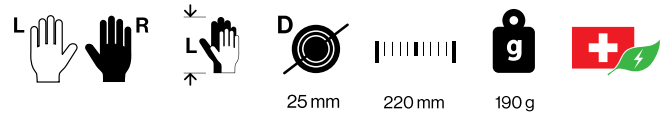

ESSENTIAL SECATEURS

Common features

- Designed for light garden pruning
- Extremely lightweight construction
- High-strength composite fibre handles
- Hardened-steel blade
- Simple blade adjustment system
- Counter blade includes groove
- Phthalate-free non-slip handles



FELCO 160S

Code: 160S

- Lightweight basic design for right-handed users with small hands

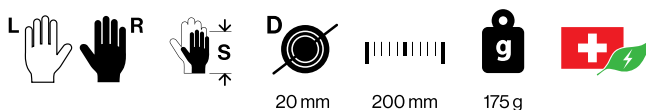

FELCO 160L

Code: 160L

- Lightweight basic design for right-handed users with large hands

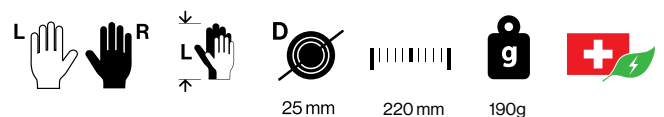

ELITE SECATEURS

Common features

- High quality hardened carbon steel with F Tech coating
- Mid opening thumb catch
- Genuine brown leather covering
- Keyhole ring, in lower aluminum handle allows to fit a lanyard and keep the elite at hand anytime.
- Precision forged aluminum handles
- Easy, durable cutting adjustment
- Sap groove
- Lifetime warranty



FELCO 6

Code: FELCO6ELITE

- Ergonomic design for right handed users with medium hands

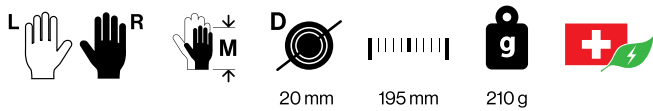

FELCO 8

Code: FELCO8ELITE

- Ergonomic design for right handed users with large hands

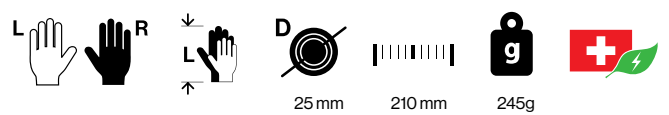

PREMIUM SPECIAL EDITION SECATEURS

Common features

- The landmark forged aluminum handles feature a new black anodization on sandblasted handles
- Hardened steel cutting and anvil blades with black chrome plating
- Handles with black leather covering



FELCO 6

Code: FELCO6PE

- Ergonomic design for right handed users with medium hands

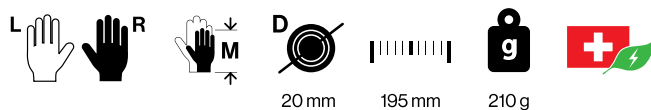

FELCO 8

Code: FELCO8PE

- Ergonomic design for right handed users with large hands

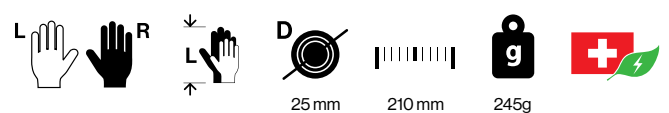

HEDGE SHEARS

FELCO[®]
SWISS  MADE



HEDGE SHEARS

Common features

- Large blade with chrome plated serrated section on the inner blade for wire cutting and thicker branches
- Coating on blades prevents corrosion
- High quality hardened steel blade - 15cm cutting diameter, bypass system
- Blades are bent with a 27 degree angle for improved ergonomics
- Less sharpening of edge required due to the coating on the blades
- Grease bolt for easy maintenance with grease pump
- Ergonomic lightweight and sturdy handles for optimum comfort.
- Phthalate free non-slip, ergonomic grips
- Soft shock absorbers reducing fatigue
- I Beam, extruded aluminum handles are lightweight



FELCO 250-57

Code: FELCO250-57

- 57cm hedge shear designed to meet needs of professional & home gardeners



570mm

10 mm

915 g

FELCO 250-63

Code: FELCO250-63

- 63cm hedge shear designed to meet needs of professional & home gardeners



630mm

10 mm

995 g



LONG REACH PRUNERS



LONG REACH POLE PRUNER

Common features

- Single extension
- Reach 1680mm (Closed) - 2670mm (Extended)
- High quality hardened carbon steel with non-stick coating
- Rotating cutting head - angles 110° to 60°
- Anodized aluminum pole
- Dyneema heavy duty rope



FELCO 290

Code: FELCO290

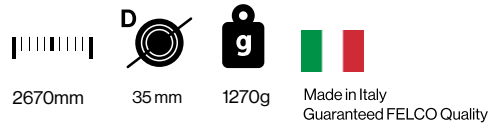

LONG REACH PULL STROKE SAW

Common features

- Pull stroke saw
- High quality Japan hardened steel curved blade with chrome plating
- Optimized geometry of teeth for non-friction cutting and chip evacuation
- Ergonomic soft touch grip and bumper absorbs shocks
- Ergonomic screw with grip for easy mounting of blade
- 2 point extension locking points - pin and clamp

FELCO 682

Code: FELCO682

- Single Extension
- Reach 2070mm (Closed) - 3400mm (Extended)
- Blade length - 330mm
- Supplied with spare 684/3 blade



FELCO 684

Code: FELCO684

- 3 Extensions
- Reach 2300mm (Closed) - 6400mm (Extended)
- Blade length - 390mm
- Hook at top of blade for easy cutting of small branches
- Supplied with spare 630/3 blade



LOPPERS



LONG REACH LOPPERS

Common features

- Large curved cutting head allows the loppers to hook the branches.
- Hardened steel stamped, forged anvil blade.
- Extruded powder-coated aluminum levers offer durability and reliability.
- The non-slip coating gives this lightweight tool a pleasing comfortable grip.
- I-Bean shaped design of the aluminum tubes offer optimum resistance to stress.
- Shock absorbers help reduce fatigue.



FELCO 221-70

FELCO221-70

- Lightweight 70cm design with curved cutting head



45mm 700mm 1160 kg



FELCO 221-80

Code: FELCO221-80

- Lightweight 80cm design with curved cutting head



45mm 800mm 1260 kg



FELCO 221-90

FELCO221-90

- Lightweight 90cm design with curved cutting head

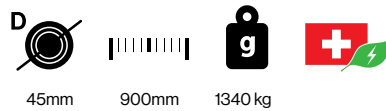

45mm 900mm 1340 kg



PRECISION LOPPERS

Common features

- Cutting head with a slight pulling radius for a clean and precise cut
- Designed for use in tight spaces and among crowded branches
- Excellent durability of the cutting edge
- Robust I-beam aluminium handles
- Phthalate-free non-slip handle grips
- Bypass cutting action
- Rubber shock absorbers to protect hands, wrists and arms
- Easy and precise blade adjustment



FELCO 201-40

Code: FELCO201-40

- Lightweight 40cm design with precision cutting head

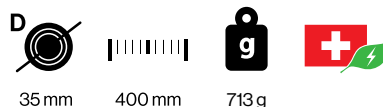

35 mm

400 mm

713 g



FELCO 201-50

Code: FELCO201-50

- Lightweight 50cm design with precision cutting head

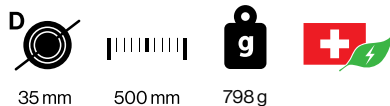

35 mm

500 mm

798 g

FELCO 201-60

Code: FELCO201-60

- Lightweight 60cm design with precision cutting head

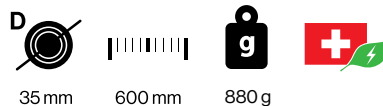

35 mm

600 mm

880 g



POWER LOPPERS

Common features

- Cutting head with an evolving radius for a powerful and smooth cut
- Anvil blade features a deep hook for improved hold
- Robust I-beam aluminium handles
- Phthalate-free non-slip handle grips
- Hardened steel blade and anvil
- Bypass cutting action
- Rubber shock absorbers to protect hands, wrists and arms
- Easy and precise blade adjustment



FELCO 211-40

Code: FELCO211-40

- Lightweight 40cm design with evolving radius cutting head

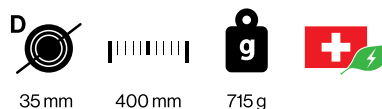

35 mm

400 mm

715 g



FELCO 211-50

Code: FELCO211-50

- Lightweight 50cm design with evolving radius cutting head



35 mm

500 mm

800 g



FELCO 211-60

Code: FELCO211-60

- Lightweight 60cm design with evolving radius cutting head



35 mm

600 mm

885 g



LEVER-ACTION LOPPERS

Common features

- Lever mechanism greatly increases cutting power and reduces effort
- Lightweight, high resistance tubular aluminium alloy handles and non-slip coating
- Wide blade opening, cuts branches with minimum effort
- Blades are made of high-quality steel
- Anvil made of high quality forged aluminium
- Easy adjustment of the blades for a clean, precise cut
- Safety stop prevents finger pinching at the end of the cutting action



FELCO 220

Code: FELCO220

- Cam-assisted 80cm design with curved bypass cutting head
- Shock absorbers to protect hands, wrists and arms



FELCO 230

Code: FELCO230

- Cam-assisted 80cm design with straight anvil cutting head
- Anvil design for cutting hard or dead wood



FELCO 231

Code: FELCO231

- Cam-assisted 80cm design with curved anvil cutting head
- Anvil design for cutting hard or dead wood

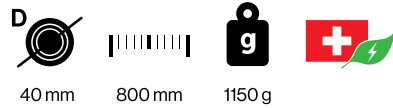

HEAVY-DUTY LOPPERS

Common features

- Heavy-duty forged aluminium handles
- Bypass cutting action
- Hardened steel blade and counter blade
- Counter blade includes sap groove
- Toothed nut for easy adjustment of cutting head
- Rubber shock absorbers help protect hands, wrists and arms
- Phthalate-free non-slip handle grips



FELCO 20

Code: FELCO20

- Heavy-duty yet compact design



35 mm 430 mm 830 g



FELCO 21

Code: FELCO21

- Heavy-duty design



35 mm 630 mm 1130 g



FELCO 22

Code: FM22

- Heavy-duty design with wider blade opening
- Long handles increase cutting power

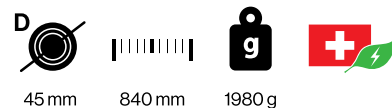

45 mm 840 mm 1980 g





STRAIGHT SAWS

Common features

- Comfortable non-slip handle
- Rust resistant hard-chromed blade made of high-quality steel
- Heat treatment of teeth to ensure a precise, clean cut
- Conical blade shape ensures the saw cuts without clogging
- Set and shape of teeth prevents sap build up
- Replacement blades available



FELCO 600

Code: F600

- 160mm straight pull-stroke blade
- Folding design with locking mechanism

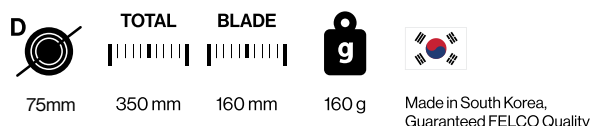

FELCO 600 Replacement Blade

Code: 600/3



FELCO 601

Code: FELCO601

- 120mm straight pull-stroke blade
- Folding design with locking mechanism

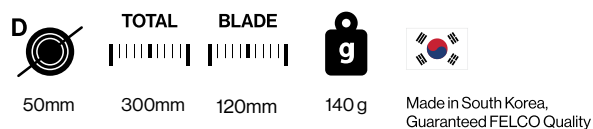

FELCO 601 Replacement Blade

Code: 601/3

FELCO 602

Code: FELCO602

- 160mm straight pull-stroke blade
- Includes sheath and detachable belt loop

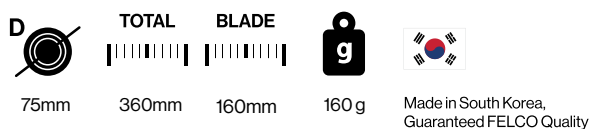

FELCO 602 Replacement Blade

Code: 602/3



FELCO 621

Code: F621

- 240mm straight pull-stroke blade
- Includes sheath and detachable belt loop



FELCO 621 Replacement Blade

Code: 621/3

FELCO 611

Code: F611

- 330mm straight pull-stroke blade
- Includes sheath and detachable belt loop

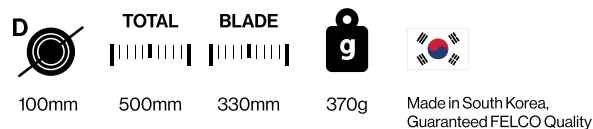

FELCO 611 Replacement Blade

Code: 611/3

CURVED SAWS

Additional features

- Curved shape for easier cutting, even with overhead branches
- Blade shape and handle design help absorb vibration
- Upgraded sheath with additional safety features



FELCO 603

Code: FELCO603

- 200mm curved pull-stroke blade
- Folding design with locking mechanism

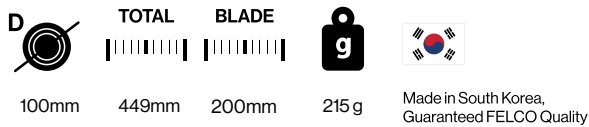

FELCO 604

Code: FELCO604

- 240mm curved pull-stroke blade
- Folding design with locking mechanism

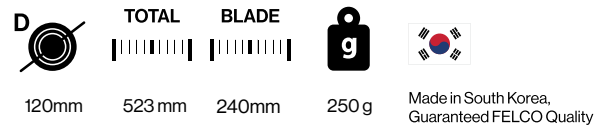

FELCO 603 Replacement Blade

Code: 603/3

FELCO 604 Replacement Blade

Code: 604/3



FELCO 630

Code: F630

- 330mm curved pull-stroke blade
- Includes locking sheath, Velcro leg strap and detachable belt loop



FELCO 640

Code: F640

- 270mm curved pull-stroke blade
- Includes locking sheath, Velcro leg strap and detachable belt loop

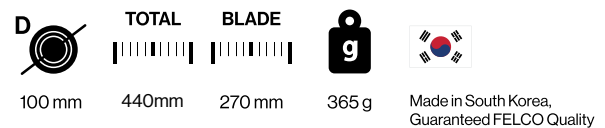

FELCO 630 Replacement Blade

Code: 630/3

FELCO 640 Replacement Blade

Code: 640/3



GARDEN HAND TOOLS

Common features

- Ash wood handle
- Forged Baron steel and hardened steel



FELCO 401 - HAND TROWEL

Code: FELCO401

- Perfect at digging holes for planting seeds, plants and flowers



330mm



240 g



Made in the Netherlands
Guaranteed FELCO Quality



FELCO 411 - HAND CULTIVATOR

Code: FELCO411

- Breaks up soil and prepares garden beds for planting



330mm



180 g



Made in the Netherlands
Guaranteed FELCO Quality



FELCO 421 - HAND WEEDER

Code: FELCO421

- Removing weeds in vegetable gardens, fruit tree basins and around vineyard planting



290mm



150g



Made in the Netherlands
Guaranteed FELCO Quality



FELCO 431 - HAND FORK

Code: FELCO431

- Perfect for aerating soil and turning compost



290mm



200 g



Made in the Netherlands
Guaranteed FELCO Quality



FELCO 441 - SWISS HORI HORI

Code: FELCO441

- Essential to dig up tap rooted weeds in lawns and gardens



280mm



190 g



Made in the Netherlands
Guaranteed FELCO Quality





GARDEN KNIVES

Common features

- Inner brass lining to eliminate friction during opening and closing of blade
- Brass rivets for high rigidity



FELCO 511 - PRUNING AND GRAFTING KNIFE

Code: FELCO511

- High quality carbon steel blade
- Curved blade, ground on one side with slight chamfer on the back for perfect grafting
- American walnut handle
- 60mm blade

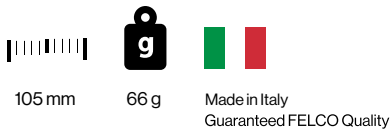

FELCO 512 - BUDDING AND GRAFTING KNIFE

Code: FELCO512

- High quality carbon steel blade
- Large straight blade, ground on one side with slight chamfer on the back for perfect grafting
- Bark lifter on blade
- American walnut handle
- 58mm blade

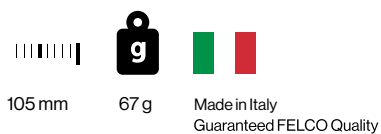

FELCO 520 - FLORIST KNIFE

Code: FELCO520

- High quality carbon steel blade
- Straight blade, ground on one side with slight chamfer on the back
- Plastic handle
- 62mm blade

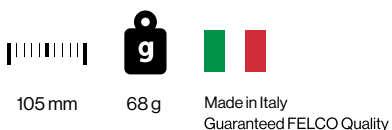

GARDEN KNIVES

Common features

- A Swiss collaboration, made by Victorinox
- Small and strong design
- Red nylon handle with alloy lining
- Stainless steel blades with bevel
- Right-handed tool

3.90 10

Code: 39010

- Light budding knife
- 51mm stainless steel blade



100 mm



34 g



Made in Switzerland,
Guaranteed FELCO Quality



3.90 20

Code: 39020

- Rose budding knife
- 57mm stainless steel blade
- Integrated bark lifter



100 mm



35 g



Made in Switzerland,
Guaranteed FELCO Quality



3.90 40

Code: 39040

- Fruit tree budding knife
- 44mm stainless steel blade
- Integrated bark lifter



100 mm



51 g



Made in Switzerland,
Guaranteed FELCO Quality



3.90 50

Code: 39050

- Straight grafting knife
- 57mm stainless steel blade



100 mm



55 g



Made in Switzerland,
Guaranteed FELCO Quality



3.90 60

Code: 39060

- Curved grafting knife
- 57mm stainless steel blade



100 mm



52 g



Made in Switzerland,
Guaranteed FELCO Quality



3.91 10

Code: 39110

- All-purpose budding knife
- 51mm stainless steel blade
- 32mm brass bark opener



100 mm



44 g



Made in Switzerland,
Guaranteed FELCO Quality





SHEEP & GOAT HOOF CLIPPERS

Additional features

- Same basic features as ergonomic secateurs
- Shaped specifically for clipping the hooves of sheep and goats
- Agile angled cutting head for faster and more comfortable clipping
- XYLAN® coating keeps the blades cleaner to protect against spreading hoof infections



FELCO 50

Code: L18

- Rotating ergonomic design for hoof clipping



FELCO 51

Code: L26

- Ergonomic design for hoof clipping



UNIVERSAL CUTTERS



FELCO CP

Code: CP

- Heavy-duty design for precise cutting of wood, paper, cardboard, wire, sheet metal, mesh, packing strips, rubber and plastic

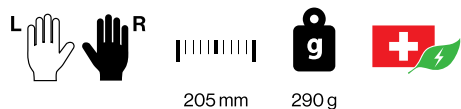



ONE-HANDED CABLE CUTTERS

Common features

- One-handed cable cutters
- Blades and centre bolt made from high-quality hardened steel
- Thumb catch designed and positioned for one-hand use
- Pressed steel handles with non-slip grips
- Triangular cutting system gives a clean cut without squashing cables



FELCO C3

Code: C3

- One-handed design for cutting wire and cables up to 3mm diameter

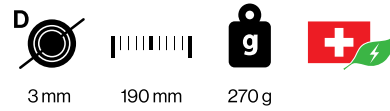

FELCO C7

Code: C7

- One-handed design for cutting wire and cables up to 7mm diameter

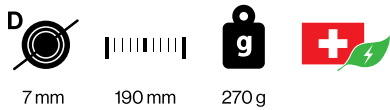

FELCO CDO

Code: CDO

- Designed for cutting barbed wire

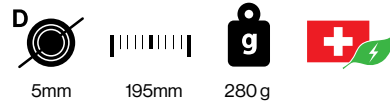

TWO-HANDED CABLE CUTTERS

Common features

- Two-handed cable cutters
- Triangular cutting system gives a clean cut without squashing cables
- Hardened handles made from forged aluminium with a lifetime guarantee
- Easy and durable cutting adjustment
- Blades and fastenings made from high-quality hardened steel
- Heavy-duty forged aluminium handles with coated grips



FELCO C9

Code: C9

- Two-handed design for cutting cables up to 9mm diameter

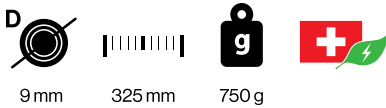

FELCO C12

Code: C12

- Two-handed design for cutting cables up to 12mm diameter

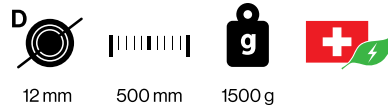

FELCO C16

Code: C16

- Two-handed design for cutting cables up to 16mm diameter

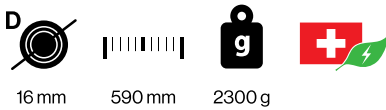

FELCO C16E

Code: C16E

- Two-handed design for cutting electrical cables up to 16mm diameter
- Specific blade geometry for electrical cables
- Power supply must be switched off first

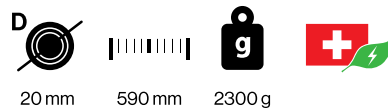

FELCO C108

Code: C108

- Two-handed design for cutting steel cables up to 8mm diameter
- Force transmission system with cam device for increased cutting power
- Blades and fastenings phosphate-treated for corrosion resistance

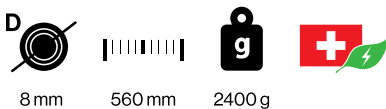

FELCO C112

Code: C112

- Two-handed design for cutting steel cables up to 12mm diameter
- Force transmission system with cam device for increased cutting power
- Blades and fastenings phosphate-treated for corrosion resistance

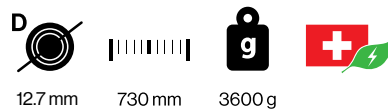



SHARPENING TOOLS

High-quality sharpening made pocket-sized. These sharpening tools ensure a precise cut, a longer life for blades and minimise the required cutting effort.



FELCO 905

Code: FELCO905

- Easy sharpening with fixed-angle carbide stone
- Integrated secateur adjustment tool



107mm



39 g



Made in China,
Guaranteed FELCO Quality



FELCO 906

Code: FELCO906

- Casted aluminum handle
- Carbide stone can be reversed for longer durability
- Hole for keyring



107mm



39 g



Made in China,
Guaranteed FELCO Quality



FELCO 902

Code: F90

- High purity corundum
- Medium grained (blue side)
- Fine grained (white side)



100 mm



30 g



Made in China,
Guaranteed FELCO Quality



FELCO 903

Code: FELCO903

- Diamond-coated hardened steel
- Designed to reach all areas while sharpening



100 mm



50 g



Made in Switzerland,
Guaranteed FELCO Quality



FELCO 904

Code: FELCO904

- Tungsten steel sharpener



135 mm



60 g



Made in Switzerland,
Guaranteed FELCO Quality

MAINTENANCE PRODUCTS

The only sprays you will need to maintain your secateurs, loppers and cable cutters. Keep your working parts clean and moving smoothly.



FELCO 981

Code: FELCO981

- 110ml of cleaning spray
- Safely cleans and removes plant resin
- Free of Volatile Organic Compounds (VOC)



Made in Germany,
Guaranteed FELCO Quality



FELCO 980

Code: FELCO980

- 56ml of lubricant spray
- Safely lubricates and protects cutting heads
- Free of Volatile Organic Compounds (VOC)



Made in Switzerland,
Guaranteed FELCO Quality



FELCO 990

Code: FELCO990

- 30 g of biodegradable synthetic grease
- Safely lubricates large moving parts
- Free of Volatile Organic Compounds (VOC)



Made in Germany,
Guaranteed FELCO Quality

TOOL HOLSTERS

Designed especially for Felco tools, these quality holsters are made with genuine leather, heavy-duty stitching and polished steel rivets.



FELCO 910

Code: F910

- Genuine leather holster with a belt loop and clip



235 mm



110 g



Made in India,
Guaranteed FELCO Quality



FELCO 910+

Code: F910+

- Genuine leather holster with a belt loop and clip
- Side holster for a sharpening tool



235 mm



120 g



Made in USA,
Guaranteed FELCO Quality



FELCO 911

Code: F911

- Genuine leather holster with a belt loop and clip
- Double holster holds two secateurs, or a secateur and small folding saw



285 mm



195 g



Made in USA,
Guaranteed FELCO Quality



FELCO 912

Code: F912

- Genuine leather holster with a clip



150 mm



65 g



Made in India,
Guaranteed FELCO Quality



FELCO 921

Code: F921

- Genuine leather holster with a belt loop and clip
- Double holster holds two secateurs, or a secateur and small folding saw



255 mm



215 g



Made in USA,
Guaranteed FELCO Quality



FELCO 923

Code: F923

- Genuine leather holster with a belt loop and clip
- Long holster designed for FELCO 13, or those with longer arms



285 mm



135 g



Made in USA,
Guaranteed FELCO Quality



FELCO 711 - KNEE PADS

Code: FELCO711

Common features

- High quality and comfortable knee pads
- Two straps for better fitting on the knees
- Large lower breathable neoprene strap keeps knee pad in place
- Gel foam offers lightweight cushion for all day comfort
- Slip resistant ultra durable nylon rubber soft cap allows to perform pruning activities under all weather conditions



Made in China,
Guaranteed FELCO Quality

FELCO 712 - KNEELER

Code: FELCO712

Common features

- High density NBR foam rubber that will not compress overtime for long lasting protection against hard surfaces
- Water and petroleum resistant for dry comfort on wet surfaces
- Lightweight with built in handle for convenient transportation
- Texture on top and bottom grips to flooring and prevents knees from sliding on panel



Made in Taiwan
Guaranteed FELCO Quality

FELCO 490 - APRON

Code: FELCO490

Common features

- High quality gardening apron
- Adjustable neck strap
- Adjustable hip strap
- Apron has been designed to fit above the knee for maximum movement and comfort
- Pocket for notebook or cellphone
- Pocket for pen
- Pruning shear pocket with double liners for increased resistance to perforation
- Pocket for plant markers or other accessories
- Pocket for gardening tool



730mm



390g



Made in Pakistan,
Guaranteed FELCO Quality

GLOVES



FELCO 701

Small Code: FELCO701S

Medium Code: FELCO701M

Large Code: FELCO701L

Extra Large Code: FELCO701XL

- Lightweight garden glove
- Stretchy and comfortable fit
- Protective nitrile coating
- CE, EN420 & EN388:2016 (4443X)



S/M/L/XL

Made in China,
Guaranteed FELCO Quality



FELCO 702

Small Code: FELCO702S

Medium Code: FELCO702M

Large Code: FELCO702L

Extra Large Code: FELCO702XL

- Leather-palmed work glove
- Protective PVC patches for extra grip
- Breathable and stretchy Spandex backing
- CE, EN420 & EN388:2016 (2121X)



S/M/L/XL

Made in Pakistan,
Guaranteed FELCO Quality



FELCO 703

Small Code: FELCO703S

Medium Code: FELCO703M

Large Code: FELCO703L

Extra Large Code: FELCO703XL

- Premium full-leather glove
- Close and comfortable fit
- Natural tan colour
- CE, EN420 & EN388:2016 (2132X)



S/M/L/XL

Made in Pakistan,
Guaranteed FELCO Quality

FELCO 704

Small Code: FELCO704S

Medium Code: FELCO704M

Large Code: FELCO704L

Extra Large Code: FELCO704XL

XX Large Code: FELCO705XXL

- Designed to prevent risk of light cuts when pruning with a manual shear or pull stroke saw
- Soft and durable synthetic leather palm providing excellent grip
- Mesh lined cut resistant fibers protect top of fingers
- Elastic and flexible neoprene backing and breathable mesh on thumb



S/M/L/XL/XXL



Made in China,
Guaranteed FELCO Quality

FELCO 705

Small Code: FELCO705S

Medium Code: FELCO705M

Large Code: FELCO705L

Extra Large Code: FELCO705XL

- Premium puncture resistant leather - soft, flexible and strong
- Gantlet cuff made from Suede leather protect the forearm from thorns
- Elastic closure on cuff for better fit
- Cuff equipped with nylon strap and non metallic buckle so that it remains in place



S/M/L/XL



Made in Pakistan,
Guaranteed FELCO Quality





FELCO 933 SERVICE AND MAINTENANCE KIT

Code: FELCO933

Kit Contains:-

- FELCO 2 pruning shear
- Spare Blade 2/3
- FELCO 980 Lubricating Spray
- FELCO 981 Sap Remover
- FELCO 990 Grease
- FELCO 905 Sharpener
- Adjustment Key 2/30
- Cleaning towel



F TECH TECHNOLOGY

The new F Tech blade technology brings incremental performance enhancements to our core range of cutting blades. The outcome of this innovative high performance and cutting-edge technology is as significant reduction in friction between the blade, counter blade and the branch when cutting, the added benefit is that less effort required when pruning. The coating also significantly reduces sap and potential bacteria adhesion to the blade.

- Effortless cutting even with the thickest and hardest wood
- Clean and precise cuts without straining hand or wrists
- Enhanced efficiency
- Achieve professional quality cuts with ease



2/3 FTECH

F Tech Blade for FELCO 2, 4, 11
Code: 2/3FTECH



6/3 FTECH

F Tech Blade for FELCO 6, 12
Code: 6/3FTECH



7/3 FTECH

F Tech Blade for FELCO 7, 8
Code: 7/3FTECH



14/3 FTECH

F Tech Blade for FELCO 14, 15
Code: 14/3FTECH



30/3 FTECH

F Tech Blade for FELCO 31
Code: 30/3FTECH

All FELCO parts are replaceable.

Replacement Cutting Blades

Replacement Anvil Blades

Replacement Springs

Replacement Nut & Bolt Set

Available for most models, see price list for full details

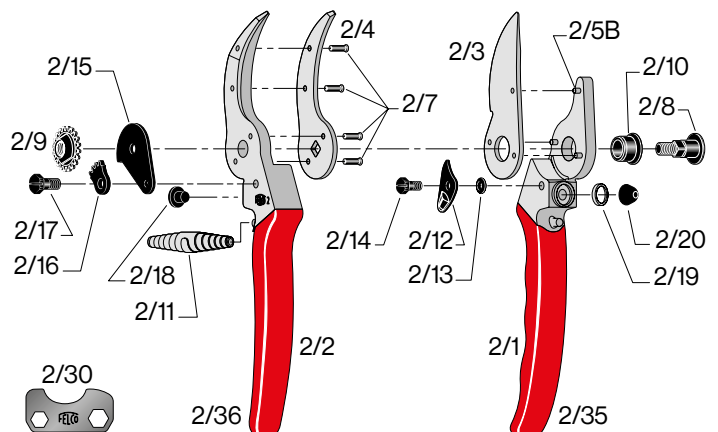

Contact Details

Burton McCall Limited
163 Parker Drive, Leicester, LE4 0JP

Tel Main Switchboard: 0116 234 4600
www.burton-mccall.co.uk

f @BTNMCCALL
@ @burtonmccallltd
in @burton-mccall-limited

Sales Office

Tel: 0116 234 4611/4622
Email: sales@burton-mccall.com

Customer Services

Tel: 0116 234 4646
Email: customer.services@burton-mccall.com

