



# ***TIANCHENG TOOLS***



The reason why our products enjoys  
high reputation among the clients  
lies on its principle: high quality,  
competitive price and in-time delivery.  
Your support is a must for our growth.  
Hope you can find your needs in  
tiancheng tools.

**SHAOXING TIANCHENG TOOL CO.,LTD.**

**SHAOXING TIANCHENG TOOL CO.,LTD.**

Add: Industry Zone, Yonghe Town, Shangyu District, Shaoxing City, Zhejiang  
Province, China(312371)  
FAX: 0086-575-82932988  
E-mail: luck@tianchengtools.com

TEL: 0086-575-82930988 82933088  
<http://www.tianchengtools.com>  
tianchengtools@126.com

# Brief Introduction

The former company was a production base that specially produced all kinds of riveter, wrenches, spare parts for cars, plastic spare parts and gardening tools of Japanese, French, British, Germany, American and some other style. It has been mainly engaged in exporting of hardware in more than twenty years' time. On the fast changed market, the company decided to display a complete new look to the customers in 2025 in order to ensure our customers' long-term support: excellent quality, economical price and considerate services in time; persistence on our Managing Identity Honesty and Credit.

The company has the ability of designing, molding, pressing and casting, injection, rush press into shape, forging, cutting process, spraying lacquer, inspection and assembly. The production facility is complete as the inspection devices. The company consists on the aim "Quality First, Credit Supreme" and persistently pursues technology innovation and development of new products to satisfy domestic customers' need, so that it is thought highly by the customers. On the purpose of further developing international market, welcome customers at home and abroad to visit, guide and cooperate!

# Content

HAND RIVETER.....	P1
GECKO RIVETER.....	P12
RATCHET TAP.....	P12
ADAPTOR.....	P13
CORDLESS RIVETER.....	P14
RATCHET WRENCH.....	P15
PACKING.....	P19





Material: Aluminium



PVC Handle



Suitable for  
3.2-4.0-4.8mm  
(1/8", 5/32", 3/16")  
Aluminum Rivets and  
Stainless Rivets

**TSB4901 415mm(16.5")**  
**JAPAN Style Riveter**

Packing	Inner ctn/outer ctn(pc)	G.w/n.w(kg)	Pack measurement(cm)
COLOR BOX	20	21.8/20.8	47X38.5X22.5



Material: Aluminium



PVC Handle



Suitable for  
3.2-4.0-4.8mm  
(1/8", 5/32", 3/16")  
Aluminum Rivets and  
Stainless Rivets

**TSB4901H 415mm(16.5")**  
**JAPAN Style Riveter**

Packing	Inner ctn/outer ctn(pc)	G.w/n.w(kg)	Pack measurement(cm)
COLOR BOX	6/12	14.5/13.2	49X27X27



Material: Aluminium



PVC Handle



Suitable for  
3.2-4.0-4.8mm  
(1/8", 5/32", 3/16")  
Aluminum Rivets and  
Stainless Rivets

**TSB4901H - 1 415mm(16.5")**  
**JAPAN Style Riveter**

Packing	Inner ctn/outer ctn(pc)	G.w/n.w(kg)	Pack measurement(cm)
COLOR BOX	6/12	14.5/13.2	49X27X27



Material: Aluminium



PVC Handle



Suitable for  
3.2-4.0-4.8mm  
(1/8", 5/32", 3/16")  
Aluminum Rivets and  
Stainless Rivets

**TSB4905 430mm(17")**  
**EUROPEAN & U.S.A.Style Riveter**

Packing	Inner ctn/outer ctn(pc)	G.w/n.w(kg)	Pack measurement(cm)
COLOR BOX	10	14/13	49.5X21X36.5





Material: Carbon Steel



PVC Handle

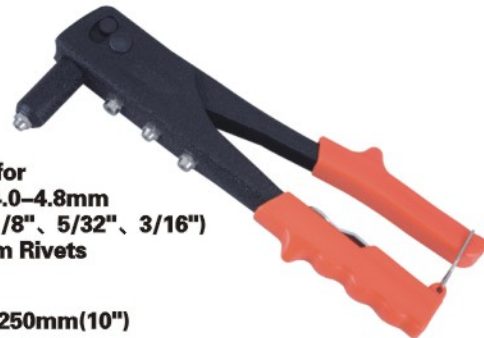

Suitable for  
2.4-3.2-4.0-4.8mm  
(3/32", 1/8", 5/32", 3/16")  
Aluminum Rivets

**TT4201 250mm(10")**  
JAPAN Style Riveter

Packing	Inner ctn/outer ctn(pc)	G.w/n.w(kg)	Pack measurement(cm)
PLASTIC BAG	0/40	23/22	36.5X29.5X22
BLISTER CARD	12/24	15.7/14.5	37X37X23
DOUBLE BLISTER	12/24	16/14.8	36.5X29.1X34.5
BLISTER CARD WITH 60 RIVETS	6/24	18.2/17	43X38X32
PLASTIC BOX WITH 60 RIVETS	5/20	17.4/16.2	34.5X34X43.5



Material: Carbon Steel



PVC Handle



Suitable for  
2.4-3.2-4.0-4.8mm  
(3/32", 1/8", 5/32", 3/16")  
Aluminum Rivets

**TT4201H 250mm(10")**  
Heavy-duty EUROPEAN Style Riveter

Packing	Inner ctn/outer ctn(pc)	G.w/n.w(kg)	Pack measurement(cm)
BLISTER CARD	12/24	16.2/15	40.5X37X23
PVC BOX	6/24	16.2/15	59.5X24.5X28



Material: Carbon Steel



PVC Handle



Suitable for  
2.4-3.2-4.0-4.8mm  
(3/32", 1/8", 5/32", 3/16")  
Aluminum Rivets

**TT4202H 240mm(9.5")**  
JAPAN Style Riveter

Packing	Inner ctn/outer ctn(pc)	G.w/n.w(kg)	Pack measurement(cm)
BLISTER CARD	12/24	15.2/14	37X37X23



Material: Carbon Steel

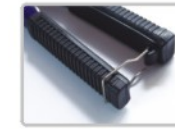

PVC Handle



Suitable for  
2.4-3.2-4.0-4.8mm  
(3/32", 1/8", 5/32", 3/16")  
Aluminum Rivets

**TT4202-1 240mm(9.5")**  
European Style Riveter

Packing	Inner ctn/outer ctn(pc)	G.w/n.w(kg)	Pack measurement(cm)
BLISTER CARD	12/24	15.2/14	37X37X23



Material: Carbon Steel

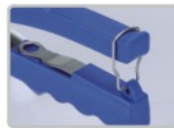

PVC Handle



Suitable for  
2.4-3.2-4.0-4.8mm  
(3/32", 1/8", 5/32", 3/16")  
Aluminum Rivets

**TT4210 250mm(10")**  
European Style Riveter

Packing	Inner ctn/outer ctn(pc)	G.w/n.w(kg)	Pack measurement(cm)
PLASTIC BAG	0/40	23/22	36.5X29.5X22
BLISTER CARD	12/24	15.7/14.5	37X37X23
DOUBLE BLISTER	12/24	16/14.8	36.5X29.1X34.5
BLISTER CARD WITH 60 RIVETS	6/24	18.2/17	43X38X32
PLASTIC BOX WITH 60 RIVETS	5/20	17.4/16.2	34.5X34X43.5



Material: Carbon Steel



PVC Handle



Suitable for  
2.4-3.2-4.0-4.8mm  
(3/32", 1/8", 5/32", 3/16")  
Aluminum Rivets

**TT4202 240mm(9.5")**  
U.S.A.Style Riveter

Packing	Inner ctn/outer ctn(pc)	G.w/n.w(kg)	Pack measurement(cm)
BLISTER CARD	12/24	15.2/14	37X37X23
PLASTIC BOX WITH 60 RIVETS	5/20	17/15.8	34.5X34X43.5



Material: Carbon Steel

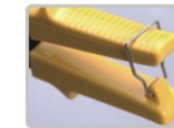

PVC Handle



Suitable for  
2.4-3.2-4.0-4.8mm  
(3/32", 1/8", 5/32", 3/16")  
Aluminum Rivets

**TT4203 260mm(10.5")**  
U.S.A.Style Riveter

Packing	Inner ctn/outer ctn(pc)	G.w/n.w(kg)	Pack measurement(cm)
BLISTER CARD	6/24	16.2/15	36.7X25.9X39



Material: Carbon Steel



PVC Handle



Suitable for  
2.4-3.2-4.0-4.8mm  
(3/32", 1/8", 5/32", 3/16")  
Aluminum Rivets

**TT4203-1 260mm(10.5")**  
Heavy-duty JAPAN Style Riveter

Packing	Inner ctn/outer ctn(pc)	G.w/n.w(kg)	Pack measurement(cm)
BLISTER CARD	6/24	16.2/15	36.7X25.9X39



Material: Carbon Steel



PVC Handle



Suitable for  
2.4-3.2-4.0-4.8mm  
(3/32", 1/8", 5/32", 3/16")  
Aluminum Rivets

**TT4204 228mm(9")**  
**TAIWAN Style Riveter**

Packing	Inner ctn/outer ctn(pc)	G.w/n.w(kg)	Pack measurement(cm)
BLISTER CARD	12/24	13.6/12.4	37X33X23.5
BLISTER CARD WITH 60 RIVETS	6/24	16.5/15.5	37X36.5X37



Material: Carbon Steel



PVC Handle



Suitable for  
2.4-3.2-4.0-4.8mm  
(3/32", 1/8", 5/32", 3/16")  
Aluminum Rivets

**TT4205 250mm(10")**  
**Bidirectional U.S.A.Style Riveter**

Packing	Inner ctn/outer ctn(pc)	G.w/n.w(kg)	Pack measurement(cm)
BLISTER CARD	12/24	20/18.8	42.5X38.5X23



Material: Aluminium



Material: Carbon Steel



PVC Handle



Suitable for  
2.4-3.2-4.0-4.8mm  
(3/32", 1/8", 5/32", 3/16")  
Aluminum Rivets

**TB4802 240mm(9.5")**  
**ENGLAND Style Riveter**

Packing	Inner ctn/outer ctn(pc)	G.w/n.w(kg)	Pack measurement(cm)
BLISTER CARD	12/24	15.4/14.2	38X33X25
DOUBLE BLISTER	5/20	15.4/14.2	36.5X28.1X32.4



Material: Aluminium



PVC Handle



Material: Carbon Steel



Suitable for  
2.4-3.2-4.0-4.8mm  
(3/32", 1/8", 5/32", 3/16")  
Aluminum Rivets

**TL4501-1 260mm(10.5")**  
**GERMANY Style Aluminium Riveter**

Packing	Inner ctn/outer ctn(pc)	G.w/n.w(kg)	Pack measurement(cm)
BLISTER CARD	12/24	13/11.8	37X37X23
BLISTER CARD WITH 60 RIVETS	6/24	15.6/14.4	40.5X35X31
DOUBLE BLISTER	6/24	13.8/12.6	37.5X28.7X38
PLASTIC BOX WITH 60 RIVETS	5/20	15.7/14.5	34X33.5X42



Material: Carbon Steel



PVC Handle



Suitable for  
2.4-3.2-4.0-4.8mm  
(3/32", 1/8", 5/32", 3/16")  
Aluminum Rivets

**TT4209 260mm(10.5")**  
**HOLLAND Style Riveter**

Packing	Inner ctn/outer ctn(pc)	G.w/n.w(kg)	Pack measurement(cm)
COLOR BOX	0/24	20.1/18.9	41.5X29X20.2



Material: Carbon Steel



PVC Handle



Suitable for  
2.4-3.2-4.0-4.8mm  
(3/32", 1/8", 5/32", 3/16")  
Aluminum Rivets

**TT4206 265mm(10.5")**  
**Heavy-duty Riveter**

Packing	Inner ctn/outer ctn(pc)	G.w/n.w(kg)	Pack measurement(cm)
BLISTER CARD	5/20	15.9/14.7	37.5X31.5X39



Material: Aluminium



PVC Handle



Material: Carbon Steel



Suitable for  
2.4-3.2-4.0-4.8mm  
(3/32", 1/8", 5/32", 3/16")  
Aluminum Rivets

**TL4503-1 260mm(10.5")**  
**Heavy-duty TAIWAN Style Riveter**

Packing	Inner ctn/outer ctn(pc)	G.w/n.w(kg)	Pack measurement(cm)
BLISTER CARD	12/24	15.2/14	37X37X23
DOUBLE BLISTER	6/24	15.2/14	36.5X35.5X38



Material: Aluminium



PVC Handle

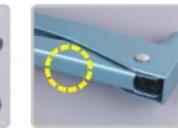

Material: Carbon Steel



Suitable for  
2.4-3.2-4.0-4.8mm  
(3/32", 1/8", 5/32", 3/16")  
Aluminum Rivets

**TL4108 260mm(10.5")**  
**JAPAN Style Aluminium Riveter**

Packing	Inner ctn/outer ctn(pc)	G.w/n.w(kg)	Pack measurement(cm)
BLISTER CARD	12/24	13.5/12.3	40.5X37X23



Material: Aluminium PVC Handle Material: Carbon Steel



Suitable for  
2.4-3.2-4.0-4.8mm  
(3/32", 1/8", 5/32", 3/16")  
Aluminum Rivets

**TL4102 265mm(10.5")**  
**ENGLAND Style Aluminium Riveter**

Packing	Inner ctn/outer ctn(pc)	G.w/n.w(kg)	Pack measurement(cm)
BLISTER CRAD	12/24	14.9/13.7	37X37X23
DOUBLE BLISTER	6/24	15.2/14	38.5X28.7X44.3
PLASTIC BOX WITH 60 RIVETS	6/20	16.7/15.5	34.5X34X43.5



Material: Aluminium PVC Handle Material: Carbon Steel



Suitable for  
2.4-3.2-4.0-4.8mm  
(3/32", 1/8", 5/32", 3/16")  
Aluminum Rivets

**TL4102-1 265mm(10.5")**  
**U.S.A. Style Aluminium Riveter**

Packing	Inner ctn/outer ctn(pc)	G.w/n.w(kg)	Pack measurement(cm)
BLISTER CARD	6/24	14.9/13.7	37X26.5X38

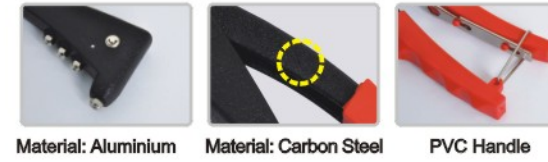

Material: Aluminium Material: Carbon Steel PVC Handle



Suitable for  
2.4-3.2-4.0-4.8mm  
(3/32", 1/8", 5/32", 3/16")  
Aluminum Rivets

**TL4107 260mm(10.5")**  
**ITALY Style Aluminium Riveter**

Packing	Inner ctn/outer ctn(pc)	G.w/n.w(kg)	Pack measurement(cm)
BLISTER CARD	6/24	12.6/11.4	38.5X28.5X38
DOUBLE BLISTER	6/24	13/11.8	39X33.5X40



Material: Aluminium PVC Handle Material: Carbon Steel



Suitable for  
2.4-3.2-4.0-4.8mm  
(3/32", 1/8", 5/32", 3/16")  
Aluminum Rivets

**TL4104 290mm(11.5")**  
**ITALY Style Aluminium Riveter**

Packing	Inner ctn/outer ctn(pc)	G.w/n.w(kg)	Pack measurement(cm)
PLASTIC BAG	0/30	22/21	38.5X34X18.5
BLISTER CARD	12/24	19.8/18.6	40.5X38.5X23
DOUBLE BLISTER	6/24	19.8/18.6	39.5X28X42
COLOR BOX	12/24	19.8/18.6	32.3X23.8X46



Material: Aluminium PVC Handle Material: Carbon Steel



Suitable for  
2.4-3.2-4.0-4.8mm  
(3/32", 1/8", 5/32", 3/16")  
Aluminum Rivets

**TL4102H 265mm(10.5")**  
**Heavy-duty ENGLAND Style Aluminium Riveter**

Packing	Inner ctn/outer ctn(pc)	G.w/n.w(kg)	Pack measurement(cm)
BLISTER CARD	6/24	15/13.8	38.5X28.5X37



Material: Aluminium PVC Handle Material: Carbon Steel



Suitable for  
2.4-3.2-4.0-4.8mm  
(3/32", 1/8", 5/32", 3/16")  
Aluminum Rivets

**TL4105 265mm(10.5")**  
**EUROPEAN & U.S.A. Style Aluminium Riveter**

Packing	Inner ctn/outer ctn(pc)	G.w/n.w(kg)	Pack measurement(cm)
BLISTER CARD	12/24	13.2/12	37X37X23



Material: Aluminium PVC Handle Material: Carbon Steel



Suitable for  
2.4-3.2-4.0-4.8mm  
(3/32", 1/8", 5/32", 3/16")  
Aluminum Rivets

**TL4101 280mm(11")**  
**U.S.A. Style Aluminium Riveter**

Packing	Inner ctn/outer ctn(pc)	G.w/n.w(kg)	Pack measurement(cm)
PLASTIC BAG	0/30	19.6/18.6	36X32.5X18.5
BLISTER CARD	12/24	18/16.8	40.5X38.5X23



Material: Aluminium PVC Handle Material: Carbon Steel



Suitable for  
2.4-3.2-4.0-4.8mm  
(3/32", 1/8", 5/32", 3/16")  
Aluminum Rivets

**TL4109 265mm(11")**  
**EUROPEAN & U.S.A. Style Aluminium Riveter**

Packing	Inner ctn/outer ctn(pc)	G.w/n.w(kg)	Pack measurement(cm)
PLASTIC BAG	0/30	19.8/18.8	42.8X32.3X18.5
DOUBLE BLISTER	12/24	18.6/17.4	46X38X25



PVC Handle

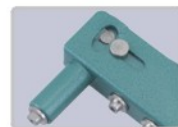

Material: Carbon Steel

Parts List

Part #	Description	QTY.
1	Frame Assembly	1
2	Lever Assembly	1
3	Grip	2
4	Wrench	1
5	Lock	1
6	Return Spring	1
7	Spring Pin	1
8	Pivot Pin	1
9	Pivot Pin Nut	1
10	"S" Clip	2
11	Nose Piece 3/16" Rivet	1
12	Nose Piece 5/32" Rivet	1
13	Nose Piece 1/8" Rivet	1
14	Nose Piece 3/32" Rivet	1
15	Jaw Case	1
16	Jaws	2
17	Jaw Pusher	1
18	Jaw Spring	1
19	Axis Pin	1
20	Nut & Anchor Case	1
21	Nut Mandrel Set 1/4 - 20	1
22	Nut Mandrel Set 10 - 24	1
23	Nut Mandrel Set 8 - 32	1
24	Nut Mandrel Set 6 - 32	1
25	Anchor Mandrel 6 - 32 x 1-1/2"	1
26	Anchor Mandrel 6 - 32 x 2-3/8"	1

**TT4211 250mm(10")**  
**3 IN 1 U.S.A. Style Riveter**

Packing	Inner ctn/outer ctn(pc)	G.w/n.w(kg)	Pack measurement(cm)
DOUBLE BLISTER	6/24	24.2/22.8	46.5X39.5X37.5

**To install Blind Rivets (3/16", 5/32", 1/8" or 3/32"):**

1. Drill proper sized hole for rivet you are using.
2. Select and install correct Nose piece (11,12,13 or 14).Nose pieces have standard right hand thread for installing/removing.
3. Place rivet in the hole and place Nose piece over stem of rivet.
4. Squeeze handle once or twice until stem snaps off rivet.
5. Open handle and turn tool upside down to allow stem to fall out.

**To install Nut Rivets and Rivet Anchors, you must change the Case. Rivet Nuts and Rivet Anchors use the same Case.**

**Changing the Case:**

1. Remove any installed Nose piece by turning it counterclockwise.
2. Hold Pivot Pin (8) against handle to prevent it from turning. Loosen Pivot Pin Nut (9) by turning it clockwise with Wrench (4).
3. Squeeze Lever (2) down and pull it back along Frame (1). This will disengage Lever (2) from Axis Pin (19).
4. Remove Jaw Case (15) from tool.
5. Insert Nut & Anchor Case (20).
6. Push Handle back in place, being sure that Case Pins fit into Handle slots.
7. Push Pivot Pin (8) back in place and retighten it with Wrench (4).

**To install Rivet Nuts (1/4"-20, 10-24, 8-32 or 6-32):**

1. Drill proper sized hole for Rivet Nut to be used.
2. Thread proper Nut Mandrel (21, 22, 23 or 24) onto Nut & Anchor Case (20).
3. Thread Rivet Nut onto Mandrel.
4. Insert Rivet Nut into hole and squeeze handle. This will expand Rivet Nut in hole.
5. Unscrew tool from Rivet Nut.

**To install Anchor Rivets (6-32x1-1/4" or 6-32x2-3/8"):**

1. Drill proper sized hole for Anchor Rivet to be used.
2. Thread proper Anchor Mandrel (25 or 26) onto Nut & Anchor Case (20).
3. Thread Anchor Rivet onto Mandrel.
4. Insert Anchor Rivet into hole and squeeze handle. This will expand Anchor Rivet in hole.
5. Unscrew tool from Anchor Rivet.

Assembly Diagram

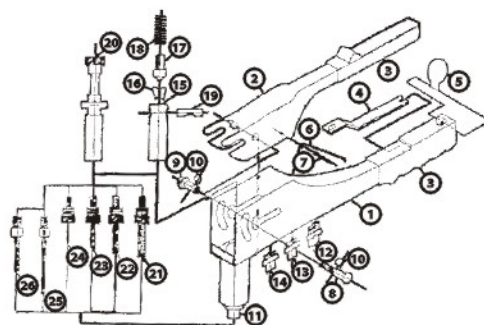

**TIANCHENG TOOLS**



SHAOXING  
TIANCHENG  
TOOL CO.,LTD.  
www.tianchengtools.com



**HAND RIVETER**

The design of new two-color handle is more beautiful, It conforms to the human body engineering mechanics, it is more stable and comfortable when you operate the riveter.



Material: Aluminium



Material: Aluminium



Suitable for  
3.2-4.0-4.8-6.4mm  
(1/8", 5/32", 3/16", 1/4")  
Aluminum Rivets and  
Stainless Rivets

**TD5101H 800mm(32")**  
Heavy-duty U.S.A. Style  
Aluminium Riveter

Packing	Inner ctn/outer ctn(pc)	G.w/n.w(kg)	Pack measurement(cm)
COLOR BOX	0/10	21.3/20.3	33.5X27X41



Material: Aluminium



Material: Aluminium



Suitable for  
3.2-4.0-4.8mm  
(1/8", 5/32", 3/16")  
Aluminum Rivets and  
Stainless Rivets

**TD5105 800mm(32")**  
Heavy-duty ENGLAND Style Riveter

Packing	Inner ctn/outer ctn(pc)	G.w/n.w(kg)	Pack measurement(cm)
COLOR BOX	0/10	22.7/21.7	33.5X27X41



Material:Aluminium



Material:Aluminium



Suitable for  
3.2-4.0-4.8mm  
(1/8", 5/32", 3/16")  
Aluminum Rivets and  
Stainless Rivets

**TD5108 800mm(32")**  
Heavy-duty Riveter

Packing	Inner ctn/outer ctn(pc)	G.w/n.w(kg)	Pack measurement(cm)
COLOR BOX	0/10	22. /21	36X27.5X41



**TB4805 205mm(8")**  
Taiwan Style Gecko Riveter



Material: Carbon Steel



PVC Handle

Packing	Inner ctn/outer ctn(pc)	G.w/n.w(kg)	Pack measurement(cm)
PLASTIC BAG	0/80	23/22.3	38.5X23.3X28.3
BLISTER CARD	12/24	8.6/7.6	40.5X37X23



**TB4803 (5")**  
JAPAN Style Gecko Riveter



Material: Aluminium



PVC Handle

Packing	Inner ctn/outer ctn(pc)	G.w/n.w(kg)	Pack measurement(cm)
PLASTIC BAG	0/40	16.5/15.7	42.5X31X17.5
COLOR BOX	0/30	14/13.3	42X40.7X20.4
BLISTER CARD	0/20	10.5/9.6	46.3X35.5X17
DOUBLE BLISTER	0/20	11/10	47.5X39.5X20



**TSJ4400**  
Ratchet Tap  
M3-M8 M5-M12

	Packing	Inner ctn/outer ctn(pc)	G.w/n.w(kg)	Pack measurement(cm)
M3-M8(85mm)	COLOR BOX	50/100	18.1/17.1	33.5X23.5X14.5
M5-M12(100mm)	COLOR BOX	50/100	30/29	36.5X27.5X16.5
M3-M8(85mm)	BLISTER CARD	12/120	22/21	37.5X21.5X41
M5-M12(100mm)	BLISTER CARD	12/72	22.2/21.2	37.5X22.5X41
M3-M8(250mm)	COLOR BOX	0/50	16/15	27.5X27.5X13
M5-M12(300mm)	COLOR BOX	0/50	26.9/25.9	34X32X16





**TC4601**  
Riveter Adaptor

Packing	Inner ctn/outer ctn(pc)	G.w/n.w(kg)	Pack measurement(cm)
BLISTER CARD	4/32	18.0/15.1	46X32X43



**TC4701**  
Nut Riveter Adaptor

Packing	Inner ctn/outer ctn(pc)	G.w/n.w(kg)	Pack measurement(cm)
BLISTER CARD	4/20	19/16.9	54X30X41



Suitable for  
2.4-3.2-4.0-4.8mm Aluminum Rivets  
2.4-3.2-4.0mm Stainless Rivets

**TC4801** Cordless Riveter

Packing	outer ctn(pc)	G.w (kg)	Pack measurement(cm)
Plastic Box	5	13.5	69.5X34X30



Suitable for  
M3-M4-M5 Rivet Nuts

**TC4901** Cordless Nut Riveter

Packing	outer ctn(pc)	G.w (kg)	Pack measurement(cm)
Plastic Box	5		69.5X34X30



**TC4702**  
Nut Riveter Adaptor

Packing	Inner ctn/outer ctn(pc)	G.w/n.w(kg)	Pack measurement(cm)
BLISTER CARD	4/20	16.3/14.2	54X30X41



## Converting the gun head to achieve three functions

1. Power Cordless Drill



2. Power Cordless Rivet Nut  
Suitable for  
M3-4-5-6-8-10 Nuts



3. Power Cordless Riveter  
Suitable for  
2.4-3.2-4.0-4.8mm  
Aluminium and Stainless Rivets



## 3-IN-1 Cordless Riveter Kit

Packing	outer ctn(pc)	G.w (kg)	Pack measurement(cm)
Plastic Box	4	20.3	48.5X44X32



# Ratchet Wrenches

45# carbon steel body with chromeplate surface and ABS plastic frame.



Material:45# Carbon Steel

**TZB4300**  
**Flat Ratchet Wrenches**

Size	Packing	Inner ctn/outer ctn (set)	G.w/n.w(kg)	Pack measurement(cm)
6-21mm X 5pcs or 1/4"-13/16" X 5pcs	DOUBLE BLISTER PLASTIC SHELF	6/24	23/21.8	33.5X26.5X36
3pc(6-13mm)	DOUBLE BLISTER	10/40	15.5/14.3	31.5X28X35
4pc(9-21mm)	DOUBLE BLISTER	12/24	19/17.8	35.2X29X24
6pc(6-19mm)	STEEL BOX	0/10	15.3/14.3	40.3X25.6X26



Material:45# Carbon Steel

**TZB4303**  
**Flat Ratchet Wrenches With Frame**

Size	Packing	Inner ctn/outer ctn (set)	G.w/n.w(kg)	Pack measurement(cm)
6-21mm X 5pcs or 1/4"-13/16" X 5pcs	DOUBLE BLISTER PLASTIC SHELF	6/24	23.8/22.5	47X33X20
		6/24	23.2/22	38.5X25.3X47



Material:45# Carbon Steel

**TZB4301**  
**25° Ratchet Wrenches**

Size	Packing	Inner ctn/outer ctn (set)	G.w/n.w(kg)	Pack measurement(cm)
6-21mm X 5pcs or 1/4"-13/16" X 5pcs	DOUBLE BLISTER PLASTIC SHELF	6/24	22.4/21.2	45.5X32X27
		6/24	22.3/21.2	38.5X25.3X43
3pc(8-15mm)	HALF DOUBLE BLISTER	10/40	19.3/18	46.5X35.5X24



Material:45# Carbon Steel

**TZB4302**  
**25° Ratchet Wrenches With Frame**

Size	Packing	Inner ctn/outer ctn (set)	G.w/n.w(kg)	Pack measurement(cm)
6-21mm X 5pcs or 1/4"-13/16" X 5pcs	DOUBLE BLISTER PLASTIC SHELF	6/24	23.7/22.4	45.5X32X27.5
		6/24	23.4/22.2	38.5X25.3X47
3pc(6-13mm)	DOUBLE BLISTER	0/20	8.1/7.3	45.3X29.5X14.5
3pc(10-17mm)	HALF DOUBLE BLISTER	10/40	21.8/20.4	50X35.5X25
4pc(6-17mm)	DOUBLE BLISTER	6/24	16.2/15	40.5X30X28



Material:45# Carbon Steel

**THB4310**  
**Flat 4 in 1 Ratchet Wrenches**

Size	Packing	Inner ctn/outer ctn (set)	G.w/n.w(kg)	Pack measurement(cm)
1/4" -5/16" or 6*8/ 3/8" -7/16" or 10*12	BLISTER CARD	30/120	13/12	30X23.5X29.2
3/8" -7/16" or 10*12/ 1/2" -9/16" or 13*14	BLISTER CARD	30/120	19/18	33X25.5X30
13x14/17x19				
15x17/19x21				



**THB4308**  
**4 in 1 Ratchet Wrenches With Frame**

Size	Packing	Inner ctn/outer ctn (set)	G.w/n.w(kg)	Pack measurement(cm)
6-19mmx3pcs	BLISTER CARD	6/36	20.6/19.4	48.5X34X23



Double Blister



Double Blister



Double Blister



Double Blister



Black Plastic Card



Half Double Blister



Double Blister



Double Blister



Plastic Shelf



Double Blister



Blister Card



Blister Card



Blister Card



Plastic Box With Rivets



Blow Case



Blow Case



Blow Case



Plastic Box With Rivets



Double Blister



Double Blister



Blister Card



Double Blister



Double Blister



Double Blister



Double Blister



Blister Card With Rivets



Double Blister

