



Kleine
Wolke®



CLASSIC COLLECTION 2024



Willkommen

Welcome

Bienvenue

bei Kleine Wolke



Design team und Produktentwicklung arbeiten Hand in Hand

Vom Tau zum Traumbad

Hervorgegangen aus der 1793 in Bremen gegründeten Bremer Tauwerkfabrik ist Kleine Wolke seit 1968 Synonym für hochwertige Badtextilien. Zum Sortiment von Kleine Wolke gehören heute neben Badteppichen auch Duschvorhänge, Sicherheitseinlagen für Duschen und Badewannen, Seifenspender, Kosmetikeimer, WC-Sitze und Accessoires – mit einem Wort: alles, was das Bad schön und praktisch macht.

From rope to dream bathroom

Emerging from Bremer Tauwerk-Fabrik founded in Bremen in 1793, Kleine Wolke has been synonymous with high-quality bathroom textiles since 1968. The Kleine Wolke product range now not only includes bathroom rugs, but also shower curtains, non-slip mats for showers and bathtubs, soap dispensers, cosmetic bins, toilet seats and accessories – in a nutshell: everything you need to make the bathroom beautiful and practical.

Des cordages à la salle de bain idéale

Issue d'une usine de cordages fondée à Brême en 1793, Kleine Wolke est synonyme de textiles haut de gamme pour la salle de bain depuis 1968. Outre des tapis de bain, l'assortiment de Kleine Wolke comprend désormais des rideaux de douche, des tapis antidérapants pour la douche et la baignoire, des distributeurs de savon, des poubelles à cosmétiques, des lunettes de toilettes et des accessoires. En un mot : tout ce qui embellit la salle de bain et la rend plus fonctionnelle.



Alles aus einer Designwelt

Schon früh haben wir den Wunsch vieler Endverbraucher nach einem möglichst einheitlichen Design quer durch alle Bestandteile der Badausstattung erkannt. Unser Designteam und die Produktentwicklung in Bremen arbeiten deshalb Hand in Hand und fassen große Teile unseres Sortiments in Designwelten zusammen. Kunden können so ihr ganzes Bad und auch angrenzende Wohnräume mit ihren Lieblingsfarben oder -motiven ausstatten.

Everything from one design world

We recognised early on the desire of many customers for a design that provides a uniform impression across all elements of bathroom furnishings. Our design team and product development in Bremen therefore work hand in hand and compile the majority of our product range as design worlds. This allows customers to decorate their bathroom and even adjacent spaces in their favourite colours or designs.

Des articles d'un même univers thématique

Très tôt, nous avons souhaité répondre aux souhaits de nombreux clients avec un design le plus cohérent possible appliqué à tous les éléments de la salle de bain. Notre équipe de conception et le développement produit situés à Brême coopèrent étroitement et combinent de nombreux articles de notre assortiment au sein d'univers thématiques. Aussi, nos clients peuvent équiper leur salle de bain et les pièces voisines en optant pour leurs couleurs et motifs préférés.

Der Umwelt zuliebe

In Zusammenarbeit mit Verpackungsexperten haben wir plastikfreie Alternativen für die Verpackungen unserer Produkte entwickelt. In Einzelfällen, in denen nicht auf den Einsatz von Plastik verzichtet werden kann, verwenden wir künftig ausschließlich recyceltes Material. So können wir jährlich ca. 60 Tonnen Plastikmüll einsparen und einen Beitrag zum Umweltschutz leisten.

For the good of the environment

In collaboration with packaging experts, we have developed alternatives for our product packaging free from plastic. In isolated cases where plastic cannot be completely avoided, we will only be using recycled material in the future. This allows us to save about 60 tonnes of plastic waste per year and make our contribution to environmental protection.

Par respect de l'environnement

En relation étroite avec des spécialistes des emballages, nous avons mis au point pour nos produits des emballages alternatifs, sans plastiques. Lorsqu'il n'est pas possible de renoncer entièrement à l'utilisation de plastique, nous utilisons exclusivement des matériaux recyclés. Cela nous permet d'économiser 60 tonnes de déchets plastiques chaque année et de contribuer ainsi à la protection de l'environnement.



Inhalt

Content
Contenu

WILLKOMMEN BEI KLEINE WOLKE Welcome to Kleine Wolke Bienvenue chez Kleine Wolke	1	WC-SITZE WC seats Abattants WC	200-203
DESIGNWELTEN Worlds of design Les mondes design	4-9	DUSCHVORHÄNGE Shower curtains Rideaux de douche	204-233
BADTEPPICHE / FROTTIER / HOLZMATTEN Bath rugs / terry cloth / wooden mats Tapis de bain / tissu-éponge / tapis en bois	10-103	ZUBEHÖR + DUSCHROLLOS Fittings / Shower blind Garniture / Store de douche	234-243
CREATIVO DESIGN CREATIVO DESIGN CREATIVO DESIGN	104-129	SICHERHEITSEINLAGEN + DEKORE Safety inserts / Deco-Accessories Tapis anti-dérapants / Deco-Accessoires	244-257
ACCESSOIRES Accessories Accessoires	130-167	EINSTIEGSPREISLAGEN Entry price levels Catégories de prix de départ	258-263
BADORGANISATION Bathroom organisation Organisation pour la salle de bain	168-189	POS-VERMARKTUNGSKONZEPT Marketing concepts Concepts de commercialisations	264-275
KOSMETIKSPIEGEL Cosmetic mirror Miroir de maquillage	190-199	SERVICE-VERTRIEB Service sales Service de distribution	276-278

DESIGNWELT

Einfach Meer



Am Meer zu sein ist eines der schönsten Gefühle der Welt. Die Designwelt „Einfach Meer“ steht für Natur, frische Luft und Weite - einfach mal die Seele baumeln lassen. Der gemütliche Minimalismus schafft Ruhe und Leichtigkeit, die sich auch in den natürlichen Farben Taupe, Beige, Stahlblau und Mare widerspiegelt. Abgerundete, fließende Formen vermitteln ein gutes Gefühl. So können wir den Alltag loslassen und MEHR MEER in einem schönen Badezimmer genießen!



Being near the sea is one of the most wonderful feelings in the world. The "Simply Ocean" design range is associated with nature, fresh air and the open ocean – just let your mind wander. The homely minimalism creates a sense of calm and lightness, which is also reflected in the natural colours of taupe, beige, steel blue and mare. Rounded, flowing shapes convey a sense of positivity. This enables us to let go of the daily grind and enjoy the OPEN OCEAN in a beautiful bathroom!

Être en mer est l'une des plus belles sensations au monde. Le monde du design « Mer authentique » symbolise la nature, l'air frais et le large - et permet de laisser les pensées vagabonder. Un minimalisme cosy invite au calme et à la légèreté, ce qui se reflète également par l'utilisation de teintes naturelles comme le taupe, le beige, le bleu acier et le bleu mare. Des formes douces et fluides apaisent les sensations. Déconnectez-vous du quotidien et profitez ENCORE PLUS DE L'OcéAN dans une belle salle de bains !

1. **BATH RUG ZIGZAG**, 738 Hellblau, Seite 92 2. **BATH RUG TERRACE**, 226 Sandbeige, Seite 78 3. **TERRY TOWEL BAO**, 783 Mare und 114 Schneeweiß, Seite 100 4. **ACCESSORIESE DASH**, 754 Iceblue, Seite 144 5. **BATH RUG PIANA**, 226 Sandbeige, Seite 67 6. **ACCESSORIESE SARDINAS**, 783 Mare, Seite 162 7. **SHOWER CURTAIN SARDINAS**, 148 Multicolor, Seite 221



DESIGNWELT

Neue Ernte



Grün steht für Erneuerung und Wachstum. Kein Wunder, dass Grün in allerlei Varianten aus dem Interieur-Bereich nicht mehr wegzudenken ist. Trendhighlight in diesem Jahr sind satte, Olivttöne gemischt mit Beige und Braun. Rustikale Haptiken und Texturen sowie ein Hauch von Unvollkommenheit zeichnen die Designwelt aus. Genau richtig für alle Naturliebhaber, die Ihr Lebensgefühl auch im Badezimmer wiederfinden möchten.



Green symbolises renewal and growth. It is no wonder, then, that green in all its forms has become an indispensable element of interior design. This year's main trend is for rich olive tones mixed with beige and brown. Rustic haptics and textures as well as a touch of imperfection are what define this design world. Ideal for every nature lover who wants to reflect their attitude to life in their bathroom too.

Le vert est la couleur du renouveau et de la croissance. Rien d'étonnant à retrouver le vert sous toutes ses déclinaisons dans les espaces intérieurs. Cette année, la tendance est aux teintes olive satinées, assorties au beige et au marron. Le toucher et les textures rustiques ainsi qu'une touche d'imperfection caractérisent

1. BATH RUG GLOW, 616 Dill, Seite 44 2. BATH RUG MARCO, 612 Forest, Seite 54 3. COSMETIC BINS GLOSSY, 616 Dill, Seite 171
4. TERRY TOWEL BAO, 655 Linde, Seite 100 5. ACCESSORIESEE MADERA, 318 Braun, Seite 152 6. ACCESSORIESEE DASH TRAY, 202 Natur, Seite 174 7. BATH RUG CORD, 616 Dill, Seite 31 8. ACCESSORIESEE BRACE, 612 Forest, Seite 140 9. SHOWER CURTAIN SELVA, 616 Dill, Seite 221



DESIGNWELT *Daydream*



Let's dream a little dream...

Warme Flieder- und Lilatöne kombiniert mit ausgewähltem Beige und harmonischen Abstufungen von Grau. Diese Designwelt spricht unsere empathische, spirituelle Seite an. Gekonnt spielt die weiche, abgerundete, teils blumige Formsprache mit glatten, glänzenden oder milchigen Oberflächen. Das Gesamtbild wirkt edel und elegant. Lassen wir uns zu einem kleinen Tagtraum in unserer persönlichen Wohlfühloase verleiten...



Let's dream a little dream...

Warm lilac and purple tones combine with carefully selected beige and harmonious gradations of grey. This design world appeals to our empathetic, spiritual side.

The soft, rounded, sometimes flowery design plays cleverly with smooth, shiny or opaque surfaces.

The overall appearance is classy and elegant. Let's indulge in a little daydream in our own personal oasis of well-being...

Rêvons un peu...

Des teintes de lilas et de violet associées à un beige précis et à d'harmonieuses déclinaisons de gris. Cet univers du design parle à notre côté empathique et spirituel.

La douceur du langage visuel, arrondi et partiellement fleuri, joue habilement avec les surfaces lisses, brillantes ou laiteuses. Le résultat final est à la fois raffiné et élégant. Laissons-nous aller à un peu de rêverie dans notre oasis de bien-être personnelle...

1. BATH RUG DREAM, 158 Auster, Seite 38 **2. BATH RUG GLOW**, 851 Lavendel, Seite 44 **3. BATHROOM ORGANISATION ASPERA**, 851 Lavendel und 852 Erika, Seite 172 **4. TERRY TOWEL BAO**, 851 Lavendel, Seite 100 **5. WC SEATS DAHLIA**, 851 Lavendel, Seite 201 **6. COSMETIC BINS SILENCE**, 851 Lavendel, Seite 171 **7. ACCESSORIESE OPALIS**, 213 Perlmutter, Seite 157 **8. SHOWER CURTAIN TEMPTATION**, 851 Lavendel, Seite 223



Badteppiche

Frottierwaren und Holzmatten

*Bath rugs, terry cloth and wooden mats
tapis de bain, tissu-éponge et tapis en bois*

Qualitätsmerkmale für Badteppiche, Frottierwaren und Holzmatten

Quality features for bath rugs, terry cloth and wooden mats
Caractéristiques de qualité pour tapis de bain, tissu-éponge et tapis en bois

- **Synthetik-Materialien:** pflegeleicht, schnelltrocknend, abriebfest
 - **Natur-Materialien:** Naturprodukt, hohe Wasseraufnahme, hautverträglich
 - hochwertige Florgarne, ausgewählte Trägermaterialien, haltbare Rückenbeschichtungen
 - strenge Qualitätskontrolle für Garne, Farbchheiten und Alterungsbeständigkeit der Beschichtungen
 - eine Vielzahl der Badteppiche sind mit einer hochwertigen, rutschhemmenden TPE-Beschichtung ausgestattet
 - umweltfreundlich und schadstofffrei
- **Synthetic materials:** easy to clean, fast drying, abrasion-resistant
 - **Natural materials:** natural product, high water absorption, does not cause skin irritation
 - high-quality weft thread, select base materials, durable back coatings
 - strict quality controls for threads, colour fastness and durability of the coatings
 - a wide range of bathroom rugs are fitted with a high-quality, slip-resistant TPE coating
 - environmentally friendly and pollutant-free
- **Matériaux synthétiques:** faciles à entretenir, séchage rapide, antiabrasifs
 - **Matériaux naturels:** produits naturels, très haute capacité d'absorption, agréables au toucher
 - étoffe filée de haute qualité, matériaux de support soigneusement sélectionnés, revêtement longue durée sur l'endos
 - contrôle strict de la qualité des fils résistance des couleurs et du revêtement anti-dérapant
 - un grand éventail de tapis de bain, équipés d'un revêtement antidérapant en TPE de qualité supérieure
 - écologique et exempt de substances nocives





RELAX 14/15



ALHAMBRA 16



AMALIA 17



ARIZONA 18



AYANA 19



BEACH 20



BERLIN 21



BOHO 22

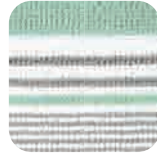

BOLA 23



BOW 24



CARACAS 25



CARO 26



CELINE 27



CHRISSE 28



COMO 29



CONY 30



CORD 31



CORY 32



CROSS 33



CUBETTO 34



DAHLIA 35



DAKOTA 36



DOTS 39



DREAM 38



FIESTA 39



FIONA 40



FLAME 41



FLORES 42



GEORGE 43



GLOW 44



HAVANNA 45



HELENA 46



KANSAS 47



KARA 48



LEAF 49



LIFE 50



LOOP 51



LOUNGE 52



MALIN 53



MARCO 54



MEADOW 55

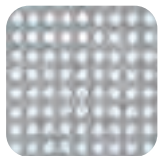

MERIDA 56



MIAMI 57



MINA 58



MIX 59



MONROVIA 60

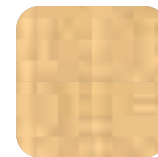

MOSAIC 61



NET 62



NEW YORK 63



NEVOA 64



OSLO 65



PHOENIX 66



PIANA 67



PUNTO 68

SEITE 69-95

Badteppiche / bath rugs / tapis de bain



RIVA 69



RUMBA 70



SAVANNAH 71



SEATTLE 72



SELVA 73



SEAWOLRD 74



SPLASH 75



SWAY 76



TENDER 77



TERRACE 78

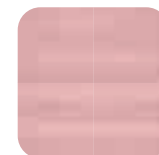

TIKKA 79



TILES 80



TRAVIS 81



TRAM 82



TREND 83



VAGA 84



VANESSA 85



VITA 86



WAVE 87



WILLOW 88



WILNA 89



YARA 90



ZAGREB 91



ZIGZAG 92

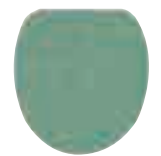

SOFT DECKEL 93



ANTI-RUTSCH 93



MORNING 94



SURF 95

SEITE 96 -103

Frottier+ Holzmatten / Terry cloth + Wooden mats / Eponge + Tapis en bois



LODGE 96

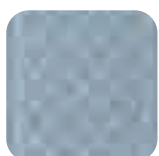

BRIDGE 97



STRADA 97



BAO 98



LEAF 99



SAVANNAH 99



ROYAL 100



VIA 101



BAMBUS 102

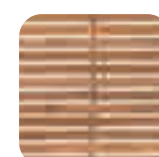

LEVEL 102

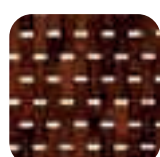

PALITO 103



KOLLEKTION AUS NACHWACHSENDEN ROHSTOFFEN

In der heutigen Zeit sind Nachhaltigkeit und Umweltbewusstsein zentrales Thema unserer Gesellschaft. Mit unserem **ECO-LIVING-Sortiment** erfüllen wir alle Anforderungen einer umweltbewussten Kollektion aus nachwachsenden Rohstoffen. Gesundheitsverträgliche Rohstoffe und biologisch abbaubare Fasern werden zu nachhaltigen Produkten gefertigt.

COLLECTION MADE FROM SUSTAINABLE MATERIALS

Sustainability and environmental awareness are central themes in today's society. With our **ECO-LIVING** product range from Kleine Wolke we are able to meet all the requirements of an environmentally conscious collection produced from renewable raw materials. We transform health-friendly raw materials and biodegradable fibres into sustainable products.

UNE COLLECTION EN MATIÈRES RENOUVELABLES

Aujourd'hui, la durabilité et la conscience écologique occupent une place centrale dans notre société. Avec notre assortiment **ECO-LIVING** Kleine Wolke, nous répondons à toutes les exigences requises pour une collection écologique en matières renouvelables. Pour fabriquer nos produits durables, nous utilisons des fibres biodégradables ainsi que des matières premières respectueuses de la santé.



KOLLEKTION AUS RECYCELTEN MATERIALIEN

Unsere **ECO-CARE** Collection wird aus recycelten Materialien hergestellt. Materialien wie Baumwolle, PET-Flaschen oder Glas werden recycelt und zu neuen Produkten verarbeitet. Durch den geringen Energieverbrauch bei der Produktion und dem Transport lassen sich erhebliche CO₂-Emissionen einsparen. Kleine Wolke trägt damit zum Klimaschutz bei. Durch nachhaltiges Recycling sehen wir uns in der Verantwortung Ressourcen nachhaltig zu nutzen, Energie einzusparen und die Umwelt zu schonen.

COLLECTION MADE FROM RECYCLED MATERIALS

Our **ECO-CARE** Collection is made using recycled materials. Materials such as cotton, PET bottles and glass are recycled and turned into new products. The low energy consumption during production and transport allow for considerable reductions in CO₂ emissions. This is one way in which Kleine Wolke contributes to climate protection. This sustainable recycling programme enables us to take responsibility for using resources sustainably, conserving energy and protecting the environment.

UNE COLLECTION EN MATIÈRES RECYCLÉES

Notre collection **ECO-CARE** est produite à partir de matériaux recyclés. Des matériaux comme le coton, les bouteilles en PET ou le verre sont recyclés et transformés en nouveaux produits. Grâce à leur faible consommation énergétique durant leur production et leur transport, ces matières ne génèrent aucune émission de CO₂ élevée. Kleine Wolke contribue ainsi à lutter contre le réchauffement climatique. En appliquant un processus de recyclage durable, nous avons la responsabilité d'utiliser durablement des ressources, d'économiser de l'énergie et de préserver l'environnement.

Wunderschön und zeitlos elegant

Das Badteppich-Modell **RELAX** überzeugt im Besonderen durch seine außergewöhnliche Melange-Optik und seinen hohen Flor. Eine große Auswahl an möglichen Melange-Farben* stehen zur Verfügung. Das Uni-Programm bietet neben vielen Größen und Formen auch Badteppiche in individueller Wunschmaß-Fertigung.

* 115 Polarweiß und 926 Schwarz sind nicht meliert.

The RELAX model is particularly appreciated by customers thanks to its unusual blended look. A wide range of possible melange colours* is available. In addition to many sizes and shapes, the plain programme also offers bathroom carpets in individual custom-made designs.

* 115 polar white and 926 black are not mottled.

Le modèle RELAX se distingue grâce à son apparence chinée si exceptionnelle. Un grand choix de couleurs de mélange possibles* est disponibles. En plus de nombreuses tailles et formes, le programme simple propose également des tapis de salle de bains au design personnalisé.

* 115 Polarweiß und 926 Schwarz: non chiné.



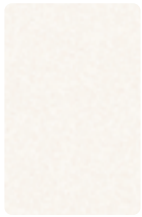

115*
Polarweiß
*Nicht meliert
*Not mottled
*Non chiné



189
Grau



220
Champagner



226
Sandbeige



271
Taupe



316
Rost



453
Rubin



553
Mimose

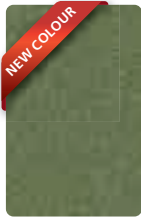

612
Forest



615
Kiwigrün



663
Pazifik



672
Türkis



685
Maledivia



723
Azur



736
Atlantikblau



901
Anthrazit



926*
Schwarz
*Nicht meliert
*Not mottled
*Non chiné



Mit rutschhemmender
TPE-Beschichtung

Equipped with an anti-slip TPE-coating
Avec revêtement TPE antidérapant



5405 ... 104
ca. 47 x 50 cm



5405 ... 129
ca. 55 x 55 cm



5405 ... 521
ca. 100 cm rund

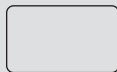

5405 ... 539
ca. 55 x 65 cm

5405 ... 207
ca. 50 x 80 cm

5405 ... 360
ca. 60 x 100 cm

5405 ... 225
ca. 70 x 120 cm

5405 ... 453
ca. 85 x 150 cm

100% Polyacryl



Florhöhe (mm)
Pile height
Hauteur mèches

30

Deckelbezug (mm)
Lid cover
Housse

20



Weitere Formen und Wunsch-
maße finden Sie im CREATIVO
Teil Seite 112-113.

You can find other shapes and custom
dimensions in the CREATIVO section,
pages 112-113.

Retrouvez d'autres formes et dimensi-
ons souhaitées dans la section CREA-
TIVO, aux pages 112-113.

ALHAMBRA



Micro-Polyester für besonders weiche Oberfläche
Hergestellt mit recyceltem Polyester
Mit rutschhemmender Rückenbeschichtung

Micro-polyester for a super soft surface
Made with recycled polyester
Equipped with an anti-slip TPE-coating

Du micropolyester pour une surface particulièrement douce
Fabrication avec du polyester recyclé
Avec revêtement antidérapant



685
Maledivia

100% Polyester



Florhöhe (mm)
Pile height
Hauteur mèches

15



9174 ... 135
ca. 60 x 60 cm



9174 ... 360
ca. 60 x 100 cm



9174 ... 225
ca. 70 x 120 cm

Das passt dazu:
That fits: / Ça correspond:

ALHAMBRA
Textiler Duschvorhang im passenden Design
Textile shower curtain in matching design
Rideau de douche en textile au design ass
> Seite 207 / page 207





Fein gestreifter
Badteppich aus
100 % Cotton
Mit rutschhemmender
Rückenbeschichtung

Bathroom rug with micro-stri-
pes made from 100% cotton
Equipped with an anti-slip
TPE-coating

Un tapis de bain à fines
rayures, 100 % coton
Avec revêtement TPE
antidérapant



202
Natur



271
Taupe

100% Cotton



Florhöhe (mm)
Pile height
Hauteur mèches



9152 ... 433
ca. 50 x 60 cm



9152 ... 519
ca. 60 x 90 cm



9152 ... 225
ca. 70 x 120 cm

ARIZONA



Überzeugend schlichtes
Design
Klassische Farbigkeit
Doubleface-Optik

Convincingly simple design
Classic colours
Reversible design

Design simple et efficace
Coloris classiques
Aspect double face

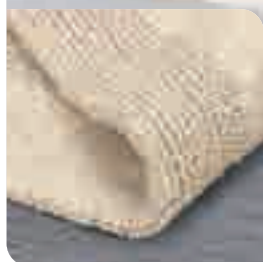

146
Silbergrau



202
Natur

100% Cotton



Florhöhe (mm)
Pile height
Hauteur mèches

8	10
10	8



5477 ... 539
ca. 55 x 65 cm

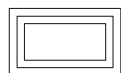

5477 ... 360
ca. 60 x 100 cm

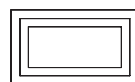

5477 ... 225
ca. 70 x 120 cm

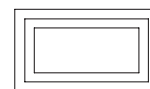

5477 ... 657
ca. 80 x 140 cm



Mit rutschhemmender TPE-Beschichtung

Equipped with an anti-slip TPE-coating

Avec revêtement TPE anti-dérapant



289
Seide
*114 Schneeweiß



685
Maledivia
*685 Maledivia



783
Mare
*754 Iceblue



926
Schwarz
*226 Sandbeige

100% Polyacryl



Florhöhe (mm)

Pile height
Hauteur mèches



Deckelbezug (mm)

Lid cover
Housse



8888 ...104*
ca. 47 x 50 cm



9149 ... 130
ca. 55 x 50 cm



9149 ... 539
ca. 55 x 65 cm



9149 ... 360
ca. 60 x 100 cm

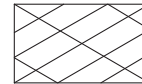

9149 ... 225
ca. 70 x 120 cm

BEACH



Mit rutschhemmender TPE-Beschichtung

Equipped with an anti-slip TPE-coating

Avec revêtement TPE antidérapant

2-farbige Motive mit Hoch-Tiefeffekt

2-colored motifs with high-low effect

Motifs bicolores avec effet haut-bas



158
Auster
* 114 Schneeweiß



316
Rost
* 316 Rost



723
Azur
* 769 Marineblau

100% Polyacryl



Florhöhe (mm)
Pile height
Hauteur mèches



Deckelbezug (mm)
Lid cover
Housse



8888 ... 104*
ca. 47 x 50 cm



4581 ... 150
ca. 50 x 50 cm



4581 ... 357
ca. 55 x 65 cm



4581 ... 360
ca. 60 x 100 cm

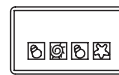

4581 ... 225
ca. 70 x 120 cm



Sehr weiche Oberfläche und filigraner Digitaldruck mit City Map
Mit rutschhemmender Beschichtung

Super soft surface and filigree digital print with City Map
Equipped with an anti-slip coating

Une surface très souple et une impression digitale filigrane avec City Map
Avec revêtement antidérapant



146
Silbergrau

100% Polyester



Florhöhe (mm)
Pile height
Hauteur mèches

8



5539 ... 207
ca. 50 x 80 cm

BOHO



Lässig natürliche Optik
Besonders hoher Flor
Mit recycelter
Baumwolle
Mit rutschhemmender
Beschichtung

Bath rug in rustic look
With recycled cotton
Equipped with an anti-slip
coating

Tapis de bain en aspect
rustique
Avec du coton recyclé
Avec revêtement antidérapant



202
Natur

100% Cotton



Florhöhe (mm)
Pile height
Hauteur mèches

36



9157 ... 539
ca. 55 x 65 cm



9157 ... 360
ca. 60 x 100 cm



9157 ... 225
ca. 70 x 120 cm

Das passt dazu:

That fits: / Ça correspond:

SLACK
Drahtkorb, ideal
für Gästehandtücher

Wire basket, ideal for guest towels
R Corbeille en fil métallique, idéale pour les
serviettes d'invités

> Seite 176 / page 176





Chenilleschlaufen mit
weichem Flor
Mit rutschhemmender
Beschichtung

Equipped with an anti-slip
coating

Avec revêtement
antidérapant



685
Maledivia



783
Mare



901
Anthrazit

100% Polyester



Florhöhe (mm)
Pile height
Hauteur mèches

18



9143 ... 539
ca. 55 x 65 cm

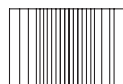

9143 ... 519
ca. 60 x 90 cm

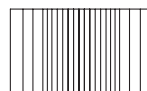

9143 ... 225
ca. 70 x 120 cm

BOW



Mit rutschhemmender TPE-Beschichtung

Equipped with an anti-slip TPE-coating

Avec revêtement TPE anti-dérapant



226
Sandbeige



926
Schwarz

100% Polyacryl



Florhöhe (mm)
Pile height
Hauteur mèches



9172 ... 539
ca. 55 x 65 cm

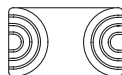

9172 ... 360
ca. 60 x 100 cm

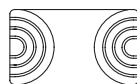

9172 ... 225
ca. 70 x 120 cm

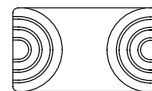

9172 ... 657
ca. 80 x 140 cm

Das passt dazu:
That fits: / Ça correspond:

FELLONE
> Seite 174 / page 174





Weicher Baumwoll/
Viskose-Teppich in
angesagter
Vintageoptik
Mit rutschhemmender
Beschichtung

Stylish soft cotton/viscose
vintage-style rug
Equipped with an anti-slip
coating



146
Silbergrau

78% Cotton / 22% Viskose



Florhöhe (mm)
Pile height
Hauteur mèches

10



4065 ... 135
ca. 60 x 60 cm

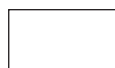

4065 ... 360
ca. 60 x 100 cm



4065 ... 225
ca. 70 x 120 cm

CARO



Mit rutschhemmender
TPE-Beschichtung

Equipped with an anti-slip
TPE-coating

Avec revêtement TPE anti-
dérapant



179
Flanell
*901 Anthrazit



287
Kaschmir
*114 Schneeweiß



304
Terracotta
*415 Koralle



407
Old Rose
*436 Beere



414
Salmon
*114 Schneeweiß



617
Distel
*114 Schneeweiß



675
Petrol
*675 Petrol



783
Mare
*754 Iceblue



926
Schwarz
*226 Sandbeige

100% Polyacryl

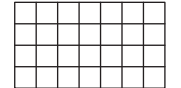
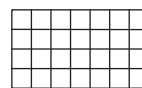

Florhöhe (mm)
Pile height
Hauteur mèches

Deckelbezug (mm)
Lid cover
Housse

8888 ... 104*
ca. 47 x 50 cm

5426 ... 129
ca. 55 x 55 cm

5426 ... 539
ca. 55 x 65 cm

5426 ... 382
ca. 60 x 105 cm

5426 ... 225
ca. 70 x 120 cm

5426 ... 453
ca. 85 x 150 cm



Uni-Teppich aus groben Schlingen mit weicher Haptik

Mit rutschhemmender Beschichtung

Uni carpet made of coarse loops with a soft feel Equipped with an anti-slip coating

Tapis Uni boucles grossières avec un toucher doux Equipped with an anti-slip coating



291 Bast

70% Polyester / 30% Cotton



Florhöhe (mm)
Pile height
Hauteur mèches

32



9120 ... 135
ca. 60 x 60 cm



9120 ... 360
ca. 60 x 100 cm

CHRISSEY

Wendeteppich aus 100% recycelter Cotton.
Eine Seite mit geschnittenem Flor, die andere Seite mit Schlingen gefertigt. Wiederverwendung wertvoller Rohstoffe Umweltschonendes, mechanisches Recyclingverfahren ohne den Einsatz von chemischen Stoffen Hautsympathisch und strapazierfähig

Reversible carpet made of 100% recycled cotton. One side with cut pile the other side with slings made. Reuse of valuable raw materials Environmentally friendly, mechanical recycling process without the use of chemical substances Skin-friendly and very hardwearing

Tapis réversible en coton 100% recyclé. Un côté avec une pile coupée, l'autre côté avec les frondes sont faites. Réutilisation de ressources précieuses Processus de recyclage mécanique et écologique sans l'utilisation de substances chimiques Agréable au toucher et ultra durable



100
Weiß



146
Silbergrau



202
Natur

Das passt dazu:
That fits: / Ça correspond:

PATCH
Flexible Körbe zur Aufbewahrung von Badaccessoires

Flexible baskets for storage of bathroom accessories
Paniers flexibles pour stockage d'accessoires de salle de bain

> Seite 175 / page 175



100% Cotton



Florhöhe (mm)
Pile height
Hauteur mèches

12
12



9146 ... 539
ca. 55 x 65 cm



9146 ... 360
ca. 60 x 100 cm



9146 ... 427
ca. 65 x 115 cm

NEW COLOUR



Hochwertiger Webteppich in modischem Marmor-Design
Mit rutschhemmender Beschichtung

High-quality cotton woven rug in a stylish marble design
Equipped with an anti-slip coating

Tapis tissé de qualité en coton dans un design marbre moderne
Avec revêtement antidérapant

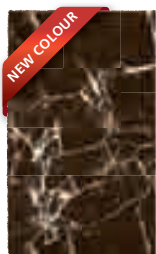

301
Nussbraun



977
Platin

Das passt dazu:
That fits: / Ça correspond:

MARBLE
Textiler Duschvorhang in Marmor-Optik
Shower curtain in matching design
Rideau de douche au design assorti
> Seite 218 / page 218



100% Cotton



Florhöhe (mm)
Pile height
Hauteur mèches

16



4073 ... 135
ca. 60 x 60 cm



4073 ... 360
ca. 60 x 100 cm



4073 ... 225
ca. 70 x 120 cm



Super weicher
Badteppich in Felloptik
Mit rutschhemmender
TPE-Beschichtung

Super soft Bath rug in fur
look
Equipped with an anti-slip
TPE-coating

Tapis de bain super doux à
l'aspect fourrure
Avec revêtement TPE anti-
dérapant



146
Silbergrau



201
Beige



352
Kastanie



783
Mare



926
Schwarz

100% Polyester



9139 ... 539
ca. 55 x 65 cm



9139 ... 360
ca. 60 x 100 cm



9139 ... 225
ca. 70 x 120 cm

Florhöhe (mm)
Pile height
Hauteur mèches

25



Streifendesign durch starken Hoch-Tief-Effekt
Mit rutschhemmender TPE-Beschichtung

Stripe design through strong high-low effect
Design à rayures grâce à un fort effet haut/bas

Equipped with an anti-slip TPE-coating
Avec revêtement TPE antidérapant



226 Sandbeige

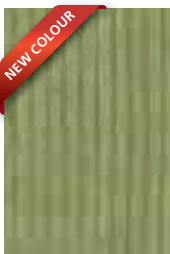

616 Dill



746 Stahlblau

DESIGNWELT
NEUE ERNTE



Das passt dazu:
That fits: / Ça correspond:

RUNA
Accessoire-Serie mit Rillenstruktur

Accessory series with groove structure
Série d'accessoires avec structure à rainures

> Seite 160 / page 160



100% Polyacryl



Florhöhe (mm)
Pile height
Hauteur mèches



9170 ... 135
ca. 60 x 60 cm

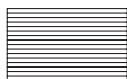

9170 ... 360
ca. 60 x 100 cm

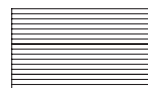

9170 ... 225
ca. 70 x 120 cm

CORY

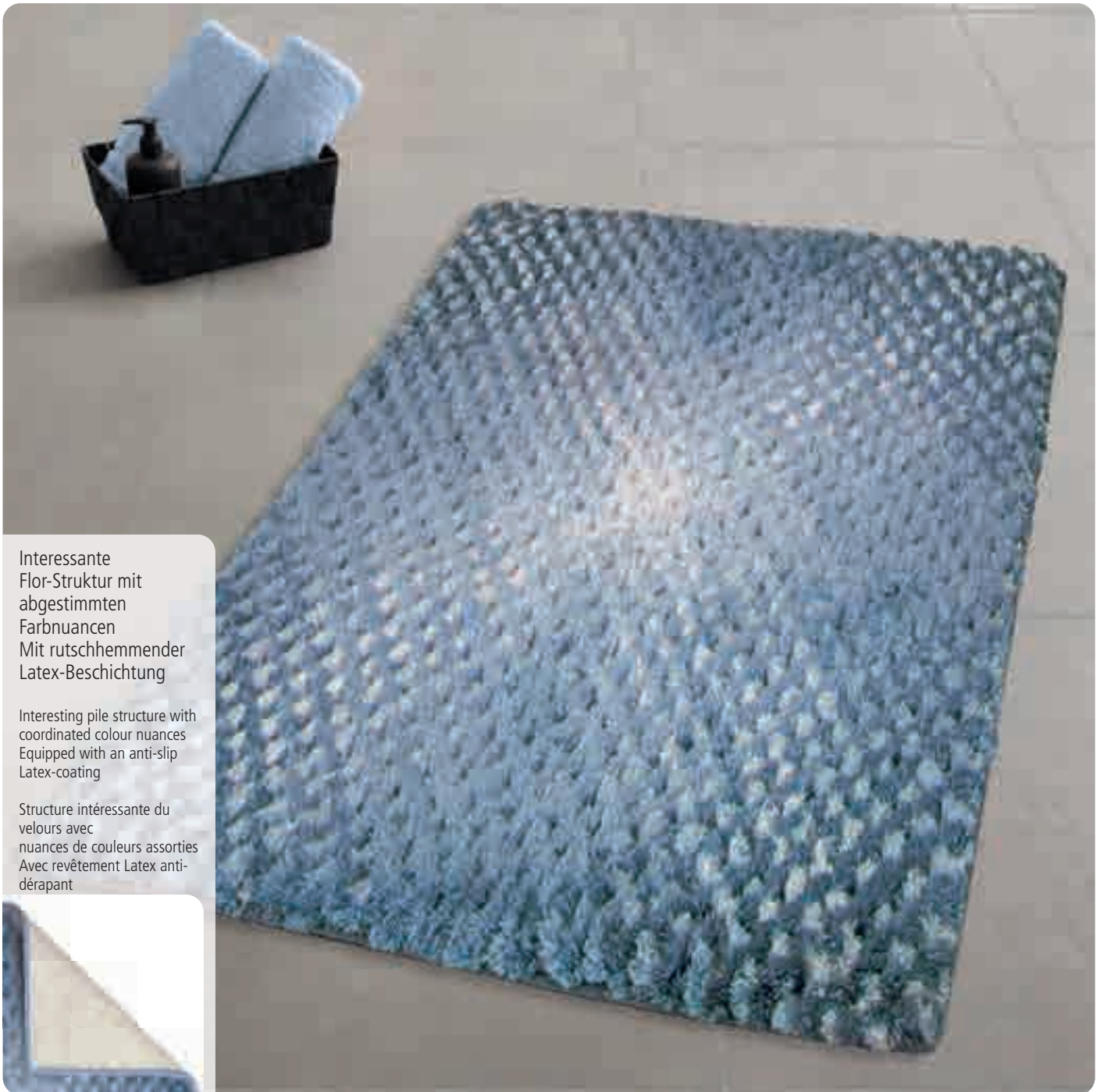

Interessante
Flor-Struktur mit
abgestimmten
Farbnuancen
Mit rutschhemmender
Latex-Beschichtung

Interesting pile structure with
coordinated colour nuances
Equipped with an anti-slip
Latex-coating

Structure intéressante du
velours avec
nuances de couleurs assorties
Avec revêtement Latex anti-
dérapant



398
Pearl



407
Old Rose



652
Schilf

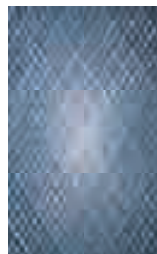

750
Navy

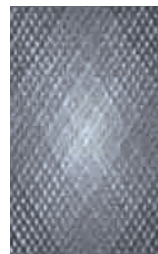

901
Anthrazit

100% Polyester



Florhöhe (mm)
Pile height
Hauteur mèches

24



9121 ... 135
ca. 60 x 60 cm



9121 ... 360
ca. 60 x 100 cm



9121 ... 225
ca. 70 x 120 cm



Mit rutschhemmender TPE-Beschichtung

Equipped with an anti-slip TPE-coating

Avec revêtement TPE anti-dérapant

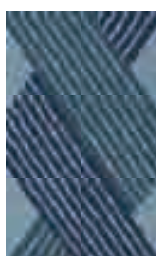

783
Mare
*754 Iceblue



901
Anthrazit
*901 Anthrazit

DESIGNWELT
EINFACH MEER



100 % Polyacryl



Florhöhe (mm)
Pile height
Hauteur mèches



8888 ... 104*
ca. 47 x 50 cm



9181 ... 129
ca. 55 x 55 cm



9181 ... 539
ca. 55 x 65 cm



9181 ... 360
ca. 60 x 100 cm

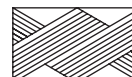

9181 ... 225
ca. 70 x 120 cm

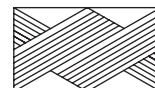

9181 ... 657
ca. 80 x 140 cm

CUBETTO



Mit rutschhemmender
TPE-Beschichtung

Equipped with an anti-slip
TPE-coating

Avec revêtement TPE anti-
dérapant



148
Multicolor

Jedes Kästchen in einer
anderen brillanten Farbe!

Every box in one
another brilliant color!

Chaque boîte en une
encore une couleur éclatante!

100% Polyacryl



Florhöhe (mm)
Pile height
Hauteur mèches

25



8821 ... 135
ca. 60 x 60 cm



8821 ... 213
ca. 65 x 90 cm



8821 ... 449
ca. 75 x 120 cm



8821 ... 693
ca. 85 x 145 cm



8821 ... 528
ca. 90 cm rund



Filigraner Digitaldruck
und extraweiche
Oberfläche
Mit rutschhemmender
TPE-Beschichtung

Filigree digital print and
super
soft fur look
Equipped with an anti-slip
TPE coating

Impression digitale filigrane
et aspect fourrure extra-
souple
Avec revêtement TPE anti-
dérapant



851
Lavendel

DESIGNWELT DAYDREAM



100 % Polyester



Florhöhe (mm)
Pile height
Hauteur mèches

5



9185 ... 433
ca. 50 x 60 cm



9185 ... 519
ca. 60 x 90 cm



9185 ... 225
ca. 70 x 120 cm

Das passt dazu:
That fits: / Ça correspond:

DAHLIA
Textiler Duschvorhang im
passenden Design
Shower curtain in matching design
Rideau de douche au design assorti
> Seite 213 / page 213





2-teiliges Badteppich-Set
mit Noppenoptik
Hergestellt aus
100% Baumwolle

2-piece bath rug set with
knobbed look
Made from 100% cotton

Set de 2 tapis de bain à picots
Fabriqué en 100% coton



202
Natur

100% Cotton



Florhöhe (mm)
Pile height
Hauteur mèches

6



5536 ... 907
ca. 50 x 40 cm + 50 x 80 cm

Das passt dazu:
That fits: / Ça correspond:

DOTTY
Accessoire-Serie mit feiner
Pünktchen-Struktur

With fine dot structure
Avec une structure à picots.

> Seite 14% / page 145



DREAM

NEW COLOUR



Mit rutschhemmender TPE-Beschichtung

Equipped with an anti-slip TPE-coating

Avec revêtement TPE anti-dérapant

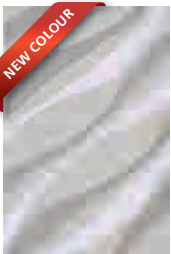

158
Auster



746
Stahlblau

DESIGNWELT DAYDREAM



100% Polyacryl



Florhöhe (mm)
Pile height
Hauteur mèches



9169 ... 539
ca. 55 x 65 cm

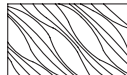

9169 ... 360
ca. 60 x 100 cm

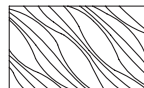

9169 ... 225
ca. 70 x 120 cm

FIONA



Badteppich im Farbverlauf mit Hoch-/Tiefoptik
Mit rutschhemmender TPE-Beschichtung

Bathroom rug featuring a colour gradient with high/low optic
Equipped With an anti-slip TPE-coating

Tapis de bain avec dégradé de couleurs et effet de relief/profondeur
Avec revêtement TPE anti-dérapant



270
Bahamabeige
*226 Sandbeige



428
Bordeaux
*415 Koralle

100% Polyacryl



Florhöhe (mm)
Pile height
Hauteur mèches



Florhöhe (mm)
Pile height
Hauteur mèches



8888 ... 104*
ca. 47 x 50 cm



9128 ... 130
ca. 55 x 50 cm



9128 ... 539
ca. 55 x 65 cm

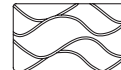

9128 ... 360
ca. 60 x 100 cm

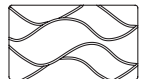

9128 ... 225
ca. 70 x 120 cm



Mit rutschhemmender TPE-Beschichtung

Equipped with an anti-slip TPE-coating

Avec revêtement TPE anti-dérapant



271
Taupe
*271 Taupe



327
Marsala
*114 Schneeweiß



901
Anthrazit
*901 Anthrazit

100% Polyacryl



Florhöhe (mm)

Pile height

Hauteur mèches

15

Deckelbezug (mm)

Lid cover

Housse

20



8888 ... 104*
ca. 47 x 50 cm



9168 ... 129
ca. 55 x 55 cm



9168 ... 539
ca. 55 x 65 cm



9168 ... 360
ca. 60 x 100 cm

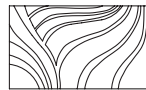

9168 ... 225
ca. 70 x 120 cm

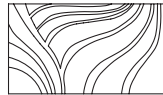

9168 ... 657
ca. 80 x 140 cm

FLORES



Digital bedruckter,
feiner Badteppich
mit rutschhemmender
TPE-Beschichtung

Digitally printed fine bath
mat with anti-slip TPE-coa-
ting

Tapis de bain fin imprimé
numériquement avec
revêtement TPE antidé-
rapant

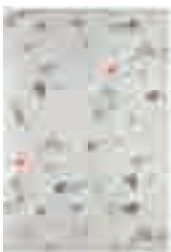

148
Multicolor

100% Polyester



Florhöhe (mm)
Pile height
Hauteur mèches

5



9161 ... 433
ca. 50 x 60 cm



9161 ... 519
ca. 60 x 90 cm



9161 ... 225
ca. 70 x 120 cm

Das passt dazu:
That fits: / Ça correspond:

FLORES
Textiler Duschvorhang im
passenden Design
Shower curtain in matching design
Rideau de douche au design assorti
> Seite 213 / page 213





Modernes Streifendesign
Hergestellt aus recycelter
Baumwolle

Modern striped design
Made from recycled cotton

Un design moderne à rayures
Fabriqué à partir de coton
recyclé



226
Sandbeige



325
Siena



698
Eucalyptus

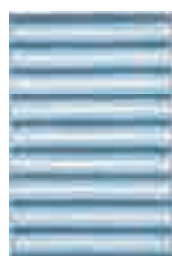

754
Iceblue

100% Cotton



Florhöhe (mm)
Pile height
Hauteur mèches



5538 ... 433
ca. 50 x 60 cm



5538 ... 519
ca. 60 x 90 cm



5538 ... 225
ca. 70 x 120 cm

GLOW

NEW



Streifenstruktur durch unterschiedliche Florhöhen
 Dezent Glanzeffekte
 Rutschhemmende Latexbeschichtung

Striped pattern created by varying pile heights
 Subtle gloss effects
 Equipped with an anti-slip Latex-coating

Structure en bande grâce aux différences hauteurs de poils
 Effets brillants discrets
 Avec revêtement Latex antidérapant



100
Weiß



158
Auster



616
Dill



851
Lavendel

100 % Polyester



Florhöhe (mm)
 Pile height
 Hauteur mèches



9186 ... 539
ca. 55 x 65 cm



9186 ... 360
ca. 60 x 100 cm



9186 ... 225
ca. 70 x 120 cm



Premium Produkt
Langstaplige Baumwolle mit hohem Gewicht
Doubleface - Optik

Luxury product
Deep pile heavyweight cotton
Reversible design

Produit de première qualité
Coton longue fibre au poids élevé
Aspect double face



146
Silbergrau



202
Natur



905
Schiefer

100% Cotton



Florhöhe (mm)
Pile height
Hauteur mèches

8	13
13	8



5418 ... 539
ca. 55 x 65 cm

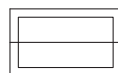

5418 ... 360
ca. 60 x 100 cm

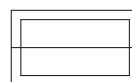

5418 ... 225
ca. 70 x 120 cm

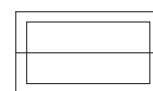

5418 ... 453
ca. 85 x 150 cm

HELENA



MICROFASER

Badteppich
mit Hoch-/ Tiefoptik-
Mit rutschhemmender
TPE-Beschichtung

Bath rug with high-low
effect
Equipped with an anti-slip
TPE-coating

Tapis de bain avec effet
haut-bas
Avec revêtement TPE anti-
dérapant



287
Kaschmir

100% Polyester / Microfaser



Florhöhe (mm)

Pile height
Hauteur mèches

10 15



5532 ... 433
ca. 50 x 60 cm

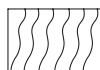

5532 ... 519
ca. 60 x 90 cm



5532 ... 225
ca. 70 x 120 cm



Zeitlose Uni-Optik
Rutschhemmende
Rückenbeschichtung

Timeless plain design
Non-slip backing

Aspect uni intemporel
Revêtement
antidérapant



100
Weiß



202
Natur



905
Schiefer

100% Cotton



Florhöhe (mm)
Pile height
Hauteur mèches

14



4018 ... 539
ca. 55 x 65 cm



4018 ... 519
ca. 60 x 90 cm



4018 ... 225
ca. 70 x 120 cm



4018 ... 657
ca. 80 x 140 cm

KARA

NEW



Karodesign mit besonderer Cut & Loop-Struktur
Rutschhemmende TPE-Beschichtung

Nice checkered design
Equipped with an anti-slip TPE-coating

Joli design à carreaux
Avec revêtement TPE antidérapant



158
Auster



616
Dill

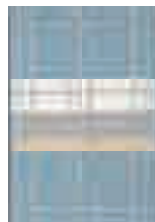

746
Stahlblau

Das passt dazu:
That fits: / Ça correspond:

DASH
> Seite 144 / page 144



100 % Polyacryl



Florhöhe (mm)
Pile height
Hauteur mèches

10



5543 ... 433
ca. 60 x 50 cm



5543 ... 519
ca. 60 x 90 cm

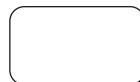

5543 ... 225
ca. 70 x 120 cm



Mit rutschhemmender
Latex-Beschichtung

Equipped with an anti-slip
Latex-coating

Avec revêtement Latex an-
tidérapant



685
Maledivia

Das passt dazu:
That fits: / Ça correspond:

LEAF
Textiler Duschvorhang
im passenden Design
Shower curtain in matching design
Rideau de douche au design assorti
> Seite 217 / page 217



100% Polyester



Florhöhe (mm)
Pile height
Hauteur mèches

12



9137 ... 433
ca. 50 x 60 cm



9137 ... 519
ca. 60 x 90 cm



9137 ... 225
ca. 70 x 120 cm



Modernes Design
Hoch-Tief-Effekt durch
Streifen in unter-
schiedlicher Florhöhe
Rutschhemmende
Rückenbeschichtung

Modern design
Stripes with different pile
for a high-low effect
Non-slip backing

Un design moderne
Effet de relief/profondeur
grâce aux rayures
Revêtement antidérapant



901
Anthrazit

100% Cotton



Florhöhe (mm)
Pile height
Hauteur mèches



5489 ... 539
ca. 55 x 65 cm

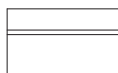

5489 ... 360
ca. 60 x 100 cm

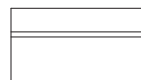

5489 ... 225
ca. 70 x 120 cm



Das passt dazu:
That fits / Ça correspond:

CUBIC

Zeitlose Accessoire-Serie aus Steinzeug
in vielen Farben

Timeless accessory series of stoneware in many
colors

Série d'accessoires intemporels en grès de nombreu-
ses couleurs

> Seite 143 / page 143



Handgewebter
Wendeteppich
mit weichen
Chenillefäden

Handwoven reversible rug
with soft chenille threads
Non-slip backing

Tapis double tissé à la main
avec du fil chenille souple
Revêtement antidérapant



226
Sandbeige



304
Terracotta



685
Maledivia

65% Polyester / 35% Cotton



Florhöhe (mm)
Pile height
Hauteur mèches

12



9173 ... 539
ca. 55 x 65 cm



9173 ... 519
ca. 60 x 90 cm



9173 ... 225
ca. 70 x 120 cm

Das passt dazu:
That fits: / Ça correspond:



CRACKLE
Accessoire-Serie aus Polyresin
Accessory series made of polyresin
Série d'accessoires en polyrésine
> Seite 142 / page 142

LOUNGE



Handgewebter
Badteppich aus
Bändchengarn
Mit rutschhemmender
Beschichtung

Hand-woven bath rug made
from ribbon yarn
Equipped with an anti-slip
coating

Tapis de bain tissé à la
main en
Avec revêtement TPE anti-
dérapant



271
Taupe



905
Schiefer

75% Polyester / 25% Cotton



Florhöhe (mm)
Pile height
Hauteur mèches

23



4000 ... 135
ca. 60 x 60 cm



4000 ... 360
ca. 60 x 100 cm



4000 ... 225
ca. 70 x 120 cm

Das passt dazu:
That fits: / Ça correspond:

GLOSSY
Schwingdeckeleimer in vielen
Farben, 5 Liter

Swing bin, 5 litres
Poubelle à couvercle
basculant, 5 litres

> Seite 170 / page 170





Mit rutschhemmender
TPE-Beschichtung

Equipped with an anti-slip
TPE-coating

Avec revêtement TPE antidé-
rapant



754
Iceblue
*754 Iceblue

905
Schiefer
*901 Anthrazit

100% Polyacryl



Florhöhe (mm)
Pile height
Hauteur mèches

20

Deckelbezug (mm)
Lid cover
Housse

20



8888 ... 104*
ca. 47 x 50 cm



9144 ... 539
ca. 55 x 65 cm



9144 ... 519
ca. 60 x 90 cm



9144 ... 225
ca. 70 x 120 cm

NEW



Hergestellt aus
recyceltem Polyester
Mit rutschhemmender
TPE-Beschichtung

Made of recycled polyester
Equipped with an anti-slip
TPE-coating

Fait de polyester recyclé
Avec revêtement TPE anti-
dérapant



100
Weiß



146
Silbergrau



226
Sandbeige



468
Granat



612
Forest



746
Stahlblau



901
Anthrazit

100% Polyester



Florhöhe (mm)
Pile height
Hauteur mèches

20



9184 ... 433
ca. 50 x 60 cm



9184 ... 519
ca. 60 x 90 cm

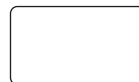

9184 ... 225
ca. 70 x 120 cm



Mit rutschhemmender
TPE-Beschichtung

Equipped with an anti-slip
TPE-coating

Avec revêtement TPE anti-
dérapant



100
Weiß

146
Silbergrau

270
Bahamabeige

327
Marsala

649
Opal

698
Eucalyptus

783
Mare

905
Schiefer

100% Polyester



Florhöhe (mm)
Pile height
Hauteur mèches

30



9116 ... 433
ca. 50 x 60 cm



9116 ... 519
ca. 60 x 90 cm

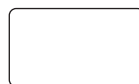

9116 ... 225
ca. 70 x 120 cm



9116 ... 657
ca. 80 x 140 cm

MERIDA



Weicher Flor
Hochwertige Cotton
Interessante 2-Farbigkeit

Soft pile
High quality wool
Interesting dual colour scheme

Fibres douces
Coton de haute qualité
Look bicolore attrayant

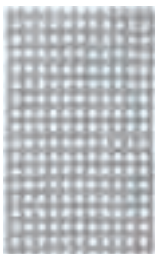

146
Silbergrau

100% Cotton



Florhöhe (mm)
Pile height
Hauteur mèches

12



4036 ... 135
ca. 60 x 60 cm

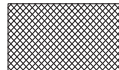

4036 ... 360
ca. 60 x 100 cm

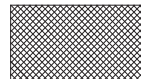

4036 ... 225
ca. 70 x 120 cm

Das passt dazu:
That fits: / Ça correspond:

SILENCE
Treteimer mit SoftClose, 3 Liter

Pedal bin with SoftClose, content 3 litres
Poubelle à pédale avec SoftClose, contenu 3 litres

> Seite 171 / page 171





Badteppich in Wellenoptik
Mit rutschhemmender TPE-Beschichtung

Bath rug in wave optics
Equipped with an anti-slip TPE-coating

Tapis de bain en l'optique ondulatoire
Avec revêtement TPE antidérapant



215
Naturbeige
* 224 Toffee



633
Minze
* 619 Linde



791
Himmelblau



905
Schiefer
* 901 Anthrazit

100% Polyacryl



Florhöhe (mm)

Pile height
Hauteur mèches

15

Deckelbezug (mm)

Lid cover
Housse

20



8888 ... 104
ca. 47 x 50 cm



5510 ... 433
ca. 50 x 60 cm



5510 ... 556
ca. 60 x 90 cm

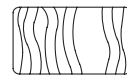

5510 ... 427
ca. 65 x 115 cm



Foam-Badteppich mit weicher Velours-oberfläche und Struktur
Mit rutschhemmender TPE-Beschichtung

Foam bath rug with soft velour surface and structure
Equipped with an anti-slip TPE-coating

Tapis de bain en mousse avec surface douce
Avec revêtement TPE antidérapant



146
Silbergrau

226
Sandbeige

783
Mare

90% Polyester / 10% Nylon



Florhöhe (mm)
Pile height
Hauteur mèches

5

5541 ... 207
ca. 50 x 80 cm



Mit rutschhemmender TPE-Beschichtung

Equipped with an anti-slip TPE-coating

Avec revêtement TPE anti-dérapant



271
Taupe



769
Marineblau

100% Polyacryl



Florhöhe (mm)
Pile height
Hauteur mèches



Deckelbezug (mm)
Lid cover
Housse



8888 ... 104
ca. 47 x 50 cm



9107 ... 331
ca. 55 x 65 cm

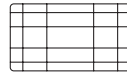

9107 ... 360
ca. 60 x 100 cm

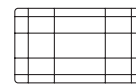

9107 ... 311
ca. 70 x 120 cm

MONROVIA



Badteppich im Streifen-
design mit geschnittenem
Flor und Schlingen
Mit rutschhemmender
Beschichtung

Bath rug in striped design
with cut pile and loops
Equipped with an anti-slip
coating

Tapis de bain à rayures avec
mèches coupés et boucles
Avec revêtement antidérapant



226
Sandbeige



287
Kaschmir

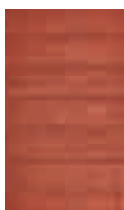

304
Terracotta



407
Old Rose



685
Maledivita



750
Navy



977
Platin

100% Polyester



Florhöhe (mm)
Pile height
Hauteur mèches



4094 ... 135
ca. 60 x 60 cm



4094 ... 360
ca. 60 x 100 cm



4094 ... 225
ca. 70 x 120 cm

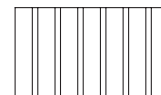

4094 ... 657
ca. 80 x 140 cm



Attraktives Struktur-Design mit Hoch-Tief-Optik und weicher Oberfläche
 Mit recycelter Baumwolle
 Mit rutschhemmender Beschichtung

Attractive textured design in a high-low style and soft surface
 Made with recycled cotton
 Equipped with an anti-slip coating

Beau design avec effet de relief/profondeur et surface douce
 Fabriqué avec du coton recyclé
 Avec revêtement antidérapant



537
Solaris

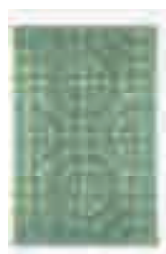

685
Maledivia

Das passt dazu:
That fits: / Ça correspond:

CLAP
Schwingdeckeleimer, 5 Liter
Swing bin, content 5 litres
Poubelle à couvercle basculant, contenu 5 litres

> Seite 170 / page 170



100% Cotton



Florhöhe (mm)
Pile height
Hauteur mèches



9167 ... 433
ca. 50 x 60 cm

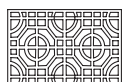

9167 ... 519
ca. 60 x 90 cm

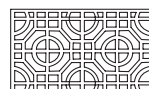

9167 ... 225
ca. 70 x 120 cm

NET



Cut-/Loop Effekt mit attraktiver Struktur
Mit rutschhemmender Beschichtung

Cut/loop effect with an attractive texture
Equipped with an anti-slip coating

Effet cut/loop avec une structure attirante
Avec revêtement antidérapant



202
Natur



304
Terracotta



397
Papaya



652
Schilf



746
Stahlblau

100% Cotton



Florhöhe (mm)
Pile height
Hauteur mèches



9171 ... 135
ca. 60 x 60 cm

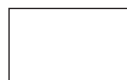

9171 ... 519
ca. 60 x 90 cm



9171 ... 225
ca. 70 x 120 cm



9171 ... 657
ca. 80 x 140 cm



Sehr weiche Oberfläche
und filigraner Digital-
druck mit City Map
Mit rutschhemmender
Beschichtung

Super soft surface and filigree
digital print with City Map
Equipped with an anti-slip
coating

Une surface très souple et
une impression digitale filig-
rane avec City Map
Avec revêtement antidérapant



158
Auster

100 % Polyester



Florhöhe (mm)

Pile height
Hauteur mèches

8



5540 ... 207
ca. 50 x 80 cm

NEW



Micro-Polyester
mit besonders
weicher Oberfläche
Rutschhemmende
Latexbeschichtung

Micro polyester
with very soft surface
Equipped with an anti-slip
coating

Micro-polyester avec spécial
surface molle
Avec revêtement antidérapant



146
Silbergrau



738
Hellblau

DESIGNWELT EINFACH MEER



100 % Polyester



Florhöhe (mm)
Pile height
Hauteur mèches

15



9187 ... 135
ca. 60 x 60 cm



9187 ... 519
ca. 60 x 90 cm



9187 ... 225
ca. 70 x 120 cm



Mit rutschhemmender Beschichtung

Equipped with an anti-slip coating

Avec revêtement antidérapant



311
Mahagoni



783
Mare



977
Platin

100% Polyester



Florhöhe (mm)
Pile height
Hauteur mèches

30



4077 ... 135
ca. 60 x 60 cm



4077 ... 519
ca. 60 x 90 cm



4077 ... 225
ca. 70 x 120 cm

PHOENIX



Weicher Flor
Hochwertige
Baumwolle
Mit rutschhemmender
Beschichtung
Hoch-/Tiefeffekt durch
weiße Streifen in
niedriger Florhöhe

Soft pile
High quality wool
2 different pile heights
Equipped with an anti-slip
coating
High/low effect created by
stripes at low pile height

Fibres douces
Coton de haute qualité
2 hauteurs mèches différentes
Avec revêtement antidérapant
Effet de relief/profondeur
grâce aux rayures et aux poils
courts de l'article



146
Silbergrau



271
Taupe

85% Cotton / 15% Polyester



4045 ... 135
ca. 60 x 60 cm

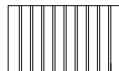

4045 ... 360
ca. 60 x 100 cm



4045 ... 225
ca. 70 x 120 cm

Florhöhe (mm)
Pile height
Hauteur mèches



NEW



Wellendesign durch Übertuft
Flauschiger Griff
Rutschemmende Latex-Beschichtung

Wave design by overtufting
Fluffy and soft surface
Equipped with an anti-slip coating

Conception de vagues en surfaçant
Tapis moelleux
Avec revêtement antidérapant



158
Auster



226
Sandbeige



746
Stahlblau

DESIGNWELT
EINFACH MEER



Das passt dazu:
That fits: / Ça correspond:

NAVAGIO
> Seite 156 / page 156

100 % Polyester



Florhöhe (mm)
Pile height
Hauteur mèches



9180 ... 539
ca. 55 x 65 cm

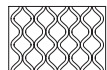

9180 ... 519
ca. 60 x 90 cm



9180 ... 225
ca. 70 x 120 cm



NEW



Webteppich mit
feiner Struktur
Mit rutschhemmender
Rückenbeschichtung

Woven carpet with
fine structure
Equipped with an anti-slip
coating

Tapis tissé avec
structure fine
Avec revêtement antidérapant



100
Weiß



158
Auster



616
Dill



851
Lavendel

DESIGNWELT DAYDREAM



Das passt dazu:
That fits: / Ça correspond:

ADONA
> Seite 133 / page 133



100 % Cotton



Florhöhe (mm)
Pile height
Hauteur mèches

5



9182 ... 433
ca. 50 x 60 cm

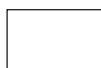

9182 ... 519
ca. 60 x 90 cm



9182 ... 225
ca. 70 x 120 cm



Mit rutschhemmender Beschichtung

Equipped with an anti-slip coating

Avec revêtement antidérapant



146
Silbergrau

100% Polyester



Florhöhe (mm)
Pile height
Hauteur mèches



5471 ... 135
ca. 60 x 60 cm



5471 ... 360
ca. 60 x 100 cm



5471 ... 225
ca. 70 x 120 cm

Das passt dazu:
That fits: / Ça correspond:

ROYAL
Als Gästetuch, Handtuch
oder Duschtuch.

Guest towel, hand towel
or bath towel.
Serviette invités, serviette de
toilette ou serviette de bain.

> Seite 100 / page 100



RUMBA



MICROFASER

Mit rutschhemmender
Latex-Beschichtung

Equipped with an anti-slip
latex-coating

Avec revêtement antidé-
pant en latex



202
Natur

100% Polyester / Microfaser



Florhöhe (mm)

Pile height
Hauteur mèches

25



5502 ... 256
ca. 65 x 50 cm



5502 ... 360
ca. 60 x 100 cm



5502 ... 225
ca. 70 x 120 cm



Filigraner Digitaldruck
und extra weiche
Felloptik
Mit Samtband eingefasst
Mit rutschhemmender
TPE-Beschichtung

Filigree digital print and super
soft fur look
Velvet binding
Equipped with an anti-slip
TPE coating

Impression digitale filigrane et
aspect fourrure extra-souple
Avec un ruban de velours en
bordure
Avec revêtement TPE antidé-
rapant



148
Multicolor

Das passt dazu:
That fits: / Ça correspond:

SAVANNAH
> Seite 161 / page 161



100% Polyester



Florhöhe (mm)
Pile height
Hauteur mèches

5



9166 ... 519
ca. 60 x 90 cm



9166 ... 225
ca. 70 x 120 cm

SEATTLE



Mit rutschhemmender Beschichtung

Equipped with an anti-slip coating

Avec revêtement antidérapant

Melange

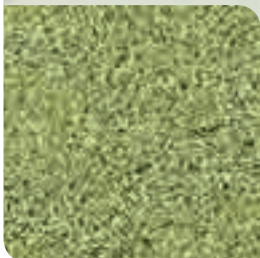

202
Natur



271
Taupe



468
Granat



615
Kiwigrün



754
Iceblue



905
Schiefer



913
Nebel

100% Polyester



4071 ... 130
ca. 55 x 50 cm



4071 ... 539
ca. 55 x 65 cm



4071 ... 519
ca. 60 x 90 cm



4071 ... 225
ca. 70 x 120 cm

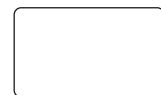

4071 ... 657
ca. 80 x 140 cm

Florhöhe (mm)
Pile height
Hauteur mèches

25

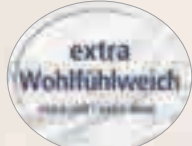

Digital bedruckter, feiner Badteppich mit rutschhemmender TPE-Beschichtung

Digitally printed fine bath mat with anti-slip TPE-coating

Tapis de bain fin imprimé numériquement avec revêtement TPE antidérapant



612 Forest

DESIGNWELT
NEUE ERNTE



Das passt dazu:
That fits: / Ça correspond:

SELVA
Textiler Duschvorhang im passenden Design
Shower curtain in matching design
Rideau de douche au design assorti
> Seite 221 / page 221



100 % Polyester



Florhöhe (mm)
Pile height
Hauteur mèches

5



9190 ... 433
ca. 50 x 60 cm



9190 ... 519
ca. 60 x 90 cm



9190 ... 225
ca. 70 x 120 cm

SEAWORLD



Badteppich mit
maritimen Motiven
Mit rutschhemmender
TPE-Beschichtung

Bath rug with maritime
motifs
Equipped with an anti-slip
TPE-coating

Tapis de bain aux motifs
maritimes
Avec revêtement TPE
antidérapant

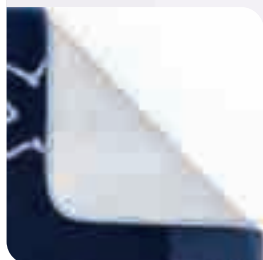

769
Marineblau
*769 Marineblau

100% Polyacryl



Florhöhe (mm)

Pile height
Hauteur mèches

20

Deckelbezug (mm)

Lid cover
Housse

20



8888 ... 104*
ca. 47 x 50 cm



5515 ... 256
ca. 50 x 65 cm



5515 ... 360
ca. 60 x 100 cm



5515 ... 225
ca. 70 x 120 cm

Das passt dazu:

That fits: / Ça correspond:

MUSCHEL

Dekomotive mit Saugnäpfen

Dekomotive with suction cups
Décomotive à ventouses

> Seite 256 / page 256





Mit rutschhemmender TPE-Beschichtung

Equipped with an anti-slip TPE-coating

Avec revêtement TPE antidérapant



289
Seide
* 271 Taupe



913
Nebel
* 977 Platin

100% Polyacryl



Florhöhe (mm)

Pile height
Hauteur mèches

20

Deckelbezug (mm)

Lid cover
Housse

20



8888 ... 104*
ca. 47 x 50 cm



5518 ... 433
ca. 50 x 60 cm



5518 ... 556
ca. 60 x 90 cm



5518 ... 225
ca. 70 x 120 cm

SWAY



Eine neue Struktur in toniger Melange aus geschnittenem Flor und Schlingen
Mit rutschhemmender Beschichtung

A new structure in tonal blends made from dense cut pile and loop pile
Equipped with an anti-slip coating

Une nouvelle structure chinée ton sur ton, en fibres coupées et boucles
Avec revêtement antidérapant

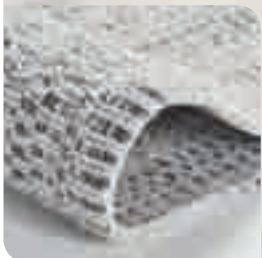

977
Platin

100% Cotton



Florhöhe (mm)
Pile height
Hauteur mèches

10



9108 ... 135
ca. 60 x 60 cm



9108 ... 360
ca. 60 x 100 cm



9108 ... 225
ca. 70 x 120 cm



Weicher Badteppich mit Hoch-Tief-Effekt
Mit rutschhemmender Latex-Beschichtung

Soft bath rug with high-low effect
Equipped with an anti-slip latex-coating

Tapis de bain doux avec effet haut-bas
Avec revêtement latex anti-dérapant



226
Sandbeige



649
Opal



652
Schilf



901
Anthrazit

100% Polyester



4099 ... 135
ca. 60 x 60 cm



4099 ... 360
ca. 60 x 100 cm

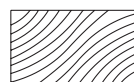

4099 ... 225
ca. 70 x 120 cm

Florhöhe (mm)
Pile height
Hauteur mèches



TERRACE



Neue Grüntöne
passend zum Trend
Außergewöhnliches
Strukturdesign mit
Hoch-Tief-Effekt
Mit rutschhemmender
TPE-Beschichtung

New shades of green to fit
the trend
Unusual texture created
using high-low weave
Equipped with an anti-slip
TPE-coating

Nouvelles teintes de vert
tendance
Design à la structure ex-
ceptionnelle avec effet de
grande profondeur
Avec revêtement TPE anti-
dérapant



226
Sandbeige



453
Rubin



616
Dill

DESIGNWELT NEUE ERNTE



100 % Polyacryl



Florhöhe (mm)
Pile height
Hauteur mèches



9183 ... 539
ca. 55 x 65 cm



9183 ... 360
ca. 60 x 100 cm



9183 ... 225
ca. 70 x 120 cm

Das passt dazu:

That fits: / Ça correspond:

DASH

> Seite 144 / page 144





Mit **BIO**-Baumwolle
Mit Hoch-/Tiefeffekt
durch unterschiedliche
Florhöhen
Mit rutschhemmender
Rückenbeschichtung

With organic cotton
With high/low effect through
different Pile heights Equip-
ped with an anti-slip coating

Avec du coton biologique
Avec effet haut/bas à
travers différents
Hauteurs de pieux
Avec revêtement antidérapant



146
Silbergrau



202
Natur



401
Nelke

Das passt dazu:

That fits: / Ça correspond:

PUNTA
> Seite 176 / page 176



100% Cotton



Florhöhe (mm)

Pile height
Hauteur mèches



9155 ... 539
ca. 55 x 65 cm

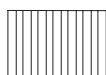

9155 ... 519
ca. 60 x 90 cm

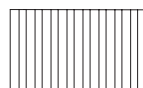

9155 ... 225
ca. 70 x 120 cm

TILES

NEW COLOUR



Hergestellt mit recycelter Baumwolle
Mit rutschhemmender Beschichtung

Made with recycled cotton
Equipped with an anti-slip coating

Fabriqué avec du coton recyclé
Avec revêtement antidérapant



202
Natur



342
Brasil



612
Forest

DESIGNWELT NEUE ERNTE



100% Cotton



Florhöhe (mm)

Pile height
Hauteur mèches



9176 ... 135
ca. 60 x 60 cm



9176 ... 360
ca. 60 x 100 cm



9176 ... 225
ca. 70 x 120 cm



Moderne Bi-Color Optik
mit Troddeln
Mit rutschhemmender
Rückenbeschichtung

Modern dual-colour look with
tassels
Equipped with an anti-slip
coating

Optique bicolore moderne
avec des houppes
Avec revêtement antidérapant



202
Natur

926
Schwarz

Das passt dazu:
That fits: / Ça correspond:

RUNA
Accessoire-Serie
mit Rillenstruktur
Accessory series
with groove structure
Série d'accessoires
avec structure à rainures
> Seite 160 / page 160



100% Cotton



Florhöhe (mm)
Pile height
Hauteur mèches

14



9158 ... 539
ca. 55 x 65 cm



9158 ... 519
ca. 60 x 90 cm



9158 ... 225
ca. 70 x 120 cm



9158 ... 657
ca. 80 x 140 cm

TRAM

NEW



Attraktives Wellen-
design mit
Hoch-Tief-Optik
Mit rutschhemmender
TPE-Beschichtung

Appealing wave pattern
with high-low appearance
Equipped with an anti-slip
TPE-coating

Design de vagues attractif
avec aspect de grande
profondeur
Avec revêtement TPE anti-
dérapant



256
Caramel



468
Granat



612
Forest



783
Mare



901
Anthrazit

DESIGNWELT

EINFACH MEER



100 % Polyacryl



Florhöhe (mm)
Pile height
Hauteur mèches



9189 ... 129
ca. 55 x 55 cm



9189 ... 539
ca. 55 x 65 cm



9189 ... 360
ca. 60 x 100 cm



9189 ... 225
ca. 70 x 120 cm



9189 ... 657
ca. 80 x 140 cm



Mit rutschhemmender
TPE-Beschichtung

Equipped with an anti-slip
TPE-coating

Avec revêtement TPE anti-
dérapant

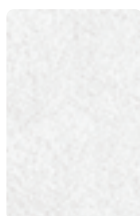

100
WeiB



905
Schiefer

100% Polyester



Florhöhe (mm)
Pile height
Hauteur mèches

35



4035 ... 539
ca. 55 x 65 cm



4035 ... 556
ca. 60 x 90 cm



4035 ... 225
ca. 70 x 120 cm

Das passt dazu:
That fits: / Ça correspond:

JACKSONS
WC-Sitz mit
Absenkautomatik

WC seat with soft-close mechanism
Abattants WC avec mécanisme de
fermeture souple

> Seite 202 / page 202



NEW

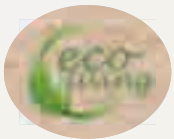

Attraktives Wellendesign
Mit Quasten an den schmalen Seiten
Mit rutschhemmender Beschichtung

Appealing wave pattern
With tassels on the short sides
Equipped with an anti-slip coating

Design de vagues attractif
Houppes sur les côtés fins
Avec revêtement antidérapant



202
Natur



616
Dill

DESIGNWELT EINFACH MEER



100% Cotton



Florhöhe (mm)
Pile height
Hauteur mèches

12



9179 ... 135
ca. 60 x 60 cm



9179 ... 519
ca. 60 x 90 cm



9179 ... 225
ca. 70 x 120 cm

Das passt dazu:

That fits: / Ça correspond:

BAO

> Seite 98 / page 98





Mehrfarbiges Wellenmotiv mit Hoch/Tief-optik
Mit rutschhemmender TPE-Beschichtung

Multi-colored wave motif with high-low effect
Equipped with an anti-slip TPE-coating

Motif d'onde multicolore avec effet haut-bas
Avec revêtement TPE antidérapant



225
Rehbraun
* 224 Toffee



977
Platin
* 977 Platin

100% Polyacryl



Florhöhe (mm)
Pile height
Hauteur mèches



Deckelbezug (mm)
Lid cover
Housse



8888 ... 104*
ca. 47 x 50 cm



5503 ... 129
ca. 55 x 55 cm



5503 ... 539
ca. 55 x 65 cm



5503 ... 360
ca. 60 x 100 cm

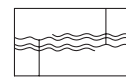

5503 ... 225
ca. 70 x 120 cm



Mit rutschhemmender Beschichtung

Equipped with an anti-slip coating

Avec revêtement antidérapant



100
Weiß

226
Sandbeige

685
Maledivia

783
Mare

926
Schwarz

977
Platin



Gerollte Aufmachung mit Schlaufe für hängende Platzierung

Rolled presentation with loop for hanging placement

Présentation roulée avec boucle pour un placement suspendu

100% Cotton



Florhöhe (mm)
Pile height
Hauteur mèches

12

9159 ... 207
ca. 50 x 80 cm



Badteppich mit Hoch-/Tiefoptik in geschwungenen harmonischen Farbabstufungen
Mit rutschhemmender TPE-Beschichtung

Bath rug with high-low effect and curved color gradations
Equipped with an anti-slip TPE-coating

Tapis de bain avec effet haut-bas et gradations de couleurs
Avec revêtement TPE antidérapant

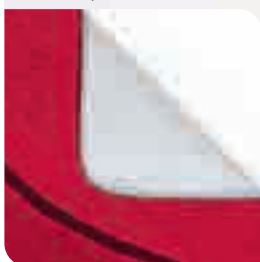

453
Rubin
* 453 Rubin



769
Marineblau
* 769 Marineblau

100% Polyacryl



Florhöhe (mm)
Pile height
Hauteur mèches



Deckelbezug (mm)
Lid cover
Housse



8888 ... 104*
ca. 47 x 50 cm



5507 ... 129
ca. 55 x 55 cm



5507 ... 539
ca. 55 x 65 cm



5507 ... 556
ca. 60 x 90 cm

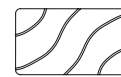

5507 ... 225
ca. 70 x 120 cm

WILLOW



Webteppich
aus weichen
Chenille-Band
Mit rutschhemmender
Beschichtung

Woven bath rug made from
soft chenille ribbon
Equipped with an anti-slip
coating

Tapis de bain tissé en bande
chenille douce
Avec revêtement antidé-
rapant



271
Taupe



977
Platin

55% Polyester + 45% Cotton



Florhöhe (mm)
Pile height
Hauteur mèches

10



9109 ... 135
ca. 60 x 60 cm



9109 ... 360
ca. 60 x 100 cm



9109 ... 225
ca. 70 x 120 cm



Mit rutschhemmender
TPE-Beschichtung

Equipped with an anti-slip
TPE-coating

Avec revêtement TPE anti-
dérapant

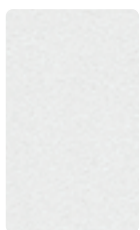

100
Weiß



146
Silbergrau



271
Taupe



453
Rubin



672
Türkis



712
Sorr.-Azurblau



905
Schiefer

100% Polyester



Florhöhe (mm)
Pile height
Hauteur mèches

18



5527 ... 433
ca. 50 x 60 cm



5527 ... 519
ca. 60 x 90 cm



5527 ... 225
ca. 70 x 120 cm



Wendeteppich aus
100% recycelter
Baumwolle
Eine Seite mit ge-
schnittenem Flor die
andere Seite mit
Schlingen gefertigt.

Reversible carpet made of
100% recycled cotton.
One side with cut pile the
other side with slings made.

Tapis réversible en coton
100% recyclé.
Un côté avec une pile
coupée, l'autre côté avec les
frondes sont faites.

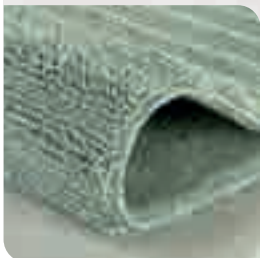

202
Natur



685
Maledivia



905
Schiefer

100% Cotton



Florhöhe (mm)
Pile height
Hauteur mèches

7	18
7	7



9156 ... 433
ca. 50 x 60 cm

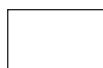

9156 ... 360
ca. 60 x 100 cm



9156 ... 225
ca. 70 x 120 cm



Frische Farben
Hergestellt aus
100 % Baumwolle

Fresh colours
Made with 100% cotton

Des couleurs fraîches
Fabriqué avec du coton



100
Weiß



791
Himmelblau



901
Anthrazit

100% Cotton



Florhöhe (mm)
Pile height
Hauteur mèches

22



5529 ... 433
ca. 50 x 60 cm



5529 ... 270
ca. 55 x 85 cm



5529 ... 427
ca. 65 x 115 cm



Weicher Flor
Besondere
Fischgrät-Struktur
Mit Rutschhemmender
TPE-Beschichtung

Distinctive herringbone
texture
Equipped with an anti-slip
TPE-coating

Structure en chevrons spé-
cifique
Avec revêtement TPE antidé-
rapant



226
Sandbeige



738
Hellblau

DESIGNWELT EINFACH MEER



100 % Polyester



Florhöhe (mm)
Pile height
Hauteur mèches

10



9178 ... 433
ca. 50 x 60 cm



9178 ... 519
ca. 60 x 90 cm



9178 ... 225
ca. 70 x 120 cm

Das passt dazu:
That fits: / Ça correspond:

SARDINAS
> Seite 162 / page 162



SOFT DECKEL

100% Polyacryl



Deckelbezug (mm)
Lid cover
Housse

20

Schnelles Fixieren durch Zugband

Quick fixation through drawstring
Fixation rapide grâce au cordon de serrage



8888 ... 104
ca. 47 x 50 cm



114
Schneeweiß



224
Toffee



226
Sandbeige



271
Taupe



316
Rost



415
Koralle



436
Beere



453
Rubin



539
Safran

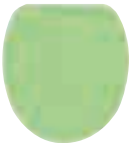

619
Linde



675
Petrol



685
Maledivia



754
Iceblue



769
Marineblau



901
Anthrazit



977
Platin

ANTI-RUTSCH

100% Polyester



Teppichunterlage

Rutschhemmend auf allen glatten und harten Böden
Zuschneidbar auf die gewünschte Badteppichgröße

Anti-slide carpet underlayer

To avoid carpet movements!
Can be cut to the desired size of the bath rug

Support de tapis antidérapant

Ne glisse pas quelque soit la nature du sol, qu'il soit lisse ou dur!
Peut être découpé à la taille du tapis de bain souhaité



100
Weiß

5444 100 225
ca. 70 x 120 cm



MORNING



158
Auster

Nutzschicht 100 % Polyester /
Trägermaterial 100 % Kautschuk

Wear layer 100% polyester / backing 100% rubber

Matériau de surface 100 % polyester /
matériau sous-jacent 100 % caoutchouc



Höhe (mm)
Height
Hauteur

4

9177 ... 207
ca. 50 x 80 cm

Das passt dazu:
That fits: / Ça correspond:

BELGRANO
Accessoire-Serie
hergestellt mit Bambushäckseln

Accessory series
made with bamboo chaff
Série d'accessoires fabriqués
avec bambou haché

> Seite 136 / page 136





158
Auster

Nutzschicht 100 % Polyester /
Trägermaterial 100 % Kautschuk

Wear layer 100% polyester / backing 100% rubber

Matériau de surface 100 % polyester /
matériau sous-jacent 100 % caoutchouc



Höhe (mm)
Height
Hauteur

4



9175 ... 207
ca. 50 x 80 cm

Das passt dazu:
That fits: / Ça correspond:

RICA
Duschvorhang aus
recycltem Polyester

Shower curtain in matching design
Rideau de douche au design assorti
> Seite 219 / page 219



LODGE FROTTIERVORLEGER TERRY RUG / TAPIS ÉPONGE



Kollektion aus veganen Materialien

Die Kleine Wolke Handtücher und Frotteivorleger sind mit dem V-Label gekennzeichnet. Das V-Label ist ein international anerkanntes, geschütztes Siegel für vegane und vegetarische Produkte.



Kleine Wolke towels and terry mats are labelled with the V-label. The V-label is an internationally recognised, protected seal for vegan and vegetarian products.

Les serviettes de toilette Kleine Wolke et de tapis de bain portent le V-label. Le V-label est un label protégé et reconnu internationalement pour les produits végétaliens et végétariens.



114
Schneeweiß



226
Sandbeige



327
Marsala



683
Smaragd



685
Maledivia



746
Stahlblau



912
Dunkelgrau



926
Schwarz



977
Platin

100% Cotton



Gewicht: 800 g/m²

Weight: 800 g/qm

Poids: 800 g/qm

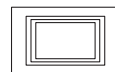

3009 ... 207
ca. 50 x 80 cm



TERRY RUG / TAPIS ÉPONGE FROTTIERVORLEGER BRIDGE



100
Weiß



133
Basalt



723
Azur



912
Dunkelgrau

100% Cotton



Gewicht: 700 g/m²
Weight: 700 g/qm
Poids: 700 g/qm

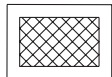

3016 ... 442
ca. 50 x 70 cm



TERRY RUG / TAPIS ÉPONGE FROTTIERVORLEGER STRADA



114
Schneeweiß



905
Schiefer

100% Cotton



Jacquardgewebe 1000 g/m²
Weight: 1000 g/qm
Poids: 1000 g/qm

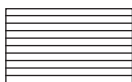

3032 ... 360
ca. 60 x 100 cm





114 Schneeweiß



220 Champagner



655 Linde



783 Mare



851 Lavendel

*Besonders weiche Qualität
aus Bambus & Baumwolle*

Very soft quality made from bamboo and cotton
Qualité particulièrement douce en bambou et coton

70% Viskose / 30% Cotton



Gewicht 500 g/m²

Weight: 500 g/qm
Poids: 500 g/qm

3040 ... 210
Waschhandschuh

Wash Mitt
Gant de toilette

ca. 16 x 21 cm

3040 ... 201
Gäsetuch

Guest Towel
Serviette d'invités

ca. 30 x 50 cm

3040 ... 262
Handtuch

Hand Towel
Serviette de toilette

ca. 50 x 100 cm

3040 ... 226
Duschtuch

Bath Towel
Serviette de bain

ca. 70 x 140 cm





685
Maledivia

3027 ... 262
Handtuch
Hand Towel
Serviette de toilette

ca. 50 x 100 cm

3027 ... 226
Duschtuch
Bath Towel
Serviette de bain

ca. 70 x 140 cm

100% Cotton



Jacquardgewebe 500 g/m²

Weight: 500 g/qm

Poids: 500 g/qm



289
Seide

3037 ... 937
Gästetuch
Guest Towel
Serviette d'invités

ca. 30 x 50 cm / Set 2 Stck.

3037 ... 262
Handtuch
Hand Towel
Serviette de toilette

ca. 50 x 100 cm

100% Cotton



Gewicht: 500 g/m²

Weight: 500 g/qm

Poids: 500 g/qm

Handtuch mit Stickerei
Embroidered Towel
Serviette brodée



ROYAL FROTTIERHANDTUCH TERRY TOWEL / SERVIETTE ÉPONGE



114 Schneeweiß	133 Basalt	226 Sandbeige	327 Marsala	612 Forest	685 Maledivia	746 Stahlblau	912 Dunkelgrau	926 Schwarz	977 Platin
--------------------------	----------------------	-------------------------	-----------------------	----------------------	-------------------------	-------------------------	--------------------------	-----------------------	----------------------

100% Cotton



Gewicht: 500 g/m²
Weight: 500 g/qm
Poids: 500 g/qm

3003 ... 201
Gästetuch
Guest Towel
Serviette d'invités
ca. 30 x 50 cm

3003 ... 262
Handtuch
Hand Towel
Serviette de toilette
ca. 50 x 100 cm

3003 ... 226
Duschtuch
Bath Towel
Serviette de bain
ca. 70 x 140 cm



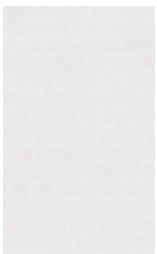

114
Schneeweiß



158
Auster



905
Schiefer

100% Cotton



Gewicht: 600 g/m²
Weight: 600 g/qm
Poids: 600 g/qm

3033 ... 262
Handtuch
Hand Towel
Serviette de toilette
ca. 50 x 100 cm

3033 ... 226
Duschtuch
Bath Towel
Serviette de bain
ca. 70 x 140 cm



BAMBUS



202
Natur



Für Fußbodenheizung geeignet
Suitable for underfloor heating
Approprié au chauffage de sol

Höhe (mm)
Height
Hauteur

5



5043 ... 207
ca. 50 x 80 cm

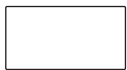

5043 ... 455
ca. 60 x 115 cm

Bambus / Bamboo / Bambou



Rückseite mit Vlies
ausgestattet

Reverse side fitted with fleece

Revers équipé d'un revête-
ment non tissé.



LEVEL



202
Natur



Für Fußbodenheizung geeignet
Suitable for underfloor heating
Approprié au chauffage de sol

Höhe (mm)
Height
Hauteur

8



4072 ... 207
ca. 50 x 80 cm



4072 ... 455
ca. 60 x 115 cm

Bambus / Bamboo / Bambou



Mit rutschhemmenden
Moosgummistreifen

With anti-slip foam rubber
strips

Avec des bandes antidé-
pantes





Bambus –
Naturprodukt aus
nachwachsendem
Plantagenanbau
Angenehm
leichte Fußmassage
durch einzelne
Holzglieder der
Bambusmatte.
Mit rutschhemmenden
Moosgummistreifen

Bamboo – a natural product
harvested from renewable
plantations
Pleasant and gentle foot
massage due to the individual
wooden elements of the
bamboo mat
With anti-slip foam rubber
strips

Bambou - produit naturel issu
de plantations renouvelables
Agréable Massage léger des
pieds par un individu Liens en
bois de la Tapis de bambou.
Avec des bandes antidéra-
pantes



202
Natur



301
Nussbraun



926
Schwarz

Bambus / Bamboo / Bambou



Für Fußbodenheizung geeignet
Suitable for underfloor heating
Approprié au chauffage de sol

Höhe (mm)
Height
Hauteur

5



9113 ... 324
ca. 50 x 70 cm

Die Holzmatten von Kleine Wolke sind besonders hygienisch: Feuchtigkeit zieht nicht ein, sondern verdunstet schnell von der Oberfläche. Reinigung ohne Waschmaschine – einfach absaugen, ausklopfen oder feucht abwischen.

The wooden mats from Kleine Wolke are particularly hygienic: No moisture is absorbed, but instead evaporates quickly from the surface. Clean without washing machine - simply vacuum, beat or wipe with a damp cloth.

Les tapis en latte de bois Kleine Wolke sont particulièrement hygiéniques : aucune infiltration de l'humidité, qui s'évapore rapidement à la surface de l'article. Ne pas laver en machine – passer tout simplement l'aspirateur, taper l'article ou l'essuyer à l'aide d'un chiffon humide.



Creativo
DESIGN
by Kleine Wolke

INDIVIDUALITÄT FÜR HÖCHSTE ANSPRÜCHE

Für Kunden mit besonderen Anforderungen in Bezug auf Größe oder Design ihres Badteppichs bieten wir mit dem Creativo-Programm vielfältige Lösungen. Die Modelle lassen sich problemlos an bauliche Gegebenheiten, komplizierte Raumaufteilungen oder ausgeklügelte Farbkonzepte anpassen. Von Abmessung und Form bis hin zu Design und Farbe erfüllen Creativo Badteppiche sämtliche Gestaltungswünsche. Jedes Modell ist ein handgefertigtes Unikat – erstellt von qualifiziertem Fachpersonal.

INDIVIDUALITY THAT MEETS THE HIGHEST STANDARDS

Customers with special requirements with respect to the size or design of their bathroom rug can choose from a wide range of solutions in our Creativo line. The models can easily be tailored to the structure, complex floor plans or elaborate colour schemes. From dimensions and shape all the way to design and colour, Creativo bathroom rugs will fulfil your design preferences. Each model is handmade and unique – made by qualified professionals.

L'INDIVIDUALITE POUR LES PLUS HAUTES EXIGENCES

Avec la gamme Creativo, nous proposons de nombreuses solutions aux clients ayant des exigences particulières en termes de dimensions ou de design de leur tapis de bain. Les modèles s'adaptent facilement aux conditions de construction, aux agencements compliqués ou aux concepts de couleurs sophistiqués. De la dimension et de la forme au design et à la couleur, les tapis de bain Creativo répondent à tous les souhaits de conception. Chaque modèle est unique et fait à la main – la fabrication est réalisée par un personnel qualifié.

DIE VORTEILE DER CREATIVO BADTEPPICHE VON KLEINE WOLKE

THE ADVANTAGES OF CREATIVO AT A GLANCE / APERÇU DES AVANTAGES CREATIVO

- Individuelle Größen und Farben
- Eigene Wunsch-Designs für das Maximum an Individualität
- Exklusive Kollektions-Designs
- In Handarbeit durch qualifiziertes Fachpersonal gefertigt
- Auswahl aus mehr als 100 Farben
- Hochwertige, edle Garne und angenehmer Flor
- Langjährige Erfahrung bei der Umsetzung individueller Wünsche
- Höchster Qualitätsstandard mit OEKOTEX Zertifikat
- Lieferzeit von ca. 5 Wochen

- Custom sizes and colours
- Custom designs for the maximum in individuality
- Exclusive collection designs
- Handmade by qualified professionals
- Over 100 colour options
- Premium, elegant yarns and comfortable pile
- Years of experience in implementing customisations
- Highest quality standard with OEKOTEX certificate
- Lead time approx. 5 weeks

- Dimensions et couleurs personnalisées
- Des designs personnalisés pour un maximum d'individualité
- Designs exclusifs des collections
- Fabriqué à la main par des professionnels qualifiés
- Choix parmi plus de 100 couleurs
- Fils nobles de haute qualité et velours agréable
- Une longue expérience dans la réalisation de souhaits individuels
- Le plus haut niveau de qualité avec certification OEKOTEX
- Délai de livraison d'env. 5 semaines



ÜBERSICHT UNIFARBENE MODELLE

Content – Solid coloured models
Contenu – Modèles unis



RELAX

112-113



GRANDEZZA

114-115

CREATIVO DESIGN MODELLE

Creativo Design Models
Modèles Creativo Design



ANGELO

116



ARCATÀ

117



CASSETTA

118



CENTRO

119



COLLINA

120



EMOZIONE

121



HARMONIA

122



INTERNO

123

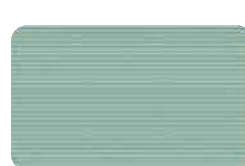

LINEA

124



MEANDRO

125



MESSAGGIO

126-127



NOVERO

128



VALLETTA

129

IN WENIGEN SCHRITTEN ZUM INDIVIDUELLEN WUNSCHTEPPICH

YOUR CHOSEN CUSTOMISED BATHMAT IN A FEW STEPS
LE TAPIS DE BAIN IDÉAL EN QUELQUES ÉTAPES

Wählen Sie das Maß und die gewünschte Form (rechteckig, quadratisch, rund, oval oder eine freie Form anhand einer Schablone des Badteppichs:

Choose a bathroom rug size and desired shape (rectangular, square, round, oval or free form using a template):

Choisissez la dimension et la forme souhaitée (rectangulaire, carrée, ronde, ovale ou une forme libre à partir d'un gabarit du tapis de bain:

a) Sondermaße für die Uni-Modelle GRANDEZZA und RELAX sind erhältlich von 20 x 20 cm bis zu 150 x 350 cm.

GRANDEZZA and RELAX in solid colours available in special sizes from 20 x 20 cm to 150 x 350 cm.

Des dimensions spéciales pour les modèles unis GRANDEZZA et RELAX sont disponibles de 20 x 20 cm à 150 x 350 cm.

b) Sondermaße für die Creativo Design Badteppiche sind erhältlich von 50 x 50 cm bis zu 150 x 350 cm.

Creativo Design bathroom rugs available in special sizes from 50 x 50 cm to 150 x 350 cm.

Des dimensions spéciales pour les tapis de bain Creativo Design sont disponibles de 50 x 50 cm à 150 x 350 cm.

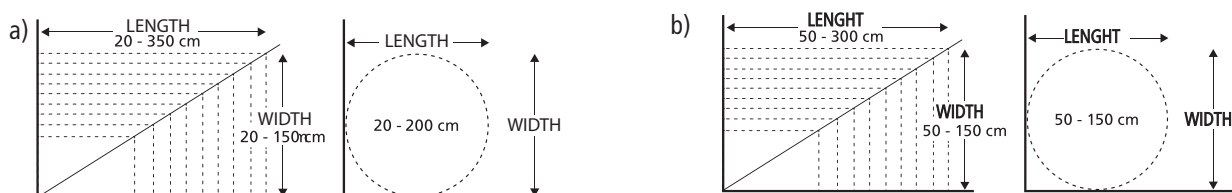

c) Entscheiden Sie sich für eine der vielen beliebten Größen und Formen.

Choose one of the many popular sizes and shapes.

Optez pour l'une des nombreuses dimensions et formes populaires.

2 Wählen Sie das Modell bzw. Design:

- Uni-Badteppich: GRANDEZZA, RELAX (Seite 106-109)
- Creativo Design Badteppich (ab Seite 110)
- Eigendesign (siehe Punkt 5)

Choose the model or design:

- Solid bathroom rug: GRANDEZZA, RELAX (page 106-109)
- Creativo Design bathroom rug (from page 110)
- Custom design (See bullet point 5)

Sélectionnez le modèle ou le design :

- Tapis de bain uni: GRANDEZZA, RELAX (pages 106-109)
- Tapis de bain Creativo Design (à partir de la page 110)
- Design propre (voir point d'énumération 5)

3 Wählen Sie die Farben:

- GRANDEZZA aus über 100 Farben
- RELAX aus 18 verschiedenen Melange-Farben
- Creativo Design Badteppiche
 - aus den beliebtesten Kolorits
 - bei individuellen Farbwünschen bestimmt Ihre Kunde pro Farbfeld seine Lieblingsfarben

Choose the colours:

- GRANDEZZA from over 100 colours
- RELAX from 18 different melange colours
- Creativo Design bathroom rugs
 - from the most popular colourings
 - for custom colours the customer determines their favourite colours for each colour field

Sélectionnez les couleurs :

- GRANDEZZA dans plus de 100 couleurs
- RELAX dans 18 couleurs chinées
- Tapis de bain Creativo Design
 - dans les coloris les plus populaires
 - pour les demandes de couleurs individuelles, votre client détermine ses couleurs préférées par champ de couleur

4 Beim Modell GRANDEZZA können Ihre Kunden zwischen 15mm, 20mm, 25mm, 30mm Florhöhen wählen.

With GRANDEZZA, your customers can choose from 15 mm, 20 mm, 25 mm, 30 mm piles.

With GRANDEZZA, your customers can choose from 15 mm, 20 mm, 25 mm, 30 mm piles.

5 Eigendesign – Wenn Ihr Kunde ein eigenes Design bzw. ein eigenes Motiv wünscht, prüfen wir gerne die Umsetzbarkeit. Wichtig hierbei ist, dass nur Motive aus flächigen Partien umsetzbar sind, keine fotorealistischen Motive. Für die Badteppiche werden die einzelnen Felder in jeweils einer Farbe getuftet, mehrere Felder in unterschiedlichen Farben ergeben in Summe das Motiv.

Custom design – if your customer would like to have their own custom design or motif, we will be happy to check if it is feasible. It's important to note only motifs from two-dimensional sections can be implemented, no photo-realistic designs. For bathroom rugs, the individual sections are tufted in one colour, several fields in different colours then yield the motif.

Personnalisation – Si votre client souhaite un design ou un motif personnalisé, nous nous ferons un plaisir d'en étudier la faisabilité. Il est important de noter que seuls des motifs composés de parties de grande surface sont réalisables. Les motifs photo-réalistes ne sont pas possibles. Pour les tapis de bain, chaque partie est touffetée dans une seule couleur, plusieurs champs de différentes couleurs s'additionnent pour former le motif.

MIT DER SCHABLONENFERTIGUNG WERDEN SIE ZUM EIGENEN DESIGNER

BECOME YOUR OWN DESIGNER WITH TEMPLATE PRODUCTION
DEVENEZ DESIGNER EN FABRIQUANT VOS PATRONS

TIPPS FÜR DIE ERSTELLUNG EINER SCHABLONE:

- Der Kunde sollte ein festes Papier in ausreichender Größe bereitlegen. Bei besonders großen Formaten können auch mehrere Stücke aneinander geklebt werden.
- Der Kunde zeichnet die äußere Kontur des Badteppichs auf das Papier.
- Nun wird die Schablone entlang der Kontur zugeschnitten. Anschließend kann der Kunde prüfen ob die Schablone passt.
- Wenn der Badteppich ein eigenes Design haben soll, zeichnet der Kunde dieses Design oder Muster direkt auf die Schablone. Die Farbflächen müssen als Farbfelder mit klarer Kontur erkennbar sein.
- Der Kunde füllt jedes Farbfeld mit der gewünschten Farbnummer unserer Farbpalette (siehe S. 104-105) aus.
- Für Schablonen-Badteppiche ist nur eine Florhöhe von 25 mm möglich.

TIPS FOR MAKING A TEMPLATE:

- The customer should provide firm paper in an adequate size. For particularly large sizes, several pieces can be bonded together.
- The customer draws the outer contour of the bathroom rug onto paper.
- The template is then cut along the contour. The customer can then verify the template fits.
- If the bathroom rug is to have a custom design, the customer draws this design or pattern directly onto the template. The colour fields must be identifiable as colour fields with clear contour.
- The customer fills each colour field with the desired colour code from our colour palette (see p. 104-105).
- Bathroom rugs based on a template only available with 25 mm pile.



CONSEILS POUR LA CRÉATION D'UN GABARIT:

- Le client doit préparer un papier rigide de taille suffisante. Pour les formats particulièrement grands, il est possible de coller plusieurs morceaux les uns aux autres.
- Le client dessine le contour extérieur du tapis de bain sur le papier.
- Le gabarit est ensuite découpé le long du contour. Le client peut ensuite vérifier si le gabarit lui convient.
- Si le tapis de bain doit avoir son propre design, le client dessine ce design ou ce motif directement sur le gabarit. Les surfaces colorées doivent être reconnaissables en tant que champs de couleur aux contours clairs.
- Le client remplit chaque champ de couleur avec le numéro de couleur souhaité de notre palette de couleurs (voir p. 104-105).
- Pour les tapis de bain sur gabarit, seule une hauteur de poil de 25 mm est possible.



SCHRITTE VON DER SCHABLONE BIS ZUM FERTIGEN BADTEPPICH UNIKAT:

- Senden Sie die Schablone Ihres Kunden an Kleine Wolke.
- Wir prüfen noch einmal den Zuschnitt, die Umsetzbarkeit, und berechnen den Preis.
- Sollte es Rückfragen geben, nehmen wir Kontakt zu Ihnen auf. Klären Sie diese Fragen ggf. mit Ihrem Kunden.
- Die Schablone wird von uns digitalisiert und an die Produktion weitergeleitet, die den Badteppich in der gewünschten Form und Farbe herstellt.
- Der fertige Badteppich wird an Sie ausgeliefert. Die Lieferzeit bei Schablonenfertigung beträgt ca. 6 Wochen.
- Art. Nr. 7446 (Preis auf Anfrage)

STEPS FROM THE TEMPLATE TO THE FINISHED UNIQUE BATHROOM RUG:

- Send your customer's template to Kleine Wolke.
- We will review the cut-out, whether it is feasible, and calculate the price.
- If we have any questions we will contact you. If necessary, contact the customer for clarification.
- We digitise the template and forward it to production, which then produces the bathroom rug in the desired shape and colour.
- The finished bathroom rug is then delivered to you. The lead time for template-based production is about 6 weeks.
- Item no. 7446 (price on request)

LES ÉTAPES DE LA CRÉATION D'UN TAPIS DE BAIN UNIQUE À PARTIR D'UN GABARIT:

- Envoyez le gabarit de votre client à Kleine Wolke.
- Nous vérifierons à nouveau la découpe, la faisabilité, et calculons le prix.
- Si vous avez des questions, nous vous contacterons. Si nécessaire, clarifiez ces questions avec votre client.
- Nous numérisons le gabarit et le transmettons à la production, qui fabrique le tapis de bain dans la forme et la couleur souhaitées.
- Le tapis de bain fini vous est livré. Le délai de livraison pour la fabrication de gabarits est d'env. 6 semaines.
- Réf. 7446 (prix sur demande)

BERECHNUNGSBEISPIELE FÜR WUNSCHMASS

CALCULATION EXAMPLES FOR CUSTOM DIMENSIONS

EXEMPLES DE FACTURATION POUR LES DIMENSIONS DE VOTRE CHOIX

Hat Ihr Kunde ein individuelles Maß für seinen Wunsch Badteppich gewählt und nicht eine der beliebten Größen und Formen, errechnet sich die unverbindliche Preisempfehlung (UVP) über den Quadratmeterpreis.

If you have chosen customised dimensions for your model, our non-binding price recommendation (RRP) is calculated using the price per square metre.

Si vous avez sélectionné une taille personnalisée pour votre modèle, notre prix de vente conseillé (PVC) se calcule en fonction du prix au mètre carré.

Beispiel für einen Quadratmeterpreis von 299,99 €:

Example for a price per square metre of 299,99 €:

Exemple pour un prix au mètre carré de 299,99 €:

RECHTECKIGE FORM / RECTANGULAR / FORME RECTANGULAIRE

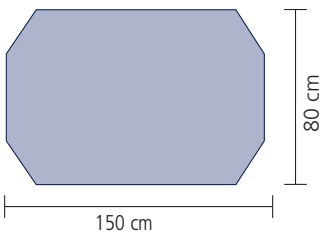

Breite x Länge = zu berechnende Fläche

$$0,8 \text{ m} \times 1,5 \text{ m} = 1,2 \text{ qm}$$
$$299,99 \text{ €} \times 1,2 \text{ qm} = 359,99 \text{ €}$$

width x length = area to be calculated

$$0,8 \text{ m} \times 1,5 \text{ m} = 1,2 \text{ qm}$$
$$299,99 \text{ €} \times 1,2 \text{ qm} = 359,99 \text{ €}$$

largeur x longueur = superficie à calculer

$$0,8 \text{ m} \times 1,5 \text{ m} = 1,2 \text{ qm}$$
$$299,99 \text{ €} \times 1,2 \text{ qm} = 359,99 \text{ €}$$

OVALE FORM / OVAL / FORME OVALE

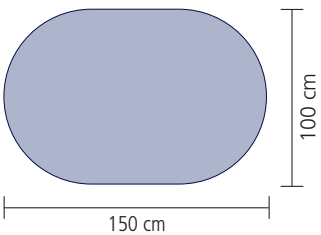

Breite x Länge = zu berechnende Fläche

$$1,0 \text{ m} \times 1,5 \text{ m} = 1,5 \text{ qm}$$
$$299,99 \text{ €} \times 1,5 \text{ qm} = 449,99 \text{ €}$$

width x length = area to be calculated

$$1,0 \text{ m} \times 1,5 \text{ m} = 1,5 \text{ qm}$$
$$299,99 \text{ €} \times 1,5 \text{ qm} = 449,99 \text{ €}$$

largeur x longueur = superficie à calculer

$$1,0 \text{ m} \times 1,5 \text{ m} = 1,5 \text{ qm}$$
$$299,99 \text{ €} \times 1,5 \text{ qm} = 449,99 \text{ €}$$

RUNDE FORM / ROUND / FORME RONDE

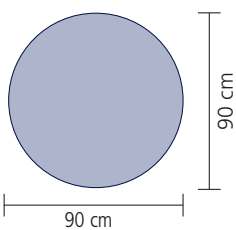

Breite x Länge = zu berechnende Fläche

$$0,9 \text{ m} \times 0,9 \text{ m} = 0,81 \text{ qm}$$
$$299,99 \text{ €} \times 0,81 \text{ qm} = 242,99 \text{ €}$$

width x length = area to be calculated

$$0,9 \text{ m} \times 0,9 \text{ m} = 0,81 \text{ qm}$$
$$299,99 \text{ €} \times 0,81 \text{ qm} = 242,99 \text{ €}$$

largeur x longueur = superficie à calculer

$$0,9 \text{ m} \times 0,9 \text{ m} = 0,81 \text{ qm}$$
$$299,99 \text{ €} \times 0,81 \text{ qm} = 242,99 \text{ €}$$

SO BESTELLEN SIE RICHTIG – BESTELLFORMULAR

HOW TO ORDER – ORDER FORM

VOICI COMMENT PASSER CORRECTEMENT COMMANDE – FORMULAIRE DE COMMANDE

1 AUSWAHL VON FORM UND GRÖSSE

In diesem Bereich sind die beliebtesten Formen und Größen des Models aufgeführt, mit den jeweiligen unverbindlichen Preisempfehlungen.

Unsere unverbindliche Preisempfehlung sieht für beliebte Größen und Formen niedrigere Preise vor als für ein frei zu wählendes Wunschmaß.

Diese entnehmen Sie dem Bestellformular für das jeweilige Modell.

Unsere unverbindliche Preisempfehlung sieht für beliebte Größen und Formen niedrigere Preise vor als für ein frei zu wählendes Wunschmaß. Diese entnehmen Sie dem Bestellformular für das jeweilige Modell.

SELECT THE SHAPE AND SIZE

This area shows the most popular shapes and sizes of the model along with the respective suggested retail prices.

Our suggested retail prices are lower for popular sizes and shapes than for custom sizes.

Please refer to the order form for the respective model.

Our suggested retail prices are lower for popular sizes and shapes than for custom sizes. please refer to the order form for the respective model.

CHOIX DE LA FORME ET DE LA TAILLE

Cette section présente les formes et les tailles les plus populaires du modèle, avec les prix de vente conseillés correspondants.

Nos prix de vente conseillés prévoient des prix plus bas pour les tailles et les formes populaires que pour une dimension souhaitée à choisir librement.

Pour les connaître, consultez le bon de commande de chaque modèle.

Nos prix de vente conseillés prévoient des prix plus bas pour les tailles et les formes populaires que pour une dimension souhaitée à choisir librement. Pour les connaître, consultez le bon de commande de chaque modèle.

2 AUSWAHL VON INDIVIDUELLEN WUNSCHGRÖSSEN

Wenn Ihr Kunde ein individuelles Wunschmaß wünscht, tragen Sie dies bitte darunter in die dafür vorgesehenen Felder ein.

SELECTING CUSTOM SIZES

If your customer is requesting a custom size, please enter the size below in the designated field.

SELECTION DE DIMENSIONS PERSONNALISEES

Si votre client souhaite une mesure personnalisée, veuillez l'indiquer ci-dessous dans les champs prévus à cet effet.

3 AUSWAHL FLORHÖHE

Beim Modell GRANDEZZA gibt es die Möglichkeit, die gewünschte Florhöhe von 15mm, 20mm, 25mm oder 30mm einzutragen. Bei allen anderen Modellen geben wir die ideale Florhöhe bereits vor.

SELECT PILE

For GRANDEZZA, you can enter a 15 mm, 20 mm, 25 mm or 30 mm pile. For all other models we specify the ideal pile.

SÉLECTION DE LA HAUTEUR DE POIL

Pour le modèle GRANDEZZA, il est possible de saisir la hauteur de poils souhaitée de 15 mm, 20 mm, 25 mm ou 30 mm. Pour tous les autres modèles, nous indiquons déjà la hauteur de poil idéale.

4 AUSWAHL AUS BELIEBTEN FARBEN ODER WUNSCHFARBEN

Im unteren Bereich tragen Sie bitte die Wunschfarbe Ihres Kunden ein. Bei einem Uni-Modell ist dies eine Farbnummer aus der Farbpalette. Bei den Creativo Design Teppichen tragen Sie eines der vorgegebenen Kolorits ein. Wenn der Kunde die Farben selber auswählen möchte, muss jedes Farbfeld mit der gewünschten Farbnummer ausgefüllt werden.

SELECTION OF POPULAR COLOURS OR CUSTOM COLOURS

At the bottom, please enter the customer's preferred colour. For solid colour models, this is a colour code from the colour pallet. For Creativo Design rugs, enter one of the specified colourings. If the customer wishes to choose their own colour, enter the desired colour code in each colour field.

CHOIX DE COULEURS POPULAIRES OU DE COULEURS SOUHAITÉES

Dans la partie inférieure, veuillez indiquer la couleur souhaitée par votre client. Pour un modèle uni, il s'agit d'un numéro de couleur de la palette de couleurs. Pour les tapis Creativo Design, vous devez inscrire l'une des couleurs prédéfinies. Si le client souhaite choisir lui-même les couleurs, chaque champ de couleur doit être rempli avec le numéro de couleur souhaité.

Bestellformular für Modell "GRANDEZZA"

Kategorie:

Modell:

Farbe:

Produkt:

Bestellinformationen

Bestellnummer		Bestelltag	
Name / Firma		Bestellort	
Strasse		Postleitzahl	
PLZ, Ort		PLZ, Ort	

Wählen Sie Ihre gewünschte Form und Größe:

Rechteck	Rechteck hoch	Rechteck breit	Rechteck hoch	Rechteck breit
150x200 cm	150x250 cm	150x300 cm	150x400 cm	150x500 cm
200x300 cm	200x400 cm	200x500 cm	200x600 cm	200x800 cm
250x350 cm	250x450 cm	250x550 cm	250x650 cm	250x850 cm
300x400 cm	300x500 cm	300x600 cm	300x700 cm	300x900 cm
350x450 cm	350x550 cm	350x650 cm	350x750 cm	350x850 cm

Bestimmen Sie Ihren Deckflächenwert:

Deckfläche	150x200 cm	150x250 cm	150x300 cm	150x400 cm	150x500 cm
Deckfläche	200x300 cm	200x400 cm	200x500 cm	200x600 cm	200x800 cm
Deckfläche	250x350 cm	250x450 cm	250x550 cm	250x650 cm	250x850 cm
Deckfläche	300x400 cm	300x500 cm	300x600 cm	300x700 cm	300x900 cm
Deckfläche	350x450 cm	350x550 cm	350x650 cm	350x750 cm	350x850 cm

Oder wählen Sie Ihre Wunschgröße (Hersteller - cm):

Wählen Sie Ihre Wunschgröße (Hersteller - cm):	Wählen Sie Ihre Wunschgröße (Hersteller - cm):	Wählen Sie Ihre Wunschgröße (Hersteller - cm):
Wählen Sie Ihre Wunschgröße (Hersteller - cm):	Wählen Sie Ihre Wunschgröße (Hersteller - cm):	Wählen Sie Ihre Wunschgröße (Hersteller - cm):

Wählen Sie Ihre gewünschte Farbe:

Wählen Sie Ihre gewünschte Farbe:	Wählen Sie Ihre gewünschte Farbe:	Wählen Sie Ihre gewünschte Farbe:
Wählen Sie Ihre gewünschte Farbe:	Wählen Sie Ihre gewünschte Farbe:	Wählen Sie Ihre gewünschte Farbe:

© 2018 Creativo Design. Alle Rechte vorbehalten. Dieses Dokument ist ein Eigentum von Creativo Design. Die Weitergabe oder Kopie dieses Dokuments ist ohne schriftliche Genehmigung von Creativo Design ist ausdrücklich untersagt. Die Haftung für die Richtigkeit der Angaben ist nicht übernommen. Die Haftung für die Richtigkeit der Angaben ist nicht übernommen. Die Haftung für die Richtigkeit der Angaben ist nicht übernommen.

FARBÜBERSICHT

COLOUR OVERVIEW
Aperçu DES COULEURS

Über 100 Farben stehen Ihnen für die Gestaltung unserer CREATIVO DESIGN KOLLEKTION zur Verfügung.

Over 100 colours are available for use in the design of our CREATIVO DESIGN COLLECTION.

Plus de 100 couleurs vous sont proposées pour la création de notre COLLECTION CREATIVO DESIGN.

100 Weiß	553 Mimose	443 Magnolie	607 Salbeigrün
220 Champagner	573 Canari	442 Flamingo	672 Türkis
203 Korn	569 Goldgelb	472 Malve	675 Petrol
217 Berberbeige	568 Sunshine	401 Nelke	685 Maledivia
226 Sandbeige	539 Safran	413 Pastellrose	698 Eucalyptus
291 Bast	370 Sandelholz	457 Hellrosa	766 Türkis
266 Ingwer	319 Aprikose	407 Old Rose	663 Pazifik
264 Walnuss	322 Pfirsich	431 Rouge	738 Hellblau
289 Seide	316 Rost	436 Beere	723 Azur
272 Macadamia	331 Karotte	415 Koralle	720 Blau
271 Taupe	333 Brandy	437 Geranie	769 Marineblau
287 Kaschmir	334 Chili	428 Bordeaux	712 Sorr.-Azurblau
224 Toffee	398 Pearl	451 Weinrot	736 Atlantikblau
231 Bambusbeige	397 Papaya	438 Melone	789 Dunkelblau
342 Brasil	396 Lachs	453 Rubin	791 Himmelblau
311 Mahagoni	115 Polarweiß	468 Granat	798 Königsblau
301 Nussbraun	926 Schwarz	460 Cyclam	799 Royalblau
304 Terracotta		461 Purple	746 Stahlblau
325 Siena			754 Iceblue
327 Marsala			783 Mare
332 Rosenholz			812 Holunder
			892 Pflaume
			872 Aubergine

100% Polyacryl



FARBÜBERSICHT

COLOUR OVERVIEW
Aperçu DES COULEURS

158 Auster

151 Kiesel

146 Silbergrau

179 Flanell

189 Grau

913 Nebel

977 Platin

901 Anthrazit

905 Schiefer

689 Zeder

605 Alge

603 Palme

602 Klee

601 Moosshellgrün

635 Farn

619 Linde

617 Distel

630 Pistazie

633 Minze

657 Tanne

625 Maigrün

615 Kiwigrün

616 Dill

612 Forest

Farbmusterstreifen mit den Creativo-Design Polyacryl-Farben

Colour sample strips showing the Creativo Design polyacrylic colours.

Échantillons disponibles dans les couleurs de polyacrylique Creativo Design.



Bestellbar mit folgenden Artikelnummern:

- 1) 0004 097 000
- 2) 0004 098 000
- 3) 0004 099 000
- 4) 0004 100 000
- 5) 0004 101 000

RELAX

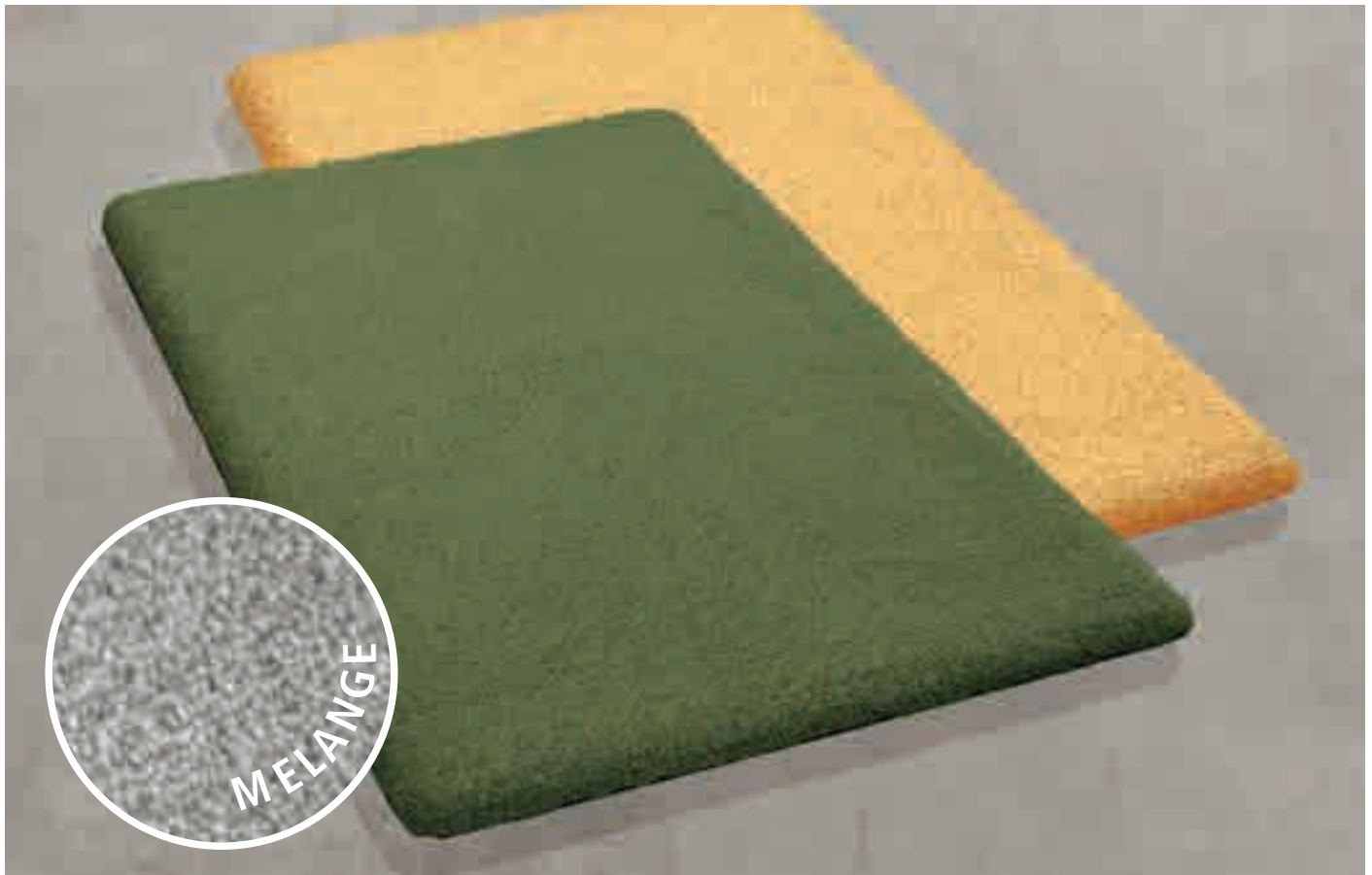

WOHLFÜHLWEICH UND ZEITLOS ELEGANT.

Das Modell RELAX überzeugt im besonderen durch die außergewöhnliche Melange-Optik. 18 mögliche Farben* stehen zur Verfügung. Sehr edel und mit 30 mm Florhöhe sehr hochwertig, verschönert dieses Modell jedes Bad.

SOFT & COSY WITH TIMELESS ELEGANCE.

The RELAX model is particularly appreciated by customers thanks to its unusual blended look. 18 possible colour blends* are available to choose from. Very sophisticated and – with a 30 mm pile height – very high-quality, this model improves the look of any bathroom.

L'INDIVIDUALITE POUR LES PLUS HAUTES EXIGENCES UNE DOUCEUR AGREABLE ET UNE ÉLÈGANCE INTEMPORELLE.

Le modèle RELAX se distingue grâce à son apparence chinée si exceptionnelle. 18 couleurs chinées* sont disponibles. Très élégant, et d'une qualité supérieure grâce à sa hauteur de fibres de 30 mm, ce modèle saura mettre chaque salle de bain en valeur.

Folgende Farben stehen Ihnen für unser Modell RELAX zur Verfügung.

The following colour blends are available for our RELAX model.

Les couleurs chinées suivantes sont disponibles pour notre modèle RELAX.

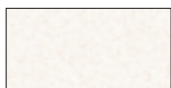

* 115 Polarweiß



189 Grau



220 Champagner



226 Sandbeige



271 Taupe



316 Rost



453 Rubin



553 Mimose



612 Forest



615 Kiwigrün



663 Pazifik



672 Türkis



685 Maledivia



723 Azur



736 Atlantikblau



901 Anthrazit



* 926 Schwarz

* 115 Polarweiß + 926 Schwarz *nicht meliert / not flecked / non chiné

Ihr gewohntes RELAX-Sortiment sowie Deckelbezug finden Sie auf den Seiten 13.



Find the standard RELAX product range as well as toilet lid covers on pages 13.

Retrouvez l'assortiment RELAX habituel, ainsi que les housses d'abattant aux pages 13.

BELIEBTE GRÖSSEN UND FORMEN

POPULAR SIZES AND SHAPES

TAILLES ET FORMES POPULAIRES

Beliebte Größen (cm) Popular sizes (cm) Tailles populaires (cm)	Größen-schlüssel Size code Code des tailles	7431 ... Viereck Square Carré spitze Ecken pointed corners coins pointus	7432 ... Achteck Octagonal Octogonal	7433 ... Oval Oval Ovale
				
55 x 55 m.A.	129	●	●	●
55 x 65	539	●	●	●
55 x 85	270	●	●	●
60 x 100	360	●	●	●
70 x 120	311	●	●	●
80 x 150	317	●	●	●
80 x 80	290	●	●	
100 x 100	720	●	●	
120 x 120	728	●	●	

m.A. = mit Ausschnitt / with cutout / avec découpe

RELAX mit abgerundeten Ecken finden Sie auch in vielen Standard-Größen und den 17 Farben in der Kleine Wolke Kollektion auf Seite 13.

RELAX with rounded corners are also available in many standard sizes and the 17 colours in the Kleine Wolke collection on page 13.

Vous trouverez également RELAX avec des coins arrondis dans de nombreuses dimensions standard et dans les 17 couleurs de la collection Kleine Wolke à la page 13.



WUNSCHMASS CUSTOM DIMENSIONS DIMENSIONS SOUHAITÉES

Wählen Sie Ihr individuelles Wunschmaß von 20 x 20 cm bis zu 150 x 350 cm oder rund 20 - 200 cm.

Choose your customised dimensions from 20 x 20 cm up to 150 x 350 cm or 20 - 200 cm (round).

Sélectionnez vos dimensions personnalisées de 20 x 20 cm à 150 x 350 cm ou au format rond, de 20 à 200 cm.

qm (000)

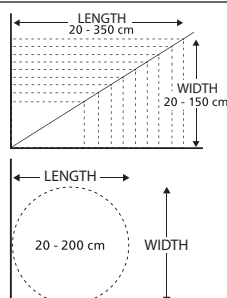

WUNSCHFARBEN CUSTOM COLOURS COULEURS SOUHAITÉES

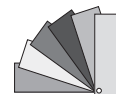

Wählen Sie aus den 17 Farben der RELAX-Farbpalette.

Choose from the 17 colours in the RELAX colour palette. Faites votre sélection parmi les 17 couleurs de la palette RELAX.



SCHABLONENFERTIGUNG TEMPLATE PRODUCTION FABRICATION D'UN PATRON

Sie benötigen eine außergewöhnliche Form? Gestalten Sie doch einfach Ihren persönlichen Badteppich ganz nach Ihren Bedürfnissen.

Do you require an unusual shape? You can still design your own customised bathmat entirely in line with your requirements.

Vous avez besoin d'une forme originale ? Créez tout simplement votre tapis de bain personnel, selon vos besoins.

7460 ... 999

Für Schablonenfertigung RELAX bitte ausschließlich die Artikel-Nummer 7460 benutzen.

For RELAX template production, please only use the item number 7460.

Pour fabriquer un patron RELAX, veuillez utiliser le numéro d'article 7460.

GRANDEZZA



WUNDERSCHÖN UND ÜBERZEUGEND KLASSISCH.

Mit dem Uni-Modell GRANDEZZA aus der CREATIVO DESIGN KOLLEKTION erwerben Sie ein besonders hochwertiges Produkt. Dieses Modell ist in den Florhöhen 15 mm, 20 mm, 25 mm oder 30 mm ohne Preisunterschied erhältlich. Wir empfehlen 25 mm für eine optimale Haptik und perfekten Stand des Polyacryl-Garns.

BEAUTIFUL AND IMPRESSIVELY CLASSIC.

With the unique GRANDEZZA model from the CREATIVO DESIGN COLLECTION you are purchasing a particularly high-quality product. This model is available in 15 mm, 20 mm, 25 mm or 30 mm piles for the same price. We recommend 25 mm for the optimal feel and perfect look of the acrylic yarn.

MAGNIFIQUE DANS UN STYLE CLASSIQUE CONVAINCANT.

Grâce au modèle unicolore GRANDEZZA issu de la COLLECTION CREATIVO DESIGN, vous faites l'acquisition. Ce modèle est disponible dans les hauteurs de poils 15 mm, 20 mm, 25 mm ou 30 mm sans différence de prix. Nous recommandons une hauteur de 25 mm pour une sensation au toucher optimale et une tenue parfaite du fil polyacrylique.

15

20





25

30

BELIEBTE GRÖSSEN UND FORMEN

POPULAR SIZES AND SHAPES

TAILLES ET FORMES POPULAIRES

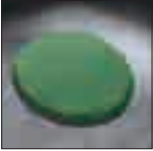
Beliebte Größen (cm) Popular sizes (cm) Tailles populaires (cm)	Größen-schlüssel Size code Code des tailles	8709 ... Viereck Square Carré spitze Ecken pointed corners coins pointus	8711 ... Viereck Square Carré abgerundete Ecken rounded corners coins arrondis	8710 ... Achteck Octagonal Octogonal	8712 ... Oval Oval Ovale	7435 ... Rund Round Rond
55 x 55 m.A.	129					
55 x 65	539	●	●	●	●	
55 x 85	270	●	●	●	●	
60 x 100	360	●	●	●	●	
70 x 120	311	●	●	●	●	
80 x 150	317	●	●	●	●	
80 x 80	290	●	●	●		
100 x 100	720	●	●	●		
120 x 120	728	●	●	●		
60 rund	307					●
80 rund	518					●
100 rund	521					●

m.A. = mit Anschnitt
with cutout
avec découpe



Deckelbezug
Lid cover / Housse
COPERTINA

7434 ... 104
ca. 47 x 50 cm

Florhöhe (mm)
Pile height
Hauteur mèches

25



WUNSCHMASS CUSTOM DIMENSIONS DIMENSIONS SOUHAITÉES

Wählen Sie Ihr individuelles Wunschmaß von 20 x 20 cm bis zu 150 x 350 cm oder rund 20 - 200 cm.

Choose your customised dimensions from 20 x 20 cm up to 150 x 350 cm or 20 - 200 cm (round).
Sélectionnez vos dimensions personnalisées de 20 x 20 cm à 150 x 350 cm ou au format rond, de 20 à 200 cm.

qm (000)

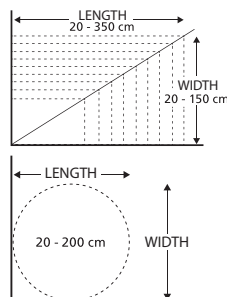

WUNSCHFARBEN CUSTOM COLOURS COULEURS SOUHAITÉES

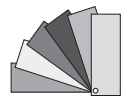

Wählen Sie aus über 100 Farben der CREATIVO-Farbpalette.

Choose from over 100 colours in the CREATIVO colour palette.
Choisissez parmi plus de 100 couleurs la palette de couleurs CREATIVO.



SCHABLONENFERTIGUNG TEMPLATE PRODUCTION FABRICATION D'UN PATRON

Sie benötigen eine außergewöhnliche Form? Gestalten Sie doch einfach Ihren persönlichen Badteppich ganz nach Ihren Bedürfnissen.

Do you require an unusual shape? You can still design your own customised bathmat entirely in line with your requirements.
Vous avez besoin d'une forme originale? Créez tout simplement votre tapis de bain personnel, selon vos besoins.

7458 ... 999

Für Schablonenfertigung GRANDEZZA bitte ausschließlich die Artikel-Nummer 7458 benutzen.

For GRANDEZZA template production, please only use the item number 7458.
Pour fabriquer un patron GRANDEZZA, veuillez utiliser le numéro d'article 7458.

 100% Polyacryl

ANGELO

100% Polyacryl



Florhöhe (mm)

Pile height
Hauteur mèches



Deckelbezug (mm)

Lid cover
Housse

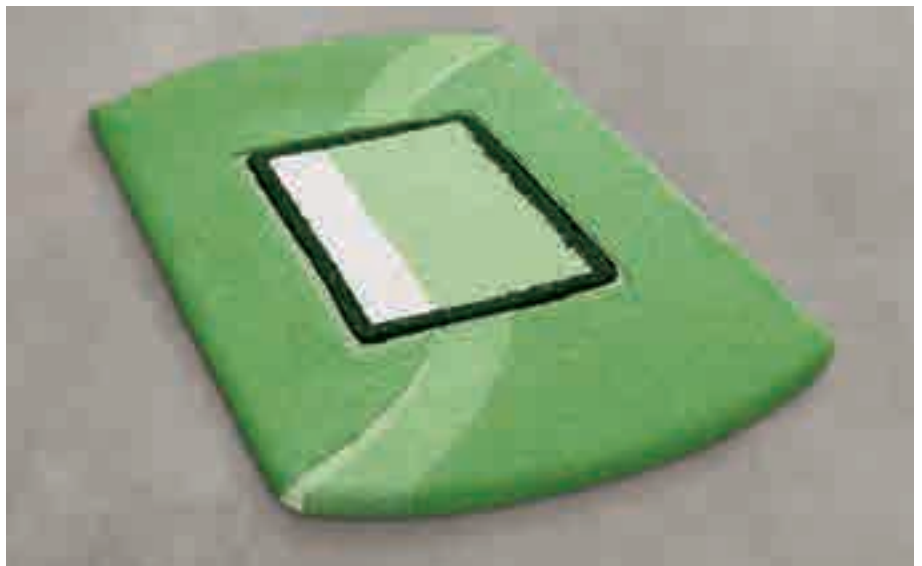

BELIEBTE GRÖSSEN UND FORMEN / POPULAR SIZES AND SHAPES / TAILLES ET FORMES POPULAIRES



8815 ... 129
ca. 55 x 55 cm



8815 ... 539
ca. 55 x 65 cm



8815 ... 270
ca. 55 x 85 cm

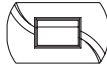

8815 ... 360
ca. 60 x 100 cm

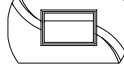

8815 ... 311
ca. 70 x 120 cm

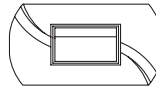

8815 ... 317
ca. 80 x 150 cm



8815 ... 290
ca. 80 x 80 cm

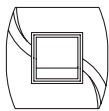

8815 ... 720
ca. 100 x 100 cm

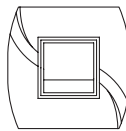

8815 ... 728
ca. 120 x 120 cm



8815 ... 307
ca. 60 cm rund



8815 ... 518
ca. 80 cm rund

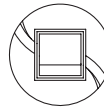

8815 ... 521
ca. 100 cm rund



Deckelbezug / Lid cover/ Housse
COPERTINA
7434 ... 104
ca. 47 x 50 cm

WUNSCHGRÖSSEN / CUSTOM SIZES / TAILLES SOUHAITÉES



Wählen Sie Ihr individuelles Wunschmaß von 50 x 50 cm bis zu 150 x 300 cm oder rund 50 - 150 cm. Extreme Maße können ggf. zu Verzerrungen führen.

Choose your customised dimensions from 50 x 50 cm up to 150 x 300 cm or 50 - 150 cm (round). Extreme sizes may result in distortions.
Sélectionnez vos dimensions personnalisées, de 50 x 50 cm à 150 x 300 cm, ou de forme ronde de 50 à 150 cm. Des dimensions extrêmes peuvent éventuellement entraîner une distorsion du motif.

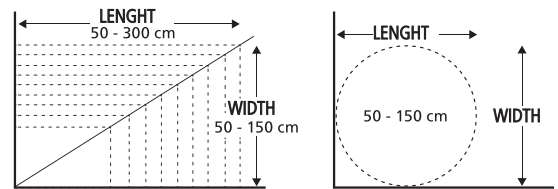

Größen Nr. / Sizes no. / Dimensions n°
Rechteckig / Square / Rectangulaire
Rund / Round / Rond
WC-Vorleger / Contoured rug / Contour WC

qm (000)
qm (093)
qm (092)

BELIEBTE FARBEN / POPULAR COLOURS / COULEURS POPULAIRES



189 Grau



203 Korn



271 Taupe



316 Rost



453 Rubin



568 Sunshine



617 Distel



720 Blau

WUNSCHFARBEN CUSTOM COLOURS / COULEURS SOUHAITÉES

Stellen Sie Ihre eigene Farbkombination zusammen. Eine Farbübersicht finden Sie auf den Seiten 100 / 101. Das Motiv der Creativo Designs ist als Farbfelder mit einer Zahl gekennzeichnet. Gleiche Zahl bedeutet, dass alle Felder mit dieser Zahl die gleiche Farbe haben.

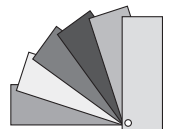

Put together your own colour combination. You can find a colour overview on pages 100 / 101. The Creativo Design motif is marked as colour fields with a number. The same number means all fields with this number will be the same colour.

Composez la combinaison de couleurs de votre choix. Retrouvez l'aperçu des couleurs aux pages 100 / 101. Le motif des Creativo Designs est symbolisé par des cases de couleur avec un chiffre. Un chiffre identique signifie que toutes les cases contenant ce chiffre sont de la même couleur.

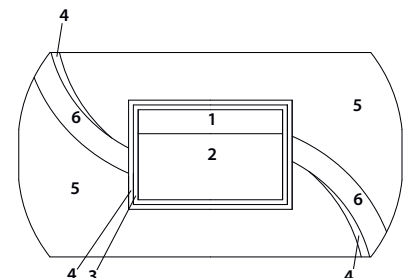

100% Polyacryl



Florhöhe (mm)

Pile height / Hauteur mèches 15 25

Deckelbezug (mm)

Lid cover / Housse 25



BELIEBTE GRÖSSEN UND FORMEN / POPULAR SIZES AND SHAPES / TAILLES ET FORMES POPULAIRES



7551 ... 129
ca. 55 x 55 cm



7551 ... 539
ca. 55 x 65 cm



7551 ... 270
ca. 55 x 85 cm

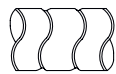

7551 ... 360
ca. 60 x 100 cm



7551 ... 225
ca. 70 x 120 cm



7551 ... 317
ca. 80 x 150 cm



7551 ... 290
ca. 80 x 80 cm



7551 ... 720
ca. 100 x 100 cm

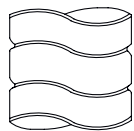

7551 ... 728
ca. 120 x 120 cm



7551 ... 307
ca. 60 cm rund



7551 ... 518
ca. 80 cm rund



7551 ... 521
ca. 100 cm rund



Deckelbezug / Lid cover / Housse
COPERTINA
7434 ... 104
ca. 47 x 50 cm

WUNSCHGRÖSSEN / CUSTOM SIZES / TAILLES SOUHAITÉES



Wählen Sie Ihr individuelles Wunschmaß von 50 x 50 cm bis zu 150 x 300 cm oder rund 50 - 150 cm. Extreme Maße können ggf. zu Verzerrungen führen.

Choose your customised dimensions from 50 x 50 cm up to 150 x 300 cm or 50 - 150 cm (round). Extreme sizes may result in distortions.

Sélectionnez vos dimensions personnalisées, de 50 x 50 cm à 150 x 300 cm, ou de forme ronde de 50 à 150 cm. Des dimensions extrêmes peuvent éventuellement entraîner une distorsion du motif.

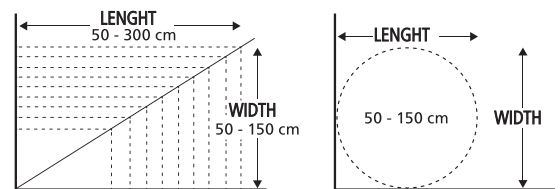

Größen Nr. / Sizes no. / Dimensions n°

Rechteckig / Square / Rectangulaire

Rund / Round / Rond

WC-Vorleger / Contoured rug / Contour WC

qm (000)

qm (093)

qm (092)

BELIEBTE FARBEN / POPULAR COLOURS / COULEURS POPULAIRES



158 Auster

226 Sandbeige

319 Aprikose



407 Old Rose

438 Melone

553 Mimose



603 Palme

723 Azur

WUNSCHFARBEN CUSTOM COLOURS / COULEURS SOUHAITÉES

Stellen Sie Ihre eigene Farbkombination zusammen. Eine Farbübersicht finden Sie auf den Seiten 100 / 101. Das Motiv der Creativo Designs ist als Farbfelder mit einer Zahl gekennzeichnet. Gleiche Zahl bedeutet, dass alle Felder mit dieser Zahl die gleiche Farbe haben.

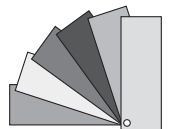

Put together your own colour combination. You can find a colour overview on pages 100 / 101. The Creativo Design motif is marked as colour fields with a number. The same number means all fields with this number will be the same colour.

Composez la combinaison de couleurs de votre choix. Retrouvez l'aperçu des couleurs aux pages 100 / 101. Le motif des Creativo Designs est symbolisé par des cases de couleur avec un chiffre. Un chiffre identique signifie que toutes les cases contenant ce chiffre sont de la même couleur.

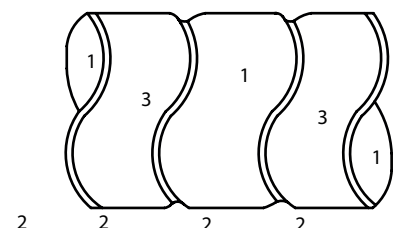

2

2

2

2

CASSETTA

100% Polyacryl



Florhöhe (mm)

Pile height
Hauteur mèches

25

Deckelbezug (mm)

Lid cover
Housse

25



BELIEBTE GRÖSSEN UND FORMEN / POPULAR SIZES AND SHAPES / TAILLES ET FORMES POPULAIRES



7397 ... 129
ca. 55 x 55 cm



7397 ... 539
ca. 55 x 65 cm



7397 ... 270
ca. 55 x 85 cm

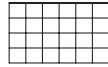

7397 ... 360
ca. 60 x 100 cm

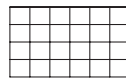

7397 ... 311
ca. 70 x 120 cm

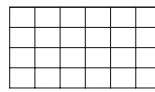

7397 ... 317
ca. 80 x 150 cm

Hinweis: Die Anzahl der Kästchen kann je nach Badteppich-Größe variieren.

Important note: The specific amount of boxes may vary, depending on the size of the bathmat.

Remarque: Le nombre de cases peut varier en fonction de la taille du tapis de bain.



7397 ... 290
ca. 80 x 80 cm

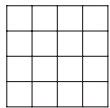

7397 ... 720
ca. 100 x 100 cm

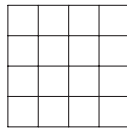

7397 ... 728
ca. 120 x 120 cm



7397 ... 307
ca. 60 cm rund



7397 ... 518
ca. 80 cm rund

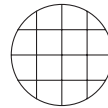

7397 ... 521
ca. 100 cm rund



Deckelbezug / Lid cover / Housse
COPERTINA
7434 ... 104
ca. 47 x 50 cm

WUNSCHGRÖSSEN / CUSTOM SIZES / TAILLES SOUHAITÉES



Wählen Sie Ihr individuelles Wunschmaß von 50 x 50 cm bis zu 150 x 300 cm oder rund 50 - 150 cm. Extreme Maße können ggf. zu Verzerrungen führen. Hinweis: Anzahl und Größe der Linien sind abhängig von der Größe des Badteppichs.

Choose your customised dimensions from 50 x 50 cm up to 150 x 300 cm or 50 - 150 cm (round). Note: The number and size of the lines depends on the size of the bath mat. Sélectionnez vos dimensions personnalisées, de 50 x 50 cm à 150 x 300 cm, ou de forme ronde de 50 à 150 cm. Remarque: Le nombre et la taille des lignes dépendent de la taille du tapis de bain.

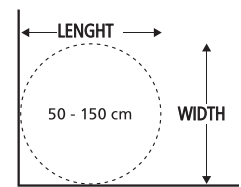
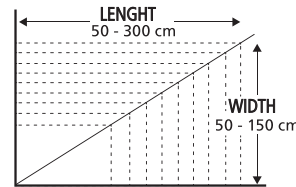

Größen Nr. / Sizes no. / Dimensions n°

Rechteckig / Square / Rectangulaire

Rund / Round / Rond

WC-Vorleger / Contoured rug / Contour WC

qm (000)

qm (093)

qm (092)

BELIEBTE FARBEN / POPULAR COLOURS / COULEURS POPULAIRES



217 Berberbeige



271 Taupe



453 Rubin



472 Malve



633 Minze



766 Türkis



769 Marineblau



905 Schiefer

WUNSCHFARBEN CUSTOM COLOURS / COULEURS SOUHAITÉES

Stellen Sie Ihre eigene Farbkombination zusammen. Eine Farbübersicht finden Sie auf den Seiten 100 / 101. Das Motiv der Creativo Designs ist als Farbfelder mit einer Zahl gekennzeichnet. Gleiche Zahl bedeutet, dass alle Felder mit dieser Zahl die gleiche Farbe haben.

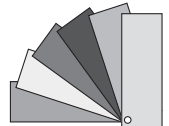

Put together your own colour combination. You can find a colour overview on pages 100 / 101. The Creativo Design motif is marked as colour fields with a number. The same number means all fields with this number will be the same colour.

Composez la combinaison de couleurs de votre choix. Retrouvez l'aperçu des couleurs aux pages 100 / 101. Le motif des Creativo Designs est symbolisé par des cases de couleur avec un chiffre. Un chiffre identique signifie que toutes les cases contenant ce chiffre sont de la même couleur.

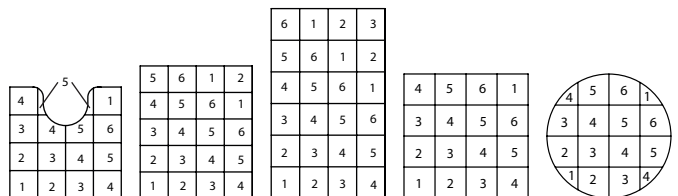

Hinweis: Anzahl und Größe der Linien sind abhängig von der Größe des Badteppichs. Note: The number and size of the lines depends on the size of the bath mat.

Remarque: Le nombre et la taille des lignes dépendent de la taille du tapis de bain.

CENTRO

100% Polyacryl



Florhöhe (mm)

Pile height
Hauteur mèches

20	25
----	----

Deckelbezug (mm)

Lid cover
Housse

25



BELIEBTE GRÖSSEN UND FORMEN / POPULAR SIZES AND SHAPES / TAILLES ET FORMES POPULAIRES



7490 ... 129
ca. 55 x 55 cm



7490 ... 539
ca. 55 x 65 cm



7490 ... 270
ca. 55 x 85 cm



7490 ... 360
ca. 60 x 100 cm



7490 ... 311
ca. 70 x 120 cm



7490 ... 317
ca. 80 x 150 cm



7490 ... 290
ca. 80 x 80 cm

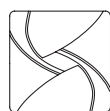

7490 ... 720
ca. 100 x 100 cm

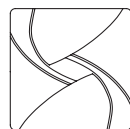

7490 ... 728
ca. 120 x 120 cm



7490 ... 307
ca. 60 cm rund



7490 ... 518
ca. 80 cm rund



7490 ... 521
ca. 100 cm rund



Deckelbezug / Lid cover / Housse
COPERTINA
7434 ... 104
ca. 47 x 50 cm

WUNSCHGRÖSSEN / CUSTOM SIZES / TAILLES SOUHAITÉES



Wählen Sie Ihr individuelles Wunschmaß von 50 x 50 cm bis zu 150 x 300 cm oder rund 50 - 150 cm. Extreme Maße können ggf. zu Verzerrungen führen.

Choose your customised dimensions from 50 x 50 cm up to 150 x 300 cm or 50 - 150 cm (round). Extreme sizes may result in distortions.

Sélectionnez vos dimensions personnalisées, de 50 x 50 cm à 150 x 300 cm, ou de forme ronde de 50 à 150 cm. Des dimensions extrêmes peuvent éventuellement entraîner une distorsion du motif.

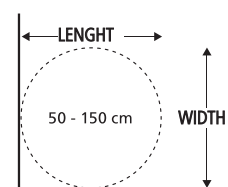
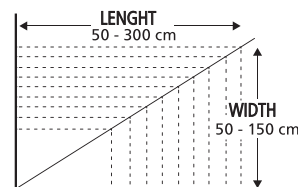

Größen Nr. / Sizes no. / Dimensions n°
Rechteckig / Square / Rectangulaire
Rund / Round / Rond
WC-Vorleger / Contoured rug / Contour WC

qm (000)
qm (093)
qm (092)

BELIEBTE FARBEN / POPULAR COLOURS / COULEURS POPULAIRES



224 Toffee



271 Taupe



396 Lachs



431 Rouge



617 Distel



672 Türkis



798 Königsblau



977 Platin

WUNSCHFARBEN CUSTOM COLOURS / COULEURS SOUHAITÉES

Stellen Sie Ihre eigene Farbkombination zusammen. Eine Farbübersicht finden Sie auf den Seiten 100 / 101. Das Motiv der Creativo Designs ist als Farbfelder mit einer Zahl gekennzeichnet. Gleiche Zahl bedeutet, dass alle Felder mit dieser Zahl die gleiche Farbe haben.

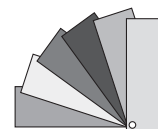

Put together your own colour combination. You can find a colour overview on pages 100 / 101. The Creativo Design motif is marked as colour fields with a number. The same number means all fields with this number will be the same colour.

Composez la combinaison de couleurs de votre choix. Retrouvez l'aperçu des couleurs aux pages 100 / 101. Le motif des Creativo Designs est symbolisé par des cases de couleur avec un chiffre. Un chiffre identique signifie que toutes les cases contenant ce chiffre sont de la même couleur.

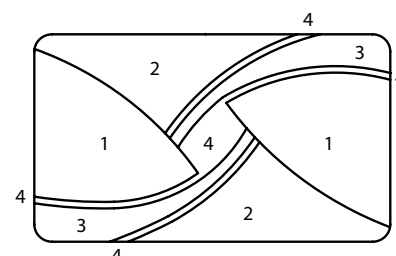

COLLINA

100% Polyacryl



Florhöhe (mm)

Pile height
Hauteur mèches

20 25

Deckelbezug (mm)

Lid cover
Housse

25



BELIEBTE GRÖSSEN UND FORMEN / POPULAR SIZES AND SHAPES / TAILLES ET FORMES POPULAIRES



7489 ... 129
ca. 55 x 55 cm



7489 ... 539
ca. 55 x 65 cm



7489 ... 270
ca. 55 x 85 cm

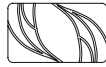

7489 ... 360
ca. 60 x 100 cm

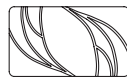

7489 ... 311
ca. 70 x 120 cm

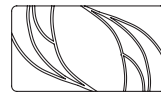

7489 ... 317
ca. 80 x 150 cm



7489 ... 290
ca. 80 x 80 cm



7489 ... 720
ca. 100 x 100 cm

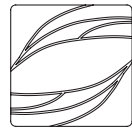

7489 ... 728
ca. 120 x 120 cm



7489 ... 307
ca. 60 cm rund



7489 ... 518
ca. 80 cm rund



7489 ... 521
ca. 100 cm rund



Deckelbezug / Lid cover / Housse
COPERTINA
7434 ... 104
ca. 47 x 50 cm

WUNSCHGRÖSSEN / CUSTOM SIZES / TAILLES SOUHAITÉES



Wählen Sie Ihr individuelles Wunschmaß von 50 x 50 cm bis zu 150 x 300 cm oder rund 50 - 150 cm. Extreme Maße können ggf. zu Verzerrungen führen.

Choose your customised dimensions from 50 x 50 cm up to 150 x 300 cm or 50 - 150 cm (round). Extreme sizes may result in distortions.

Sélectionnez vos dimensions personnalisées, de 50 x 50 cm à 150 x 300 cm, ou de forme ronde de 50 à 150 cm. Des dimensions extrêmes peuvent éventuellement entraîner une distorsion du motif.

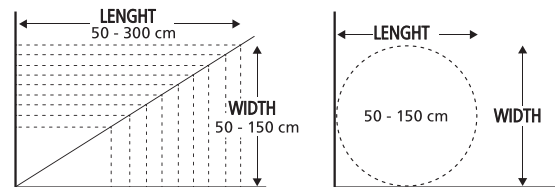

Größen Nr. / Sizes no. / Dimensions n°

Rechteckig / Square / Rectangulaire

Rund / Round / Rond

WC-Vorleger / Contoured rug / Contour WC

qm (000)

qm (093)

qm (092)

BELIEBTE FARBEN / POPULAR COLOURS / COULEURS POPULAIRES



231 Bambusbeige



333 Brandy



451 Weinrot



633 Minze



675 Petrol



783 Mare



872 Aubergine



905 Schiefer

WUNSCHFARBEN CUSTOM COLOURS / COULEURS SOUHAITÉES

Stellen Sie Ihre eigene Farbkombination zusammen. Eine Farbübersicht finden Sie auf den Seiten 100 / 101. Das Motiv der Creativo Designs ist als Farbfelder mit einer Zahl gekennzeichnet. Gleiche Zahl bedeutet, dass alle Felder mit dieser Zahl die gleiche Farbe haben.

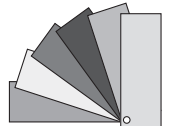

Put together your own colour combination. You can find a colour overview on pages 100 / 101. The Creativo Design motif is marked as colour fields with a number. The same number means all fields with this number will be the same colour.

Composez la combinaison de couleurs de votre choix. Retrouvez l'aperçu des couleurs aux pages 100 / 101. Le motif des Creativo Designs est symbolisé par des cases de couleur avec un chiffre. Un chiffre identique signifie que toutes les cases contenant ce chiffre sont de la même couleur.

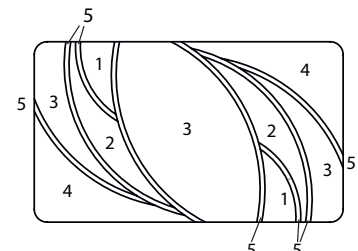

100% Polyacryl



Florhöhe (mm)

Pile height
Hauteur mèches

20 25

Deckelbezug (mm)

Lid cover
Housse

25



BELIEBTE GRÖSSEN UND FORMEN / POPULAR SIZES AND SHAPES / TAILLES ET FORMES POPULAIRES



8817 ... 129
ca. 55 x 55 cm



8817 ... 539
ca. 55 x 65 cm



8817 ... 270
ca. 55 x 85 cm

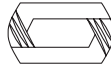

8817 ... 360
ca. 60 x 100 cm

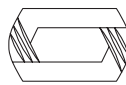

8817 ... 311
ca. 70 x 120 cm

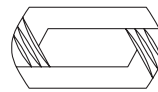

8817 ... 317
ca. 80 x 150 cm



8817 ... 290
ca. 80 x 80 cm

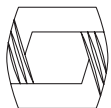

8817 ... 720
ca. 100 x 100 cm

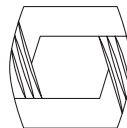

8817 ... 728
ca. 120 x 120 cm



8817 ... 307
ca. 60 cm rund



8817 ... 518
ca. 80 cm rund

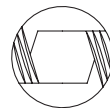

8817 ... 521
ca. 100 cm rund



Deckelbezug / Lid cover / Housse
COPERTINA
7434 ... 104
ca. 47 x 50 cm

WUNSCHGRÖSSEN / CUSTOM SIZES / TAILLES SOUHAITÉES



Wählen Sie Ihr individuelles Wunschmaß von 50 x 50 cm bis zu 150 x 300 cm oder rund 50 - 150 cm. Extreme Maße können ggf. zu Verzerrungen führen.

Choose your customised dimensions from 50 x 50 cm up to 150 x 300 cm or 50 - 150 cm (round). Extreme sizes may result in distortions.

Sélectionnez vos dimensions personnalisées, de 50 x 50 cm à 150 x 300 cm, ou de forme ronde de 50 à 150 cm. Des dimensions extrêmes peuvent éventuellement entraîner une distorsion du motif.

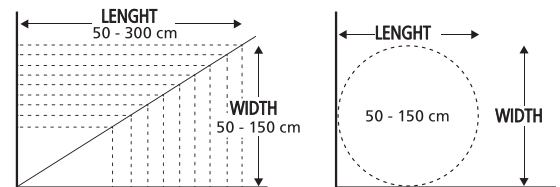

Größen Nr. / Sizes no. / Dimensions n°

Rechteckig / Square / Rectangulaire

Rund / Round / Rond

WC-Vorleger / Contoured rug / Contour WC

qm (000)

qm (093)

qm (092)

BELIEBTE FARBEN / POPULAR COLOURS / COULEURS POPULAIRES



189 Grau



224 Toffee



271 Taupe



322 Pfirsich



413 Pastellrose



453 Rubin



605 Alge



769 Marineblau

WUNSCHFARBEN CUSTOM COLOURS / COULEURS SOUHAITÉES

Stellen Sie Ihre eigene Farbkombination zusammen. Eine Farbübersicht finden Sie auf den Seiten 100 / 101. Das Motiv der Creativo Designs ist als Farbfelder mit einer Zahl gekennzeichnet. Gleiche Zahl bedeutet, dass alle Felder mit dieser Zahl die gleiche Farbe haben.

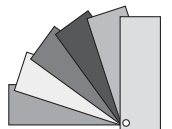

Put together your own colour combination. You can find a colour overview on pages 100 / 101. The Creativo Design motif is marked as colour fields with a number. The same number means all fields with this number will be the same colour.

Composez la combinaison de couleurs de votre choix. Retrouvez l'aperçu des couleurs aux pages 100 / 101. Le motif des Creativo Designs est symbolisé par des cases de couleur avec un chiffre. Un chiffre identique signifie que toutes les cases contenant ce chiffre sont de la même couleur.

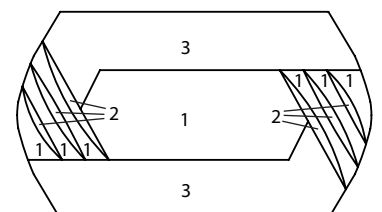

HARMONIA

100% Polyacryl



Florhöhe (mm)

Pile height
Hauteur mèches



Deckelbezug (mm)

Lid cover
Housse



BELIEBTE GRÖSSEN UND FORMEN / POPULAR SIZES AND SHAPES / TAILLES ET FORMES POPULAIRES



8968 ... 129
ca. 55 x 55 cm



8968 ... 539
ca. 55 x 65 cm



8968 ... 270
ca. 55 x 85 cm



8968 ... 360
ca. 60 x 100 cm



8968 ... 311
ca. 70 x 120 cm

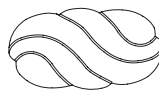

8968 ... 317
ca. 80 x 150 cm



8968 ... 290
ca. 80 x 80 cm

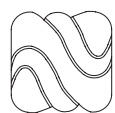

8968 ... 720
ca. 100 x 100 cm

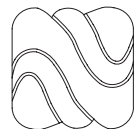

8968 ... 728
ca. 120 x 120 cm



8968 ... 307
ca. 60 cm rund



8968 ... 518
ca. 80 cm rund



8968 ... 521
ca. 100 cm rund



Deckelbezug / Lid cover / Housse
COPERTINA
7434 ... 104
ca. 47 x 50 cm

WUNSCHGRÖSSEN / CUSTOM SIZES / TAILLES SOUHAITÉES



Wählen Sie Ihr individuelles Wunschmaß von 50 x 50 cm bis zu 150 x 300 cm oder rund 50 - 150 cm. Extreme Maße können ggf. zu Verzerrungen führen.

Choose your customised dimensions from 50 x 50 cm up to 150 x 300 cm or 50 - 150 cm (round). Extreme sizes may result in distortions.

Sélectionnez vos dimensions personnalisées, de 50 x 50 cm à 150 x 300 cm, ou de forme ronde de 50 à 150 cm. Des dimensions extrêmes peuvent éventuellement entraîner une distorsion du motif.

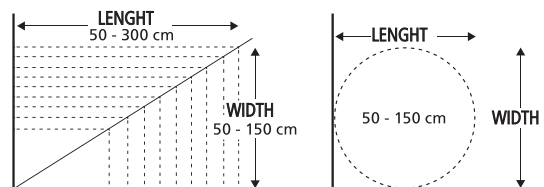

Größen Nr. / Sizes no. / Dimensions n°

Rechteckig / Square / Rectangulaire

Rund / Round / Rond

WC-Vorleger / Contoured rug / Contour WC

qm (000)

qm (093)

qm (092)

BELIEBTE FARBEN / POPULAR COLOURS / COULEURS POPULAIRES



224 Toffee



272 Macadamia



319 Aprikose



442 Flamingo



453 Rubin



602 Klee



720 Blau



901 Anthrazit

WUNSCHFARBEN CUSTOM COLOURS / COULEURS SOUHAITÉES

Stellen Sie Ihre eigene Farbkombination zusammen. Eine Farbübersicht finden Sie auf den Seiten 100 / 101. Das Motiv der Creativo Designs ist als Farbfelder mit einer Zahl gekennzeichnet. Gleiche Zahl bedeutet, dass alle Felder mit dieser Zahl die gleiche Farbe haben.

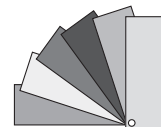

Put together your own colour combination. You can find a colour overview on pages 100 / 101. The Creativo Design motif is marked as colour fields with a number. The same number means all fields with this number will be the same colour.

Composez la combinaison de couleurs de votre choix. Retrouvez l'aperçu des couleurs aux pages 100 / 101. Le motif des Creativo Designs est symbolisé par des cases de couleur avec un chiffre. Un chiffre identique signifie que toutes les cases contenant ce chiffre sont de la même couleur.

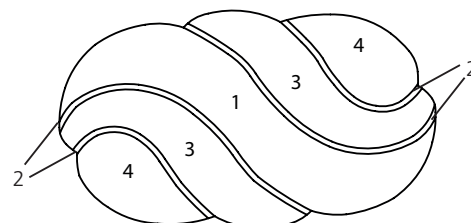

INTERNO

100% Polyacryl



Florhöhe (mm)

Pile height
Hauteur mèches

20 25

Deckelbezug (mm)

Lid cover
Housse

25

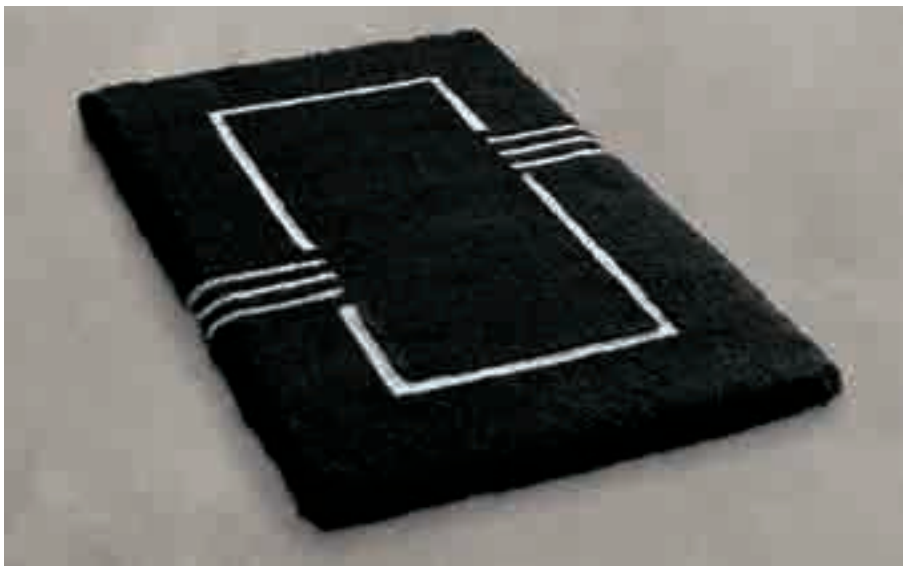

BELIEBTE GRÖSSEN UND FORMEN / POPULAR SIZES AND SHAPES / TAILLES ET FORMES POPULAIRES



8964 ... 129
ca. 55 x 55 cm



8964 ... 539
ca. 55 x 65 cm

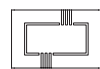

8964 ... 270
ca. 55 x 85 cm

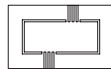

8964 ... 360
ca. 60 x 100 cm

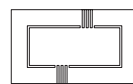

8964 ... 311
ca. 70 x 120 cm

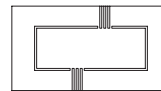

8964 ... 317
ca. 80 x 150 cm



8964 ... 290
ca. 80 x 80 cm

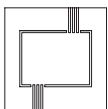

8964 ... 720
ca. 100 x 100 cm

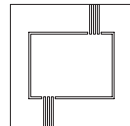

8964 ... 728
ca. 120 x 120 cm



8964 ... 307
ca. 60 cm rund



8964 ... 518
ca. 80 cm rund

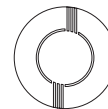

8964 ... 521
ca. 100 cm rund



Deckelbezug / Lid cover / Housse
COPERTINA
7434 ... 104
ca. 47 x 50 cm

WUNSCHGRÖSSEN / CUSTOM SIZES / TAILLES SOUHAITÉES



Wählen Sie Ihr individuelles Wunschmaß von 50 x 50 cm bis zu 150 x 300 cm oder rund 50 - 150 cm. Extreme Maße können ggf. zu Verzerrungen führen.

Choose your customised dimensions from 50 x 50 cm up to 150 x 300 cm or 50 - 150 cm (round). Extreme sizes may result in distortions.

Sélectionnez vos dimensions personnalisées, de 50 x 50 cm à 150 x 300 cm, ou de forme ronde de 50 à 150 cm. Des dimensions extrêmes peuvent éventuellement entraîner une distorsion du motif.

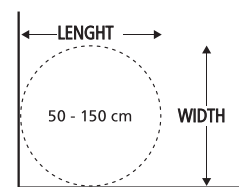
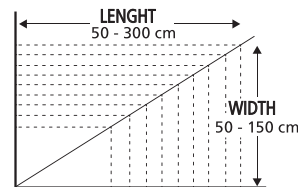

Größen Nr. / Sizes no. / Dimensions n°

Rechteckig / Square / Rectangulaire

Rund / Round / Rond

WC-Vorleger / Contoured rug / Contour WC

qm (000)

qm (093)

qm (092)

BELIEBTE FARBEN / POPULAR COLOURS / COULEURS POPULAIRES



189 Grau



271 Taupe



316 Rost



468 Granat



539 Safran



617 Distel



789 Dunkelblau



926 Schwarz

WUNSCHFARBEN CUSTOM COLOURS / COULEURS SOUHAITÉES

Stellen Sie Ihre eigene Farbkombination zusammen. Eine Farbübersicht finden Sie auf den Seiten 100 / 101. Das Motiv der Creativo Designs ist als Farbfelder mit einer Zahl gekennzeichnet. Gleiche Zahl bedeutet, dass alle Felder mit dieser Zahl die gleiche Farbe haben.

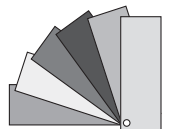

Put together your own colour combination. You can find a colour overview on pages 100 / 101. The Creativo Design motif is marked as colour fields with a number. The same number means all fields with this number will be the same colour.

Composez la combinaison de couleurs de votre choix. Retrouvez l'aperçu des couleurs aux pages 100 / 101. Le motif des Creativo Designs est symbolisé par des cases de couleur avec un chiffre. Un chiffre identique signifie que toutes les cases contenant ce chiffre sont de la même couleur.

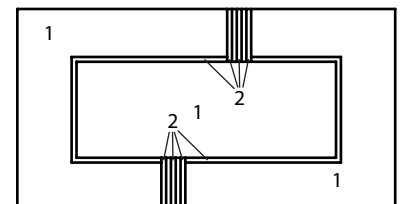

LINEA

100% Polyacryl



Florhöhe (mm)

Pile height
Hauteur mèches

25

Deckelbezug (mm)

Lid cover
Housse

25



BELIEBTE GRÖSSEN UND FORMEN / POPULAR SIZES AND SHAPES / TAILLES ET FORMES POPULAIRES



7550 ... 129
ca. 55 x 55 cm



7550 ... 539
ca. 55 x 65 cm

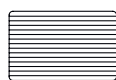

7550 ... 270
ca. 55 x 85 cm

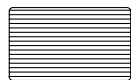

7550 ... 360
ca. 60 x 100 cm

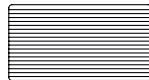

7550 ... 225
ca. 70 x 120 cm



7550 ... 317
ca. 80 x 150 cm



7550 ... 290
ca. 80 x 80 cm

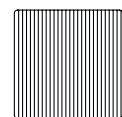

7550 ... 720
ca. 100 x 100 cm

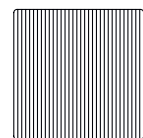

7550 ... 728
ca. 120 x 120 cm



7550 ... 307
ca. 60 cm rund

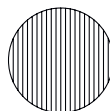

7550 ... 518
ca. 80 cm rund

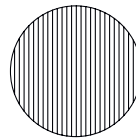

7550 ... 521
ca. 100 cm rund



Deckelbezug / Lid cover / Housse
COPERTINA
7434 ... 104
ca. 47 x 50 cm

WUNSCHGRÖSSEN / CUSTOM SIZES / TAILLES SOUHAITÉES



Wählen Sie Ihr individuelles Wunschmaß von 50 x 50 cm bis zu 150 x 300 cm oder rund 50 - 150 cm. Extreme Maße können ggf. zu Verzerrungen führen.

Choose your customised dimensions from 50 x 50 cm up to 150 x 300 cm or 50 - 150 cm (round). Extreme sizes may result in distortions.

Sélectionnez vos dimensions personnalisées, de 50 x 50 cm à 150 x 300 cm, ou de forme ronde de 50 à 150 cm. Des dimensions extrêmes peuvent éventuellement entraîner une distorsion du motif.

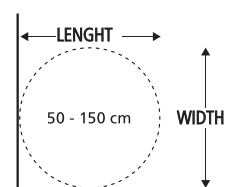
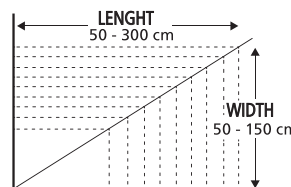

Größen Nr. / Sizes no. / Dimensions n°

Rechteckig / Square / Rectangulaire

Rund / Round / Rond

WC-Vorleger / Contoured rug / Contour WC

qm (000)

qm (093)

qm (092)

BELIEBTE FARBEN / POPULAR COLOURS / COULEURS POPULAIRES



158 Auster

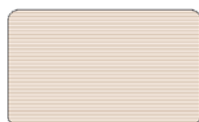

226 Sandbeige

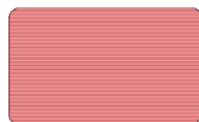

325 Siena

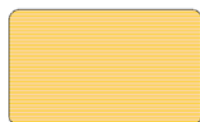

553 Mimose



633 Minze

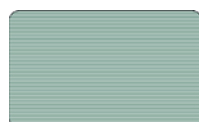

685 Maledivia



754 Iceblue



901 Anthrazit

WUNSCHFARBEN CUSTOM COLOURS / COULEURS SOUHAITÉES

Stellen Sie Ihre eigene Farbkombination zusammen. Eine Farbübersicht finden Sie auf den Seiten 100 / 101. Das Motiv der Creativo Designs ist als Farbfelder mit einer Zahl gekennzeichnet. Gleiche Zahl bedeutet, dass alle Felder mit dieser Zahl die gleiche Farbe haben.

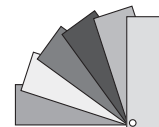

Put together your own colour combination. You can find a colour overview on pages 100 / 101. The Creativo Design motif is marked as colour fields with a number. The same number means all fields with this number will be the same colour.

Composez la combinaison de couleurs de votre choix. Retrouvez l'aperçu des couleurs aux pages 100 / 101. Le motif des Creativo Designs est symbolisé par des cases de couleur avec un chiffre. Un chiffre identique signifie que toutes les cases contenant ce chiffre sont de la même couleur.

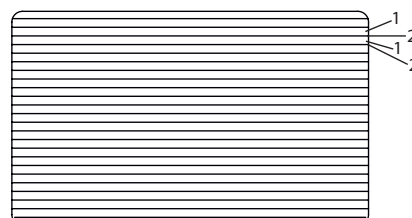

MEANDRO

100% Polyacryl



Florhöhe (mm)

Pile height
Hauteur mèches

20 25

Deckelbezug (mm)

Lid cover
Housse

25



BELIEBTE GRÖSSEN UND FORMEN / POPULAR SIZES AND SHAPES / TAILLES ET FORMES POPULAIRES



7399 ... 129
ca. 55 x 55 cm



7399 ... 539
ca. 55 x 65 cm



7399 ... 270
ca. 55 x 85 cm

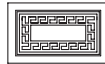

7399 ... 360
ca. 60 x 100 cm

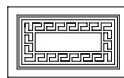

7399 ... 311
ca. 70 x 120 cm

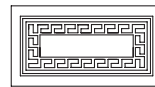

7399 ... 317
ca. 80 x 150 cm



7399 ... 290
ca. 80 x 80 cm

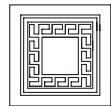

7399 ... 720
ca. 100 x 100 cm

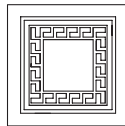

7399 ... 728
ca. 120 x 120 cm



7399 ... 307
ca. 60 cm rund



7399 ... 518
ca. 80 cm rund



7399 ... 521
ca. 100 cm rund



Deckelbezug / Lid cover / Housse
COPERTINA
7434 ... 104
ca. 47 x 50 cm

WUNSCHGRÖSSEN / CUSTOM SIZES / TAILLES SOUHAITÉES



Wählen Sie Ihr individuelles Wunschmaß von 50 x 50 cm bis zu 150 x 300 cm oder rund 50 - 150 cm. Extreme Maße können ggf. zu Verzerrungen führen.

Choose your customised dimensions from 50 x 50 cm up to 150 x 300 cm or 50 = 150 cm (round). Extreme sizes may result in distortions.

Sélectionnez vos dimensions personnalisées, de 50 x 50 cm à 150 x 300 cm, ou de forme ronde de 50 à 150 cm. Des dimensions extrêmes peuvent éventuellement entraîner une distorsion du motif.

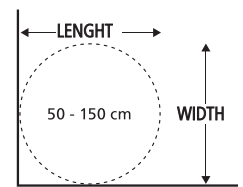
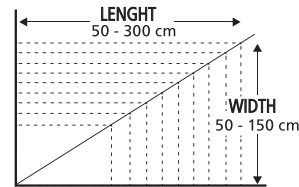

Größen Nr. / Sizes no. / Dimensions n°

Rechteckig / Square / Rectangulaire

Rund / Round / Rond

WC-Vorleger / Contoured rug / Contour WC

qm (000)

qm (093)

qm (092)

BELIEBTE FARBEN / POPULAR COLOURS / COULEURS POPULAIRES



217 Berberbeige



271 Taupe



316 Rost



436 Beere



468 Granat



617 Distel



769 Marineblau



901 Anthrazit

WUNSCHFARBEN CUSTOM COLOURS / COULEURS SOUHAITÉES

Stellen Sie Ihre eigene Farbkombination zusammen. Eine Farbübersicht finden Sie auf den Seiten 100 / 101. Das Motiv der Creativo Designs ist als Farbfelder mit einer Zahl gekennzeichnet. Gleiche Zahl bedeutet, dass alle Felder mit dieser Zahl die gleiche Farbe haben.

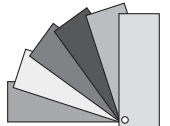

Put together your own colour combination. You can find a colour overview on pages 100 / 101. The Creativo Design motif is marked as colour fields with a number. The same number means all fields with this number will be the same colour.

Composez la combinaison de couleurs de votre choix. Retrouvez l'aperçu des couleurs aux pages 100 / 101. Le motif des Creativo Designs est symbolisé par des cases de couleur avec un chiffre. Un chiffre identique signifie que toutes les cases contenant ce chiffre sont de la même couleur.

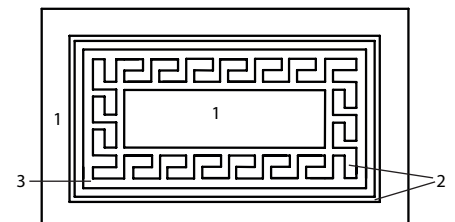

MESSAGGIO



INDIVIDUELL UND PERSONALISIERT.

Die Erinnerung an einen besonderen Tag, den Hochzeitstag oder eine persönliche Botschaft auf dem Badteppich für einen gelungenen Start in den Tag - mit MESSAGGIO ermöglichen wir die höchste Form der Individualität. Als einzigartiges Geschenk zur Geburt oder dem Einzug ins neue Heim realisiert MESSAGGIO auf 3 Größen und mit 2 unterschiedlichen Schriften die Umsetzung von Namen oder persönlichen Nachrichten. Ihre Kunden können aus über 100 Farben ihre Lieblingsfarbe für Schrift und Hintergrund auswählen. Diverse Sonderzeichen sind ebenfalls möglich.

CUSTOMISED.

The memory of a special day, a wedding anniversary or a personal message on the bathroom rug for a wonderful start to the day - with MESSAGGIO we make the ultimate form of customisation possible. Ideal as a unique gift for a birth or to celebrate a move to a new home, MESSAGGIO is available in 3 sizes and with 2 different fonts for names or personal messages. Your customers can select their favourite font and background colour from over 100 colour options. Diverse special characters are also possible.

INDIVIDUEL ET PERSONNALISÉ.

Le souvenir d'un jour spécial, le jour de son mariage ou un message personnalisé sur son tapis de bain pour bien commencer la journée - avec MESSAGGIO, nous rendons possible la personnalisation au plus haut degré. Cadeau unique pour une naissance ou un emménagement, MESSAGGIO transpose les noms et messages personnalisés en 3 tailles et avec 2 polices différentes. Vos clients peuvent choisir leur couleur préférée de police et de fond parmi plus de 100 couleurs. Divers caractères spéciaux sont également possibles.

100% Polyacryl



Florhöhe (mm)
Pile height
Hauteur mèches

15

Deckelbezug (mm)
Lid cover
Housse

25

BELIEBTE GRÖSSEN UND FORMEN / POPULAR SIZES AND SHAPES / TAILLES ET FORMES POPULAIRES



7553... 539
ca. 55 x 65 cm



7553 ... 360
ca. 60 x 100 cm



7553 ... 225
ca. 70 x 120 cm



Deckelbezug / Lid cover / Housse
COPERTINA
7434 ... 104
ca. 47 x 50 cm

AUSWAHL DER SCHRIFTEN / SELECTION OF THE FONT SELECTION / CHOIX DE LA POLICE DE CARACTÈRES



Schrift mit Serifen / Font with serifs /
Police de caractères avec empattement



Schrift ohne Serifen / Font without serifs /
Police de caractères sans empattement

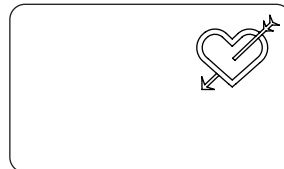

Sonderzeichen / Special characters /
Caractères spéciaux

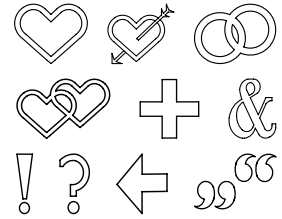

ANZAHL DER SCHRIFTZEICHEN / ANZAHL DER SCHRIFTZEICHEN / ANZAHL DER SCHRIFTZEICHEN

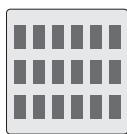

55 x 65 cm
max. 6 Zeichen pro Zeile
max. 6 characters per line
max. 6 caractères par ligne

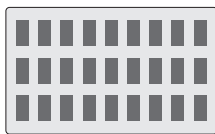

60 x 100 cm
max. 9 Zeichen pro Zeile
max. 9 characters per line
max. 9 caractères par ligne

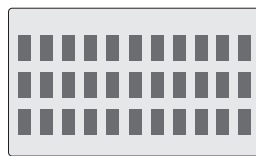

70 x 120 cm
max. 11 Zeichen pro Zeile
max. 11 characters per line
max. 11 caractères par ligne

Hinweis: Maximal 3 Zeilen. Sonderzeichen benötigen 2 Buchstaben, Zeichenbegrenzung gewährleistet, dass Schrift gut lesbar ist.

Note: Max. 3 lines. Special characters require 2 letters, character limit ensures that lettering is easy to read.

Remarque: Max. 3 lignes Les caractères spéciaux nécessitent 2 lettres, la limite de caractères garantit une bonne lisibilité de l'écriture.

BELIEBTE FARBEN / POPULAR COLOURS / COULEURS POPULAIRES



333 Brandy



443 Magnolie



463 Cassis



468 Granat



568 Sunshine



625 Maigrün



720 Blau



913 Nebel

WUNSCHFARBEN / CUSTOM COLOURS / COULEURS SOUHAITÉES

Stellen Sie Ihre eigene Farbkombination zusammen. Eine Farbübersicht finden Sie auf den Seiten 100 / 101. Das Motiv der Creativo Designs ist als Farbfelder mit einer Zahl gekennzeichnet. Gleiche Zahl bedeutet, dass alle Felder mit dieser Zahl die gleiche Farbe haben.

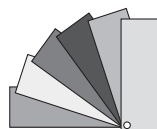

Put together your own colour combination. You can find a colour overview on pages 100 / 101. The Creativo Design motif is marked as colour fields with a number. The same number means all fields with this number will be the same colour.

Composez la combinaison de couleurs de votre choix. Retrouvez l'aperçu des couleurs aux pages 100 / 101. Le motif des Creativo Designs est symbolisé par des cases de couleur avec un chiffre. Un chiffre identique signifie que toutes les cases contenant ce chiffre sont de la même couleur.

NOVERO

100% Polyacryl



Florhöhe (mm)

Pile height
Hauteur mèches

15

Deckelbezug (mm)

Lid cover
Housse

25



BELIEBTE GRÖSSEN UND FORMEN / POPULAR SIZES AND SHAPES / TAILLES ET FORMES POPULAIRES



7549 ... 129
ca. 55 x 55 cm



7549 ... 539
ca. 55 x 65 cm



7549 ... 270
ca. 55 x 85 cm



7549 ... 360
ca. 60 x 100 cm



7549 ... 225
ca. 70 x 120 cm

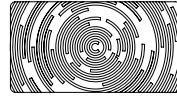

7549 ... 317
ca. 80 x 150 cm



7549 ... 290
ca. 80 x 80 cm

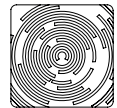

7549 ... 720
ca. 100 x 100 cm

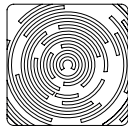

7549 ... 728
ca. 120 x 120 cm



7549 ... 307
ca. 60 cm rund



7549 ... 518
ca. 80 cm rund

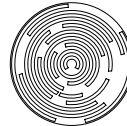

7549 ... 521
ca. 100 cm rund



Deckelbezug / Lid cover / Housse
COPERTINA
7434 ... 104
ca. 47 x 50 cm

WUNSCHGRÖSSEN / CUSTOM SIZES / TAILLES SOUHAITÉES



Wählen Sie Ihr individuelles Wunschmaß von 50 x 50 cm bis zu 150 x 300 cm oder rund 50 - 150 cm. Extreme Maße können ggf. zu Verzerrungen führen.

Choose your customised dimensions from 50 x 50 cm up to 150 x 300 cm or 50 - 150 cm (round). Extreme sizes may result in distortions.
Sélectionnez vos dimensions personnalisées, de 50 x 50 cm à 150 x 300 cm, ou de forme ronde de 50 à 150 cm. Des dimensions extrêmes peuvent éventuellement entraîner une distorsion du motif.

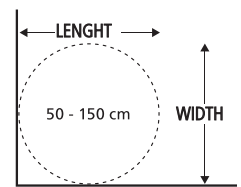
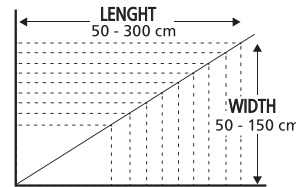

Größen Nr. / Sizes no. / Dimensions n°

Rechteckig / Square / Rectangulaire

Rund / Round / Rond

WC-Vorleger / Contoured rug / Contour WC

qm (000)

qm (093)

qm (092)

BELIEBTE FARBEN / POPULAR COLOURS / COULEURS POPULAIRES



158 Auster



226 Sandbeige



319 Aprikose

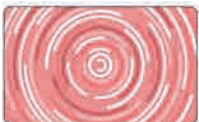

325 Siena



553 Mimose



685 Maledivia

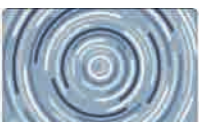

746 Stahlblau



926 Schwarz

WUNSCHFARBEN CUSTOM COLOURS / COULEURS SOUHAITÉES

Stellen Sie Ihre eigene Farbkombination zusammen. Eine Farbübersicht finden Sie auf den Seiten 100 / 101. Das Motiv der Creativo Designs ist als Farbfelder mit einer Zahl gekennzeichnet. Gleiche Zahl bedeutet, dass alle Felder mit dieser Zahl die gleiche Farbe haben.

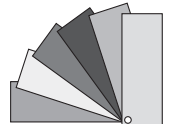

Put together your own colour combination. You can find a colour overview on pages 100 / 101. The Creativo Design motif is marked as colour fields with a number. The same number means all fields with this number will be the same colour.

Composez la combinaison de couleurs de votre choix. Retrouvez l'aperçu des couleurs aux pages 100 / 101. Le motif des Creativo Designs est symbolisé par des cases de couleur avec un chiffre. Un chiffre identique signifie que toutes les cases contenant ce chiffre sont de la même couleur.

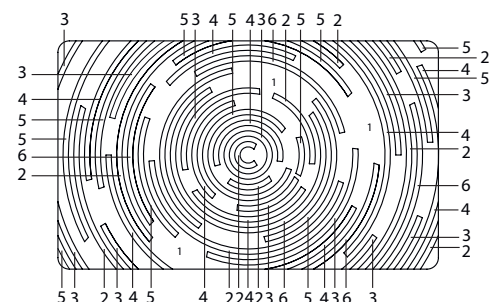

100% Polyacryl



Florhöhe (mm) Pile height Hauteur mèches	25
Deckelbezug (mm) Lid cover Housse	25



BELIEBTE GRÖSSEN UND FORMEN / POPULAR SIZES AND SHAPES / TAILLES ET FORMES POPULAIRES



7491 ... 129
ca. 55 x 55 cm



7491 ... 539
ca. 55 x 65 cm



7491 ... 270
ca. 55 x 85 cm



7491 ... 428
ca. 65 x 100 cm



7491 ... 449
ca. 75 x 120 cm



7491 ... 227
ca. 90 x 150 cm



7491 ... 290
ca. 80 x 80 cm



7491 ... 720
ca. 100 x 100 cm



7491 ... 728
ca. 120 x 120 cm



7491 ... 307
ca. 60 cm rund



7491 ... 518
ca. 80 cm rund



7491 ... 521
ca. 100 cm rund



Deckelbezug / Lid cover / Housse
COPERTINA
7434 ... 104
ca. 47 x 50 cm

WUNSCHGRÖSSEN / CUSTOM SIZES / TAILLES SOUHAITÉES



Wählen Sie Ihr individuelles Wunschmaß von 50 x 50 cm bis zu 150 x 300 cm oder rund 50 - 150 cm. Extreme Maße können ggf. zu Verzerrungen führen.

Choose your customised dimensions from 50 x 50 cm up to 150 x 300 cm or 50 - 150 cm (round). Extreme sizes may result in distortions.

Sélectionnez vos dimensions personnalisées, de 50 x 50 cm à 150 x 300 cm, ou de forme ronde de 50 à 150 cm. Extreme Maße können ggf. zu Verzerrungen führen.

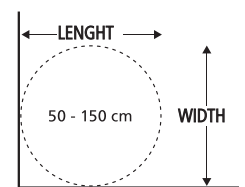
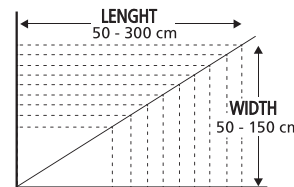

Größen Nr. / Sizes no. / Dimensions n°
Rechteckig / Square / Rectangulaire
Rund / Round / Rond
WC-Vorleger / Contoured rug / Contour WC
qm (000)
qm (093)
qm (092)

BELIEBTE FARBEN / POPULAR COLOURS / COULEURS POPULAIRES



272 Macadamia



322 Pfirsich



327 Marsala



413 Pastellrose



431 Rouge



617 Distel



754 Iceblue



977 Platin

WUNSCHFARBEN CUSTOM COLOURS / COULEURS SOUHAITÉES

Stellen Sie Ihre eigene Farbkombination zusammen. Eine Farbübersicht finden Sie auf den Seiten 100 / 101. Das Motiv der Creativo Designs ist als Farbfelder mit einer Zahl gekennzeichnet. Gleiche Zahl bedeutet, dass alle Felder mit dieser Zahl die gleiche Farbe haben.

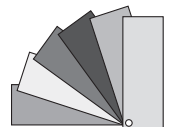

Put together your own colour combination. You can find a colour overview on pages 100 / 101. The Creativo Design motif is marked as colour fields with a number. The same number means all fields with this number will be the same colour.

Composez la combinaison de couleurs de votre choix. Retrouvez l'aperçu des couleurs aux pages 100 / 101. Le motif des Creativo Designs est symbolisé par des cases de couleur avec un chiffre. Un chiffre identique signifie que toutes les cases contenant ce chiffre sont de la même couleur.

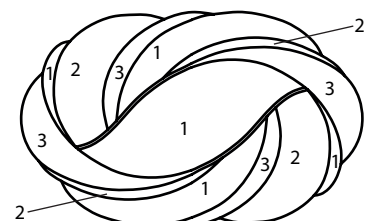

Accessoires





ADONA

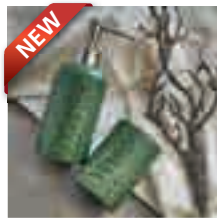

BRACE



DASH

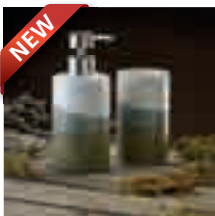

MOSS



OPALIS



RUNA

ACAIA	132
ALVA	132
ADONA	133
ANCHOR	134
ANTOINETTE	134
ARCO	135
ARGENTIC	135
BELGRANO	136
BELLY	137
BENTO	137
BLAZE	138
BONNY	138
BOW	139
BREEZE	139
BRACE	140
CONCHA	141
CRACKLE	142
CRINKLE	142
CROSSOVER	143
CUBIC	143
DASH	144
DOTTY	145
DRIP	145
ECLIPSE	146
EASY	147
FLASH	147
FORTUNE	148
GLAMOUR	148
GOLA	149
GOLDEN CRACKLE	149
GROOVE	150
KYOTO	150
LEAF	151
MABLE	151
MADERA	152
MARBLE	153
MARMOR	153
MELUA	154
MERCURY	154
MOSS	155
NAVAGIO	156
OPALIS	157
PALM	158
PINO	158
PUR	159
PUR SHINY	159
RUNA	160
SAHARA	161
SAVANNAH	161
SARDINAS	162
SERENA	163
SOAP	163
STONES	164
STREAM	164
TIMBER	165
TOUCHLESS	165
ERSATZTEILE	166-167

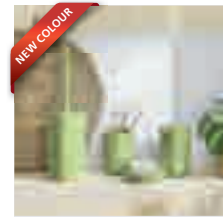

BELGRANO



CONCHA



ECLIPSE



MADERA

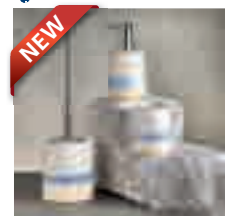

NAVAGIO



SARDINAS

ACAIA

Akazie / Acacia



318
Braun



8610 ... 853
Seifenschale
Soap dish
Porte-savon



8610 ... 852
Zahnputzbecher
Tumbler
Gobelet de brosse à dents

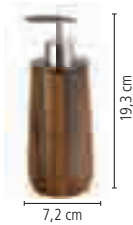

8610 ... 854
Seifenspender
Soap dispenser
Dispenseur de savon



8610 ... 856
WC-Bürstengarnitur
Toilet brush holder
Porte-brosse de toilette



ALVA

Steinzeug + Bambus
Stoneware + Bamboo / Object en terre cuite + Bambou



185
Schwarz Weiß

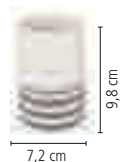

8095 ... 852
Zahnputzbecher
Tumbler
Gobelet de brosse à dents



8095 ... 854
Seifenspender
Soap dispenser
Dispenseur de savon



8095 ... 856
WC-Bürstengarnitur
Toilet brush holder
Porte-brosse de toilette



NEW



ADONA

Polyresin / Polyresin / Polyrésine



8672 ... 856
WC-Bürstengarnitur
Toilet brush holder
Porte-brosse de toilette



8672 ... 854
Seifenspender
Soap dispenser
Dispenseur de savon



8672 ... 852
Zahnputzbecher
Tumbler
Gobelet de brosse à dents



158
Auster



812
Holunder



851
Lavendel

ANCHOR

Steinzeug / Stoneware / Object en terre cuite



789
Dunkelblau

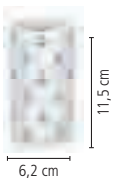

5876 ... 852
Zahnputzbecher
Tumbler
Gobelet de brosse à dents



5876 ... 854
Seifenspender
Soap dispenser
Dispenseur de savon



5876 ... 856
WC-Bürstengarnitur
Toilet brush holder
Porte-brosse de toilette



ANTOINETTE

Glas / Glass / Verre



606
Olivgrün



8034 ... 852
Zahnputzbecher
Tumbler
Gobelet de brosse à dents



8034 ... 854
Seifenspender
Soap dispenser
Dispenseur de savon



ARCO

Glas / Glass / Verre



301
Nussbraun

8641 ... 854
Seifenspender
Soap dispenser
Dispenseur de savon

ARGENTIC

Steinzeug / Stoneware / Object en terre cuite



783
Mare



8470 ... 856
WC-Bürstengarnitur
Toilet brush holder
Porte-brosse de toilette



8470 ... 854
Seifenspender
Soap dispenser
Dispenseur de savon



8470 ... 852
Zahnputzbecher
Tumbler
Gobelet de brosse à dents

NEW COLOUR



BELGRANO

Bambushäcksel/ Bamboo shreds / Déchiquetages de bambou
Polypropylen/ Polypropylene / Polypropylène



226
Sandbeige



401
Nelke



603
Palme



913
Nebel

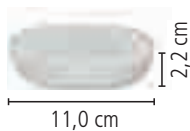

8614 ... 853
Seifenschale
Soap dish
Porte-savon



8614 ... 851
Zahnbürstenhalter
Tumbler
Gobelet de brosse à dents



8614 ... 854
Seifenspender
Soap dispenser
Dispenseur de savon



8614 ... 856
WC-Bürstengarnitur
Toilet brush holder
Porte-brosse de toilette

BELLY

Glas + Silikon / Glass + silicone / Verre + silicone



606
Olivgrün



783
Mare



8471 ... 856
WC-Bürstengarnitur
Toilet brush holder
Porte-brosse de toilette



8471 ... 854
Seifenspender
Soap dispenser
Dispenseur de savon



8471 ... 852
Zahnputzbecher
Tumbler
Gobelet de brosse à dents

BENTO

PS Polystrol



100
Weiß



698
Eucalyptus



8027 ... 856
WC-Bürstengarnitur
Toilet brush holder
Porte-brosse de toilette



***8027 ... 854**
Seifenspender
Soap dispenser
Dispenseur de savon



***8027 ... 852**
Zahnputzbecher
Tumbler
Gobelet de brosse à dents
*VE = 2 Stück

BLAZE

Steinzeug / Stoneware / Object en terre cuite



148
Multicolor



8644 ... 852
Zahnputzbecher
Tumbler
Gobelet de brosse à dents



8644 ... 854
Seifenspender
Soap dispenser
Dispenseur de savon



8644 ... 856
WC-Bürstengarnitur
Toilet brush holder
Porte-brosse de toilette



BONNY

Polyresin / Polyresin / Polyrésine



100
Weiß



926
Schwarz

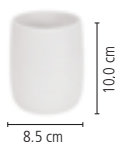

8035 ... 852
Zahnputzbecher
Tumbler
Gobelet de brosse à dents



8035 ... 854
Seifenspender
Soap dispenser
Dispenseur de savon



8035 ... 856
WC-Bürstengarnitur
Toilet brush holder
Porte-brosse de toilette



BOW

Steinzeug / Stoneware / Object en terre cuite



8639 ... 856
WC-Bürstengarnitur
Toilet brush holder
Porte-brosse de toilette



301
Nussbraun



314
Cappuccino



8639 ... 854
Seifenspender
Soap dispenser
Dispenseur de savon



8639 ... 852
Zahnputzbecher
Tumbler
Gobelet de brosse à dents

BREEZE

ABS Kunststoff / ABS Plastic / ABS Plastique



8089 ... 856
WC-Bürstengarnitur
Toilet brush holder
Porte-brosse de toilette



685
Maledivia



913
Nebel



***8089 ... 854**
Seifenspender
Soap dispenser
Dispenseur de savon



***8089 ... 852**
Zahnputzbecher
Tumbler
Gobelet de brosse à dents

*VE = 2 Stück

NEW



BRACE

Polyresin mit über 70% Recyclinganteil / Polyresin with over 70% recycled material /
 Polyrésine avec plus de 70 % de contenu recyclé



612
Forrest



8671 ... 852
Zahnputzbecher
Tumbler
Gobelet de brosse à dents



8671 ... 854
Seifenspender
Soap dispenser
Dispenseur de savon



8671 ... 856
WC-Bürstengarnitur
Toilet brush holder
Porte-brosse de toilette

NEW



CONCHA

Steinzeug / Stoneware / Object en terre cuite



8668 ... 856
WC-Bürstengarnitur
Toilet brush holder
Porte-brosse de toilette



8668 ... 854
Seifenspender
Soap dispenser
Dispenseur de savon



8668 ... 852
Zahnputzbecher
Tumbler
Gobelet de brosse à dents



8668 ... 853
Seifenschale
Soap dish
Porte-savon



100
Weiß

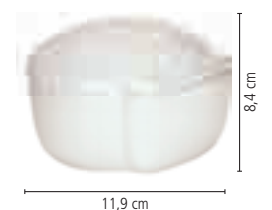

8668 ... 873
Dose
Can
Peut

CRACKLE



Polyresin / Polyresin / Polyrésine



100
Weiß



226
Sandbeige



291
Bast



332
Rosenholz



431
Rouge



649
Opal



685
Maledivia



697
Pacific



783
Mare



926
Schwarz



977
Platin



8,0 cm

10,0 cm



8,0 cm

17,0 cm



10,6 cm

39,0 cm

8430 ... 852
Zahnputzbecher
Tumbler
Gobelet de brosse à dents

8430 ... 854
Seifenspender
Soap dispenser
Dispenseur de savon

8430 ... 856
WC-Bürstengarnitur
Toilet brush holder
Porte-brosse de toilette



CRINKLE

Steinzeug / Stoneware / Object en terre cuite



100
Weiß



7,8 cm

10,9 cm



7,8 cm

17,4 cm



11,3 cm

41,0 cm

8643 ... 852
Zahnputzbecher
Tumbler
Gobelet de brosse à dents

8643 ... 854
Seifenspender
Soap dispenser
Dispenseur de savon

8643 ... 856
WC-Bürstengarnitur
Toilet brush holder
Porte-brosse de toilette



CROSSOVER

Polyresin + Bambus / Polyresin + bamboo / Polyrésine + bambou



100
Weiß



926
Schwarz



8094 ... 856
WC-Bürstengarnitur
Toilet brush holder
Porte-brosse de toilette



8094 ... 854
Seifenspender
Soap dispenser
Dispenseur de savon

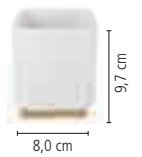

8094 ... 852
Zahnputzbecher
Tumbler
Gobelet de brosse à dents

CUBIC

Steinzeug / Stoneware / Object en terre cuite



100
Weiß



202
Natur



901
Anthrazit



5066 ... 856
WC-Bürstengarnitur
Toilet brush holder
Porte-brosse de toilette



5066 ... 854
Seifenspender
Soap dispenser
Dispenseur de savon

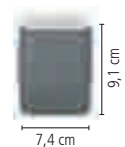

5066 ... 852
Zahnputzbecher
Tumbler
Gobelet de brosse à dents

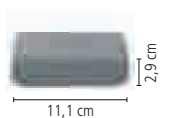

5066 ... 853
Seifenschale
Soap dish
Porte-savon

NEW



DASH

Polyresin/Bambus / Polyresin/ Bamboo / Polyrésine /Bambou



754
Iceblue



616
Dill



8667 ... 873
Dose
Can
Peut

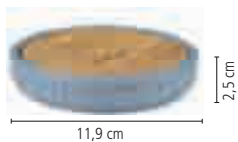

8667 ... 853
Seifenschale
Soap dish
Porte-savon



8667 ... 852
Zahnputzbecher
Tumbler
Gobelet de brosse à dents



8667 ... 854
Seifenspender
Soap dispenser
Dispenseur de savon



8667 ... 856
WC-Bürstengarnitur
Toilet brush holder
Porte-brosse de toilette

Das passt dazu:

That fits: / Ça correspond:

DASH TRAY
Dekoschale
Decorative tray
Plateau décoratif
< Seite 156



DOTTY

Steinzeug / Stoneware / Object en terre cuite



100
Weiß



226
Sandbeige



537
Solaris



652
Schilf



698
Eucalyptus



11,0 cm

8030 ... 856
WC-Bürstengarnitur
Toilet brush holder
Porte-brosse de toilette



8,0 cm

8030 ... 854
Seifenspender
Soap dispenser
Dispenseur de savon



8,0 cm

8030 ... 852
Zahnputzbecher
Tumbler
Gobelet de brosse à dents



13,3 cm

8030 ... 873
Dose
Can
Peut

DRIP

Polyresin gummiert / Polyresin gummed / Polyrésin caoutchouté



226
Sandbeige



783
Mare



926
Schwarz



10,6 cm

8088 ... 856
WC-Bürstengarnitur
Toilet brush holder
Porte-brosse de toilette



8,8 cm

8088 ... 854
Seifenspender
Soap dispenser
Dispenseur de savon



7,8 cm

8088 ... 852
Zahnputzbecher
Tumbler
Gobelet de brosse à dents

NEW COLOUR



ECLIPSE

Steinzeug gummiert/ Stoneware gummed / Object en terre cuite caoutchouté



226
Sandbeige



496
Vino



812
Holunder



852
Erika



913
Nebel



8036 ... 853
Seifenschale
Soap dish
Porte-savon



8036 ... 852
Zahnputzbecher
Tumbler
Gobelet de brosse à dents



8036 ... 854
Seifenspender
Soap dispenser
Dispenseur de savon



8036 ... 856
WC-Bürstengarnitur
Toilet brush holder
Porte-brosse de toilette

EASY

AS Kunststoff / AS Plastic / AS Plastique

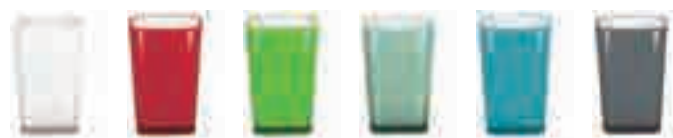

114 Schneeweiß **459** Mohnrot **645** Grün **685** Maledivia **766** Türkis **901** Anthrazit

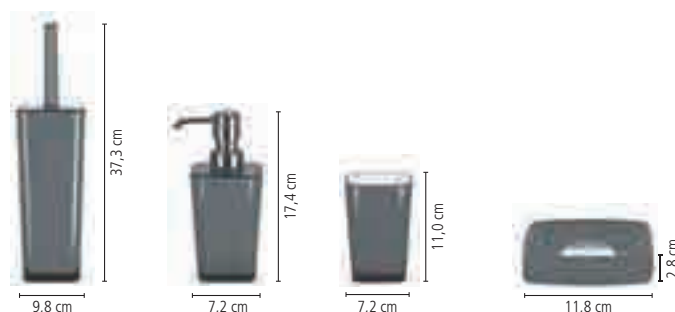

5061 ... 856 WC-Bürstengarnitur
Toilet brush holder
Porte-brosse de toilette

5061 ... 854 Seifenspender
Soap dispenser
Dispenseur de savon

5061 ... 852 Zahnputzbecher
Tumbler
Gobelet de brosse à dents

5061 ... 853 Seifenschale
Soap dish
Porte-savon



FLASH

Steinzeug / Stoneware / Objet en terre cuite



114 Schneeweiß



5045 ... 852 Zahnputzbecher
Tumbler
Gobelet de brosse à dents



5045 ... 853 Seifenschale
Soap dish
Porte-savon



5045 ... 856 WC-Bürstengarnitur
Toilet brush holder
Porte-brosse de toilette



5045 ... 849 Seifenspender Flakon
Bottle of Soap dispenser
Flacon dispenseur de savon



5045 ... 854 Seifenspender
Soap dispenser
Dispenseur de savon

FORTUNE

AS Kunststoff / AS Plastic / AS Plastique



108
Milky



116
Clear



5058 ... 853
Seifenschale
Soap dish
Porte-savon



5058 ... 852
Zahnputzbecher
Tumbler
Gobelet de brosse à dents



5058 ... 854
Seifenspender
Soap dispenser
Dispenseur de savon



5058 ... 856
WC-Bürstengarnitur
Toilet brush holder
Porte-brosse de toilette



GLAMOUR

Steinzeug / Stoneware / Object en terre cuite



124
Silber



125
Gold

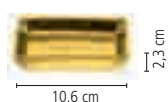

5065 ... 853
Seifenschale
Soap dish
Porte-savon



5065 ... 855
Kammschale



5065 ... 852
Zahnputzbecher
Tumbler
Gobelet de brosse à dents



5065 ... 854
Seifenspender
Soap dispenser
Dispenseur de savon



5065 ... 856
WC-Bürstengarnitur
Toilet brush holder
Porte-brosse de toilette



GOLA

Steinzeug / Stoneware / Object en terre cuite



312
Platane



431
Rouge



8638 ... 856
WC-Bürstengarnitur
Toilet brush holder
Porte-brosse de toilette



8638 ... 854
Seifenspender
Soap dispenser
Dispenseur de savon



8638 ... 852
Zahnputzbecher
Tumbler
Gobelet de brosse à dents

GOLDEN CRACKLE

Polyresin / Polyresin / Polyrésin



100
Weiß



926
Schwarz



8431 ... 856
WC-Bürstengarnitur
Toilet brush holder
Porte-brosse de toilette



8431 ... 854
Seifenspender
Soap dispenser
Dispenseur de savon



8431 ... 852
Zahnputzbecher
Tumbler
Gobelet de brosse à dents

GROOVE

Steinzeug gummiert / Stoneware gummed
Object en terre cuite caoutchouté



291
Bast



314
Cappuccino



398
Pearl

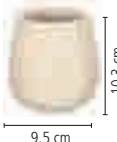

8091 ... 852
Zahnputzbecher
Tumbler
Gobelet de brosse à dents



8091 ... 854
Seifenspender
Soap dispenser
Dispenseur de savon



8091 ... 856
WC-Bürstengarnitur
Toilet brush holder
Porte-brosse de toilette



KYOTO

Polyresin + Bambus / Polyresin + bamboo
Polyrésine + bambou



100
Weiß



272
Macadamia



652
Schilf



926
Schwarz



977
Platin

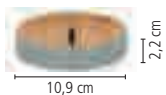

5079 ... 853
Seifenschale
Soap dish
Porte-savon



5079 ... 852
Zahnputzbecher
Tumbler
Gobelet de brosse à dents

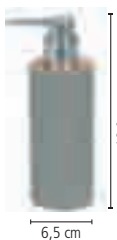

5079 ... 854
Seifenspender
Soap dispenser
Dispenseur de savon

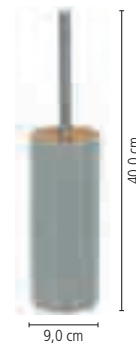

5079 ... 856
WC-Bürstengarnitur
Toilet brush holder
Porte-brosse de toilette



LEAF

Steinzeug / Stoneware / Object en terre cuite



697
Pacific



8031 ... 856
WC-Bürstengarnitur
Toilet brush holder
Porte-brosse de toilette



8031 ... 854
Seifenspender
Soap dispenser
Dispenseur de savon



8031 ... 852
Zahnputzbecher
Tumbler
Gobelet de brosse à dents

MABLE

AS Kunststoff / AS Plastic / AS Plastique



685
Maledivia



977
Platin



5841 ... 856
WC-Bürstengarnitur
Toilet brush holder
Porte-brosse de toilette



5841 ... 854
Seifenspender
Soap dispenser
Dispenseur de savon



5841 ... 852
Zahnputzbecher
Tumbler
Gobelet de brosse à dents

NEW



MADERA

Akazie / Acacia



318
Braun



8670 ... 852
Zahnputzbecher
Tumbler
Gobelet de brosse à dents



8670 ... 854
Seifenspender
Soap dispenser
Dispenseur de savon



8670 ... 849
Seifenspender Flakon
Bottle of Soap dispenser
Flacon dispenseur de savon

MARBLE

Porzellan / Porcelain / Porcelaine



901
Anthrazit



5854 ... 856
WC-Bürstengarnitur
Toilet brush holder
Porte-brosse de toilette



5854 ... 854
Seifenspender
Soap dispenser
Dispenseur de savon



5854 ... 852
Zahnputzbecher
Tumbler
Gobelet de brosse à dents

MARMOR

Glas / Glass / Verre



901
Anthrazit



8033 ... 856
WC-Bürstengarnitur
Toilet brush holder
Porte-brosse de toilette



8033 ... 854
Seifenspender
Soap dispenser
Dispenseur de savon



8033 ... 852
Zahnputzbecher
Tumbler
Gobelet de brosse à dents

MELUA

Glas / Glass / Verre



226
Sandbeige



685
Maledivia



901
Anthrazit

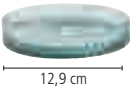

8615 ... 853
Seifenschale
Soap dish
Porte-savon



8615 ... 852
Zahnputzbecher
Tumbler
Gobelet de brosse à dents



8615 ... 854
Seifenspender
Soap dispenser
Dispenseur de savon



8615 ... 856
WC-Bürstengarnitur
Toilet brush holder
Porte-brosse de toilette



MERCURY

Glas / Glass / Verre



403
Koralle



664
Evergreen



5898 ... 852
Zahnputzbecher
Tumbler
Gobelet de brosse à dents



5898 ... 854
Seifenspender
Soap dispenser
Dispenseur de savon



5898 ... 856
WC-Bürstengarnitur
Toilet brush holder
Porte-brosse de toilette



NEW



MOSS

Steinzeug / Stoneware / Object en terre cuite



8669 ... 856
WC-Bürstengarnitur
Toilet brush holder
Porte-brosse de toilette



8669 ... 854
Seifenspender
Soap dispenser
Dispenseur de savon



8669 ... 852
Zahnputzbecher
Tumbler
Gobelet de brosse à dents



612
Forest

NEW



NAVAGIO

Steinzeug / Stoneware / Object en terre cuite



746
Stahlblau



8666 ... 852
Zahnputzbecher
Tumbler
Gobelet de brosse à dents



8666 ... 854
Seifenspender
Soap dispenser
Dispenseur de savon



8666 ... 856
WC-Bürstengarnitur
Toilet brush holder
Porte-brosse de toilette

NEW



OPALIS

Glas / Glass / Verre



213
Perlmutter



8673 ... 856
WC-Bürstengarnitur
Toilet brush holder
Porte-brosse de toilette



8673 ... 854
Seifenspender
Soap dispenser
Dispenseur de savon



8673 ... 852
Zahnputzbecher
Tumbler
Gobelet de brosse à dents

PALM

Steinzeug + Akazie / Stoneware + Acacia
Object en terre cuite + Acacia



685
Maledivia



8092 ... 852
Zahnputzbecher
Tumbler
Gobelet de brosse à dents



8092 ... 854
Seifenspender
Soap dispenser
Dispenseur de savon



8092 ... 856
WC-Bürstengarnitur
Toilet brush holder
Porte-brosse de toilette



PINO

Polystyrol / Polystyrol / Polystyrol



116
Clear



901
Anthrazit



5059 ... 852
Zahnputzbecher
Tumbler
Gobelet de brosse à dents



5059 ... 854
Seifenspender
Soap dispenser
Dispenseur de savon



PUR

Porzellan gummiert / porcelain gummed / Porcelaine gommée



100
Weiß



901
Anthrazit



926
Schwarz



5055 ... 856
WC-Bürstengarnitur
Toilet brush holder
Porte-brosse de toilette



5055 ... 854
Seifenspender
Soap dispenser
Dispenseur de savon



5055 ... 852
Zahnputzbecher
Tumbler
Gobelet de brosse à dents

PUR SHINY

Steinzeug / Stoneware / Object en terre cuite



114
Schneeweiß



5084 ... 856
WC-Bürstengarnitur
Toilet brush holder
Porte-brosse de toilette



5084 ... 854
Seifenspender
Soap dispenser
Dispenseur de savon



5084 ... 848
Schaumspender
Foam dispenser
Distributeur de mousse



5084 ... 852
Zahnputzbecher
Tumbler
Gobelet de brosse à dents

NEW COLOUR



RUNA

Polyresin / Polyresin / Polyrésine



202
Natur



616
Dill



8087 ... 852
Zahnputzbecher
Tumbler
Gobelet de brosse à dents



8087 ... 854
Seifenspender
Soap dispenser
Dispenseur de savon



8087 ... 856
WC-Bürstengarnitur
Toilet brush holder
Porte-brosse de toilette



SAHARA

Steinzeug / Stoneware / Object en terre cuite



100
Weiß



133
Basalt



202
Natur



443
Magnolie



685
Maledivia



11,3 cm
3,0 cm

5046 ... 853
Seifenschale
Soap dish
Porte-savon



10,8 cm

5046 ... 852
Zahnputzbecher
Tumbler
Gobelet de brosse à dents



36,5 cm

5046 ... 856
WC-Bürstengarnitur
Toilet brush holder
Porte-brosse de toilette



12,5 cm

5046 ... 849
Seifenspender Flakon
Bottle of Soap dispenser
Flacon distributeur de savon



18,0 cm

5046 ... 854
Seifenspender groß
Large soap dispenser
Grand distributeur de savon



SAVANNAH

Steinzeug / Stoneware / Object en terre cuite



43,0 cm

8637 ... 856
WC-Bürstengarnitur
Toilet brush holder
Porte-brosse de toilette



17,6 cm

8637 ... 854
Seifenspender
Soap dispenser
Distributeur de savon



913
Nebel



11,2 cm

8637 ... 852
Zahnputzbecher
Tumbler
Gobelet de brosse à dents

NEW



SARDINAS

Steinzeug / Stoneware / Object en terre cuite



783
Mare

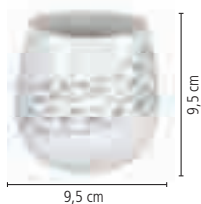

8674 ... 852
Zahnputzbecher
Tumbler
Gobelet de brosse à dents



8674 ... 854
Seifenspender
Soap dispenser
Dispenseur de savon



8674 ... 856
WC-Bürstengarnitur
Toilet brush holder
Porte-brosse de toilette

SERENA

Steinzeug / Stoneware / Object en terre cuite



415
Koralle



436
Beere



537
Solaris



685
Maledivia



8642 ... 856
WC-Bürstengarnitur
Toilet brush holder
Porte-brosse de toilette



8642 ... 854
Seifenspender
Soap dispenser
Dispenseur de savon



8642 ... 852
Zahnputzbecher
Tumbler
Gobelet de brosse à dents

SOAP

Glas / Glass / Verre



Seifenspender aus Glas
mit „PURE SOAP“ Prägung



926
Schwarz



8032 ... 854
Seifenspender
Soap dispenser
Dispenseur de savon

STONES

Polyresin



226
Sandbeige



912
Dunkelgrau

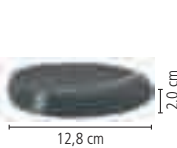

5080 ... 853
Seifenschale
Soap dish
Porte-savon



5080 ... 852
Zahnputzbecher
Tumbler
Gobelet de brosse à dents



5080 ... 854
Seifenspender
Soap dispenser
Dispenseur de savon



5080 ... 856
WC-Bürstengarnitur
Toilet brush holder
Porte-brosse de toilette



STREAM

TPR / Metall / PP



101
Chromfarbig

8490 ... 856
WC-Bürstengarnitur
Toilet brush holder
Porte-brosse de toilette



926
Schwarz

Ersatz-Bürstenkopf aus TPR

Brush head made of TPR
Tête de brosse en TPR

8490 926 868
Bürstenkopf
Replacement toilet brush head
Tête de rechange pour brosse



TIMBER

Polystyrol + Bambus / Polystyrol + bamboo / Polystyrol + bambou



*VE = 2 Stück



100
Weiß



5877 ... 856
WC-Bürstengarnitur
Toilet brush holder
Porte-brosse de toilette



***5877 ... 854**
Seifenspender
Soap dispenser
Dispenseur de savon



***5877 ... 852**
Zahnputzbecher
Tumbler
Gobelet de brosse à dents



***5877 ... 853**
Seifenschale
Soap dish
Porte-savon

Sensor-Seifenspender TOUCHLESS

Sensor soap dispenser / Distributeur de savon à capteur

ABS Kunststoff / ABS Plastic / ABS Plastique



- mit 3 Infrarotsensoren
- hygienisch und sparsam
- gummierte Oberfläche
- with 3 infrared sensors
- hygienic and economical
- gummed surface
- avec 3 capteurs infrarouges
- hygiénique et économique
- surface gommée

Einfaches Befüllen
Easy to fill
Remplissage facile



4x 1,5 V AAA LR 03

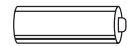

Nicht enthalten
Not included
Non inclus



926
Schwarz



8026 ... 854
Seifenspender
Soap dispenser
Dispenseur de savon

Füllmenge ca. 230 ml

Filling quantity approx. 230 ml

Quantité de remplissage environ 230 ml

Geeignet für Flüssigseife / Suitable for liquid soap / Convient pour le savon liquide

ERSATZTEILE PUMPENKÖPFE

SPARE PARTS Replacement pump head / PIÈCES DE RECHANGE Tête de rechange pour pompe

ACAIA

 8610 117 890
 CHROM

ADONA

 8672 124 890
 SCHWARZ

ALVA

 8095 926 890
 SCHWARZ

ANCHOR

 5876 124 890
 SILBER

ANTOINETTE

 8034 125 890
 GOLD

ARCO

 8641 124 890
 SILBER

ARGENTIC

 8470 124 890
 SILBER

BELLY

 8471 606 890
 OLIVGRÜN

BELLY

 8471 783 890
 MARE

BENTO

 8027 124 890
 SILBER

BLAZE

 8644 124 890
 SILBER

BONNY

 8035 926 890
 SCHWARZ

BOW

 8639 124 890
 SILBER

BRACE ECO RESIN

 8671 117 890
 CHROM

BREEZE

 8089 124 890
 SILBER

CONCHA

 8668 124 890
 SILBER

CRACKLE

 8430 124 890
 SILBER

CRINKLE

 8643 926 890
 SCHWARZ

CROSSOVER

 8094 100 890
 WEISS

CROSSOVER

 8094 926 890
 SCHWARZ

CUBIC

 5066 124 890
 SILBER

DASH

 8667 117 890
 CHROM

DOTTY

 8030 124 890
 SILBER

DRIP

 8088 226 890
 SANDBEIGE

DRIP

 8088 783 890
 MARE

DRIP

 8088 926 890
 SCHWARZ

EASY

 5061 124 890
 SILBER

ECLIPSE

 8036 124 890
 SILBER

FLASH

 5045 117 890
 CHROM

FORTUNE

 5058 124 890
 SILBER

GLAMOUR

 5065 124 890
 SILBER

GLAMOUR

 5065 125 890
 GOLD

GOLA

 8638 926 890
 SCHWARZ

GOLDEN CRACKLE

 8431 125 890
 GOLD

GROOVE

 8091 291 890
 BAST

GROOVE

 8091 314 890
 CAPPUCINO

GROOVE

 8091 398 890
 PEARL

KYOTO

 5079 117 890
 CHROM

LEAF

 8031 124 890
 SILBER

MABLE

 5841 124 890
 SILBER

MADERA

 8670 117 890
 CHROM

MARBLE

 5854 124 890
 SILBER

MARMOR

 8033 926 890
 SCHWARZ

MELUA

 8615 124 890
 SILBER

MERCURY

 5898 124 890
 SILBER

MOSS

 8669 117 890
 CHROM

NAVAGIO

 8666 124 890
 SILBER

OPALIS

 8673 124 890
 SILBER

PALM

 8092 124 890
 SILBER

PINO

 5059 124 890
 SILBER

PUR / PUR SHINY

 5055 124 890
 SILBER

PUR / PUR SHINY

 5055 124 891
 SILBER

RUNA

 8087 616 890
 DILL

RUNA

 8087 926 890
 SCHWARZ

SAHARA

 5046 117 890
 CHROM

SARDINAS

 8674 124 890
 SILBER

SAVANNAH

 8637 104 890
 SILBERGRAU

SERENA

 8642 124 890
 SILBER

SOAP

 8032 926 890
 SCHWARZ

STONES

 5080 117 890
 CHROM

TIMBER

 5877 124 890
 SILBER

ERSATZTEILE BÜRSTENKÖPFE UND BÜRSTEN

SPARE PARTS Toilet brush head and brushes / PIÈCES DE RECHANGE Tête de brosse et brosses

		Bürste Ø 7,3 cm Replacement brush Brosse de rechange 5047 926 870 Schwarz	Bürste Ø 7,3 cm Replacement brush Brosse de rechange 5047 117 870 Chrom	Bürste Ø 8,2 cm Replacement brush Brosse de rechange 5060 125 870 Gold	Bürste Ø 8,2 cm Replacement brush Brosse de rechange 5060 915 870 Black	Bürste Ø 8,2 cm Replacement brush Brosse de rechange 5060 926 870 Schwarz	Bürste Ø 8,2 cm Replacement brush Brosse de rechange 5060 117 870 Chrom	Bürstenkopf TPR Replacement toilet brush head Tête de rechange pour brosse 8490 926 868 Schwarz	Bürstenkopf Ø 7,3 cm Replacement toilet brush head Tête de rechange pour brosse 5877 926 868 Schwarz	Bürstenkopf Ø 6,2 cm Replacement toilet brush head Tête de rechange pour brosse 5841 185 868 Schwarz Weiß	Bürstenkopf Ø 7,3 cm Replacement toilet brush head Tête de rechange pour brosse 5047 926 868 Schwarz	Bürstenkopf Ø 7,3 cm Replacement toilet brush head Tête de rechange pour brosse 5047 185 868 Schwarz Weiß	Bürstenkopf Ø 8,2 cm Replacement toilet brush head Tête de rechange pour brosse 5060 926 868 Schwarz	Bürstenkopf Ø 8,2 cm Replacement toilet brush head Tête de rechange pour brosse 5060 185 868 Schwarz Weiß
8610	ACAIA					•	•						•	•
8672	ADONA	NEW				•	•						•	•
8095	ALVA				•								•	•
5876	ANCHOR					•	•						•	•
8470	ARGENTIC					•	•						•	•
8614	BELGRANO												•	•
8471	BELLY					•							•	
8027	BENTO					•	•						•	•
8644	BLAZE					•	•						•	•
8035	BONNY				•								•	•
8639	BOW					•	•						•	•
8671	BRACE	NEW				•	•						•	•
8089	BREEZE										•	•		
8668	CONCHA	NEW				•	•						•	•
8430	CRACKLE					•	•						•	•
8643	CRINKLE				•								•	•
8094	CROSSOVER												•	•
5066	CUBIC	•	•								•	•		
8667	DASH	NEW				•	•						•	•
8030	DOTTY					•	•						•	•
8088	DRIP					•	•						•	•
5061	EASY										•	•		
8036	ECLIPSE					•	•						•	•
5045	FLASH	•	•								•	•		
5058	FORTUNE					•	•						•	•
5065	GLAMOUR			•		•	•						•	•
8638	GOLA				•								•	•
8431	GOLDEN CRACKLE			•									•	•
8091	GROOVE					•	•						•	•
5079	KYOTO										•	•		
8031	LEAF					•	•						•	•
5841	MABLE									•				
5854	MARBLE					•	•						•	•
8033	MARMOR				•								•	•
8615	MELUA					•	•						•	•
5898	MERCURY					•	•						•	•
8669	MOSS					•	•						•	•
8666	NAVAGIO	NEW				•	•						•	•
8673	OPALIS	NEW	•	•							•	•		
8092	PALM	NEW				•	•						•	•
5055	PUR					•	•						•	•
5084	PUR SHINY					•	•						•	•
8087	RUNA				•								•	•
5046	SAHARA	•	•								•	•		
8674	SARDINAS					•	•						•	•
8637	SAVANNAH	NEW				•	•						•	•
8642	SERENA					•	•						•	•
5080	STONES	•	•								•	•		
8490	STREAM							•						
5877	TIMBER								•					

Badorganisation

Bath organisation

Organisation pour la salle de bain



ÜBERSICHT

Content / Contenu



CLAP

CLAP
CLAP MINI
GOLDEN CLAP
GLOSSY
SILENCE

170
170
170
171
171



SILENCE

SEITE 170-171

Kosmetikeimer
cosmetic bins
poubelles à cosmétiques



ASPERA 172
BEDFORD 172
BRAVA 173
CHEVRON 173
CHICO BOX 173
DASH TRAY 174
DOUBLE BOX 174
FELLONE 174
GODONA 175
PATCH 175
PUNTA 176
SLACK 176
SUEDE 176
CASSONE 177
CRACKLE JAR 177
ROLL HOLDER 177
TISSUE 177
TREASURE 178
TRINKET 178



SEITE 172-182

Badorganisation
bath organisation
organisation pour la salle de bain

BALLOT 178
POLYGON 178
DOUBLE LAUNDRY BOX 179
WÄSCHEBOY 179
LEVANA 180
ROCCO 181
LEONA 182
PURO 182
SONO 182
LINDO 182

SEITE 183-189

Haken
wall hooks
crochets muraux

BASIC HOOKS 183
BRINKLE HOOKS 183
CLASSIC HOOKS 183
CRAZY HOOKS 184
JOLLY HOOKS 184
DOOR HOOKS 185
EASY HOOKS 186
MARBLE HOOKS 186
METAL HOOKS 186
MIRA HOOKS 187
MIRROR HOOKS 187
ONA HOOKS 187



TULIP HOOK



TRIPLE TULIP HOOK

SMART HOOKS 188
SQUARE HOOKS 188
STATIC HOOKS 188
TIMBER HOOKS 189
TULIP HOOKS 189
TRIPLE TULIP HOOKS 189

CLAP / CLAP MINI / GOLDEN CLAP

ABS Kunststoff
ABS Plastic
ABS Plastique

Schwingdeckeleimer

Swing bin
Poubelle à couvercle
basculant



CLAP

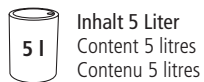

Inhalt 5 Liter
Content 5 litres
Contenu 5 litres

5829 ... 858
ca. 19 x 24,5 cm



114
Schneeweiß



202
Natur



443
Magnolie



537
Solaris



612
Forest



685
Maledivia



926
Schwarz



977
Platin

Dank des praktischen Schwingdeckels
sind Abfälle schnell verschwunden.

Rubbish disappears quickly thanks to
the convenient swing lid.

Le couvercle à bascule pratique permet
de jeter rapidement les déchets.



CLAP MINI

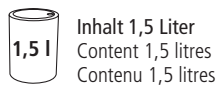

Inhalt 1,5 Liter
Content 1,5 litres
Contenu 1,5 litres

8415 ... 858
ca. 12,8 x 16,2 cm



114
Schneeweiß



977
Platin

GOLDEN CLAP



Inhalt 5 Liter

8418 ... 858
ca. 19 x 24,5 cm



926
Schwarz

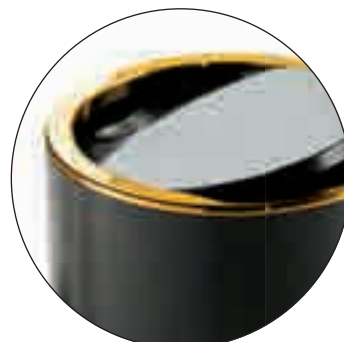

Die Goldeinfassung macht den
Kosmetikeimer zum edlen Hingucker

The golden rim makes the cosmetic bin a
sophisticated eye-catcher

La bordure dorée fait du seau à cosmétique
un accroche-regard raffiné



GLOSSY

Polypropylen



115
Polarweiß

291
Bast



616
Dill



901
Anthrazit

Schwingdeckeleimer

Swing bin
Poubelle à couvercle
basculant



Inhalt 5 Liter
Content 5 litres
Contenu 5 litres

5063 ... 858
ca. 20 x 30 cm
VE = 2 Stück



SILENCE

Metall / Metal / Métal

Treteimer
Pedal bin
Poubelle à pédale

Mit praktischem Griff und
herausnehmbarem Innenbehälter

With practical handle and
removable inner container
Avec poignée pratique et
réceptier intérieur amovible



100
Weiß



101
Chromfarbig



226
Sandbeige



301
Nussbraun



407
Old Rose



436
Beere



685
Maledivia



783
Mare



851
Lavendel



926
Schwarz



977
Platin



Inhalt 3 Liter
Content 3 litres
Contenu 3 litres

8419 ... 858
ca. 17 x 23,6 cm

ASPERA

Polypropylen

Box



8651 ... 060
Box M
ca. 18,5 x 12,0 x 28,0 cm



100
Weiß



226
Sandbeige



301
Nussbraun



304
Terracotta



312
Platine



431
Rouge



685
Maledivia



783
Mare



851
Lavendel



852
Erika



926
Schwarz



977
Platin

BEDFORD

Polyester

Korb

Basket
Panier



8650 ... 059
Korb S
ca. 17,0 x 11,5 x 22,0 cm



201
Beige



783
Mare



977
Platin



8650 ... 060
Korb M
ca. 23,0 x 11,0 x 23,0 cm



201
Beige



783
Mare



977
Platin



BRAVA

Polypropylen

Box



VE = 4 Stück / 4 pieces / 4 unités

5862 ... 060

Box M

ca. 21,5 x 9,5 x 11,0 cm



100
Weiß



606
Olivgrün



783
Mare



977
Platin

CHEVRON

Polypropylen

Box

Bi-Color-Effekt
schwarz-weiß

Bi-Color effect black and white
Effet bicolore noir et blanc



185
Schwarz-Weiß

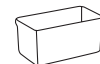

VE = 2 Stück / 2 pieces / 2 unités

8047 ... 059

Box S

ca. 22,0 x 9,0 x 14,0 cm

CHICO

Polypropylen

Box



VE = 2 Stück / 2 pieces / 2 unités

5889 ... 059

Box S

ca. 22,0 x 7,0 x 14,0 cm



VE = 2 Stück / 2 pieces / 2 unités

5889 ... 060

Box M

ca. 24,0 x 9,0 x 18,5 cm

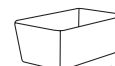

VE = 2 Stück / 2 pieces / 2 unités

5889 ... 061

Box L

ca. 28,0 x 11,5 x 18,0 cm



100
Weiß



202
Natur



901
Anthrazit

DASH TRAY

Bambus / Bamboo / Bambou



Dekoschale
Decorative tray
Plateau décoratif



202
Natur



8675 ... 885
ca. 27,5 x 11,0 x 1,5 cm

Ideal auch zur Deko
mit Kleine Wolke Accessoires

Also ideal for decorating
with Kleine Wolke accessories
Idéal pour décorer avec
des accessoires Kleine Wolke



DOUBLE BOX

Polypropylen

Box



VE = 2 Stück / 2 pieces / 2 unités
5880 ... 060
Box M
ca. 20,0 x 12,0 x 16,5 cm

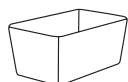

VE = 2 Stück / 2 pieces / 2 unités
5880 ... 061
Box L
ca. 33,0 x 17,0 x 23,0 cm



202
Natur



977
Platin

FELLONE

Polyester / Baumwolle / Viskose
Polyester / Cotton / Viscose
Polyester / Coton / Viscose

Korb
Basket
Panier



8605 ... 060
ca. 14,0 x 10,0 x 19,0 cm



202
Natur



926
Schwarz





GODONA

Baumwolle / Cotton / Cotone

Korb / Basket / Panier



8652 ... 059
ca. 19,0 x 19,0 x 19,0 cm



226
Sandbeige



401
Nelke



685
Maledivia

PATCH

Polyester / Baumwolle / Viskose
Polyester / Cotton / Viscose
Polyester / Coton / Viscose

Korb
Basket / Panier

Flexible Körbe zur Aufbewahrung von
Badaccessoires

Flexible baskets for storing bathroom supplies
Paniers flexibles pour le rangement
des accessoires de bain



270
Bahamabeige



926
Schwarz



8649 ... 059
Korb S
ca. 19,5 x 16,5 x 19,0 cm



270
Bahamabeige



926
Schwarz

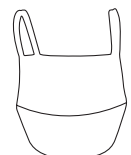

8649 ... 062
Korb XL
ca. 30,0 x 34,5 x 30,0 cm

PUNTA

Polyester / Baumwolle / Viskose
Polyester / Cotton / Viscose
Polyester / Coton / Viscose

Korb

Basket / Panier



8606 ... 060
ca. 19,0 x 10,0 x 19,0 cm



401
Nelke

698
Eucalyptus



SLACK

Metall / Metal / Métal

Drahtkorb

Wire basket
Panier en fil métallique

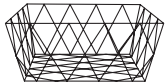

8604 ... 060
ca. 28,0 x 12,0 x 19,0 cm

926
Schwarz

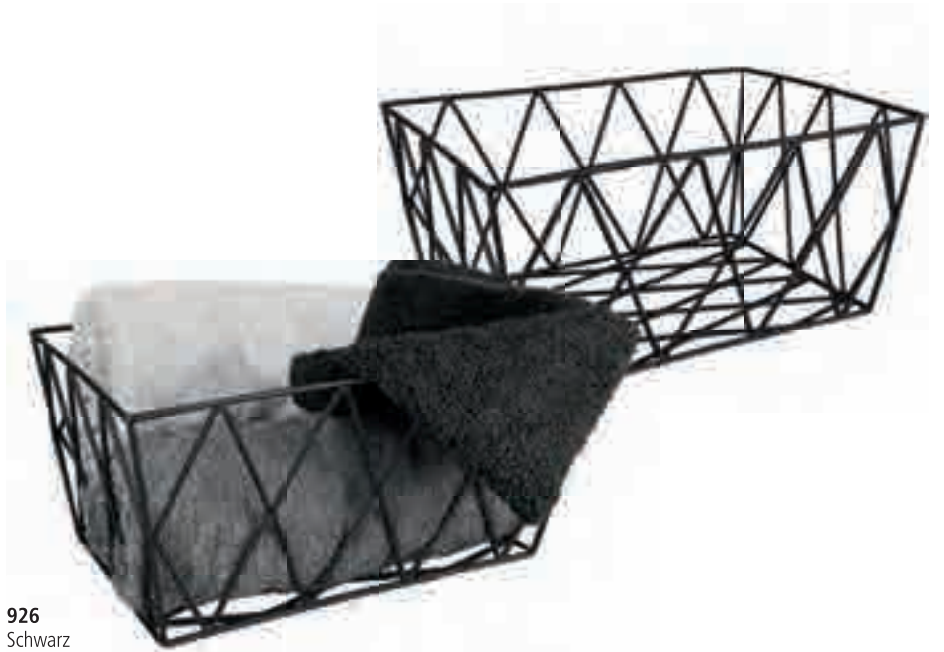

SUEDE

Polyester

Aufbewahrungsbox in Wildleder-Imitat

Storage box
in imitation suede
Boîte de rangement
en imitation daim

mit praktischen Grifföchern

with practical grip holes
avec trous de poignée pratiques

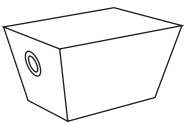

8607 ... 060
ca. 27,0 x 15,0 x 20,0 cm



291
Bast



342
Brasil



783
Mare

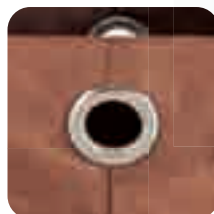

CASSONE

Metall + Bambus
Metal + Bamboo
Métal + Bambou

Metallbox mit Bambusdeckel
Metal box with bamboo lid
Boîte en métal avec couvercle en bambou



8608 ... 060
ca. 11,0 x 14,0 cm



100
Weiß



926
Schwarz

CRACKLE JAR

Polyresin

Das passt dazu:

CRACKLE
Accessoire-Serie
> Seite 124



Dose mit Deckel
Container with lid
Bocal et couvercle



100
Weiß



226
Sandbeige



685
Maledivia



783
Mare



926
Schwarz



977
Platin



8046 ... 873
ca. 10,5 x 6,0 cm

ROLL HOLDER

Metall / Metal / Métal

Ersatzrollenhalter
Toilet paper roll holder
Porte-rouleau de rechange



124
Silber

8613 ... 826
ca. 14,0 x 56,0 x 14,0 cm



TISSUE

Polyresin

Box

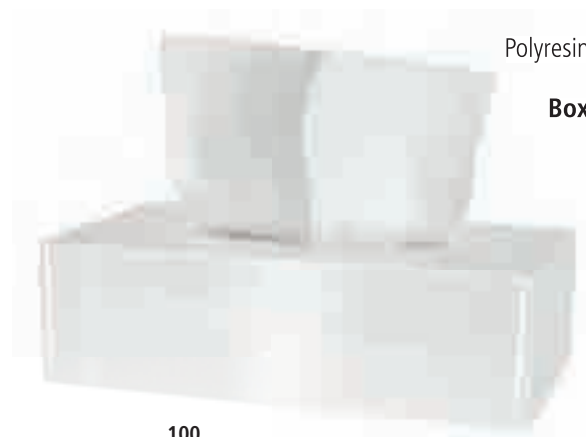

100
Weiß



8044 ... 060
ca. 13,5 x 11,3 x 25,0 cm

TREASURE

Metall beschichtet
Metal coated
Revêtement en métal

Box

Kosmetik und Zubehör lassen
sich perfekt organisieren
Organise cosmetics and accessories perfectly
Vous rangerez en toute simplicité vos
cosmétiques et vos accessoires

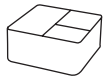

8647 ... 060
ca. 13,9 x 13,9 x 6,4 cm



926
Schwarz

TRINKET

Metall / Metal / Métal

Schmuckhalter
Jewellery holder
Pour les bijoux



8648 ... 060
ca. 18,0 x 25,0 x 10,0 cm



926
Schwarz

BALLOT

Metall + Glas / Metal + Glass / Métal + Verre

Windlicht mit Glaseinsatz
Lantern with glass insert
Lanterne avec insert en verre

8603 ... 060
ca. 14,8 x 15,2 cm



926
Schwarz

POLYGON

Metall + Glas / Metal + Glass / Métal + Verre

Windlicht mit Glaseinsatz
Lantern with glass insert
Lanterne avec insert en verre

8602 ... 060
ca. 12,0 x 12,2 x 12,0 cm



926
Schwarz

DOUBLE LAUNDRY BOX

Polypropylen

Wäschebox
Laundry box
Box à linge



202
Natur

977
Platin



8406 ... 860
Laundry Box
ca. 35,0 x 55,0 x 35,0 cm

WÄSCHEBOY

Polypropylen gewebt

Wäschebox
Laundry box
Box à linge



Gewebte Oberfläche
Woven surface
Surface tissée



100
Weiß



948
Graphit

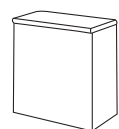

5067 ... 860
ca. 48,0 x 55,0 x 27,0 cm

LEVANA

Metall chromiert / Metal chrome plated / Métal chromé

TURN + **FIX**

VAKUUM SAUGNAPF-SYSTEM

- durch Drehen des Adapters wird ein Vakuum erzeugt
- nach dem Fixieren direkt belastbar
- beliebig oft neu positionierbar
- rückstandsfrei ablösbar

VACUUM SUCTION CUP SYSTEM

- by turning the adapter a vacuum is created
- can be loaded directly after fixing
- repositionable as often as required
- removable without residue

SYSTÈME DE VENTOUSE À DÉPRESSION

- Fixation par système de dépression
- Peut être utilisé immédiatement après a fixation
- Repositionner aussi souvent que souhaité
- Amovible sans résidus



124
Silber

3 kg

13,5 x 7 x 12 cm (B x H x T)

8059 ... 802
Seifenablage
Soap dish
Porte-savon



124
Silber

6 kg

23,5 x 12 x 7,8 cm (B x H x T)

8059 ... 803
Korb rechteckig
Basket rectangular
Panier rectangulaire

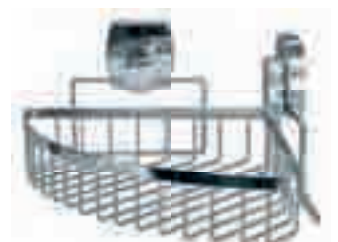

124
Silber

6 kg

29,5 x 7,5 x 20,5 cm (B x H x T)

8059 ... 804
Korb dreieckig
Basket triangular
Panier triangulaire



124
Silber

6 kg

26 x 42,3 x 12,5 cm (B x H x T)

8059 ... 806
Doppelkorb rechteckig
Double basket rectangular
Panier double rectangulaire



124
Silber

6 kg

27,3 x 31,5 x 21 cm (B x H x T)

8059 ... 807
Doppelkorb dreieckig
Double basket triangular
Panier double triangulaire

QUICK + FIX

KLEBEN STATT BOHREN

- ▶ einfache und schnelle Montage durch Klebepad auf der Rückseite
- ▶ zuverlässiger und starker Halt
- ▶ anwendbar auf vielen Oberflächen
- ▶ wasserfest

GLUING INSTEAD OF DRILLING

- Adhesive pads on the back for quick and easy mounting
- reliable and strong hold
- applicable to many surfaces
- waterproof

COLLER AU LIEU DE PERCER

- Installation facile et rapide grâce à la surface
- Adhérence forte et fiable
- Applicable sur de nombreuses surfaces
- Résistant à l'humidité



926
Schwarz



928
Aluminium



14 x 3,7 x 11,4 cm (B x H x T)

8061 ... 802
Seifenablage
Soap dish
Porte-savon



926
Schwarz



928
Aluminium



18,5 x 7 x 14 cm (B x H x T)

8061 ... 803
Korb rechteckig
Basket rectangular
Panier rectangulaire



926
Schwarz



928
Aluminium



26 x 35,5 x 13,5 cm (B x H x T)

8061 ... 806
Doppelkorb rechteckig
Double basket rectangular
Panier double rectangulaire



926
Schwarz



928
Aluminium



25,4 x 4,5 x 13,5 cm (B x H x T)

8061 ... 806
Doppelkorb rechteckig
Double basket rectangular
Panier double rectangulaire



926
Schwarz



928
Aluminium



26 x 35,5 x 13,5 cm (B x H x T)

8061 ... 806
Doppelkorb rechteckig
Double basket rectangular
Panier double rectangulaire

LEONA

Metall chromiert / Metal chrome plated / Métal chromé



124
Silber



Mit gummierten Aufhängern
With rubberised hangers
Avec cintres caoutchoutés



25 x 60 x 11 cm (B x H x T)

8060 ... 806
Duschwand-Doppelkorb
Over shower double basket
Cloison de douche à double panier

DUSCHABZIEHER

Shower wiper / Ra-
clette de douche

PURO

Edelstahl / EVA
Stainless steel / EVA
Acier inoxydable
/ EVA



124
Silber

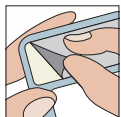

Statisch haftend
Static hold
Fixation statique

24,2 x 18 x 2,5 cm (B x H x T)

8064 ... 060
Duschabzieher
Shower wiper
Raclette de douche

SONO

Edelstahl / Silikon
Stainless steel /
Silicone
Acier inoxydable /
Silicone



124
Silber



26 x 28,5 x 3 cm (B x H x T)

8066 ... 060
Duschabzieher
Shower wiper
Raclette de douche

LINDO

Polypropylen
Polypropylene
Polypropylène

Mit Saugnapf
With suction cup
Avec ventouse



100
Weiß

926
Schwarz

22 x 23 x 3 cm (B x H x T)

8063 ... 060
Duschabzieher
Shower wiper
Raclette de douche

BASIC HOOKS

Edelstahl
Stainless steel
Acier inoxydable



Wandhaken

- hohe Klebekraft
- einfach anzubringen

Wall hooks

- high adhesive power
- easy to install

Crochet mural

- résistance élevée
- fixation facile sans percer

Quadratic Basic Hooks

8654... 887
ca. 5,1 x 6,7 cm
2 Stck. / 2 pieces / 2 pièces

Quadratic Basic Hooks

8655 ... 887
ca. 5,0 x 7,1 cm
2 Stck. / 2 pieces / 2 pièces

117
Chrom

BRINKLE HOOKS

Polyresin

Wandhaken

- hohe Klebekraft
- einfach anzubringen

Wall hooks

- high adhesive power
- easy to install

Crochet mural

- résistance élevée
- fixation facile sans percer



100
Weiß



685
Maledivia



926
Schwarz



977
Platin

8055 ... 887
ca. 5,0 x 5,0 cm

VE = 4 Stück / 4 pieces / 4 unités

CLASSIC HOOKS

Edelstahl
Stainless steel
Acier inoxydable



Wandhaken

- hohe Klebekraft
- einfach anzubringen

Wall hooks

- high adhesive power
- easy to install

Crochet mural

- résistance élevée
- fixation facile sans percer

Fondo

8050 ... 887
ca. 4,5 x 4,5 cm
VE = 4 Stück / 4 pieces / 4 unités

Iseo

8049 ... 887
ca. 4,5 x 4,5 cm
VE = 4 Stück / 4 pieces / 4 unités

117
Chrom

CRAZY HOOKS

Polystyrol

Saughaken

- hohe Saugkraft
- einfach anzubringen
- weltweit patentiert

Suction hooks

- high suction power
- easy to install
- universally patented

Crochet à ventouse

- résistance élevée
- fixation facile sans percer
- brevet international

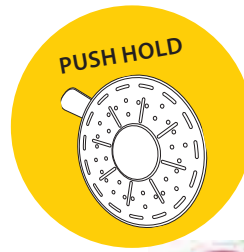

463
Cassis

488
Orange

657
Tanne



766
Türkis

Baby Bird

5069 ... 887
ca. 7,0 x 6,3 cm

VE = 4 Stück / 4 pieces / 4 unités



463
Cassis

488
Orange

657
Tanne



766
Türkis

Butterfly Lisa

5068 ... 887
ca. 7,1 x 7,5 cm

VE = 4 Stück / 4 pieces / 4 unités

JOLLY HOOKS

AS / ABS Kunststoff
AS/ABS Plastic
AS/ABS Plastique

Wandhaken

- hohe Klebekraft
- einfach anzubringen

Wall hooks

- high adhesive power
- easy to install

Crochet mural

- résistance élevée
- fixation facile sans percer



100
Weiß

Jolly Bird

8052 ... 887
ca. 7,3 x 7,0 cm

VE = 4 Stück / 4 pieces / 4 unités



685
Maledivia



977
Platin



685
Maledivia

Jolly Butterfly

8054 ... 887
ca. 8,1 x 6,9 cm

VE = 4 Stück / 4 pieces / 4 unités



977
Platin



100
Weiß

Jolly Cat

8053... 887
ca. 8,3 x 4,8 cm

VE = 4 Stück / 4 pieces / 4 unités



685
Maledivia



977
Platin

DOOR HOOKS 19 mm

Edelstahl / Stainless steel / Acier inoxydable

Türhaken
Door hooks
Crochets de porte

Ohne Schrauben oder Bohren. Für fast alle Türen bis zu 19 mm Falzstärke geeignet
No screws or drilling required. Suitable for almost all doors with a thickness of up to 19mm.
Sans perceuse ni vis. Compatible avec pratiquement toutes les portes d'une épaisseur de rainure max. de 19 mm.

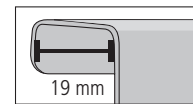

Single Door Hooks
2 Stück / 2 pieces / 2 unités



117
Chrom

8420 117 846
ca. 2,0 x 7,8 x 4,5 cm
VE = 4 x 2 Stück
4 x 2 pieces / 4 x 2 unités



Double Door Hooks



117
Chrom

8421 117 846
ca. 6,8 x 6,2 x 4,7 cm
VE = 4 Stück
4 pieces / 4 unités



Climber Door Hooks



117
Chrom

8422 117 846
ca. 4,6 x 5,0 x 4,3 cm
VE = 4 Stück
4 pieces / 4 unités

DOOR HOOKS 41 mm

Edelstahl / Stainless steel / Acier inoxydable

Türhaken
Door hooks
Crochets de porte

Ohne Schrauben oder Bohren.
Für fast alle Türen bis zu 41 mm Falzstärke geeignet.
No screws or drilling required. Suitable for almost all doors with a thickness of up to 41 mm.
Sans perceuse ni vis. Compatible avec pratiquement toutes les portes d'une épaisseur de rainure max. de 41 mm.

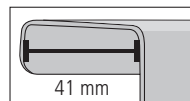

Twin Door Hooks



100
Weiß

8600 100 846
ca. 12,5 x 10,7 cm



Strip Door Hooks



100
Weiß

8601 100 846
ca. 34,8 x 10,7 cm

EASY HOOKS

AS Kunststoff
AS Plastic
AS Plastique

Saughaken

- hohe Saugkraft
- einfach anzubringen
- weltweit patentiert

Suction hooks

- high suction power
- easy to install
- universally patented

Crochet à ventouse

- résistance élevée
- fixation facile sans percer
- brevet international



114
Schneeweiß



926
Schwarz

5093 ... 887
ca. 5,5 x 7,5 cm
VE = 4 Stück / 4 pieces / 4 unités



MARBLE HOOKS

Marmor + Zink
Marble + Zinc
Marbre + Zinc

Wandhaken

- hohe Klebekraft
- einfach anzubringen

Wall hooks

- high adhesive power
- easy to install

Crochet mural

- résistance élevée
- fixation facile sans percer



100
Weiß

8405 ... 887
Ø ca. 5,0 cm
VE = 4 Stück / 4 pieces / 4 unités



METAL HOOKS

Edelstahl
Stainless steel
Acier inoxydable

Wandhaken

- hohe Klebekraft
- einfach anzubringen

Wall hooks

- high adhesive power
- easy to install

Crochet mural

- résistance élevée
- fixation facile sans percer



117
Chrom

Star, 2 Stück

5811 ... 887
ca. 6,5 x 6,5 cm
VE = 4 x 2 Stück
4 x 2 pieces / 4 x 2 unités



117
Chrom

Hoppy 2 Stück

5812 ... 887
ca. 4,0 x 8,5 cm
VE = 4 x 2 Stück
4 x 2 pieces / 4 x 2 unités





MIRA HOOKS

Wandhaken

- hohe Klebekraft
- einfach anzubringen

ABS / Glas
ABS / Glass
ABS / Verre

Wall hooks

- high adhesive power
- easy to install

Crochet mural

- résistance élevée
- fixation facile sans percer



8051 ... 887

ca. 7,4 x 12,7 cm

VE = 4 Stück / 4 pieces / 4 unités

100
Weiß



MIRROR HOOKS

Wandhaken

- hohe Klebekraft
- einfach anzubringen

Acryl
Acrylic
Acrylique

Wall hooks

- high adhesive power
- easy to install

Crochet mural

- résistance élevée
- fixation facile sans percer



5856 ... 887

ca. 5,0 x 5,0 cm

VE = 4 Stück / 4 pieces / 4 unités

124
Silber

Mit Häckseln aus
nachwachsendem Bambus

With chaff from renewable bamboo
Avec de la paille de bambou renouvelable

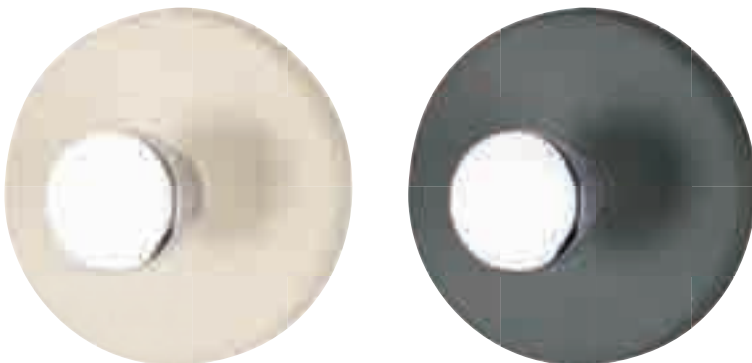

ONA HOOKS

Wandhaken

- hohe Klebekraft
- einfach anzubringen

Bambus + Melamin + Zink
Bamboo + Melamine + Zinc
Bambou + Mélatine + Zinc

Wall hooks

- high adhesive power
- easy to install

Crochet mural

- résistance élevée
- fixation facile sans percer



Im Verkaufsdisplay, sortiert:
6 x Sandbeige / 6 x Schiefer

In sales display, assorted:
6 x sand beige / 6 x slate

Dans les rayonnages, tri :
6 x beige sable / 6 x ardoise

8616 ... 887

ca. 5,0 x 5,0 cm

Sortiert / Assorted / Trié

SMART HOOKS

Zink / PVC
Zinc / PVC

Saughaken

- hohe Saugkraft
- einfach anzubringen
- weltweit patentiert

Suction hooks
Crochet à ventouse



124
Silber
VE = 4 Stück
4 pieces / 4 unités

Cordoba
5089 ... 887
ca. Ø 6,8 cm

Granada
5088 ... 887
ca. Ø 6,8 cm

Marbella
5086 ... 887
ca. Ø 6,8 cm

Sevilla
5087 ... 887
ca. Ø 6,8 cm

SQUARE HOOKS

Acryl / Acrylic / Acrylique

Wandhaken

- hohe Klebekraft
- einfach anzubringen

Wall hooks

- high adhesive power
- easy to install

Crochet mural

- résistance élevée
- fixation facile sans percer



114
Schneeweiß

926
Schwarz

5857 ... 887
ca. 5,0 x 5,0 cm

VE = 4 Stück
4 pieces / 4 unités



STATIC HOOKS

Statisch haftend Statically adherent / Collage statique

Kunststoff
Plastic
Plastique

Wandhaken

- wiederverwendbar
- leicht abziehbar
- geeignet für alle glatten Oberflächen

Wall hooks
Crochet mural



Butterflies
8410 ... 887
ca. Ø 7,7 cm
VE = 4 Stück
4 pieces / 4 unités

148
Multicolor



Transparent
8417 ... 887
ca. Ø 7,7 cm
VE = 4 Stück
4 pieces / 4 unités



116
Clear

Chrome
8416 ... 887
ca. Ø 7,7 cm
VE = 4 Stück
4 pieces / 4 unités

101
Chromfarbig

TIMBER HOOKS

Bambus / Bamboo / Bambou



Wandhaken

- hohe Klebekraft
- einfach anzubringen

Wall hooks

- high adhesive power
- easy to install

Crochet mural

- résistance élevée
- fixation facile sans percer



202
Natur

5879 ... 887
ca. 5,0 x 5,0 cm

VE = 4 Stück / 4 pieces / 4 unités

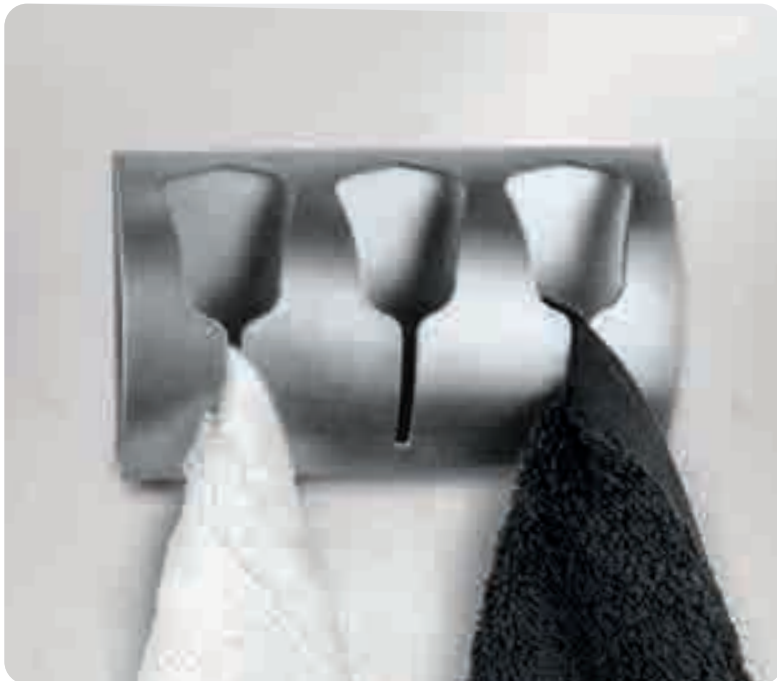

TRIPLE TULIP HOOKS

Klassischer Klemmhaken in zeitlosen Design

- Klebepad auf der Rückseite
- hohe Klebekraft
- einfach anzubringen

Classic clamping hook in a timeless design

- adhesive pads on the back
- high adhesion
- easy to install

Des crochets classiques au design intemporel

- Surface adhésive à l'arrière
- Grande force adhésive
- Facile à installer



117
Chrom

Edelstahl /
Stainless steel /
Acier inoxydable



926
Schwarz

Metall /
Metal / Métal

8645 ... 887
ca. 13,0 x 7,5 x 2,6 cm



TULIP HOOKS

Klassischer Klemmhaken in zeitlosen Design

- Klebepad auf der Rückseite
- hohe Klebekraft
- einfach anzubringen

Classic clamping hook in a timeless design

- adhesive pads on the back
- high adhesion
- easy to install

Des crochets classiques au design intemporel

- Surface adhésive à l'arrière
- Grande force adhésive
- Facile à installer



117
Chrom

Edelstahl /
Stainless steel /
Acier inoxydable



926
Schwarz

Metall /
Metal / Métal

8646 ... 887
ca. 5,0 x 7,5 x 2,3 cm

Kosmetikspiegel

Cosmetic mirror

Miroir de maquillage



SEITE 192-195 STANDSPIEGEL

Standing mirror page / Miroir sur pied page



BASE MIRROR 192



BRIGHT MIRROR 192



BRIGHT MIRROR BLACK 192



BRIGHT MIRROR SHORTY 192



CLEAR MIRROR 193



CLEVER MIRROR 193

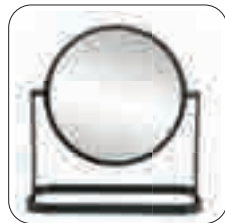

FRAMEWORK MIRROR 193



MULTI MIRROR 194



TIMBER MIRROR 194



TRANSPARENT MIRROR 194



TRAY MIRROR 195

SEITE 195-199 WANDSPIEGEL

Wall mirror page / Miroir mural page



BLADE MIRROR 195



BRILLIANT MIRROR 196



EASY MIRROR 196



FLEXY COLOR 196



FLEXY CUBE 197



FLEXY LIGHT 197



FLEXY MAX 197



LUMI MIRROR 198



MINI MIRROR 198



MOVE MIRROR 198



RIDGE MIRROR 199



ROPE MIRROR 199

BASE MIRROR

Metall chromiert + Glas / Chrome-plated metal + glass / Métal chromé + verre

Kosmetikspiegel

- 1-/5-fache Vergrößerung
- verchromt glänzend
- stabiler Standfuß

Cosmetic mirror

- 1-/5-fold enlargement
- chromed shinny
- stable case

Miroir de maquillage

- grossissement 1/5
- chromé brillant
- pied stable



886 Kosmetikspiegel
ca. 17,0 x 33,0 x 12,0 cm

8424 124 886
BASE MIRROR / 124 SILBER

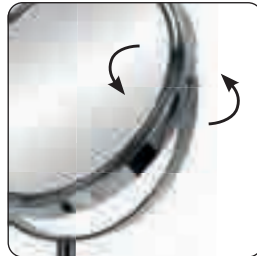

Schwenkbarer Spiegel
zum Wechsel der
Vergrößerungen

Swiveling mirror for changing
the enlargements.
Miroir pivotant pour changer
les élargissements.



BRIGHT MIRROR

Metall chromiert + Glas /
Chrome-plated metal + glass /
Métal chromé + verre

LED-Kosmetikspiegel

- 1-/5-fache Vergrößerung
- mit Chrom-Standfuß
- mit LED-Beleuchtung
- Batteriebetrieb

LED-Cosmetic mirror

- 1-/5-fold enlargement
- with chrome base
- with LED lights
- Battery powered

LED-Miroir de maquillage

- grossissement 1/5
- avec pied en chrome
- avec éclairage LED
- Fonctionne avec des piles



Schwenkbarer Spiegel
zum Wechsel der
Vergrößerungen

Swiveling mirror for changing
the enlargements.
Miroir pivotant pour changer
les élargissements.



886 Kosmetikspiegel
ca. 17,5 x 29,5 x 12,0 cm

5887 124 886
BRIGHT MIRROR / 124 SILBER

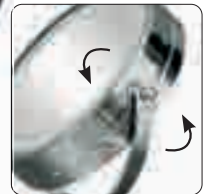

886 Kosmetikspiegel
ca. 17,5 x 29,5 x 12,0 cm

5887 926 886
BRIGHT MIRROR / 926 SCHWARZ

BRIGHT MIRROR SHORTY

Metall chromiert + Glas / Chrome-plated metal + glass / Métal chromé + verre

LED-Kosmetikspiegel

- 1-/5-fache Vergrößerung
- mit LED-Beleuchtung
- Batteriebetrieb

LED-Cosmetic mirror

- 1-/5-fold enlargement
- with LED lights
- Battery powered

LED-Miroir de maquillage

- grossissement 1/5
- avec éclairage LED
- Fonctionne avec des piles



886 Kosmetikspiegel
ca. 20,0 x 19,5 x 4,0 cm

5886 124 886
BRIGHT MIRROR SHORTY / 124 SILBER



CLEAR MIRROR

Polystyrol + Glas / Glass / Verre



x 1 / x 10
Ø 15,0 cm



Kosmetikspiegel

- 1-/10-fache Vergrößerung
- mit transparentem Rahmen und Standfuß

Cosmetic mirror

- 1x/10x magnification
- transparent frame and stand

Miroir de maquillage

- Grossissement x1/x10
- avec cadre transparent et support

886 Kosmetikspiegel
ca. 18,8 x 20,0 x 4,9 cm

8097 116 886
CLEAR MIRROR / 116 CLEAR

CLEVER MIRROR

Bambus + Glas / Bamboo + glass / Bambou + verre



Der clevere Wand- oder Standspiegel

The cosmetic mirror can be used either hanging or standing mirror.
Le miroir intelligent à accrocher et à poser.

x 1
15,0 x 21,0 cm



Kosmetikspiegel

- mit Bambus-Rückseite
- zum Hängen oder Stellen
- einfach zu transportieren

Cosmetic mirror

- reverse side made of bamboo
- can be used as either hanging or standing mirror
- easy to carry

Miroir de maquillage

- avec arrière en bambou
- à accrocher et à poser
- simple à transporter

886 Kosmetikspiegel
ca. 15,0 x 21,0 x 1,5 cm

5883 202 886
CLEVER MIRROR / 202 NATUR

FRAMEWORK MIRROR

Metall + Glas / Metal + glass / Métal + verre



x 1 / x 2
Ø 15,0 cm



Kosmetikspiegel

- 1-/2-fache Vergrößerung

Cosmetic mirror

- 1x/2x magnification

Miroir de maquillage

- Grossissement x1/x2

886 Kosmetikspiegel
ca. 17,5 x 9,5 x 8,0 cm

8042 926 886
FRAMEWORK MIRROR / 926 SCHWARZ

MULTI MIRROR

Polystyrol + Glas / Polystyrene + glass / Polystyrène + verre

Kosmetikspiegel

- multifunktional
- zusammenklappbar zum Verstauen
- ideal für die Reise

Cosmetic mirror

- multi-functional
- collapsible for compact storage
- ideal for travel

Miroir de maquillage

- multifonctionnelle
- Pliable pour un rangement facilité
- idéale en voyage



886 Kosmetikspiegel
ca. 13,8 x 24,5 x 1,2 cm

5840 116 886
MULTI MIRROR / 116 CLEAR



TIMBER MIRROR

Bambus + Metall chromiert + Glas /
Bamboo + chrome-plated metal + glass / Bambou + métal chromé + verre

Kosmetikspiegel

- mit Bambus-Standfuß
- mit praktischem Fach für Schmuck, Kosmetik, etc.

Cosmetic mirror

- bamboo base
- useful compartment for jewellery, make-up etc.

Miroir de maquillage

- avec pied en bambou
- avec compartiment pratique pour les bijoux, produits cosmétiques etc.



886 Kosmetikspiegel
ca. 17,0 x 30,5 x 14,0 cm

5884 202 886
TIMBER MIRROR / 202 NATUR



TRANSPARENT MIRROR

Polystyrol + Metall chromiert + Glas
Polystyrene + chrome-plated metal + glass / Polystyrène + métal chromé + verre

Kosmetikspiegel

- 1-/5-fache Vergrößerung
- mit Chrom-Standfuß
- mit transparentem Rahmen

Cosmetic mirror

- 1-/5-fold enlargement
- with chrome baser
- with transparent frame

Miroir de maquillage

- grossissement x1/x5
- avec pied en chrome
- avec cadre transparent



886 Kosmetikspiegel
ca. 20,0 x 34,5 x 15,0 cm

5885 116 886
TRANSPARENT MIRROR / 116 CLEAR



Schwenkbarer Spiegel zum Wechsel der Vergrößerungen.

Swiveling mirror for changing the enlargements.

Miroir pivotant pour changer les élargissements.



TRAY MIRROR

Polyresin + Glas / Polyresin + glass / Polyresin + verre



Kosmetikspiegel

- quer und hochkant nutzbar
- mit praktischer Ablage für Schmuck, Kosmetik etc.

Cosmetic mirror

- can be used horizontally and vertically
- useful compartment for jewellery, make-up etc.

Miroir de maquillage

- utilisable à l'horizontale et à la verticale
- avec compartiment pratique pour les bijoux, produits cosmétiques etc.

Spiegel im Quer- und Hochformat verwendbar
Mirror can be used in portrait or landscape format
Miroir utilisable au format portrait ou paysage



 x 1
12,0 x 17,3 cm



8476 ... 886
ca. 12,0 x 17,3 cm

100
Weiß

226
Sandbeige

685
Maledivia

783
Mare

926
Schwarz

977
Platin

BLADE MIRROR

Metall chromiert + Glas / Chrome-plated metal + glass / Métal chromé + verre

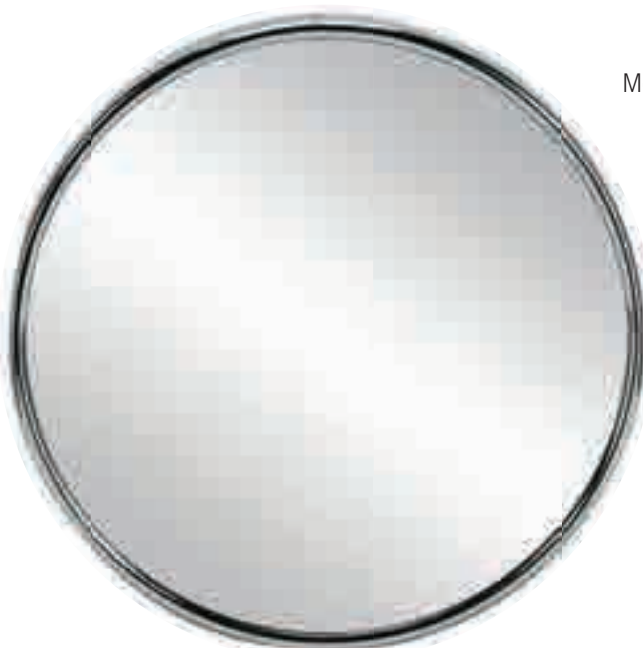

Rückseite mit Saugnäpfen zur einfachen Befestigung

Back with suction cups for easy attachment
Arrière avec ventouses pour une fixation facile



Kosmetikspiegel

- 5-fache Vergrößerung
- hochwertiger Chromrand
- hohe Saugkraft

Cosmetic mirror

- 5-fold enlargement
- high-grade chrome edge
- high suction power

Miroir de maquillage

- grossissement x5
- bordure chromée de qualité
- force de succion élevée

 x 5
Ø 15,0 cm

886 Kosmetikspiegel
ca. 15,0 x 15,0 x 3,5 cm

8423 124 886
BLADE MIRROR / 124 SILBER

BRILLIANT MIRROR

Metall chromiert + Glas / Chrome-plated metal + glass / Métal chromé + verre

LED-Kosmetikspiegel

- mit LED-Beleuchtung
- beweglicher Gelenkarm
- drehbar um 360°
- inkl. Befestigungsmaterial

LED-Cosmetic mirror

- with LED lights
- movable jointed arm
- rotatable by 360°
- mounting material is included

LED-Miroir de maquillage

- avec éclairage LED
- bras articulé mobile
- pivote à 360°
- matériel de fixation fourni



886 Kosmetikspiegel
ca. 25,0 x 27,0 x 3,5 cm

8428 124 886
BRILLIANT MIRROR / 124 SILBER

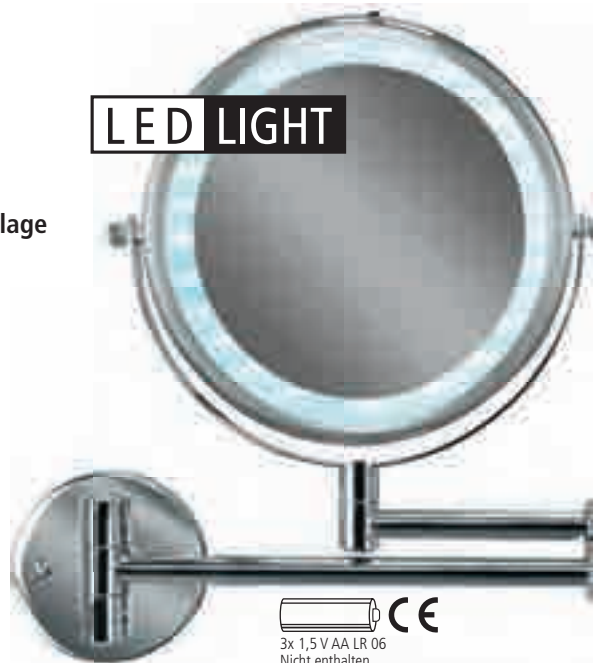
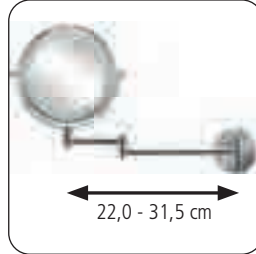
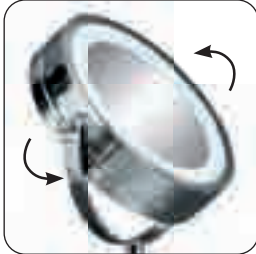

EASY MIRROR

Polystyrol + Glas / Polystyrene + glass / Polystyrène + verre

Kosmetikspiegel

- 5-fache Vergrößerung
- hohe Saugkraft

Cosmetic mirror

- 5-fold enlargement
- strong suction

Miroir de maquillage

- grossissement x5
- puissante ventouse



886 Kosmetikspiegel
ca. 15,3 x 15,3 x 2,5 cm

5098 116 886
EASY MIRROR / 116 CLEAR



Rückseite mit Saugnäpfen
zur einfachen Befestigung
Back with suction cups
for easy attachment
Arrière avec ventouses
pour une fixation facile



FLEXY COLOR

Polystyrol + Glas / Polystyrene + glass / Polystyrène + verre

Kosmetikspiegel mit Gelenk

- 5-fache Vergrößerung
- flexibel durch Kugel-Gelenk
- verstärkte Saugkraft durch Dreh-Funktion

Cosmetic mirror with joint

- 5 fold enlargement
- flexible due to ball-and-socket joint
- increased suction power due to rotation function

Miroir de maquillage avec l'articulation sphéroïdale

- grossissement x5
- flexible grâce à l'articulation sphéroïdale
- force d'adhésion renforcée de la ventouse grâce à la fonction rotative



886 Kosmetikspiegel
ca. 17,5 x 17,5 x 10,5 cm

5820 116 886
FLEXY COLOR / 116 WEISS



fixieren / fix / fixer



lösen / loosen / résoudre

POWER HOLD

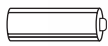
 **CE**
4x 1,5 V AAA LR 03
Nicht enthalten.
Not included / Non inclus

LED LIGHT

dimmbar / dimmable



 **x 7**
Ø 21,5 cm

FLEXY CUBE

ABS Kunststoff + Glas /
ABS plastic + glass / ABS plastique + verre

LED-Kosmetikspiegel mit Gelenk

- LED-Beleuchtung dimmbar
- 7-fache Vergrößerung
- Flexibel durch Kugel-Gelenk
- Verstärkte Saugkraft durch Dreh-Funktion

LED-Cosmetic mirror with joint

- with LED lights
- 7 fold enlargement
- flexible due to ball-and-socket joint
- increased suction power due to rotation function

LED-Miroir de maquillage avec l'articulation sphéroïdale

- avec éclairage LED
- grossissement x7
- flexible grâce à l'articulation sphéroïdale
- force d'adhésion renforcée de la ventouse grâce à la fonction rotative

886 Kosmetikspiegel
ca. 21,5 x 21,3 x 10,5 cm

8098 100 886
FLEXY CUBE / 100 WEISS

 **CE**
4x 1,5 V AAA LR 03
Nicht enthalten.
Not included / Non inclus

POWER HOLD

fixieren / fix / fixer



lösen / loosen / résoudre

 **x 7**
Ø 17,5 cm

LED LIGHT



FLEXY LIGHT

Polystyrol + Glas / Polystyrene + glass / Polystyrène + verre

LED-Kosmetikspiegel mit Gelenk

- mit LED-Beleuchtung
- 5-fache Vergrößerung
- flexibel durch Kugel-Gelenk
- verstärkte Saugkraft durch Dreh-Funktion

LED-Cosmetic mirror with joint

- with LED lights
- 5 fold enlargement
- flexible due to ball-and-socket joint
- increased suction power due to rotation function

LED-Miroir de maquillage avec l'articulation sphéroïdale

- avec éclairage LED
- grossissement x5
- flexible grâce à l'articulation sphéroïdale
- force d'adhésion renforcée de la ventouse grâce à la fonction rotative

886 Kosmetikspiegel
ca. 17,5 x 17,5 x 10,5 cm

5819 114 886
FLEXY LIGHT / 114 SCHNEEWEISS

fixieren / fix / fixer



lösen / loosen / résoudre

POWER HOLD

 **CE**
3x 1,5 V AAA LR 03
Nicht enthalten.
Not included / Non inclus

LED LIGHT

dimmbar / dimmable



 **x 10**
Ø 20,0 cm

FLEXY MAX

ABS Kunststoff + Glas /
ABS plastic + glass / ABS plastique + verre

LED-Kosmetikspiegel mit Gelenk

- LED-Beleuchtung dimmbar
- 10-fache Vergrößerung
- Flexibel durch Kugel-Gelenk
- Verstärkte Saugkraft durch Dreh-Funktion

LED-Cosmetic mirror with joint

- with LED lights
- 10 fold enlargement
- flexible due to ball-and-socket joint
- increased suction power due to rotation function

LED-Miroir de maquillage avec l'articulation sphéroïdale

- avec éclairage LED
- grossissement x10
- flexible grâce à l'articulation sphéroïdale
- force d'adhésion renforcée de la ventouse grâce à la fonction rotative

886 Kosmetikspiegel
ca. 17,5 x 17,5 x 10,5 cm

8099 127 886
FLEXY MAX / 100 WEISS-SILBER

LUMI MIRROR

Metall chromiert + Glas / Chrome-plated metal + glass / Métal chromé + verre

LED-Kosmetikspiegel

- 1-7-fache Vergrößerung
- mit 3 Lichttemperaturen
- beweglicher Gelenkarm
- drehbar um 360°
- inkl. Befestigungsmaterial
- Batteriebetrieb

LED-Cosmetic mirror

- 1/7 fold enlargement
- 3 selectable light temperatures
- movable jointed arm
- rotatable by 360°
- mounting material is included
- Battery powered

LED-Miroir de maquillage

- grossissement x1/x7
- 3 températures lumineuses au choix
- bras articulé mobile
- pivote à 360°
- matériel de fixation fourni
- Fonctionne avec des piles



LED LIGHT

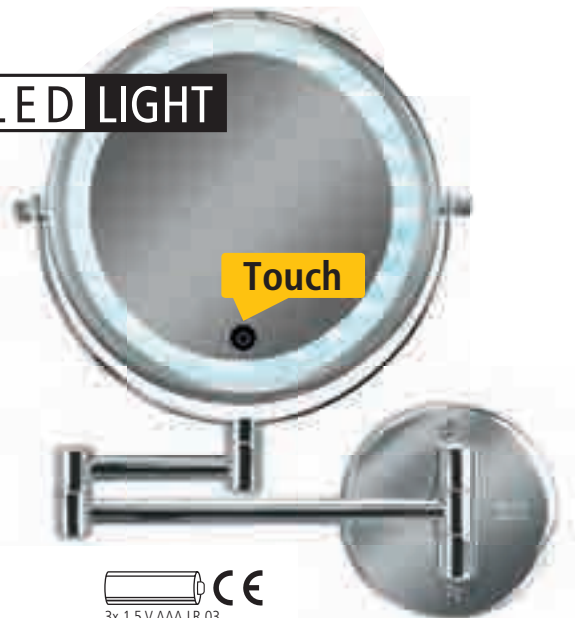

3x 1,5 V AAA LR 03
Nicht enthalten.
Not included / Non inclus

886 Kosmetikspiegel
ca. 29,0 x 36,0 x 4,0 cm

8487 124 886
LUMI MIRROR / 124 SILBER

x 1 / x 7
Ø 22,0 cm

MINI MIRROR

EVA / Glas / Glass / Verre

Klebespiegel

- einfach anzubringen
- 3-fache Vergrößerung

Adhesive mirror

- easy to install
- 3x magnification

Miroir adhésif

- fixation facile sans percer
- Grossissement x3

x 3
Ø 12,0 cm



Rückseite mit Klebepunkt
Backside with glue dot
Derrière avec point de colle

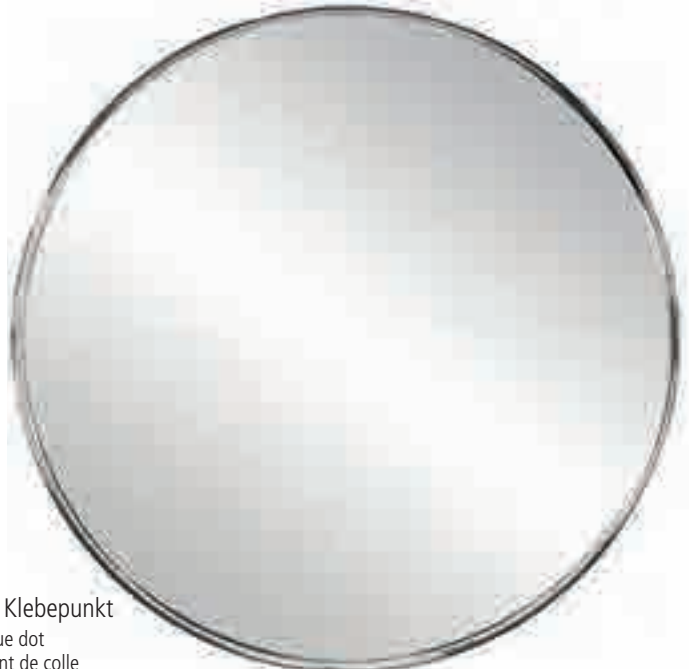

886 Kosmetikspiegel
ca. 12,0 x 12,0 x 0,5 cm

8057 124 886
MINI MIRROR / 124 SILBER

MOVE MIRROR

Metall chromiert + Glas / Chrome-plated metal + glass / Métal chromé + verre

Kosmetikspiegel

- schwenkbarer und ausziehbarer Arm
- drehbar um 360°
- inkl. Befestigungsmaterial

Cosmetic mirror

- swivel mounted and extendable arm
- rotatable by 360°
- mounting material is included

Miroir de maquillage

- bras extensible et pivotant
- pivote à 360°
- matériel de fixation fourni

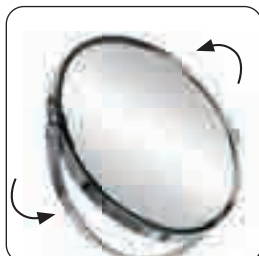

x 1 / x 5
Ø 17,0 cm



886 Kosmetikspiegel
ca. 20,0 x 37,5 x 2,0 cm

8426 124 886
MOVE MIRROR / 124 SILBER

RIDGE MIRROR

Metall chromiert + Glas / Chrome-plated metal + glass / Métal chromé + verre

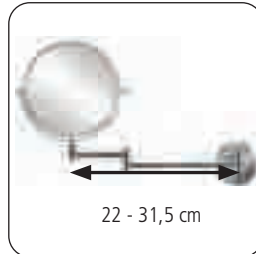
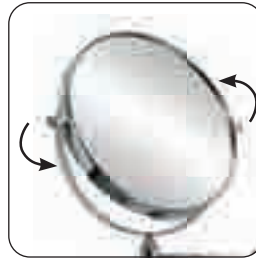

Kosmetikspiegel

- beweglicher Gelenkarm
- drehbar um 360°
- inkl. Befestigungsmaterial

Cosmetic mirror

- movable jointed arm
- rotatable by 360°
- mounting material is included

Miroir de maquillage

- bras articulé mobile
- pivote à 360°
- matériel de fixation fourni

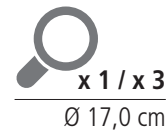

886 Kosmetikspiegel
ca. 24,6 x 26,0 x 3,5 cm

8427 124 886
RIDGE MIRROR / 124 SILBER

ROPE MIRROR

Metall + Glas + Hanf
Metal + glass + hemp
Métal chromé + verre + chanvre

Kosmetikspiegel

- Mit Hanfseil zum Aufhängen

Cosmetic mirror

- hemp rope to hang

Miroir de maquillage

- Peut être suspendu
avec une corde de chanvre

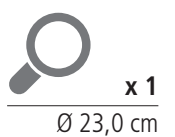

886 Kosmetikspiegel
ca. 23,0 x 39,5 x 2,0 cm

8653 926 886
ROPE MIRROR / 926 SCHWARZ

WC-Sitze

WC seats / Abattants wc



DUROPLAST

WC-Sitze aus Duroplast

- Absenkautomatik
- bequeme Montage von oben
- zur Reinigung einfach abnehmbar
- passend für alle handelsüblichen WCs
- alle Metallteile aus rostfreiem Edelstahl

WC seats made of duroplastic

- soft-close mechanism
- convenient assembly from above (likewise possible from below)
- easy to remove for cleaning
- suitable for all commercially available WCs
- all metal parts made of stainless steel

Abattants WC en duroplastique

- descente assistée pour abattant
- montage pratique par le haut (également possible par le bas)
- facilement amovible pour le nettoyage
- adapté pour tous les WC en usage dans le commerce
- toutes les pièces métalliques sont en acier affiné inoxydable

SOFT CLOSING



EASY INSTALL



EASY CLICK

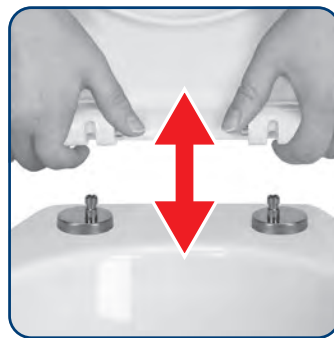

EASY CLEAN



BLOSSOM 37 x 45 cm

Duroplast



1857 401 075
Nelke

BORKUM 37 x 45 cm

Duroplast



1867 148 075
Multicolor

COSMO CAT 37 x 45 cm

Duroplast



1855 148 075
Multicolor

DAHLIA 37 x 45 cm

Duroplast



1866 851 075
Lavendel

EULEN 37 x 45 cm

Duroplast



1837 271 075
Taupe

FLORES 37 x 45 cm

Duroplast



1860 148 075
Multicolor

GARDEN 37 x 45 cm

Duroplast



1859 148 075
Multicolor

JACKSONS 37 x 45 cm

Duroplast



1865 190 075
Weiß Schwarz

MARBLE 37 x 45 cm

Duroplast



1843 901 075
Anthrazit

ROSEMARIE 37 x 45 cm

Duroplast



1853 428 075
Bordeaux

SARDINAS 37 x 45 cm

Duroplast



1868 148 075
Multicolor

SAVANNAH 37 x 45 cm

Duroplast



1863 148 075
Multicolor

SLATE 37 x 45 cm

Duroplast



1862 905 075
Schiefer

UNI 37 x 45 cm

Duroplast



1823 100 075
Weiss

ZEN 37 x 45 cm

Duroplast



1825 148 075
Multicolor

ERSATZTEILE

Replacements / Pièces de rechange

WC Montage-Set, 6-teilig

1839 101 948
Chromfarbig

Toilet fitting kit, 6 pieces

Kit de montage pour WC, 6 parties

WC Deckelpuffer, 6-teilig

1813 100 948
Weiß

Toilet seat bumper, 6 pieces

Amortisseur pour abattant de WC, 6 parties

Dusch- vorhänge

Shower curtains / Rideaux de douche

TEXTIL-DUSCHVORHÄNGE 100% Polyester 207-224

Textile shower curtains / Rideaux de douche en textile

Produkteigenschaften

- aus hochwertigem Polyestergewebe
- besonders haltbares und pflegeleichtes Material
- wasserabweisend
- verstärkte Lochleiste mit stabilen Ösen
- Beschwerungsband im unteren Saum

Product features

- high-quality textile fabric
- highly durable and easy-to-clean material
- water repellent
- reinforced perforated strip with sturdy eyelets
- weighted curtain ribbon in bottom belt

Caractéristiques du produit

- Textil de qualité supérieure
- particulièrement résistants et faciles à entretenir
- résistant à l'eau
- rebord renforcé à trous avec oeillets robustes
- cordon de lestage dans l'ourlet du bas

PEVA-DUSCHVORHÄNGE Ökoplast / PVC-frei 224-232

PEVA shower curtains Ecoplast / PVC-free / Rideaux de douche en PEVA Ecoplast / sans PVC

Produkteigenschaften

- PEVA / Öko-Plast aus PVC-freiem, umweltfreundlichem und recyclefähigem Material (Polyethylenvinylacetat)
- absolut wasserdicht
- verstärkte Lochleiste

Product features

- PVC-free material, recyclable and environmentally friendly
- completely waterproof
- reinforced perforated strip

Caractéristiques du produit

- matériau sans PVC, écologique et recyclable
- complètement étanche
- bande perforée enforcée

VINYL-DUSCHVORHÄNGE 100% Vinyl 233

Vinyl shower curtains 100% vinyl / Rideaux de douche en vinyle 100% vinyle

Produkteigenschaften

- aus kräftiger Vinyl-Folie
- besonders haltbares Material
- absolut wasserdicht

Product features

- strong vinyl film
- very durable material
- completely waterproof

Caractéristiques du produit

- film vinyle résistant
- matière très résistante
- complètement étanche

„Viele unserer textilen Duschvorhänge und Vorhänge aus PEVA sind Oeko-Text 100 zertifiziert.“



Textile shower curtains / Rideaux de douche en textile



ALHAMBRA 207



ANCHOR 207



BARCELONA 207



BATH 208



BATHROOM 208



BIRDIE 208



BLOSSOM 209



BORKUM 209



BOW 209



BUTTERFLIES 210



CANTON 210



CHECK 210

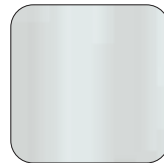

CARAVELLE 211



CARAVELLE 211



CLASSY 212



CONCHA 212



COTTI 212



DAHLIA 213



EULEN 213



FLORES 213



FLORESTA 214



GARDEN 214



GEORGE 214



JACKSONS 215



HOOK ON 215



JOLIE 216

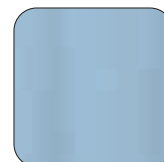

KITO 216



LEAF 217



LUNA 217



MAGIC 217



MARBLE 218



MIAMI 218



NOVA 218

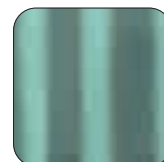

RICCA 219



RINGS 219



ROSALIE 220



ROSEMARIE 220



SANNA 220



SARDINAS 221



SAVANNAH 221



SELVA 221



SCRIPT 222



SEASIDE 222



SELECT 222

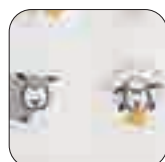

SHEEP 223



SYLT 223



TEMPTATION 223



YOGI 224



ZAG COTTI 224

PEVA DUSCHVORHÄNGE SEITE 224-232

PEVA shower curtains Ecoplast / PVC-free / Rideaux de douche en PEVA Ecoplast / sans PVC



BAMBÚ 224



BLOOM 225



BROOKLYN 225

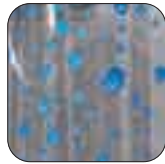

BUBBLE 225



CLARO 226



CLIPPER 226



CONFETTI 226



CRISTALLO 227



DOLPHIN 227



FROSTY 227



MALEDIVEN 228



NEW BEACH 228



NOA 228



PHILO 229



POCKET 229



REISELUST 230

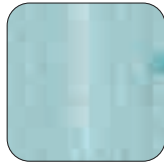

SOAPY 230



SONNY 231

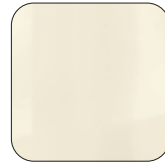

UNO 231



VIVA 231



WONDERLAND 232



ZACK 232

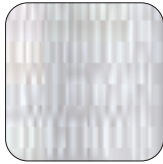

ZORA 232

VINYL DUSCHVORHÄNGE SEITE 233

Vinyl shower curtains 100% vinyl / Rideaux de douche en vinyle 100% vinyle



GRAFICO 233

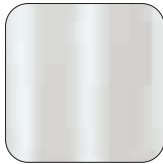

PHÖNIX 233



SKY 233

ALHAMBRA

TEXTIL 100% Polyester



685
Maledivia



7817 ... 305
ca. 180 x 200 cm

ANCHOR

TEXTIL 100% Polyester



789
Dunkelblau



5900 ... 305
ca. 180 x 200 cm



5900 ... 238
ca. 120 x 200 cm

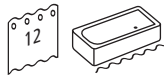

5900 ... 344
ca. 180 x 180 cm

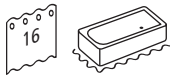

5900 ... 352
ca. 240 x 180 cm

BARCELONA

TEXTIL 100% Polyester



602
Klee



5188 ... 305
ca. 180 x 200 cm



5188 ... 238
ca. 120 x 200 cm

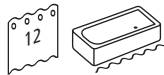

5188 ... 344
ca. 180 x 180 cm

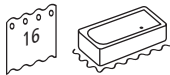

5188 ... 352
ca. 240 x 180 cm

BATH

TEXTIL 100% Polyester



185
Schwarz-Weiß



5959 ... 305
ca. 180 x 200 cm



BATHROOM

TEXTIL 100% Polyester



654
Mint

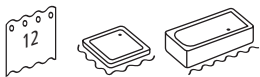

5219 ... 305
ca. 180 x 200 cm



BIRDIE

TEXTIL 100% Polyester



100
Weiß



4985 ... 305
ca. 180 x 200 cm





**FOTOREALISTISCHER
DRUCK**

Photorealistic print
Qualité satinée brillante

BLOSSOM

TEXTIL 100% Polyester

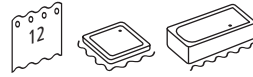

5956 ... 305
ca. 180 x 200 cm

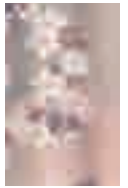

401
Nelke



5956 ... 238
ca. 120 x 200 cm

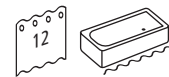

5956 ... 344
ca. 180 x 180 cm

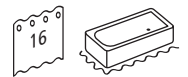

5956 ... 352
ca. 240 x 180 cm



**FOTOREALISTISCHER
DRUCK**

Photorealistic print
Qualité satinée brillante

BORKUM

TEXTIL 100% Polyester



7830 ... 305
ca. 180 x 200 cm

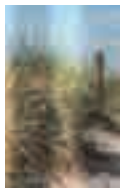

148
Multicolor



BOW

TEXTIL 100% Polyester



7821 ... 305
ca. 180 x 200 cm



301
Nussbraun

BUTTERFLIES

TEXTIL 100% Polyester



148
Multicolor

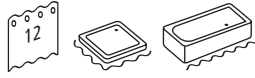

5282 ... 305
ca. 180 x 200 cm



5282 ... 238
ca. 120 x 200 cm

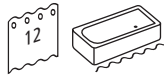

5282 ... 344
ca. 180 x 180 cm



5282 ... 352
ca. 240 x 180 cm



CANTON

TEXTIL 100% Polyester



114
Schneeweiß



4994 ... 305
ca. 180 x 200 cm



CHECK

TEXTIL 100% Polyester



271
Taupe



783
Mare



5270 ... 305
ca. 180 x 200 cm

Nur für 783 Mare: Only for 783 Mare: / Only for 783 Mare:



5270 783 238
ca. 120 x 200 cm



5270 783 344
ca. 180 x 180 cm



5270 783 352
ca. 240 x 180 cm





TEXTIL 100% Polyester



100
Weiß

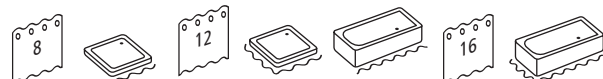

0308 ... 238
ca. 120 x 200 cm

0308 ... 305
ca. 180 x 200 cm

0308 ... 352
ca. 240 x 180 cm

Der Duschvorhang in Wunschgröße **CARAVELLE**

The shower curtain in custom sizes / Le rideau de douche de la taille de votre choix

TEXTIL 100% Polyester

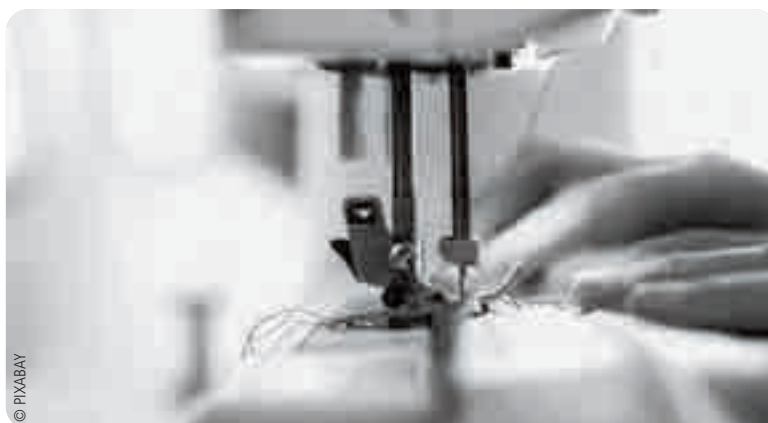

Sonderanfertigung
Special model / Modèle spécial
Custom dimensions
Dimensions souhaitées

© PIXABAY

Wunschmaß
custom size /
Dimensions souhaitées
0308 ... 833
pro 1,0 m lft.
Meterware
Meter / Mètre
0308 ... 824
ca. 2,0 m breit lfm.,
unbearbeitet

ZU BEACHTEN BEI BESTELLUNGEN VON WUNSCHMASS + METERWARE:

Note when ordering custom sizes + yard goods: / Lors des commandes prendre en compte dimensions souhaitées + marchandises au mètre:

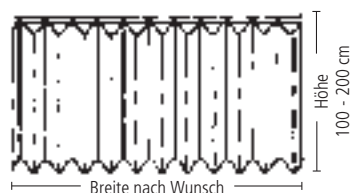

Breite nach Wunsch

- Breite mind. 60 cm
- Höhe von mind. 100 cm bis max. 200 cm
- inkl. Gardinenfaltband (Konfektionsart A) bzw. Ösenkante (Konfektionsart B)*

Any width

- minimum width 60 cm
- height min. 100 cm to max. 200 cm
- includes pleat tape (top style A) or grommets (top style B)*

Largeur sur demande

- Largeur de 60 cm min.
- Hauteur de 100 cm min. à 200 cm max.
- avec bande plissée de rideau (type de confection A) ou œillets (type de confection B)*

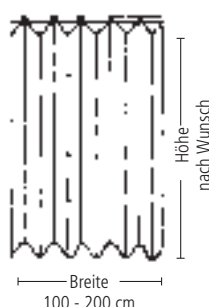

Höhe nach Wunsch

- Höhe mind. 100 cm, max. 350 cm
- Breite von mind. 60 cm bis max. 200 cm
- inkl. Gardinenfaltband (Konfektionsart A) bzw. Ösenkante (Konfektionsart B)*

Any height

- height min. 100 cm, max. 350 cm
- width min. 60 cm to max. 200 cm
- includes pleat tape (top style A) or grommets (top style B)*

Hauteur sur demande

- Hauteur de 100 cm min., de 350 cm max.
- Largeur de 60 cm min. à 200 cm max.
- avec bande plissée de rideau (type de confection A) ou œillets (type de confection B)*

Bitte beachten Sie, dass der Duschvorhang-Stoff auf 2,0 Meter Breite liegt. Das bedeutet, dass entweder die Höhe oder die Breite dieses Maß nicht überschreiten darf!

Please note, the shower curtain fabric has a width of 2,0 meters. That means either the width or the height must not exceed this size!

Veillez noter que le tissu du rideau de douche a une largeur de 2,0 mètres. Cela signifie que la largeur ou la hauteur ne doit pas dépasser cette taille!

Konfektionsarten zur Wahl*:

A) Gardinenfaltband für Gardinenschiene oder

B) Klarsichtige, hochfeste Kunststoffösen für Duschvorhangstange.

Auftragsvermerk: Maße, Konfektionsart und Konfektionsstelle (Schmal- oder Breitseite)

Lieferzeit: ca. 6 Wochen. Rücktrittsrecht ausgeschlossen.

Top style options*:

A) Pleat tape for curtain track or

B) Clear, high-strength plastic eyelets for curtain rod.

Order comments: Dimensions, top style and top location (short or long side)

Lead time: approx. 6 weeks. No cancellations.

Types de confection au choix*:

A) Bande plissée adaptée aux tiges des rideaux ou

B) Œillets en plastique transparents et très résistants pour la tige du rideau.

Note relative à la commande: dimensions, type de confection et lieu de confection (côté étroit ou côté large).

Temps de livraison: env. 6 semaines. Pas de droit de résiliation.

CLASSY

TEXTIL 100% Polyester



PREMIUM TEXTIL

GLÄNZENDE SATIN-QUALITÄT

Glossy satin quality
Qualité satinée brillante



100
Weiß



5911 ... 305
ca. 180 x 200 cm



5911 ... 238
ca. 120 x 200 cm



5911 ... 344
ca. 180 x 180 cm

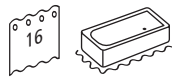

5911 ... 352
ca. 240 x 180 cm



CONCHA

TEXTIL 100% Polyester



754
Iceblue



7832 ... 305
ca. 180 x 200 cm



COTTI

TEXTIL 65% Polyester + 35% Baumwolle



901
Anthrazit



7809 ... 305
ca. 180 x 200 cm

PREMIUM TEXTIL

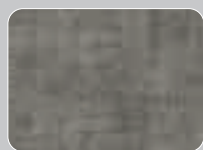

Hochwertiger Duschvorhang
aus textilem Mischgewebe
von Polyester und Baumwolle

High quality shower curtain made of
textile blend of polyester and cotton
Rideau de douche de haute qualité en
mélange textile de polyester et de coton



NEW



DAHLIA

TEXTIL 100% Polyester



Das passt dazu:

DAHLIA
Badteppich im passenden Design
> Seite 33



851
Lavendel



7828 ... 305
ca. 180 x 200 cm



EULEN

TEXTIL 100% Polyester



5222 ... 305
ca. 180 x 200 cm



271
Taupe



5222 ... 238
ca. 120 x 200 cm



5222 ... 344
ca. 180 x 180 cm



5222 ... 352
ca. 240 x 180 cm



FLORES

TEXTIL 100% Polyester



Das passt dazu:

That fits: / Ça correspond:

GARDEN
Sicherheitseinlagen im passenden Design
Safety inserts with fitting image

Tapis anti-dérapants avec image appropriée

> Seite 253 / page 253



148
Multicolor



7806 ... 305
ca. 180 x 200 cm

FLORESTA

TEXTIL 100% Polyester



600
Grün



5912 ... 305
ca. 180 x 200 cm



5912 ... 238
ca. 120 x 200 cm

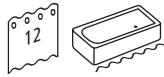

5912 ... 344
ca. 180 x 180 cm



5912 ... 352
ca. 240 x 180 cm



GARDEN

TEXTIL 100% Polyester



148
Multicolor



7805 ... 305
ca. 180 x 200 cm



GEORGE

TEXTIL 100% Polyester



271
Taupe



5958 ... 305
ca. 180 x 200 cm

FOTOREALISTISCHER
DRUCK

Photorealistic print
Qualité satinée brillante





**FOTOREALISTISCHER
DRUCK**

Photorealistic print
Qualité satinée brillante

Das passt dazu:
That fits: / Ça correspond:

JACKSONS
WC-Sitz mit passendem Motiv

WC lid with fitting image
Couvercle de WC avec image appropriée
> Seite 220 / page 220

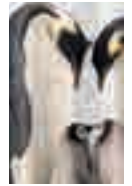

190
Weiß Schwarz

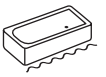

7822... 305
ca. 180 x 200 cm

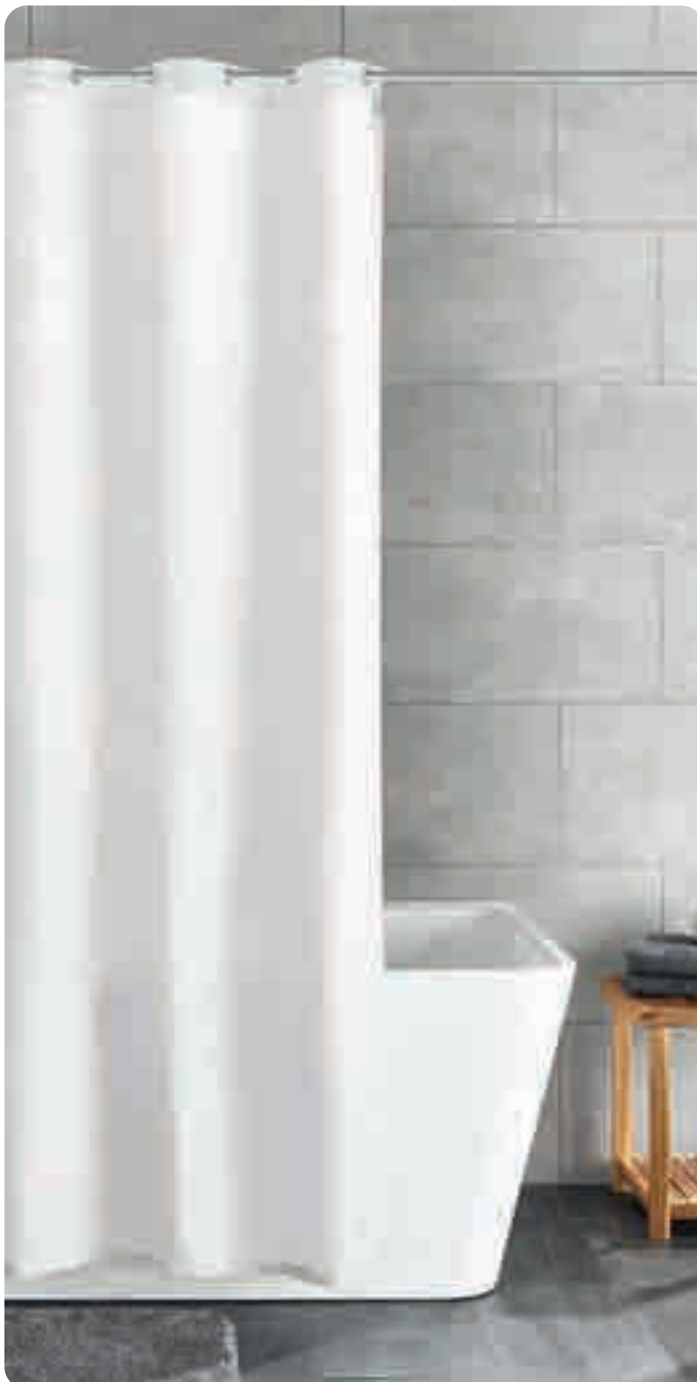

**PREMIUM
TEXTIL**

GLÄNZENDE SATIN QUALITÄT

Glossy satin quality
Qualité satinée brillante

HOOK ON

TEXTIL 100% Polyester



**Premium-Duschvorhang
mit integrierten Ringen**



Premium shower curtain with integrated rings
Rideau de douche de qualité supérieure avec
anneaux intégrés

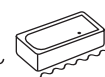

5913 ... 305
ca. 180 x 200 cm



100
Weiß

JOLIE

TEXTIL 100% Polyester



148
Multicolor

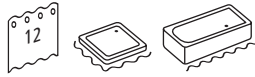

5194 ... 305
ca. 180 x 200 cm



5194 ... 238
ca. 120 x 200 cm

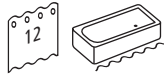

5194 ... 344
ca. 180 x 180 cm

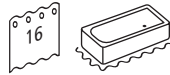

5194 ... 352
ca. 240 x 180 cm



KITO

TEXTIL 100% Polyester



114
Schneeweiß



202
Natur



723
Azur



905
Schiefer



913
Nebel



4937 ... 305
ca. 180 x 200 cm



4937 ... 238
ca. 120 x 200 cm



4937 ... 352
ca. 240 x 180 cm





LEAF

TEXTIL 100% Polyester



Das passt dazu:

That fits: / Ça correspond:

LEAF

Accessoires-Serie mit Blättermotiv

Accessories series with leaf motif

Série d'accessoires avec motif de feuilles

> Seite 163 / page 163



685
Maledivia

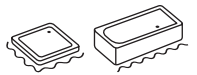

5961 ... 305
ca. 180 x 200 cm



LUNA

TEXTIL 100% Polyester



185
Schwarz Weiß

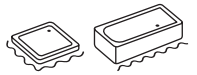

5124 ... 305
ca. 180 x 200 cm



MAGIC

TEXTIL 100% Polyester



148
Multicolor



5963 ... 305
ca. 180 x 200 cm

MARBLE

TEXTIL 100% Polyester



901
Anthrazit



5283 ... 305
ca. 180 x 200 cm



5283 ... 238
ca. 120 x 200 cm



5283 ... 344
ca. 180 x 180 cm

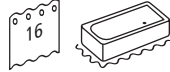

5283 ... 352
ca. 240 x 180 cm



MIAMI

TEXTIL 100% Polyester



216
Beige



700
Blau



5163 ... 238
ca. 120 x 200 cm



5163 ... 305
ca. 180 x 200 cm



NOVA

TEXTIL 100% Polyester



407
Old Rose



977
Platin



5274 ... 305
ca. 180 x 200 cm

Nur für 977 Platin: Only for 977 Platin: / Only for 977 Platin:



5274 977 238
ca. 120 x 200 cm

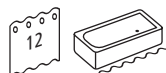

5274 977 344
ca. 180 x 180 cm



5274 977 352
ca. 240 x 180 cm





RICA

TEXTIL 100% Polyester



Der Duschvorhang RICA ist ein umweltfreundliches Naturprodukt:

- aus recyceltem Material
- mit rostfreien Metallösen

The RICA shower curtain is an environmentally friendly natural product:

- from recycled material
- with stainless metal eyelets

Le rideau de douche RICA est un produit naturel respectueux de l'environnement :

- fabriqués à partir de matériaux recyclés
- avec oeillets en métal inoxydable

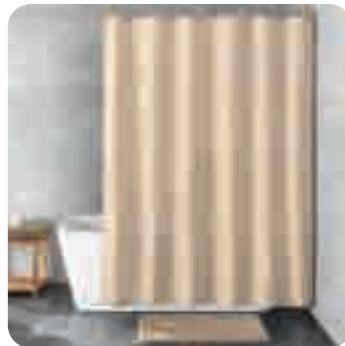

114
Schneeweiß



202
Natur

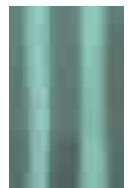

685
Maledivia



783
Mare



913
Nebel



5965 ... 305
ca. 180 x 200 cm



RINGS

TEXTIL 100% Polyester



185
Schwarz Weiß



5281 ... 305
ca. 180 x 200 cm

ROSALIE

TEXTIL 100% Polyester



FOTOREALISTISCHER
DRUCK

Photorealistic print
Qualité satinée brillante



148
Multicolor

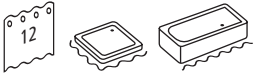

5910 ... 305
ca. 180 x 200 cm

ROSEMARIE

TEXTIL 100% Polyester



FOTOREALISTISCHER
DRUCK

Photorealistic print
Qualité satinée brillante



428
Bordeaux



5940 ... 305
ca. 180 x 200 cm

SANNA

TEXTIL 100% Polyester



100
Weiß



4935 ... 305
ca. 180 x 200 cm



4935 ... 238
ca. 120 x 200 cm

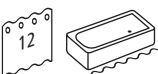

4935 ... 344
ca. 180 x 180 cm



4935 ... 352
ca. 240 x 180 cm

SARDINAS

TEXTIL 100% Polyester



Das passt dazu:

That fits: / Ça correspond:

SARDINAS

> Seite 162 / page 162

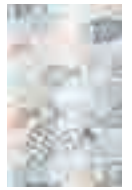

148
Multicolor

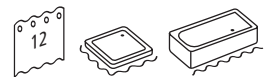

7831 ... 305
ca. 180 x 200 cm

SAVANNAH

TEXTIL 100% Polyester



Das passt dazu:

That fits: / Ça correspond:

SAVANNAH – Sicherheitseinlagen

im passenden Design

Safety inserts with fitting image

Tapis anti-dérapants avec image appropriée

> Seite 255 / page 255



148
Multicolor

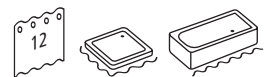

7819 ... 305
ca. 180 x 200 cm

NEW



SELVA

TEXTIL 100% Polyester



Das passt dazu:

That fits: / Ça correspond:

SELVA – Badteppich

im passenden Design

Safety inserts with fitting image

Tapis anti-dérapants avec image appropriée

> Seite 73 / page 73



616
Dill



7833 ... 305
ca. 180 x 200 cm

SCRIPT

TEXTIL 100% Polyester



148
Multicolor



5171 ... 305
ca. 180 x 200 cm



SEASIDE

TEXTIL 100% Polyester



733
Krokusblau



0856 ... 305
ca. 180 x 200 cm



0856 ... 238
ca. 120 x 200 cm

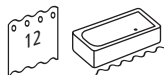

0856 ... 344
ca. 180 x 180 cm

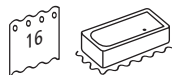

0856 ... 352
ca. 240 x 180 cm



SELECT

TEXTIL 100% Polyester

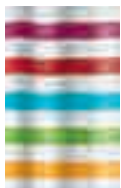

148
Multicolor



5255 ... 305
ca. 180 x 200 cm





SHEEP

TEXTIL 100% Polyester



148
Multicolor



5130 ... 305
ca. 180 x 200 cm



SYLT

TEXTIL 100% Polyester

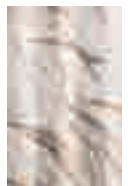

202
Natur

Das passt dazu:

That fits: / Ça correspond:

BEDFORD

Moderner Korb mit Applikationen

Modern basket with appliques
Panier moderne avec appliques

> Seite 172 / page 172

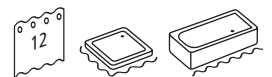

7818 ... 305
ca. 180 x 200 cm



TEMPTATION

TEXTIL 100% Polyester



851
Lavendel



7829 ... 305
ca. 180 x 200 cm

YOGI

TEXTIL 100% Polyester



148
Multicolor



5923 ... 305
ca. 180 x 200 cm



ZAG COTTI

TEXTIL 65% Polyester + 35% Baumwolle

65% Polyester + 35% Cotton / Coton



271
Taupe



7810 ... 305
ca. 180 x 200 cm

**PREMIUM
TEXTIL**

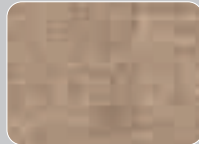

Hochwertiger Duschvorhang
aus textilem Mischgewebe
von Polyester und Baumwolle

High quality shower curtain made of
textile blend of polyester and cotton
Rideau de douche de haute qualité en
mélange textile de polyester et de coton



BAMBÚ

ÖKOPLAST 100% PEVA

PVC-frei PVC-free / sans PVC



625
Maigrün



5249 ... 305
ca. 180 x 200 cm





BLOOM

ÖKOPLAST 100% PEVA

PVC-frei PVC-free / sans PVC



398
Pearl

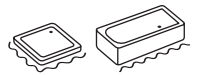

5945 ... 305
ca. 180 x 200 cm



BROOKLYN

ÖKOPLAST 100% PEVA

PVC-frei PVC-free / sans PVC



116
Clear



7823... 305
ca. 180 x 200 cm



BUBBLE

ÖKOPLAST 100% PEVA

PVC-frei PVC-free / sans PVC



769
Marineblau



5192 ... 305
ca. 180 x 200 cm

CLARO

ÖKOPLAST 100% PEVA

PVC-frei PVC-free / sans PVC



116
Clear



5920 ... 305
ca. 180 x 200 cm



CLIPPER

ÖKOPLAST 100% PEVA

PVC-frei PVC-free / sans PVC



723
Azur



901
Anthrazit

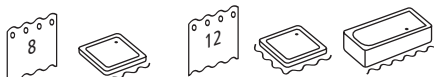

5209 ... 238
ca. 120 x 200 cm

5209 ... 305
ca. 180 x 200 cm



CONFETTI

ÖKOPLAST 100% PEVA

PVC-frei PVC-free / sans PVC



148
Multicolor



5937 ... 305
ca. 180 x 200 cm



CRISTALLO

ÖKOPLAST 100% PEVA

PVC-frei PVC-free / sans PVC



116
Clear

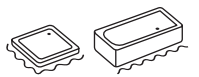

7800 ... 305
ca. 180 x 200 cm

DOLPHIN

ÖKOPLAST 100% PEVA

PVC-frei PVC-free / sans PVC



148
Multicolor



5201 ... 305
ca. 180 x 200 cm

FROSTY

ÖKOPLAST 100% PEVA

PVC-frei PVC-free / sans PVC



108
Milky



7801 ... 305
ca. 180 x 200 cm

MALEDIVEN

ÖKOPLAST 100% PEVA

PVC-frei PVC-free / sans PVC



148
Multicolor

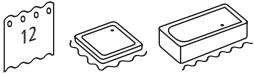

5202 ... 305
ca. 180 x 200 cm



NEW BEACH

ÖKOPLAST 100% PEVA

PVC-frei PVC-free / sans PVC



148
Multicolor



4959 ... 305
ca. 180 x 200 cm



NOA

ÖKOPLAST 100% PEVA

PVC-frei PVC-free / sans PVC



100
Weiß



5193 ... 305
ca. 180 x 200 cm





PHILO

ÖKOPLAST 100% PEVA

PVC-frei PVC-free / sans PVC



600
Grün



7802 ... 305
ca. 180 x 200 cm



POCKET

ÖKOPLAST 100% PEVA

PVC-frei PVC-free / sans PVC



Transparenter Duschvorhang
inklusive 4 Taschen mit Touchfunktion.
Geeignet für Smartphone oder Tablet.

Transparent shower curtain with 4 pockets
with touch function. Suitable for smartphone
or tablet.

Rideau de douche transparent avec 4 poches
à fonction tactile. Convient pour smartphone
ou tablette.



116
Clear



5936 ... 305
ca. 180 x 200 cm

REISELUST

ÖKOPLAST 100% PEVA

PVC-frei PVC-free / sans PVC



Inklusive wasserfesten Aufklebern
zum Markieren der persönlichen
Lieblingsorte

Including waterproof stickers for marking
your personal favourite places

Y compris des autocollants imperméables
pour marquage de vos lieux préférés



926

Schwarz



5960 ... 305

ca. 180 x 200 cm



SOAPY

ÖKOPLAST 100% PEVA

PVC-frei PVC-free / sans PVC



742

Wasserblau



5921 ... 305

ca. 180 x 200 cm





SONNY

ÖKOPLAST 100% PEVA

PVC-frei PVC-free / sans PVC



580 Sun



605 Alge



721 Blue



808 Violett



901 Anthrazit

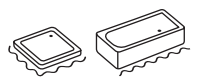

4956 ... 305
ca. 180 x 200 cm



UNO

ÖKOPLAST 100% PEVA

PVC-frei PVC-free / sans PVC



208
Ecu

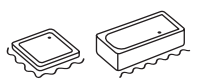

5210 ... 305
ca. 180 x 200 cm



VIVA

ÖKOPLAST 100% PEVA

PVC-frei PVC-free / sans PVC



114
Schneeweiß

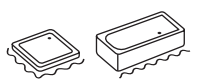

4997 ... 305
ca. 180 x 200 cm

WONDERLAND

ÖKOPLAST 100% PEVA

PVC-frei PVC-free / sans PVC



185
Schwarz Weiß



7803 ... 305
ca. 180 x 200 cm



ZACK

ÖKOPLAST 100% PEVA

PVC-frei PVC-free / sans PVC



905
Schiefer

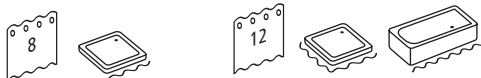

5954 ... 238
ca. 120 x 200 cm

5954 ... 305
ca. 180 x 200 cm



ZORA

ÖKOPLAST 100% PEVA

PVC-frei PVC-free / sans PVC



100
Weiß



5918 ... 305
ca. 180 x 200 cm





GRAFICO

100% VINYL



901
Anthrazit



4939 ... 305
ca. 180 x 200 cm



PHÖNIX

100% VINYL



100
Weiß



4945 ... 238
ca. 120 x 200 cm

4945 ... 305
ca. 180 x 200 cm

4945 ... 352
ca. 240 x 180 cm



SKY

100% VINYL



739
Polarblau



0826 ... 305
ca. 180 x 200 cm

Zubehör + Duschrollos

Fittings + shower blinds
Garniture + stores de douche

Das praktische Duschvorhang-Zubehör von Kleine Wolke ist einfach zu montieren, besonders langlebig, hygienisch, pflegeleicht und universell einsetzbar.

Durch die einfache Montage lassen sich auch die individuellsten Gestaltungsideen schnell und unkompliziert verwirklichen.

The practical shower curtain accessories in the Consumer Collection are attractively designed, hygienic, easy-care and universally implementable. The simple installation helps to realise the most individual design ideas, quickly and straight-forwardly.

Les accessoires pour rideau de douche pratiques de la Collection Consumer sont attrayants, hygiéniques, faciles à entretenir et universels. Leur montage simple permet de mettre en oeuvre rapidement ses propres idées de décoration.



Deckenhalterung empfohlen
 Ceiling mount kit recommended.
 Kit de montage plafond recommandé.



UNIVERSALSTANGE

Ø 25 MM

für Dusche und Badewanne
Universal rod Ø 25 mm
 for shower and bath

Barre universelle Ø 25 mm
 pour douche et baignoire

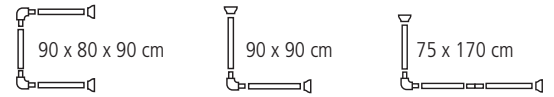

Verkürzung durch
 Absägen möglich
 Shortening possible
 by sawing off
 Raccourcissement possible
 par coupe à la scie

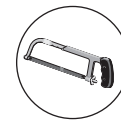

0345 ... 001

Deckenhalterung empfohlen
 Ceiling mount kit recommended.
 Kit de montage plafond recommandé.



WINKELSTANGE

Ø 25 MM

für Duschen

Angular shower curtain rod
 Ø 25 mm

Barre coudée pour rideau de
douche Ø 25 mm

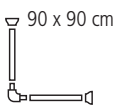

Verkürzung durch
 Absägen möglich
 Shortening possible
 by sawing off
 Raccourcissement possible
 par coupe à la scie



0348 ... 001

DECKENHALTERUNG

Ø 25 MM

für DV-Stangen mit Ø 25 mm

Suspension rod for fixing
to ceiling, Ø 25 mm
 for shower curtain rods with Ø 25 mm

Suspension à barre au
plafond, Ø 25 mm
 pour tringles à rideaux de douche avec Ø 25 mm



Verkürzung durch
 Absägen möglich
 Shortening possible
 by sawing off
 Raccourcissement possible
 par coupe à la scie



3303 ... 000

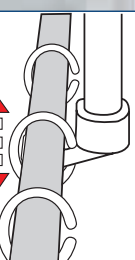
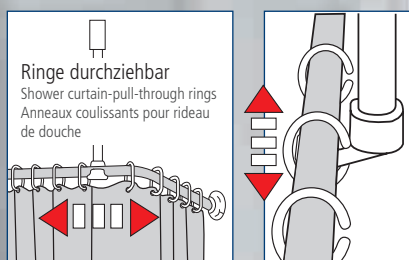

FEDERSTANGE Ø 21 mm SPRING ROD / BARRE EXTENSIBLE

Auf **gewünschte Breite + 3 cm** ausziehen und einspannen

Simply pullout to **desired length + 3 cm** and clamp into position.

Tirer à la **largeur adéquate + 3 cm**, puis comprimer et relâcher à l'endroit choisi.



Verkürzung durch Absägen auf eine Länge von 20cm möglich.

Shortening possible by sawing off to a length of 20 cm. Raccourcissement possible par coupe à la scie à une longueur de 20 cm.

0361 ... 000

0362 ... 000

75 - 125 cm

125 - 220 cm



100 Weiß



101 Chromfarbig



926 Schwarz



Hinweis zur Montage

Alle Federstangen müssen vor dem Einspannen immer auf die **gewünschte Breite + 3 cm** ausgezogen werden, damit die Stange auf Spannung gebracht wird.

Installation advice: Before being clamped, all spring rods must always be pulled out to the **desired width + 3 cm** so that the rod is tensioned.

Remarque de montage : Avant de fixer l'article, toujours déplier toutes les barres à ressorts à la **largeur souhaitée + 3 cm**, pour que la barre se trouve sous tension.

FEDERSTANGE mit Struktur, Ø 21 mm

Spring rod with structure

Barre extensible avec structure



Verkürzung durch Absägen möglich auf eine Länge von 20cm.

Shortening possible by sawing off to a length of 20 cm. Raccourcissement possible par coupe à la scie à une longueur de 20 cm.

3343 ... 014

3343 ... 034

75 - 125 cm

125 - 220 cm



101 Chromfarbig

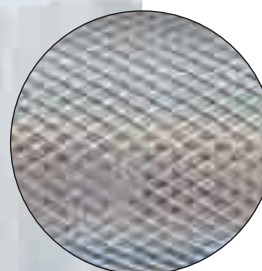

Mit geriffelter Oberflächen-Struktur

With ribbed surface structure
Avec nervures structure de la surface

Federstange zu weit ausgezogen? Kein Problem! Mit dieser Anleitung wird die Stange schnell wieder einsatzbereit:

Spring rod extended too far? No problem! These instructions will help you get the rod quickly ready for use again:

Vous avez trop étiré la barre à ressorts ? Pas de problème ! Ces instructions vous permettront rapidement de remettre votre barre en état de marche :

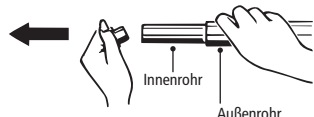

1. Stange komplett auseinanderbauen. Dazu die **Endstücke abnehmen** und das weiße **Übergangsstück abziehen**. Die Stange besteht aus einem Innenrohr (kleinerer Durchmesser mit Feder) und dem Außenrohr.

1. Disassemble the rod completely. To do this, **remove the end pieces** and the **white adapter piece**. The rod consists of an inner tube (smaller diameter with spring) and the outer tube.

1. Démontez totalement la barre. À cet effet, **retirer les embouts et enlever la pièce intermédiaire blanche**. La barre se compose d'un tube intérieur (avec le plus petit diamètre et un ressort) et d'un tube extérieur.



2. Das Innenrohr komplett **aus dem Außenrohr ziehen**.

2. Completely **remove the inner tube from the outer tube**.

2. Retirer complètement le tube intérieur **du tube extérieur**.



3. Das Innenrohr mit der Seite **ohne Feder** wieder in das Außenrohr stecken und bis zur anderen Seite **durchschieben/-ziehen**. Dann kann das Übergangsstück aufgeschoben und die Endstücke wieder eingesetzt werden.

3. Put the inner tube with the side **without the spring** back into the outer tube and push/pull it through to the other side. The adapter piece can then be pushed on and the end pieces reattached.

3. Emboîter de nouveau le tube intérieur avec le côté **dénué de ressort** dans le tube extérieur, et **le pousser/le faire passer au travers** jusqu'à l'autre côté. La pièce intérieure peut alors être décalée, et les embouts peuvent être remis en place.



4. Die Stange ist nun wieder funktionsfähig und lässt sich auf die gewünschte Länge ausziehen.

4. The rod is now ready for use again and can be extended to the desired length.

4. Désormais, la barre est de nouveau fonctionnelle, et peut se rallonger à la longueur souhaitée.



FEDERSTANGE Ø 25 mm

Auf **gewünschte Breite + 3 cm**
ausziehen und einspannen

Simply pullout to **desired length + 3 cm**
and clamp into position.

Tirer à la **largeur adéquate + 3 cm**,
puis comprimer et relâcher à l'endroit choisi.



Verkürzung durch
Absägen möglich auf
eine Länge von 20cm.

Shortening possible by sawing off to a length of 20 cm.
Raccourcissement possible par coupe à la scie à une
longueur de 20 cm.



100 Weiß



101 Chromfarbig

0347 ... 001

75 - 125 cm

0346 ... 001

125 - 220 cm

3302 ... 000

145 - 250 cm



ERGÄNZUNGSTEILE

Ø 25 mm

für DV-Stangen Ø 25 mm /
for shower curtain rod Ø 25 mm /
pour barre à rideau de douche Ø 25 mm

ENDSTÜCK

End fitting / Extrémité

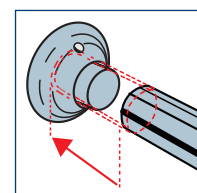

100 Weiß

Länge 6 cm
length 6 cm
longueur 6 cm

3307 ... 000
2 Stück



SCHRÄGWAND- HALTER

Zur Befestigung von
Duschgestängen
an schrägen Wänden

Mounting bracket for
sloping ceiling

Holding fit for shower curtain rods
on oblique walls.

Support mural transversal

Support pour l'installation de barres
sur murs obliques.



100 Weiß

0395 ... 000
1 Stück

RUNDSTANGE Ø 25 mm

für Duschwannen

Round pole for shower
Tige arrondie pour douche



101 Chromfarbig



90 x 90 cm
oder Zwischenmaße
80-90 x 80-90 cm

3301 ... 000



Verkürzung durch
Absägen möglich
Shortening possible
by sawing off
Raccourcissement possible
par coupe à la scie



DUSCHSTANGE BOGEN

Ø 25 mm

Duschstange mit Teleskop-System

Telescopic shower curtain rod
Barre de Douche avec système télescopique

101 Chromfarbig

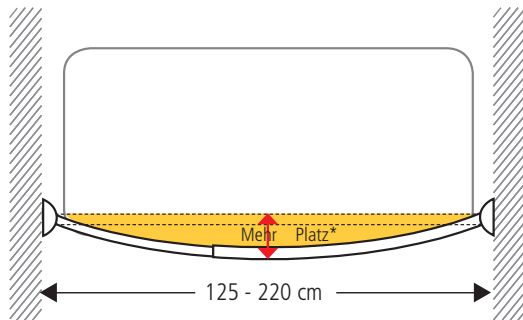
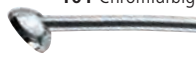

3334 ... 000
125 - 220 cm



SEILSYSTEM ca. 500 cm



Seilsystem mit Gelenk

Cable system with joint
Ensemble de cordes avec articulation

3308 ... 000



101 Chromfarbig

S-HAKEN 12 Stück / pieces



S-Haken für Seilsystem

S-Hook for cable system
Crochet en S pour système de corde

3309 ... 000 1 VE = 12 Stück



101 Chromfarbig

DUSCHVORHANG-RINGE

Shower curtain rings
Anneaux pour rideau de douche



000 Glasklar
100 Weiß
657 Tanne



766 Türkis
789 Dunkelblau
926 Schwarz

(Innendurchmesser = 5 cm)
(inner diameter = 5 cm)
(diamètre intérieur = 5 cm)

0268 ... 000
1 VE = 12 Stück / unit / unités



DV-RINGE SILBER

Shower curtain rings, silver
Anneaux d'argent pour rideau de douche



124
Silber

(Innendurchmesser = 5 cm)
(inner diameter = 5 cm)
(diamètre intérieur = 5 cm)

3331 ... 000
1 VE = 12 Stück / unit / unités



DV-RINGE BOCCIA

Shower curtain rings
Anneaux pour rideau de douche



117
Chrom

3332 ... 000
1 VE = 12 Stück / unit / unités



Zum Befestigen des
Duschvorhangs an der
Wand bzw. Duschkabine

To fix the shower curtain on
the wall or shower cubicle
Fixer le rideau de douche au
mur ou cabine de douche

KLAMMERN

Shower curtain clips
Pincés à rideau de douche



000 Glasklar
100 Weiß

0279 ... 000
1 VE = 2 Stück / unit / unités

SCHIENENSYSTEM MIT GLEITERN für Dusche und Badewanne

RAIL SYSTEM WITH SLIDERS for shower and bath

SYSTÈME DE RAIL AVEC ROULETTES pour douche et baignoire



Keine Ringe erforderlich! Einfach den Duschvorhang an die integrierten Gleiter anknüpfen. Fertig!

Besonders geeignet für alle textilen Duschvorhänge von Kleine Wolke.

No rings necessary! All you have to do is attach the shower curtain to the integrated sliders. Finished!

Particularly suitable for all textile shower curtains by Kleine Wolke.

Pas besoin d'anneaux! Il suffit de les boutonner aux roulettes intégrées. Et c'est fini! **Convient en particulier pour tous les rideaux de douche textiles de Kleine Wolke.**

WINKELSCHIENE

Angle bracket
Rail d'angle

Montagebeispiele:

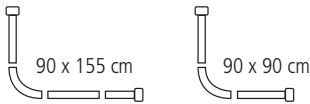
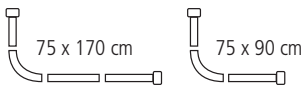

3336 100 019
75 x 170 cm



Verkürzung durch Absägen möglich

Shortening possible by sawing off
Raccourcissement possible par coupe à la scie

inkl. 16 Gleiter
incl. 16 gliders
incl. 16 glisseurs



100 Weiß



Deckenhalterung empfohlen

Ceiling mount kit recommended.
Kit de montage plafond recommandé.

FEDERSCHIENE

Rail. Adjustable by inside spring.
Tringle à ressort

Nur auf gewünschte Breite ausziehen und einspannen.

Simply pullout to desired length and clamp into position.

Trier à la largeur adéquate, puis comprimer et relâcher à l'endroit choisi.

3335 100 014
75-125 cm

3335 100 034
125-220 cm



Verkürzung durch Absägen möglich

Shortening possible by sawing off
Raccourcissement possible par coupe à la scie

inkl. 12 Gleiter
incl. 12 gliders
incl. 12 glisseurs



100 Weiß



DECKENHALTERUNG

für Duschvorhangschienen

Suspension rod for fixing to ceiling
Suspension à barre au plafond



Verkürzung durch Absägen möglich

Shortening possible by sawing off
Raccourcissement possible par coupe à la scie

3337 100 024
60 cm

100 Weiß



ERSATZGLEITER

Additional gliders
Glisseurs supplémentaires



3338 100 970
5 Stück / 5 pieces / 5 pièces

100 Weiß

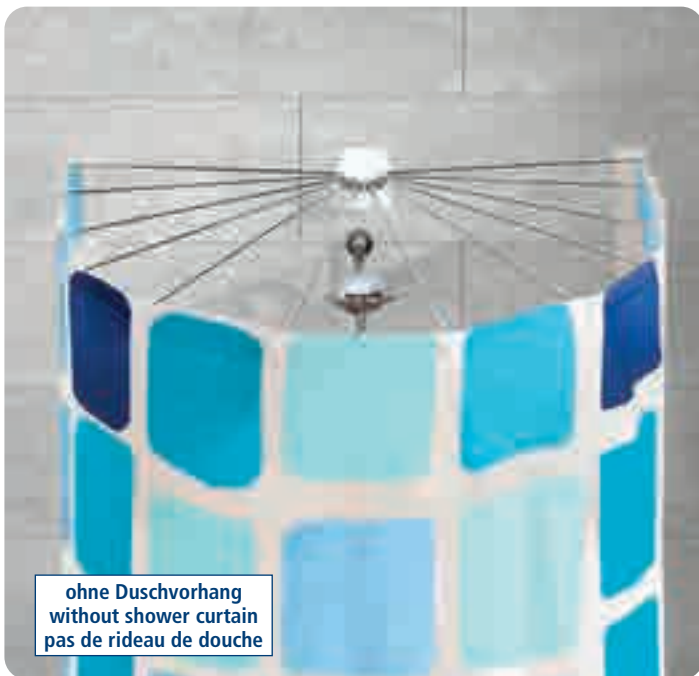

ohne Duschvorhang
without shower curtain
pas de rideau de douche

BIG SPIDER

Duschvorhang-Spinne mit 12 Armen

Passt für jeden Duschvorhang
(180 x 200 cm) von Kleine Wolke

„Spider“ shower curtain frame with 12 arms
Support „araignée“ pour rideau de douche
avec 12 bras

Fits any Kleine Wolke shower curtain
(180 x 200 cm)

Compatible avec tous les rideaux de
douche Kleine Wolke (180 x 200 cm)



100 Weiß

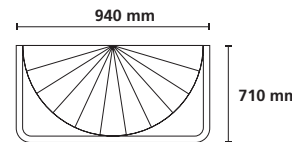

3325 ... 000



SPIDER

Praktische Duschvorhang-Kabine
mit Vinyl-Duschvorhang 200 x 170 cm.

Usefull shower curtain cubicle with vinyl
curtain 200 x 170 cm.
Cabine pliante utile à rideau avec PVC-rideau
de douche 200 x 170 cm.

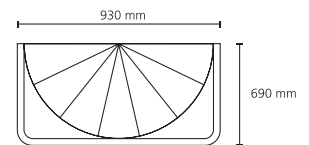

100 (mit DV Weiß)
0382 ... 000
DV-Set



SPIDER ERSATZ-DUSCHVORHANG

Replacement shower curtain
Rideau de douche de remplacement

100% VINYL



wasserdicht
waterproof
étanche à l'eau



100 Weiß

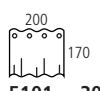

5101 ... 303

DUSCHROLLO INDIVIDUELL

Shower roller blind
Store de douche

8 modische Duschrollo-Designs aus 100% Vinyl

- Abrollkordel links oder rechts montierbar
- Designs flexibel austauschbar
- einfache Montage
- platzsparend
- magnetisches Beschwerungsband im Saum
- offene Kasette verhindert Schimmelbildung

8 trendy shower blind designs, 100% Vinyl

- side pull installable left or right side
- designs flexibly interchangeable
- easy installation
- space-saving
- magnetic strip in the hem
- open cartridge prevents mould formation

8 décors tendance de store de douche, 100% Vinyl

- cordelette montable à gauche ou à droite
- designs échangeables
- montage facile
- peu encombrant
- rubant magnétique alourdissant dans l'ourlet
- caisson ouvert défavorable à la formation de moisissure



So funktioniert's: That's how it works: / Ça fonctionne comme ça:

A Leerkassette
Empty cartridge
Le caisson

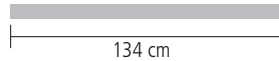

3320 ... 746
Leerkassette



100 Weiß

*Shower roller blind is retracted into the shaft
*Les Store de douche est inséré dans l'arbre

+

B Duschrollo
Shower roller blind
Store de douche

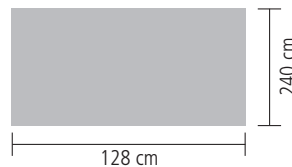

3321 ... 747
Duschrollo

Alle Designs
all designs / tous les modèles

100% VINYL



108 Milky
Duschrollo Design 1



100 Weiß
Duschrollo Design 3



116 Clear
Duschrollo Design 4



110 Grau
Duschrollo Design 6



721 Blue
Duschrollo Design 8



351 Kupfer
Duschrollo Design 10



114 Schneeweiß
Duschrollo Design 11



109 Weiß
Duschrollo Design 12

ECKDUSCHROLLO

Corner shower roller blind
Store de douche enangle

Komplett mit 2 Kassetten und passenden Duschrollo

- in 3 modischen Designs verfügbar
- Eckstück links oder rechts montierbar
- einfache Montage
- platzsparend
- magnetisches Beschwerungsband im Saum
- offene Kassette verhindert Schimmelbildung

Complete with 2 cartridges and matching shower blinds

- 3 trendy designs available
- corner piece installable left or right side
- easy installation
- space-saving
- magnetic strip in the hem
- open cartridge prevents mould formation

Complet avec 2 caissons et les stores assortis

- trois décors disponibles
- angle montable à gauche ou à droite
- montage facile
- peu encombrant
- rubant magnétique alourdissant dans l'ourlet
- caisson ouvert défavorable à la formation de moisissure



Alle Designs
all designs / tous les modèles

100% VINYL

3319 ... 745
Eckduschkassette

Leerkassetten
Empty cartridge
Le caisson

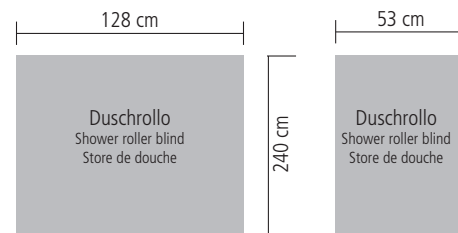
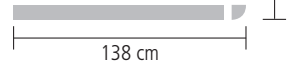

108 Milky
Eckduschkassette Design 1



100 Weiß
Eckduschkassette Design 3



110 Grau
Eckduschkassette Design 6

SCHMALES DUSCHROLLO

Slim shower roller blind
Store de douche étroit

Alle Designs
all designs / tous les modèles

100% VINYL

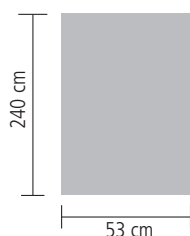

Zum Austausch am
Eckduschkassette / kurze
Seite

For interchanging with bay-style
shower roller blind/ short edge
Pour remplacement sur le store de
douche d'angle/côté court.

3324 ... 737
Schmales Duschkassette



108 Milky
Schmales Duschkassette
Design 1



100 Weiß
Schmales Duschkassette
Design 3



110 Grau
Schmales Duschkassette
Design 6

Sicherheits- einlagen

Safety inserts
Tapis anti-dérapants

Sicherheitseinlagen

- Ausgewogenes Verhältnis zwischen Design, Komfortanspruch und Sicherheitsaspekten
- Qualitativ hochwertiges PVC oder PVC-freies Material wie z.B. Kautschuk oder TPE
- Saugnäpfe sorgen für die erforderliche, einwandfreie Haftung auf dem Wannensboden
- Moderne Uni-Modelle sowie eine große Auswahl bedruckter Einlagen

Safety inserts

- perfect balance between design, comfort requirements and safety aspects
- high-quality PVC or PVC-free material e.g. rubber or TPE
- suction cups ensure the necessary, perfect adhesion to the bottom of the tub
- modern plain models as well as a large selection of printed inserts

Tapis anti-dérapants

- un rapport équilibré entre la création, le confort et la sécurité
- en PVC ou matériau sans PVC de qualité supérieure comme p. ex. du caoutchouc ou des TPE
- Les ventouses garantissent l'adhérence obligatoire et pratique au fond de la baignoire
- modèles unis modernes ainsi qu'une large sélection d'empiecements imprimés



SEITE 246-250

Sicherheitseinlagen Uni / Solid non-slip mats / Tapis antiderapants Uni



AROSA 246



CASABLANCA 246



GATTY 246

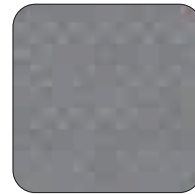

FORMOSA 247



HONEY 247



IVY 247



JAVA PLUS 248



JOY 248

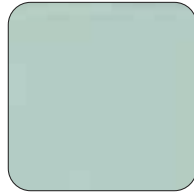

RUBY 248



SAMOA PLUS 249



WELLNESS 249



SIGN 250



ANTI-RUTSCH
STICKER 250

SEITE 251-255

Sicherheitseinlagen mit Motiv / Non-slip mats with design / Tapis antiderapants à motifs



ANCHOR 251



BEACH 251



BORKUM 251

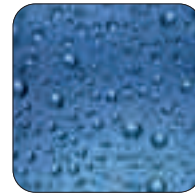

BUBBLE 252



CHARLIE 252



DAHLIA 252



FLORES 253



GARDEN 253



JACKSONS 253



MARBLE 254



ROSEMARIE 254



SARDINAS 254



SAVANNAH 255

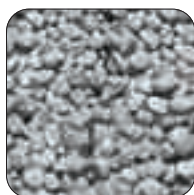

STEPSTONE 255



PILLOW 255

MINIS / DEKORE SEITE 256-257

Minis / Deco-Accessories

AROSA

PVC



100 Weiß **201** Beige **720** Blau **901** Anthrazit **923** Möwe



0221 ... 008
ca. 32 x 22 cm



0221 ... 002
ca. 55 x 55 cm



0221 ... 001
ca. 36 x 92 cm



CASABLANCA

PVC



Ideal geeignet für bodengleiche Duschen
Ideal for level showers
Idéal pour douches à niveau

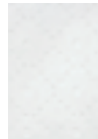

100
Weiß



4113 ... 051
ca. 75 x 75 cm



GATTY

Polypropylen / TPE

PVC frei
PVC free / sans PVC



Ideal auch für den Outdoor-Bereich

Also ideal for outdoors
Parfaitement adapté à l'extérieur



100
Weiß



926
Schwarz



4154 ... 071
ca. 54 x 54 cm



4154 ... 073
ca. 39 x 68 cm

Kann individuell zugeschnitten werden
Can be individually tailor-made
Peut être découpé individuellement

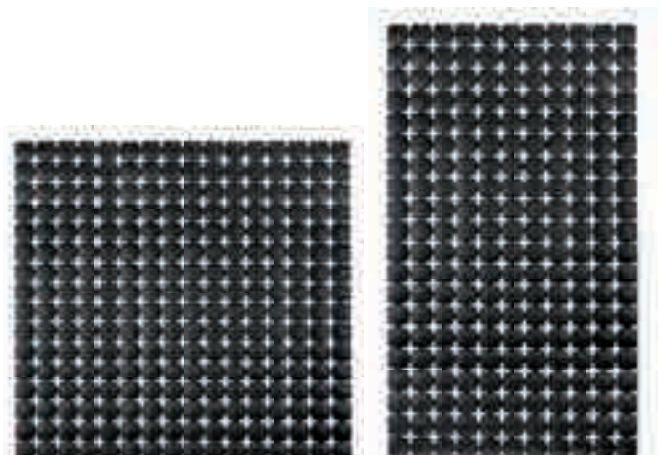
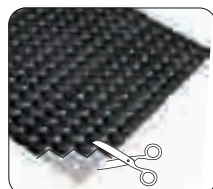



FORMOSA

Kautschuk **PVC frei**



100
Weiß



600
Grün



746
Stahlblau

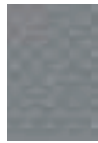

901
Anthrazit



4100 ... 118
ca. 53 x 53 cm



4100 ... 107
ca. 40 x 90 cm

HONEY

PVC

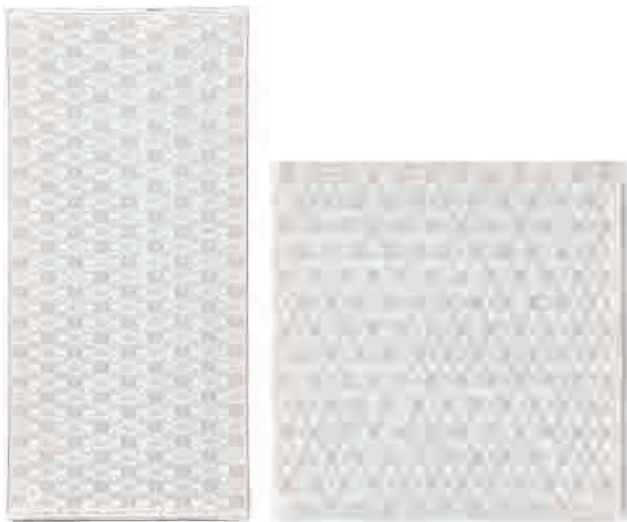

116
Clear



5352 ... 002
ca. 55 x 55 cm



5352 ... 009
ca. 36 x 80 cm

IVY

PVC

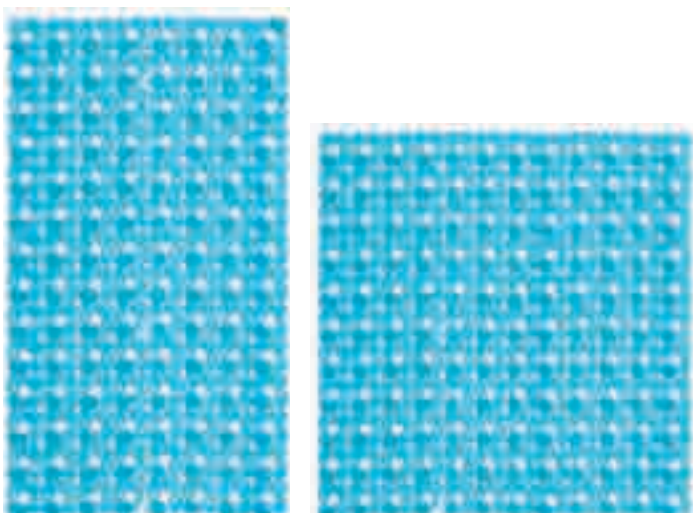

100
Weiß



116
Clear



766
Türkis



4122 ... 071*
ca. 54 x 54 cm



4122 ... 072*
ca. 39 x 69 cm

*In gerollter Aufmachung

JAVA-PLUS

PVC frei TPE
PVC free / sans PVC

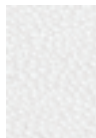

100
Weiß



0241 ... 002
ca. 55 x 55 cm



0241 ... 009
ca. 36 x 92 cm

- **Hohe Rutschfestigkeit**
High level of slip resistance
Qualité antidérapante élevée
- **Extreme Haltbarkeit**
Extremely durable
Durabilité extrême
- **Höchster Komfort**
Maximum comfort
Confort très élevé



JOY

PVC



100
Weiß



4301 ... 008
ca. 32 x 22 cm



4301 ... 002
ca. 55 x 55 cm



4301 ... 005
ca. 36 x 72 cm

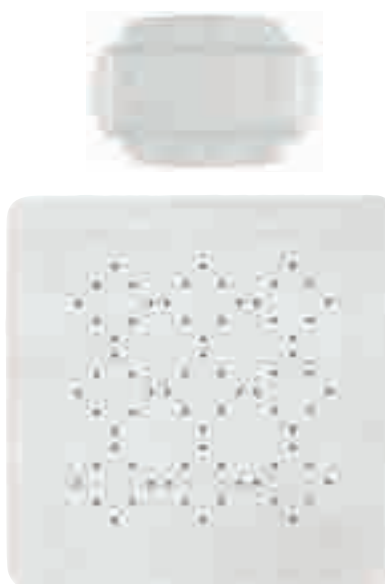

RUBY

PVC frei Kautschuk
PVC free / sans PVC Natural Rubber
Caoutchouc



RUBY ist ein umweltfreundliches Naturprodukt

RUBY is an environmentally friendly natural product.
RUBY est un respectueux de l'environnement produit naturel



146
Silbergrau



649
Opal



742
Wasserblau



4129 ... 118
ca. 53 x 53 cm



4129 ... 036
ca. 35 x 75 cm



SAMOA-PLUS

TPE

PVC frei
PVC free / sans PVC



100
Weiß



0204 ... 002
ca. 55 x 55 cm



0204 ... 001
ca. 36 x 92 cm

WELLNESS

PVC



100
Weiß

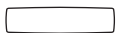

4120 ... 013
ca. 36 x 145 cm

1| Polster zum Liegen
Tub cushion
Rembourrage pour s'allonger

2| Polster als Sitzstütze
Support cushion
Rembourrage pour s'asseoir

3| Verlängertes Nackenpolster
Long neck cushion
Verlängertes
Rembourrage pour le dos allongé

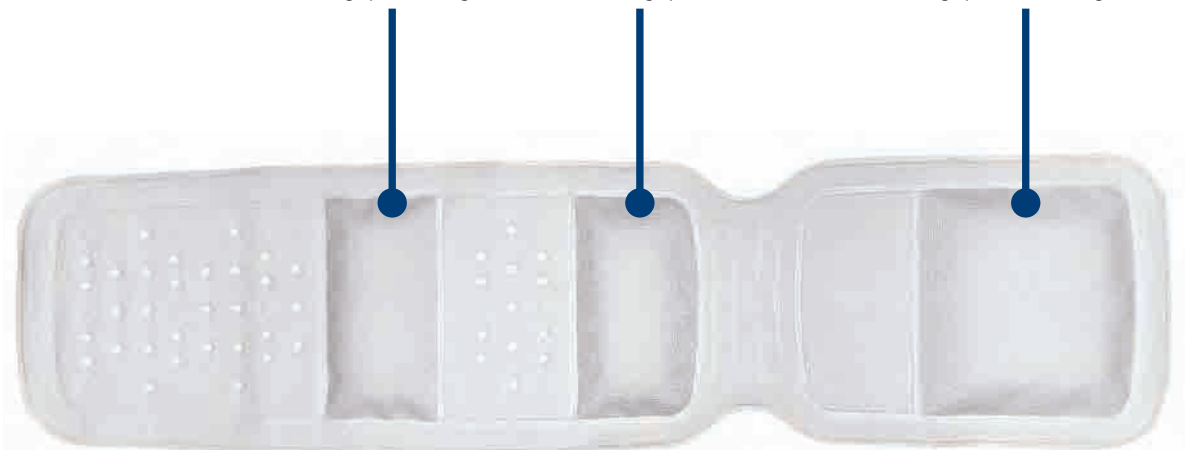

SIGN

PVC



116
Clear



124
Silber

Kann individuell zugeschnitten werden
Can be individually tailor-made
Peut être découpé individuellement



4384 ... 002
ca. 55 x 55 cm



4384 ... 009
ca. 36 x 80 cm

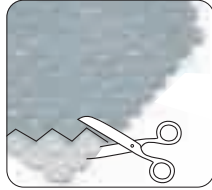

ANTI-RUTSCH STICKER

Anti-slip stickers for the shower and bath
Pastilles antidérapantes pour douche et baignoire

PVC

QUADRO Sticker



100
Weiß

4155 ... 976
Set 18-teilig / 18 parts / 18 parties
6 x 10,5 cm x 10,5 cm;
6 x 7,9 cm x 7,9 cm;
6 x 4,6 cm x 4,6 cm

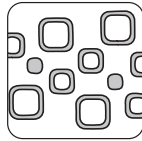
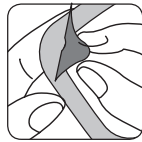

DAISIES Sticker



116
Clear

4128 ... 976
Set 18-teilig / 18 parts / 18 parties
9 x Ø 10,5 cm + 9 x Ø 4,5 cm

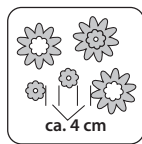

STRIPES Sticker



116
Clear

4111 ... 948
Set 6-teilig / 6 parts / 6 parties
Stück / piece / pièce: ca. 25 x 1,8 cm

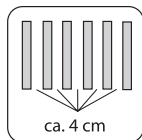

TAPE Anti-Rutsch-Band



116
Clear

4144 ... 060
Rolle, individuell zuschneidbar
Roll, individually cut to size
Rôle, coupé individuellement
5 m x 2 cm

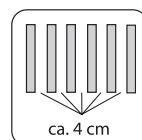
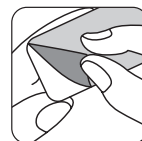

- sicherer Halt
safe grip
stabilité assurée
- selbstklebend
self adhesive
auto-adhésif
- leicht ablösbar
easily removable
facilement détachable

ANCHOR

PVC



789
Dunkelblau
*100 Weiß



5366* ... 008
ca. 32 x 22 cm



4107 ... 002
ca. 55 x 55 cm



4107 ... 001
ca. 36 x 92 cm

BEACH

PVC



Wanneneinlage
auch in
36x72 cm
erhältlich

Also available in size 36 x 72 cm
Aussi disponible en taille 36 x 72 cm

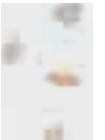

148
Multicolor
*100 Weiß



5366* ... 008
ca. 32 x 22 cm



4300 ... 002
ca. 55 x 55 cm



4300 ... 005
ca. 36 x 72 cm



4300 ... 001
ca. 36 x 92 cm

BORKUM

PVC

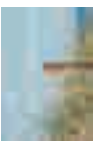
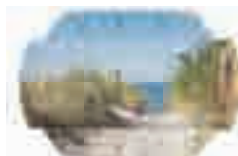

148
Multicolor



4159 ... 008
ca. 32 x 22 cm



4159 ... 002
ca. 55 x 55 cm



4159 ... 001
ca. 36 x 92 cm

BUBBLE

PVC



769
Marineblau

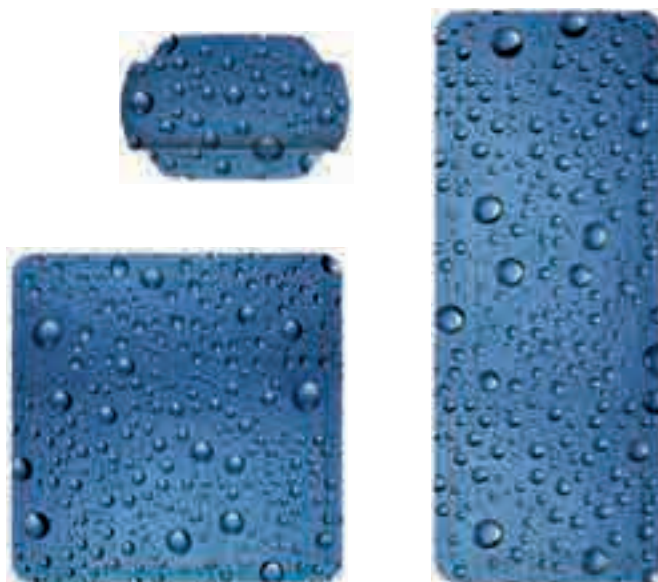
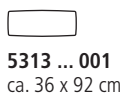
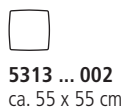
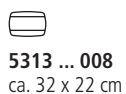

CHARLIE

PVC

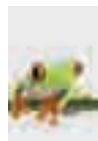

625
Maigrün
*100 Weiß

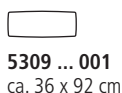
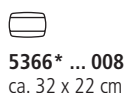

DAHLIA

PVC



851
Lavendel

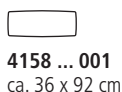
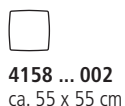
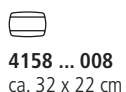

FLORES

PVC



148
Multicolor



4148 ... 008
ca. 32 x 22 cm



4148 ... 002
ca. 55 x 55 cm



4148 ... 001
ca. 36 x 92 cm

GARDEN

PVC



148
Multicolor
*100 Weiß



5366* ... 008
ca. 32 x 22 cm



4147 ... 002
ca. 55 x 55 cm



4147 ... 001
ca. 36 x 92 cm

JACKSONS

PVC



190
Weiß Schwarz
*100 Weiß



5366* ... 008
ca. 32 x 22 cm



4153 ... 002
ca. 55 x 55 cm



4153 ... 001
ca. 36 x 92 cm

MARBLE

PVC



901
Anthrazit



4102 ... 008
ca. 32 x 22 cm



4102 ... 002
ca. 55 x 55 cm



4102 ... 001
ca. 36 x 92 cm



ROSEMARIE

PVC



428
Bordeaux



4132 ... 008
ca. 32 x 22 cm



4132 ... 002
ca. 55 x 55 cm



4132 ... 001
ca. 36 x 92 cm



SARDINAS

PVC



148
Multicolor
*100 Weiß



5366* ... 008
ca. 32 x 22 cm



4160 ... 002
ca. 55 x 55 cm



4160 ... 001
ca. 36 x 92 cm



SAVANNAH

PVC



148
Multicolor
*100 Weiß



5366* ... 008
ca. 32 x 22 cm



4151 ... 002
ca. 55 x 55 cm



4151 ... 001
ca. 36 x 92 cm

STEPSTONE

PVC

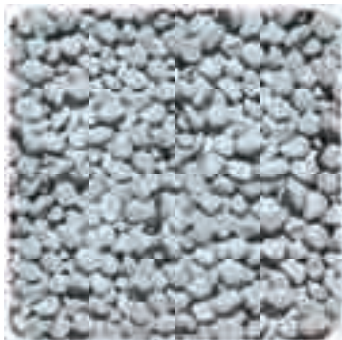
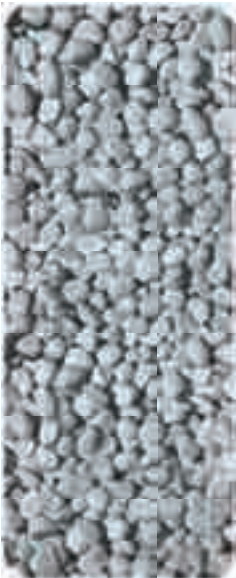

189
Grau

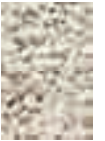

202
Natur



4387 ... 008
ca. 32 x 22 cm



4387 ... 002
ca. 55 x 55 cm



4387 ... 001
ca. 36 x 92 cm

PILLOW UNIVERSALKISSEN

PVC



Die ideale Ergänzung zu allen
Sicherheitseinlagen mit Motiv

The ideal complement to all safety
inserts with motifs.

L'atout idéal pour compléter tous
les tapis antidérapants à motif



100
Weiß



5366 ... 008
ca. 32 x 22 cm

FLIP

PVC



791
Himmelblau

4379 ... 969
Set 4-teilig / 4 parts / 4 parties



JELLY

PVC



625
Maigrün

4380... 969
Set 4-teilig / 4 parts / 4 parties



SHARKY

PVC



901
Anthrazit

5364 ... 969
Set 4-teilig / 4 parts / 4 parties





568
Sunshine

4382... 969

Set 4-teilig / 4 parts / 4 parties

GUPPI

PVC



Farblich sortiert
(2 x 3 Farben)

Sorted by colours
(2 x 3 colours)

Couleurs assorties
(2 x 3 couleurs)

172
Marine/Türkis

4209 ... 948
Set 6-teilig / 6 parts / 6 parties

MINI MOBY

PVC



Farblich sortiert
(3 x 2 Farben)

Sorted by colours
(3 x 2 colours)

Couleurs assorties
(3 x 2 couleurs)

720
Blau

4131 ... 948
Set 6-teilig / 6 parts / 6 parties

MUSCHEL

PVC



114
Schneeweiß

4209 ... 948
Set 6-teilig / 6 parts / 6 parties

SASSOLINO

PVC



100
Weiß



139
Rauchgrau

4123 ... 948
Set 6-teilig / 6 parts / 6 parties

EINSTIEGSPREISLAGEN- ENTRY PRICE LEVELS CATÉGORIES DE PRIX DE DÉPART

Die kostengünstige Ergänzung zu unserer Badkollektion

- attraktive, moderne Designs
- ideal für Zweitplatzierung

The cost-effective complement to our bathroom collection

- attractive, modern designs
- ideal as secondary offering

Le complément économi- que de notre collection de salle de bain

- dessins attrayants et modernes
- idéal pour la deuxième place



ÜBERSICHT CONTENT / CONTENU

BADTEPPICHE

BATH RUGS / TAPIS DE BAIN

FINN	259
SANDY	259
TAMMY	259

ACCESSOIRES

ACCESSORIES / ACCESSOIRES

MATCH	260
PLENTY	260

KOSMETIKEIMER

COSMETIC BINS / POUCELLE À COSMÉTIQUES

MATCH	260
ONE	261

DUSCHVORHÄNGE UND ZUBEHÖR

SHOWER CURTAINS / RIDEAUX DE DOUCHE

MOTION	261
PROMO	261

ZUBEHÖR

FITTINGS / GARNITURE

DUSCH-SET	262
DUSCHROLLO	262

SICHERHEITSEINLAGEN

SAFETY INSERTS / TAPIS ANTI-DÉRAPANTS

CALYPSO	263
FOOT	263
SOFTY	263

SANDY



MATCH



ONE



MOTION

Neutral

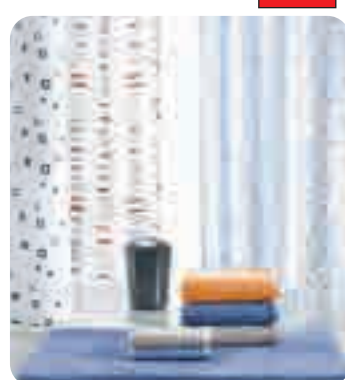

SOFTY

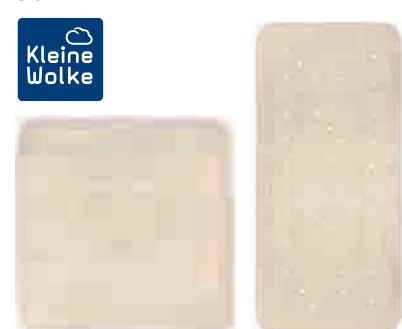

FINN



100
Weiß

146
Silbergrau



202
Natur

905
Schiefer

100% Baumwolle / Cotton / Coton



Für Fußbodenheizung
geeignet

Florhöhe (mm)
Pile height
Hauteur mèches

10

Praktische Aufmachung in gerollter Form

Practical presentation in rolled form
Présentation pratique sous forme roulée



5534 ... 433
ca. 50 x 60 cm



5534 ... 207
ca. 50 x 80 cm

SANDY



201
Beige



913
Nebel

100% Polyester



Für Fußbodenheizung
geeignet

Florhöhe (mm)
Pile height
Hauteur mèches

6 12

Praktische Aufmachung in gerollter Form

Practical presentation in rolled form
Présentation pratique sous forme roulée



5537 ... 433
ca. 50 x 60 cm



5537 ... 207
ca. 50 x 80 cm

TAMMY



100
Weiß

453
Rubin



600
Grün

766
Türkis

100% Polyester



Für Fußbodenheizung
geeignet

Florhöhe (mm)
Pile height
Hauteur mèches

12

Praktische Aufmachung in gerollter Form

Practical presentation in rolled form
Présentation pratique sous forme roulée



5535 ... 433
ca. 50 x 60 cm



5535 ... 207
ca. 50 x 80 cm

MATCH

AS Kunststoff / AS plastic / AS plastique



Bürstenkopf Ø 7,3 cm
5047 185 868
Schwarz Weiß

Bürstenkopf Ø 7,3 cm
5047 926 868
Schwarz



100
Weiß

201
Beige

977
Platin



***8482 ... 852**
Zahnputzbecher
Tumbler
Gobelet de brosse à dents

*VE = 2 Stück / 2 pieces / 2 unités



***8482 ... 854**
Seifenspender
Soap dispenser
Dispenseur de savon



8482 ... 856
WC-Bürstengarnitur
Toilet brush holder
Porte-brosse de toilette

PLENTY

Polypropylen



100
Weiß

901
Anthrazit



***5850 ... 852**
Zahnputzbecher
Tumbler
Gobelet de brosse à dents

*VE = 6 Stück / 6 pieces / 6 unités



***5850 ... 854**
Seifenspender
Soap dispenser
Dispenseur de savon



***5850 ... 856**
WC-Bürstengarnitur
Toilet brush holder
Porte-brosse de toilette

MATCH

AS Kunststoff / AS plastic / AS plastique

Schwingdeckeleimer

Swing bin

Poubelle à couvercle basculant



100
Weiß

201
Beige

977
Platin



Inhalt 5 Liter
Content 5 litres
Contenu 5 litres

8484 ... 858
ca. 18 x 24,3 cm

VE = 2 Stück / 2 pieces / 2 unités



ONE

Metall / Metal / Métal

Treterimer
Pedal bin
Poubelle à pédale



100
Weiß



202
Natur



431
Rouge



649
Opal



926
Schwarz



977
Platin



Inhalt 3 Liter
Content 3 litres
Contenu 3 litres

8058 ... 858
ca. 16,8 x 25 cm

Beispielabbildungen
Examples / Exemples



MOTION

TEXTIL 100% Polyester

**10 Duschvorhänge, sortiert,
mit je 12 weißen DV-Ringen.**

Unterschiedliche Designs

10 Shower curtains, sorted,
each with 12 white shower curtain rings.

Different designs

10 Rideaux de douche, assortis, munis chacun
de 12 anneaux de rideau de douche blancs.

Différents modèles



Wasserabweisend
With water-repellent finish
Traitement hydrofuge



4947 000 305
ca. 180 x 200 cm

Beispielabbildungen
Examples / Exemples



PROMO

ÖKOPLAST 100% PEVA PVC-frei

**10 Duschvorhänge, sortiert,
mit je 12 weißen DV-Ringen.**

Unterschiedliche Designs

10 Shower curtains, sorted,
each with 12 white shower curtain rings.

Different designs

10 Rideaux de douche, assortis, munis chacun
de 12 anneaux de rideau de douche blancs.

Différents modèles



Ökoplant-Duschvorhänge sind PVC-frei. Sie werden ohne Zusätze von Chloriden und Cadmium gefertigt und sind recyclingfähig.

Ökoplant shower curtains are PVC-free. They are manufactured without any chloride or cadmium additives and are recyclable.

Les rideaux de douche Ökoplant ne contiennent pas de PVC. Ils sont fabriqués sans addition de chlorures ni de cadmium et sont recyclables.



Wasserdicht
Waterproof
Étanche à l'eau



4837 000 305
ca. 180 x 200 cm

DUSCH-SET

100% VINYL



Komplett-Paket in 2 Größen

Complete package in 2 sizes
Forfait complet en 2 tailles

3313 Set 3-tlg. (920)

- 1 > DV-Stange 75-125 cm
- 2 > Duschvorhang 120 x 200 cm
- 3 > 8 DV-Ringe

3313 100 920

Dusch-Set klein, weiß

3313 Set 3-tlg. (921)

- 1 > DV-Stange 125-220 cm
- 2 > Duschvorhang 180 x 200 cm
- 3 > 12 DV-Ringe

3313 100 921

Dusch-Set groß, weiß



Wasserdicht
Waterproof
Étanche à l'eau



1 DV-Stange
Universal rod
Barre universelle

2 DV-Ringe
Shower curtain rings
Anneaux pour rideau
de douche

3 Duschvorhang
Shower curtain
Rideau de douche

DUSCHROLLO

Shower roller blind
Store de douche

100% VINYL

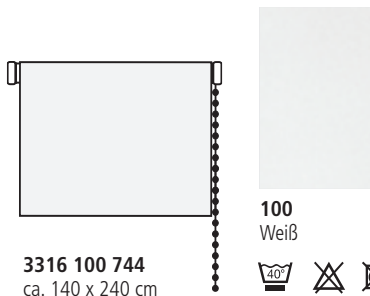

100
Weiß

3316 100 744
ca. 140 x 240 cm



Seitliche Kürzung möglich
Sides can be shorted
Raccourcissement latéral possible



Wasserdicht
Waterproof
Étanche à l'eau



CALYPSO

PVC



100
Weiß

201
Beige

669
Kiwi



726
Lagoon

732
Kobaltblau

733
Krokusblau



977
Platin



4325 ... 917
Set 2-tlg.
32 x 22 cm
36 x 72 cm



4325 ... 002
ca. 55 x 55 cm



FOOT

Kautschuk

PVC-frei

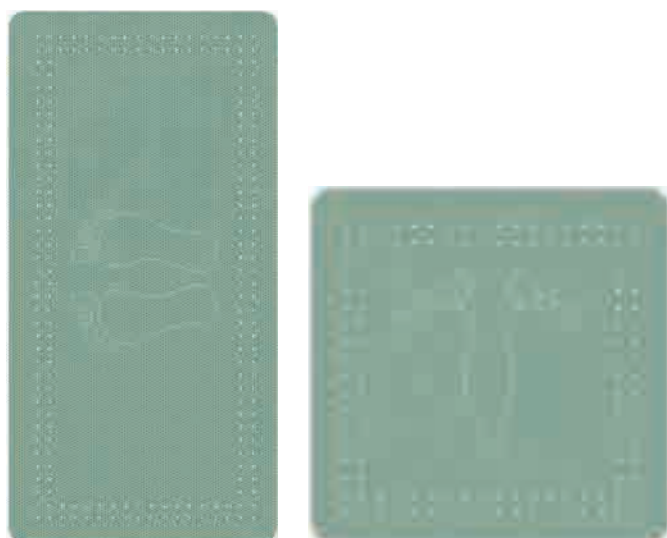

189
Grau

226
Sandbeige

615
Kiwigrün



685
Maledivia

720
Blau

905
Schiefer



4388 ... 002
ca. 55 x 55 cm



4388 ... 005
ca. 36 x 72 cm



SOFTY

PVC



114
Schneeweiß

202
Natur



723
Azur

905
Schiefer

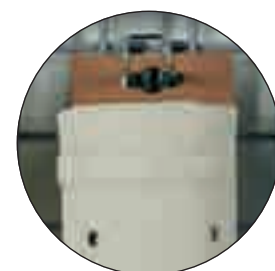

In gerollter Aufmachung
Rolled packaging
Emballages roulées



4146 ... 002
ca. 55 x 55 cm



4146 ... 009
ca. 36 x 80 cm



POS Excellence

VERMARKTUNGSKONZEPT

Marketing concept

Concept de commercialisation

3er VARIO mit
Badteppichstange
und Kopfregal



DESIGNWELT
DESIGNTHEME / THÈME DESIGN

EINFACH MEER



Abmessungen (B x H x T)

Dimensions

268 x 145 x 80 cm

POS EXCELLENCE

Ihre Verkaufsfläche exakt und individuell auf Ihre Wünsche zugeschnitten – das bieten Ihnen die flexiblen Shopsysteme von Kleine Wolke.

Für Bestückungen auf der Freifläche und in der Rückwand haben wir die richtigen Warenträger und schaffen mit der attraktiven Umsetzung von aktuellen Farb- und Themenwelten ein neues, emotionales Einkaufserlebnis am POS.

Gerne gestalten wir auch Ihre Flächenplanung – sprechen Sie uns an.

POS EXCELLENCE

Your retail space, tailored exactly to your wishes – that is what the flexible shop system by Kleine Wolke offers you. We have the right product displays for the placement of goods on the shop floor or against the back wall, and we use the attractive implementation of current colour themes to create a new, emotional shopping experience at the POS.

We would love to design your space too – talk to us about it!

POS EXCELLENCE

Votre espace de vente personnalisé exactement selon vos désirs – voilà ce que vous offre les systèmes d'agencement modulables Kleine Wolke. Pour équiper des espaces libres ou des parois murales, nous disposons des supports appropriés et créons ainsi une ambiance particulière dans votre point de vente en utilisant des thèmes et des couleurs actuels.

Nous pouvons également planifier l'agencement de votre boutique – contactez-nous!



Abmessungen (B x H x T)

Dimensions

270 x 271 x 69 cm



Warenträgerkonzept Shop VARIO

Maximale Flexibilität und Funktionalität – das bietet Shop VARIO designed by Kleine Wolke. Das modulare System in den Farbtönen Anthrazit und Weiß in Kombination mit edlem Eichenholz-Dekor kann individuell mit unterschiedlichsten Bauteilen und Emotionals erweitert werden und bietet so eine attraktive, zugeschnittene Präsentation unterschiedlichster Warengruppen für ein emotionales Einkaufserlebnis am POS. Mit der Flächenplanung in Farb- und Themenwelten sorgen wir für Zusatzumsatz und Ertragssteigerung.

Display Concept Shop VARIO

Maximum flexibility and functionality – that is what Shop VARIO, designed by Kleine Wolke, has to offer. The modular system, in the colours anthracite and white, can be expanded and added to with the use of different components and motifs, and therefore offers an attractive way to present even the most varying product groups which is geared towards customer needs, for an emotive shopping experience at the POS. With an area plan in an appropriate colour scheme and theme, displaying products together encourages impulse purchases of interrelated products: great for additional turnover and an increase in earnings.

Display Concept Shop VARIO

Flexibilité et fonctionnalité maximum – c'est le concept du Shop VARIO designed by Kleine Wolke. Le système modulaire en couleurs anthracite et blanc peut être élargi et complété individuellement avec différents éléments et objets «émotion», et offre une présentation de différentes catégories de produits attractive et adaptée aux besoins du client pour une expérience d'achat agréable en point de vente. Grâce aux différents thèmes et couleurs proposés, l'agencement de votre boutique fera naître chez vos clients des envies d'achats spontanés et groupés, ce qui permettra d'augmenter vos recettes et d'améliorer votre rendement.

SHOPWELT RÜCKWAND

POS RÜCKWAND

Rear wall
Panneau arrière



DESIGNWELT
DESIGNTHEME / THÈME DESIGN
EINFACH MEER



Abmessungen (B x H x T)

Dimensions

520 x 271 x 69 cm

POS RÜCKWAND

Rear wall
Panneau arrière



DESIGNWELT
DESIGNTHEME / THÈME DESIGN
NEUE ERNTE





3er VARIO mit
Badteppich-Schrägabhänger

VARIO with bath rug sloping hanger
VARIO avec cintre diagonal pour tapis de bain

DESIGNWELT
DESIGNTHEME / THÈMEDESIGN
NEUE ERNTE



Abmessungen (B x H x T)
Dimensions
160 x 145 x 80 cm

3er VARIO
mit Badteppich-Schrägabhänger

VARIO with bath rug sloping hanger
VARIO avec cintre diagonal pour tapis de bain

DESIGNWELT
DESIGNTHEME / THÈMEDESIGN
DAYDREAM



Abmessungen (B x H x T)
Dimensions
235 x 145 x 80 cm



3er VARIO mit
Badteppich-Schrägabhänger

VARIO with bath rug sloping hanger
VARIO avec cintre diagonal pour tapis de bain

DESIGNWELT
DESIGNTHEME / THÈME DESIGN
SCHÖN HIER



Abmessungen (B x H x T)
Dimensions
235 x 145 x 80 cm



BADTEPPICHPRÄSENTER

Bath mat display unit
Présentoir pour tapis de bain

Abmessungen (B x H x T)
Dimensions
130 x 148 x 50 cm

Die Uni-Präsentation - produktübergreifend auf den Punkt gebracht

Unser Uni-Programm überzeugt durch klare Formsprache und produktübergreifende Farbgestaltung. Das Konzept lässt sich sowohl auf dem Freiflächenpräseniter als auch in der Rückwand optimal umsetzen.

The solid presentation - straight to the point across all products

Our solid line features attractive clear design vocabulary and colour schemes spanning products. The concepts can be implemented optimally both on a free-standing display and the back wall.

La présentation Uni — en venir au fait pour tous les produits

Notre programme Uni se distingue grâce à son langage des formes clair et à ses choix de couleur concernant tous les produits. Le concept peut être mis en œuvre de manière optimale sur le présentoir et le panneau arrière.

RÜCKWAND



Abmessungen (B x H x T)

Dimensions

375 x 261 x 65 cm

3er VARIO
VARIO
VARIO



Abmessungen (B x H x T)
Dimensions
235 x 145 x 80 cm

Die Eco-Präsentation- Nachhaltigkeit mit starker Fernwirkung

Zur optimalen Präsentation des Eco-Sortiments und für eine schnelle Orientierung des Kunden bieten wir Ihnen einen neu entwickelten, flexiblen Warenträger auf Basis unserer bestehenden Shop-Systeme.

The Eco presentation – sustainability which strikes from a distance

For optimal presentation of the Eco range and for the customer's swift orientation, we offer you a newly developed, flexible goods carrier based on our existing shop systems.

La présentation Eco – le développement durable qui agit à distance

En vue d'une présentation optimale de l'assortiment Eco et de l'orientation rapide du client, nous vous proposons un support de marchandises inédit, flexible, qui s'appuie sur notre système de boutique existant.



Freiflächen-Präsentier Spiegel
Open-space presenter mirror / Présentoir espace libre miroir



Rückwand Spiegel
Rear wall mirror / Panneau arrière miroir



Die optimale Produktpräsentation - flexibel und individuell

Die Warengruppe Spiegel mit unterschiedlichen Anbringungs- und Stellmöglichkeiten lässt sich attraktiv und ansprechend mit Funktionsmustern in einer flexiblen Freiflächen-Platzierung darstellen, als auch in einer optimalen Rückwand-Abwicklung.

Optimum product presentation - flexible and unique

The mirror product group, with its various options for attachments and adjustments, lends itself to being displayed attractively and appealingly with functional models in a flexible open space, or alternatively in a fantastic rear wall arrangement.

La présentation optimale du produit - flexible et individuelle

Le groupe de produits Spiegel avec ses différentes possibilités de mise en place et d'arrangement, est présenté de manière attractive et plaisante grâce au placement des modèles d'exposition sur des espaces libres flexibles ou comme présentation murale optimale.

Die optimale Produktpräsentation – zum Informieren und Testen

Freiflächen-Präsentier Duschrollo

Open-space presenter shower blind
Présentoir espace libre store de douche



Rückwand Duschrollo

Rear wall shower blind
Panneau arrière store de douche



Duschrollo-Präsentation

Egal, ob für Freifläche oder Rückwand – auch für diese Warengruppe hat Kleine Wolke eine perfekt abgestimmte Warenpräsentation mit Anwendungsbeispiel entwickelt.

The optimal product presentation – for information and testing

Shower Blind Presentation

Kleine Wolke has developed the perfect way to present this product group by means of a usage example – be this on the shop floor or the back wall.

La présentation optimale du produit – pour information et test

Présentation store de douche

Qu'ils soient destinés à un espace libre ou à une paroi murale, Kleine Wolke a également développé une présentation harmonieuse avec exemples d'application pour cette catégorie de produits.

Die dreifache Produktpräsentation – passend für jeden Platz

Mit bis zu 3 unterschiedlichen Präsentationsformen stellt Kleine Wolke die Warengruppe der WC-Sitze gekonnt in Szene. Für ein harmonisches POS-Erscheinungsbild, individuell auf Ihre Ansprüche ausgelegt, gibt es diese Warenträger zur Wahl in den Dekoren Anthrazit und Weiß.

Toilet Seat Presentation

With up to 4 different presentation forms, Kleine Wolke knows exactly how to present toilet seats as a product group. For a harmonic POS appearance that is designed individually for your needs, these product displays are available in anthracite, aluminium, white, maple or beech.

Présentation abattants WC

Kleine Wolke met en scène la catégorie des abattants WC à travers 4 choix de présentation différents. Pour obtenir un point de vente individuel et harmonieux correspondant à vos attentes, ces supports sont conçus au choix avec des décors en anthracite, aluminium, blanc, érable ou hêtre.

Querpräsentier

Cross presenter / Présentateur croix

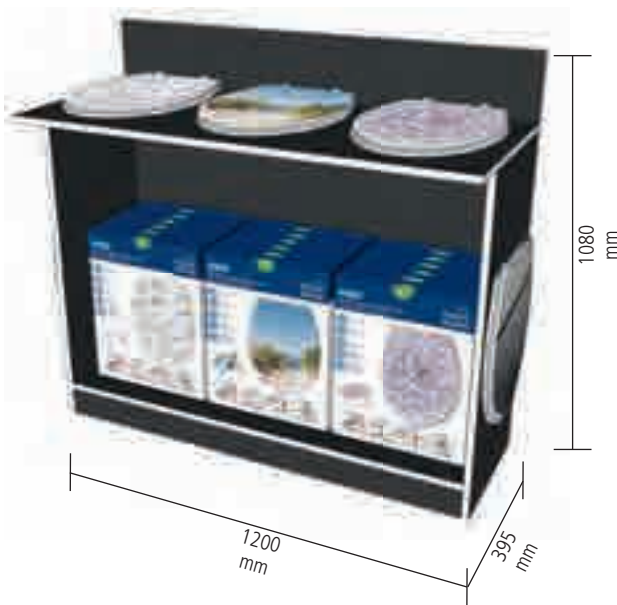

Beispielbestückung Querpräsentier

Sample placement
Exemple d'équipement

Modell Modell Modèle	Farbe Colour Couleur	Anzahl Number Nombre
Borkum	Multicolor	4
Sardinas	Multicolor	4
Dahlia	Lavendel	4
Slate	Schiefer	4
Marble	Anthrazit	4
Ersatz Montageset	Chromfarbig	3
Ersatz Deckelpuffer	Weiß	3

Säule

Pillar / Colonne



Beispielbestückung Säule

Sample placement
Exemple d'équipement

Modell Modell Modèle	Farbe Colour Couleur	Anzahl Number Nombre
Borkum	Multicolor	3
Sardinas	Multicolor	3
Dahlia	Lavendel	3
Garden	Multicolor	3
Blossom	Nelke	3
Flores	Multicolor	3
Marble	Anthrazit	2
Rosemarie	Bordeaux	2
Jacksons	Weiß Schwarz	3
Ersatz Montageset	Chromfarbig	3
Ersatz Deckelpuffer	Weiß	3

Paletten-Präsentier

Pallet presenter / présentateur de palettes



Beispielbestückung Paletten-Präsentier

Sample placement
Exemple d'équipement

Modell Modell Modèle	Farbe Colour Couleur	Anzahl Number Nombre
Uni	Dunkelblau	12
Ersatz Montageset	Chromfarbig	3
Ersatz Deckelpuffer	Weiß	3

PFLEGESYMBOLLE Care symbols / Symboles de soins



Schonwaschgang
Delicate wash cycle
Programme pour textiles fragiles



Trocknen mit reduzierter
thermischer Beanspruchung
Drying with reduced thermal stress
Sécher avec charge thermique réduite



Warm bügeln
Iron warm
Repasser chaud



Fußbodenheizungsg geeignet
Suitable for underfloor heating
Approprié au chauffage de sol



Schonwaschgang
Delicate wash cycle
Programme pour textiles fragiles



Nicht im Wäschetrockner trocknen
Do not dry in a dryer
Ne pas sécher dans le sèche-linge



Mäßig heiß bügeln
Iron moderately hot
Repasser à température moyenne



Spülmaschineng geeignet
Dishwasher-proof
Lavable au lave-vaisselle



Handwäsche
Hand wash
Lavage à la main



Keine chemische Reinigung möglich
No dry cleaning possible
Pas de nettoyage à sec possible



Nicht bügeln
Do not iron
Ne pas repasser



Nicht spülmaschineng geeignet
Not dishwasher-safe
Ne pas va au lave-vaisselle



Nicht bleichen
Do not bleach
Ne pas blanchir

NACHHALTIG DENKEN UND ÖKOLOGISCH HANDELN! THINK SUSTAINABLY AND ACT ECOLOGICALLY! / PENSER DURABLEMENT ET AGIR ÉCOLOGIQUEMENT!



Kollektion aus nachwachsenden Rohstoffen

In der heutigen Zeit sind Nachhaltigkeit und Umweltbewusstsein zentrales Thema in der Gesellschaft. Das **ECO-LIVING-Sortiment** von Kleine Wolke erfüllt alle Anforderungen einer umweltbewussten Kollektion aus nachwachsenden Rohstoffen. Gesundheitsverträgliche Rohstoffe und biologisch abbaubare Fasern werden zu nachhaltigen Produkten gefertigt.

Collection from renewable raw materials

The Kleine Wolke label for environmentally products in the bathroom. The ECO LIVING range from Kleine Wolke meets all the requirements of an eco-conscious collection made from renewable raw materials. Healthy raw materials and biodegradable fibres are made into sustainable products.

Collecte à partir de matières premières renouvelables

Le Kleine Wolke label pour des produits de salle de bains respectueux de l'environnement. Le ECO LIVING de Kleine Wolke remplit toutes les conditions d'une collection respectueuse de l'environnement élaborée à partir de ressources renouvelables. Des matières premières sans danger pour la santé et des fibres bio-dégradables, tous ces éléments permettent la fabrication de produits durables.



Kollektion aus recycelten Materialien – in der ECO CARE Kollektion werden recycelte Rohstoffe wie Baumwolle, Plastik oder Glas zu neuen Produkten verarbeitet. Durch den geringeren Energieverbrauch bei der Produktion lassen sich erhebliche CO₂-Emissionen einsparen und wir tragen zum Klimaschutz bei. Durch das nachhaltige Recycling werden unsere wertvollen Ressourcen geschont und die Umwelt geschützt.

Collection from recycled materials – The Eco Care bath mat collection is made of 100% recycled cotton or PET bottles. Due to the low energy consumption during dismantling, processing and transport, considerable CO₂ emissions can be saved and Kleine Wolke thus contributes to climate protection. Through sustainable recycling, resources can be used, energy can be saved and the environment can be protected.

Collecte de matériaux recyclés – La collection de tapis de bain Eco Care est composée de bouteilles en coton ou en PET recyclées à 100%. Grâce à la faible consommation d'énergie lors du démantèlement, du traitement et du transport, il est possible d'économiser des émissions de CO₂ considérables et Kleine Wolke contribue ainsi à la protection du climat. Le recyclage durable permet d'utiliser les ressources, d'économiser l'énergie et de protéger l'environnement.



Geprüft und zertifiziert nach Öko-Tex Standard 100.
Frei von gesundheitlich bedenklichen Schadstoffmengen.

Quality mark for tested and certified textiles, free from quantities of toxic substances that are questionable with regard to health.

Label pour des textiles contrôlés et certifiés, exempts de quantités d'agents toxiques dangereux pour la santé.



Die Kleine Wolke Handtücher und viele Frotteivorleger sind mit dem V-Label gekennzeichnet. Das V-Label ist ein international anerkanntes, geschütztes Siegel für vegane und vegetarische Produkte.

Kleine Wolke towels and many terry mats are labelled with the V-label. The V-label is an internationally recognised, protected seal for vegan and vegetarian products.

Les serviettes de toilette Kleine Wolke et de nombreux tapis de bain portent le V-label. Le V-label est un label protégé et reconnu internationalement pour les produits végétaliens et végétariens.



Die **amfori BSCI** ist eine führende Unternehmensinitiative zur Verbesserung der Arbeitsbedingungen in globalen Lieferketten. Durch den Beitritt verpflichten sich die Teilnehmer, ihre Lieferanten in den amfori BSCI-Prozess einzubinden. Der amfori BSCI Code of Conduct legt die Werte und Prinzipien dar, deren Umsetzung in den Lieferketten die BSCI-Teilnehmer gemeinsam mit ihren Geschäftspartnern anstreben. Dadurch werden die sozialen und ökologischen Leistungen übergreifend verbessert.

Amfori BSCI is a leading corporate initiative that improves working conditions in global supply chains. Upon joining, participants commit to involving their suppliers in the amfori BSCI process. The amfori BSCI Code of Conduct defines the values and principles that BSCI participants and their business partners strive to implement in their supply chains. This helps to improve social and environmental performance across the board.

Amfori BSCI est une initiative d'entreprise de premier plan qui améliore les conditions de travail dans les chaînes d'approvisionnement mondiales. Lors de leur adhésion, les participants s'engagent à impliquer leurs fournisseurs dans le processus de l'amfori BSCI. Le code de conduite de l'amfori BSCI définit les valeurs et les principes que les participants à la BSCI et leurs partenaires commerciaux s'efforcent de mettre en œuvre dans leurs chaînes d'approvisionnement. Cela permet d'améliorer les performances sociales et environnementales de manière générale.

SERVICE VERTRIEB

Kleine Wolke

Textilgesellschaft mbH & Co. KG
Postfach 75 02 65
28722 Bremen / Germany
E-Mail: export@kleinewolke.com

SALES SERVICE

Haben Sie Fragen?
Wir helfen Ihnen gerne.

For further information do not
hesitate to contact us.

Avez-vous des questions?
N'hésitez pas de nous contacter.

Head of Export

Betrand Pichon
Tel. +49 421 6261-120
Fax +49 421 6261-230

Customer Service Export

Sabine Krannich
Tel. +49 421 6261-235
Fax +49 421 6261-230

Marc Lutz
Tel. +49 421 6261-233
Fax +49 421 6261-230

Schweiz

Kleine Wolke AG
Feldstraße 2
CH-5506 Mägenwil
E-Mail: info@kleinewolke.ch
www.kleinewolke.ch

Tel. +41 56 648 41 21
Fax +41 56 648 41 29

Österreich

Leifheit AG
Niederlassung Österreich
IZ NÖ-Süd, Strasse 16, Objekt 69/5/II
2355 Wiener Neudorf/Austria
E-Mail: info.austria@leifheit.com

Tel. +43 2236 64923
Fax +43 2236 64924



Kleine Wolke Textilgesellschaft mbH & Co. KG
Postfach 75 02 65
28722 Bremen · Germany
Tel.: 0421 6261-321
export@kleinewolke.com
www.kleinewolke.com



Klimaneutral
Druckprodukt
ClimatePartner.com/10886-2204-1015



4 004478 355163