



FUTUR vert





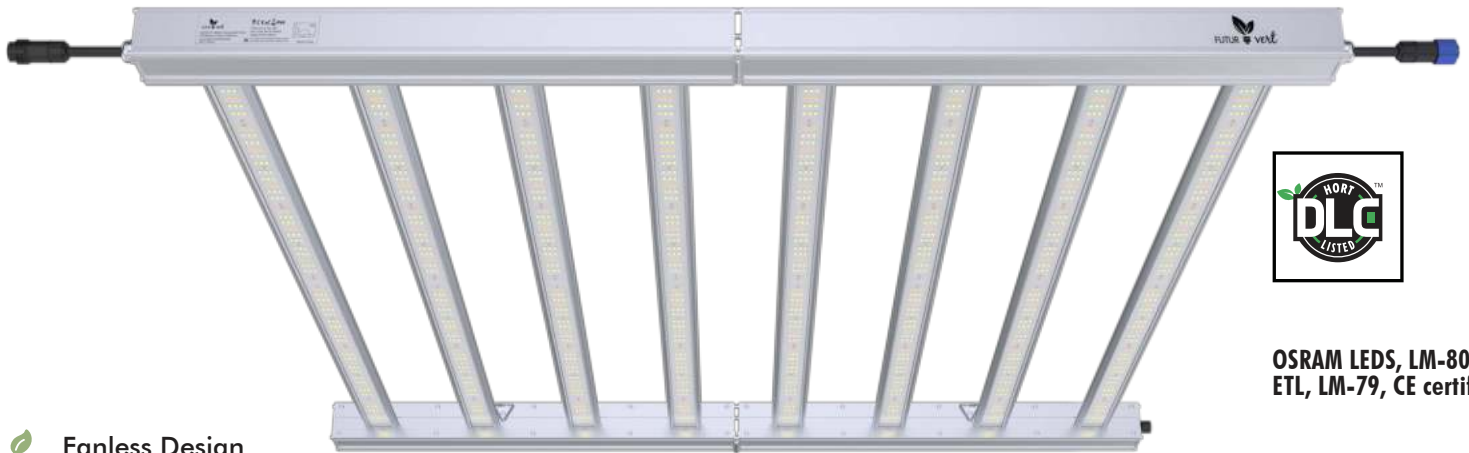

Designed for a controlled environment requiring a uniform and highly efficient photosynthetic flux density level, our superior green lighting solutions optimize the growth rate of your plants for the best performance in the industry.

Conçues pour un environnement contrôlé requérant un niveau de densité de flux photosynthétique uniforme et hautement efficace, nos solutions d'éclairage écologiques de qualité supérieure optimisent jusqu'à deux fois la vitesse de croissance de vos plants, pour le meilleur rendement de l'industrie.





OSRAM LEDs, LM-80
 ETL, LM-79, CE certification

-  Fanless Design
-  IP65 Waterproof
-  Dimmable: 0-10V/1-10V Dimming
-  Slim design, small, compact and easy to install with 180 degree foldable system.
-  Covering all growing stages including: Genetics, Propagation, Vegetation and Flowering
-  Quick connector for faster installation and with quick daisy chain connector, with simple power supply and dimming control function.
-  5 years warranty

 50/60Hz	 PF >0.9	 DIM 0-10V	 50000H	 Full Spectrum	 ETL Intertek	 CE	 IP65	 120-277V	 347-480V	 Spectrum Customize
--	---	---	--	---	--	---	--	--	--	--

SPECIFICATIONS

MODEL	FM3				FM4			
Power Consumption (incl. driver)	240W				320W			
Spectrum	FSM	FSG	FSMUV	R9B1	FSM	FSG	FSMUV	R9B1
PPF(μmol/s)	576	624	528	648	768	832	704	864
Efficacy (μmol/J)	2.4	2.6	2.2	2.7	2.4	2.6	2.2	2.7
Dimensions (L*W*H)	47*18*2.4inch (1193*458*62mm)				47*21.1*2.4inch (1193*458*62mm)			
Weight	11.9lbs (5.4kg)				14.6lbs (6.6kg)			

MODEL	FM6				FM8			
Power Consumption (incl. driver)	480W				660W			
Spectrum	FSM	FSG	FSMUV	R9B1	FSM	FSG	FSMUV	R9B1
PPF(μmol/s)	1152	1248	1056	1296	1452	1584	1452	1782
Efficacy (μmol/J)	2.4	2.6	2.2	2.7	2.4	2.6	2.2	2.7
Dimensions (L*W*H)	42*42.4*2.4inch (1067*1077*62mm)				42*42.4*2.4inch (1067*1077*62mm)			
Weight	24lbs (10.9kg)				30lbs (13.6kg)			

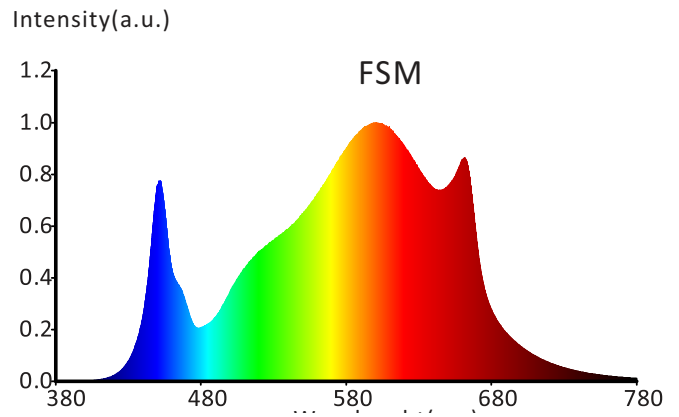
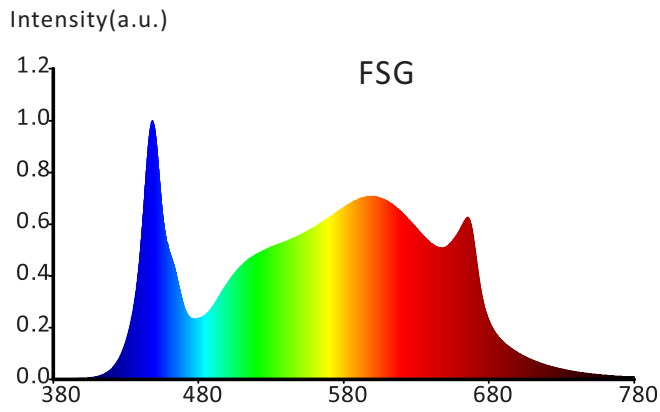

PHOTON FLUX DISTRIBUTION

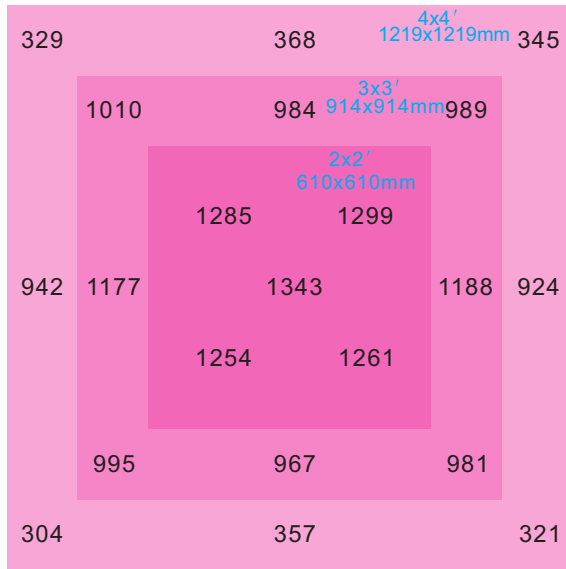

FM8 660W 2.4µmol/J 6''/152mm Height

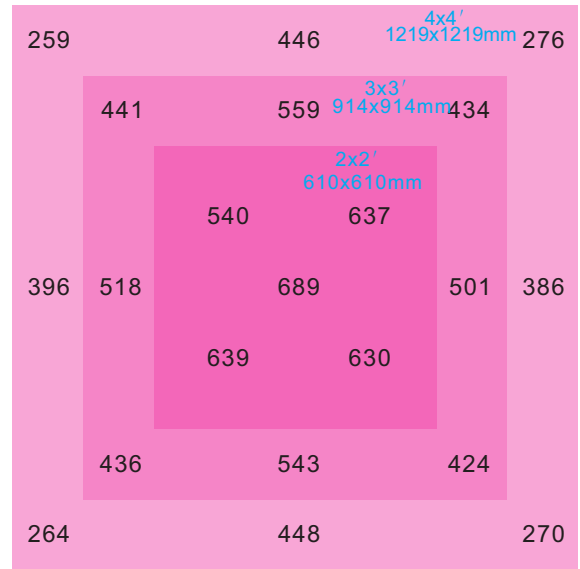

FM8 660W 2.4µmol/J 24''/609mm Height

DIMENSIONS

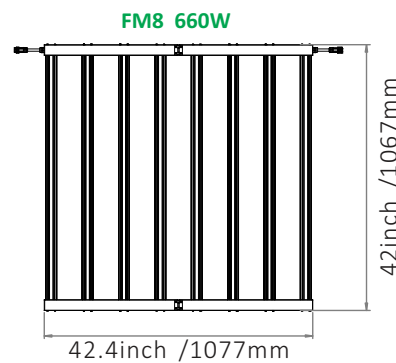
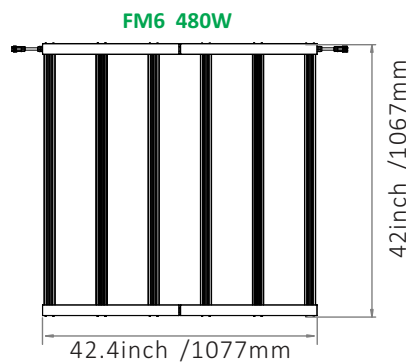
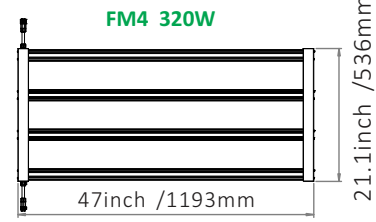
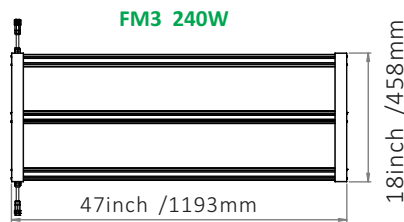

FloraKing series

- Fanless Design
- IP65 Waterproof
- Dimmable: 0-10V/1-10V Dimming
- Slim and light, easy to install
- Covering all growing stages including: Genetics, Propagation, Vegetation and Flowering
- Quick connect for a fast installation and daisy chain connection for interconnection
- 5 years warranty
- Linear design, perfect for Greenhouse installation



OSRAM LEDS, LM-80
 ETL, LM-79, CE certification

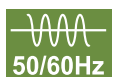

SPECIFICATIONS

MODEL	FKX10					FKX12					FKX15					
Power Consumption (incl. driver)	330W					530W					660W					
Input Voltage	AC100-277V / AC200-480V															
Input Current	Max 4A@100VAC Max 1.6A@230VAC Max 1.4A@277VAC					Max 4A@100VAC Max 1.6A@230VAC Max 1.4A@277VAC					Max 7.7A@100VAC Max 3.5A@230VAC Max 2.7A@277VAC					
Input Frequency	50/60Hz															
Power Factor	>0.9															
Spectrum	FSG			FSM		FSS			FSG			FSM		FSS		
PPF(μmol/s)	792	858	726	792	891	1272	1378	1166	1272	1431	1584	1716	1452	1584	1782	
Efficacy (μmol/J)	2.4	2.6	2.2	2.4	2.7	2.4	2.6	2.2	2.4	2.7	2.4	2.6	2.2	2.4	2.7	
Heat Output	1122 BTU/h					1802 BTU/h					2244 BTU/h					
Dimming	0-10V / 1-10V															
Operating Temperature	-4-113° (-20-45°)															
Storage Temperature	-40-176° (-40-80°)															
Dimensions (L*W*H)	39.4*5.1*7.9inch (1000*129*200mm)					44.9*5.1*7.9inch (1140*129*200mm)					59.1*5.1*7.9inch (1500*129*200mm)					
Weight	18.3lbs(8.3kg)					22.5lbs(10.2kg)					25.6lbs(12.5kg)					
L70 Rating	>78,000 hrs															
L90 Rating	>54,000 hrs															
ETL Certification	DLC / ETL / UL 8800 / CE															
Location Rating	Damp															
LVD Certification	IEC/EN 60598-2-1 IEC/EN 60598-1															

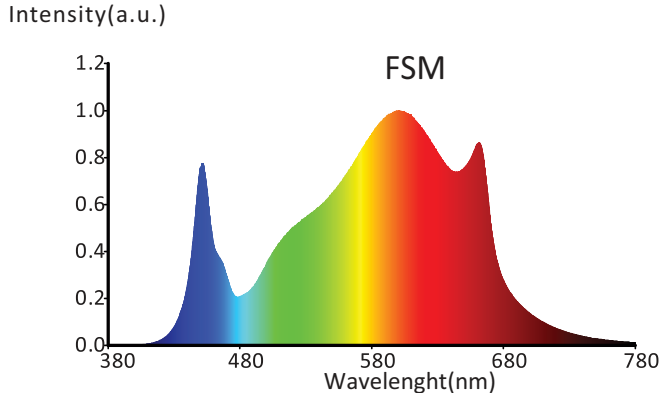
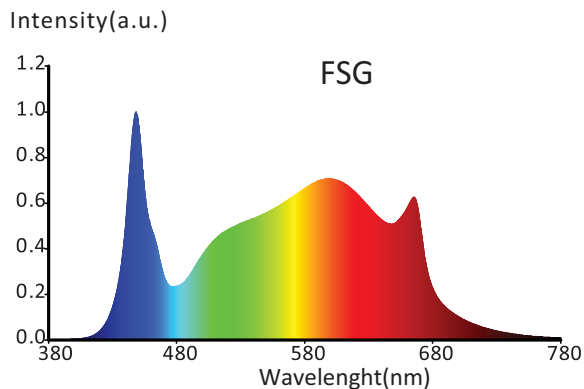

PHOTON FLUX DISTRIBUTION

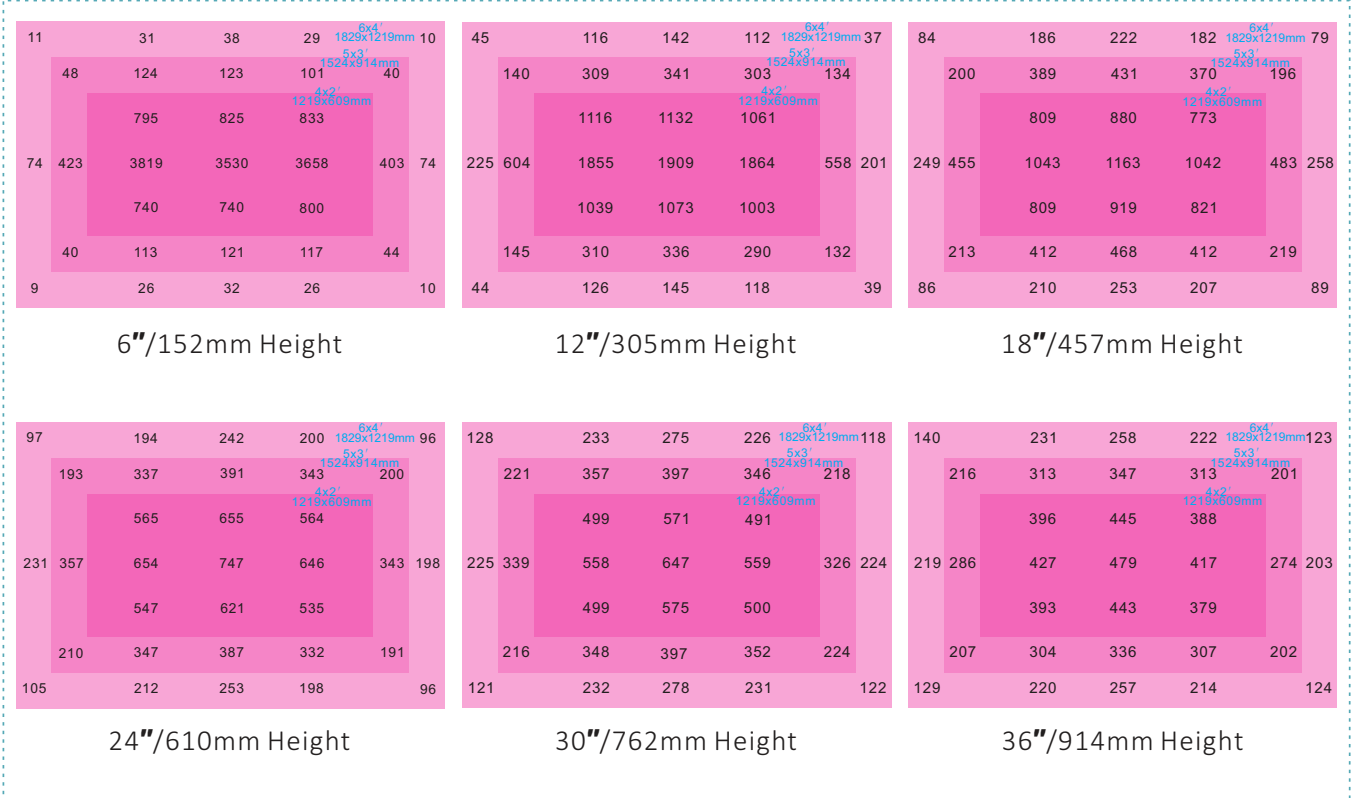

DIMENSIONS

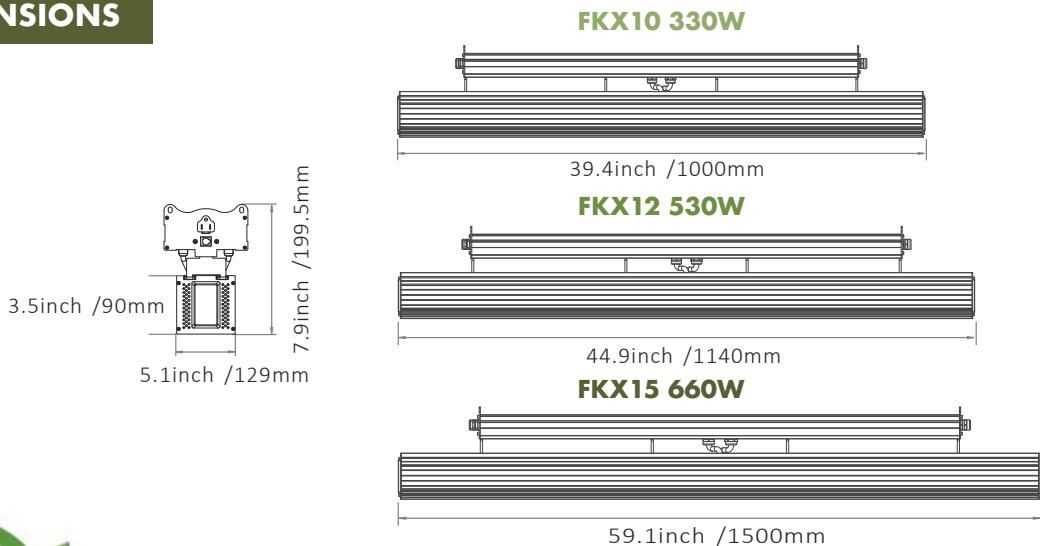



- Fanless Design
- IP65 Waterproof
- Slim design with integrated driver, compact and easy to install.
- Covering all growing stages including: Propagation, Vegetation and Flowering
- Quick connect for ease connection in series.
- 5 years warranty.



OSRAM LEDs, LM-80
 ETL, LM-79, CE certification

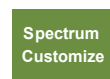

SPECIFICATIONS

MODEL	FN06						FN12						FN16					
Power Consumption (incl. driver)	50W						85W						130W					
Input Voltage	AC100-277V																	
Input Current	Max 0.6A@100VAC Max 0.3A@230VAC Max 0.25A@277VAC						Max 1A@100VAC Max 0.5A@230VAC Max 0.4A@277VAC						Max 1.5A@100VAC Max 0.7A@230VAC Max 0.55A@277VAC					
Input Frequency	50/60Hz																	
Power Factor	>0.9																	
Spectrum	FSG		FSM		R9B1		FSG		FSM		R9B1		FSG		FSM		FSS	
PPF(μmol/s)	115	125	105	115	106	135	196	213	179	196	179	230	299	325	273	299	273	351
Efficacy (μmol/J)	2.3	2.5	2.1	2.3	2.1	2.7	2.3	2.5	2.1	2.3	2.1	2.7	2.3	2.5	2.1	2.3	2.1	2.7
Heat Output	170 BTU/h						289 BTU/h						442 BTU/h					
Dimming	Non-dimmable																	
Operating Temperature	-4F - 113F° (-20C - 45C°)																	
Storage Temperature	-40F - 176F° (-40C - 80C°)																	
Dimensions (L*W*H)	23.8*2.1*1.3inch (604*54*33mm)						47.2*2.1*1.3inch (1200*54*33mm)						63*2.1*1.3inch (1600*54*33mm)					
Weight	1.54lbs(0.7kg)						1.98lbs(0.9kg)						2.64lbs(1.2kg)					
L70 Rating	>78,000 hrs																	
L90 Rating	>54,000 hrs																	
ETL Certification	UL 8750 Luminaires (UL 1598:2008 Ed.3 +R:17Oct2012) Luminaires (R2013) (CSA C22.2#250.0:2008 Ed.3 +G1;G2)																	
Location Rating	Damp																	
LVD Certification	IEC/EN 60598-2-1 IEC/EN 60598-1																	

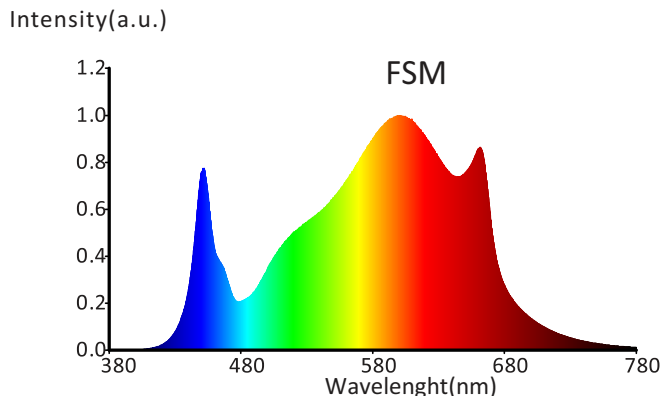
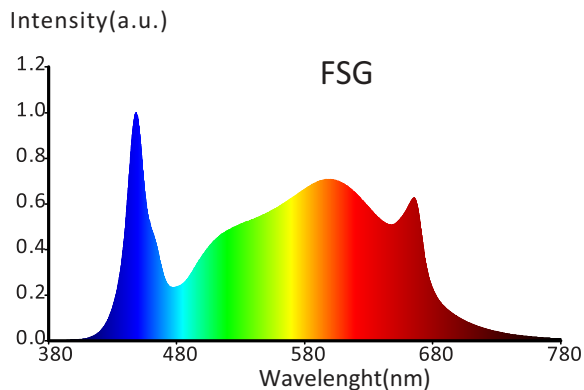

PHOTON FLUX DISTRIBUTION

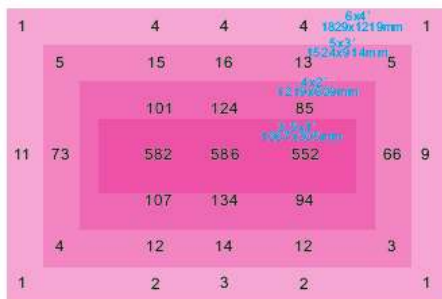

6"/152mm Height

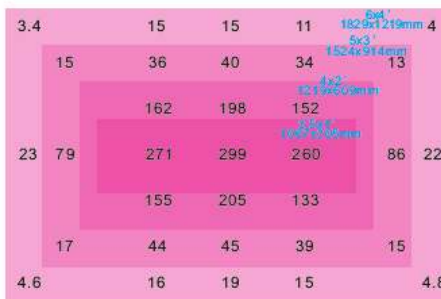

12"/305mm Height

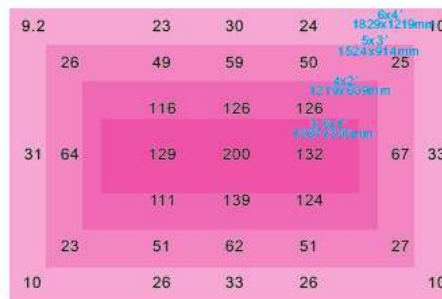

18"/457mm Height

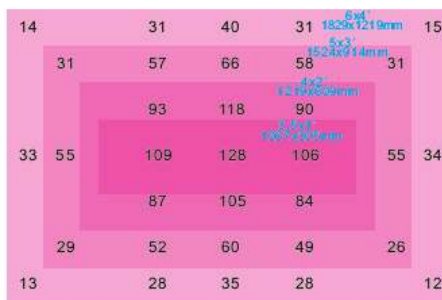

24"/610mm Height

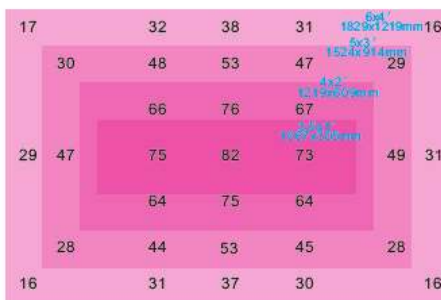

30"/762mm Height

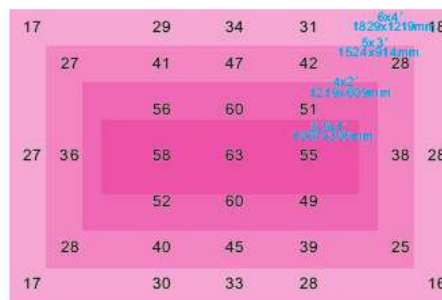

36"/914mm Height

DIMENSIONS

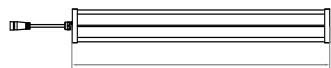

23.8inch /
604mm

FN06
50W

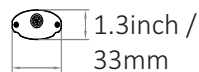

2.1inch /

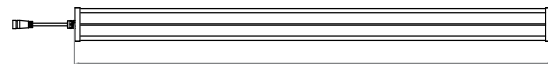

47.2inch /
1200mm

54mm **FN12**

85W









63inch /
1600mm

LM16
130W

FloraLeafMax series



OSRAM LEADS, LM-80
 ETL, LM-79, CE certification

-  Fanless Design
-  IP65 Waterproof
-  Dimmable: 0-10V/1-10V Dimming
-  Slim design with integrated driver, making it small, compact and easy to install.
-  Full spectrum for all growing stages including: Clones, Propagation, Vegetation and Flowering
-  Quick connect for ease connection. Surfaced mounted or pendant installation for different growing environment.
-  5 years warranty

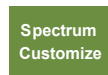
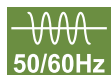

SPECIFICATIONS

MODEL	FLM10						FLM12					
Power Consumption (incl. driver)	40W						60W					
Input Voltage	AC100-277V											
Input Current	Max 0.5A@100VAC Max 0.25A@230VAC Max 0.2A@277VAC						Max 0.7A@100VAC Max 0.35A@230VAC Max 0.3A@277VAC					
Input Frequency	50/60Hz											
Power Factor	>0.9											
Spectrum	FSM		FSG		R9B1		FSM		FSG		R9B1	
PPF(μmol/s)	84	92	92	100	84	108	126	138	126	150	126	162
Efficacy (μmol/J)	2.1	2.3	2.3	2.5	2.1	2.7	2.1	2.3	2.3	2.5	2.1	2.7
Heat Output	136 BTU/h						204 BTU/h					
Dimming	0-10V / 1-10V											
Operating Temperature	-4-113° (-20-45°)											
Storage Temperature	-40-176° (-40-80°)											
Dimensions (L*W*H)	47.2*5.1*1.5inch (1199*130*38mm)											
Weight	1.98lbs(0.9kg)						2.2lbs(1kg)					
L70 Rating	>60,000 hrs											
L90 Rating	>42,000 hrs											
ETL Certification	UL 8750 Luminaires (UL 1598-2008 Ed.3+R:17Oct2012) Luminaires (UL 1598-2008 Ed.3+R:17Oct2012)											
Location Rating	Damp											
LVD Certification	IEC/EN 60598-2-1 IEC/EN 60598-1											

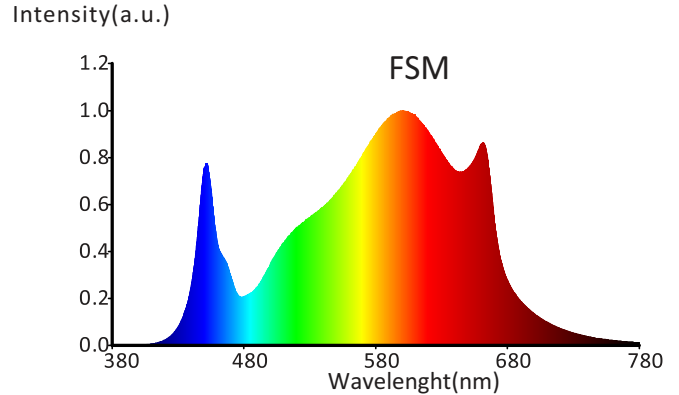
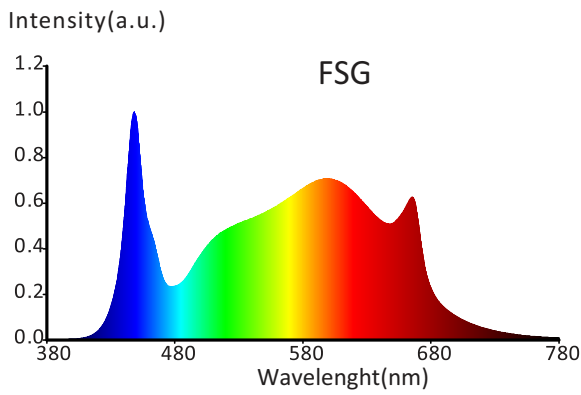

PHOTON FLUX DISTRIBUTION

60W FLM12 PPFD Distribution FSG 2.3umol/s

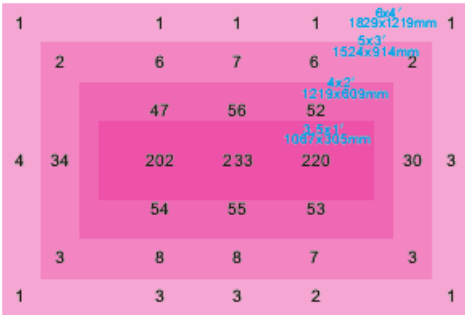

6"/152mm Height

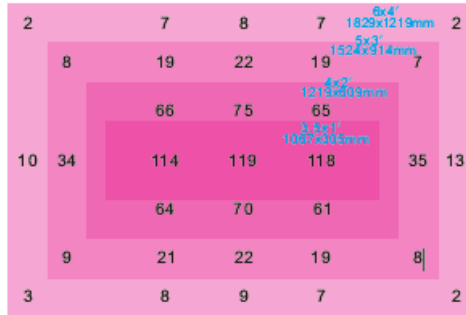

12"/305mm Height

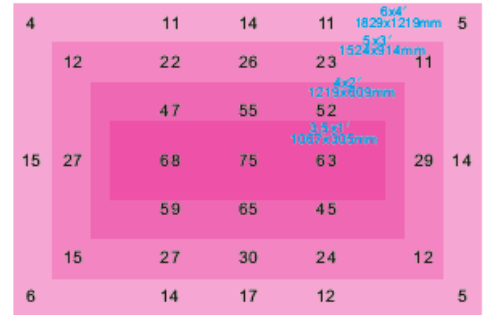

18"/457mm Height

40W FLM10 PPFD Distribution FSG 2.3umol/s

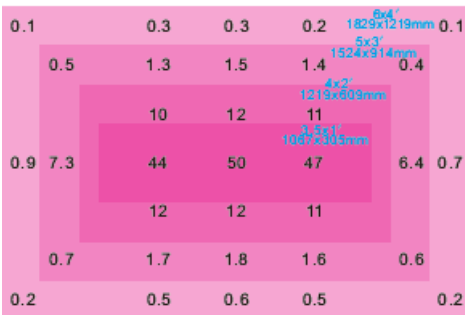

6"/152mm Height

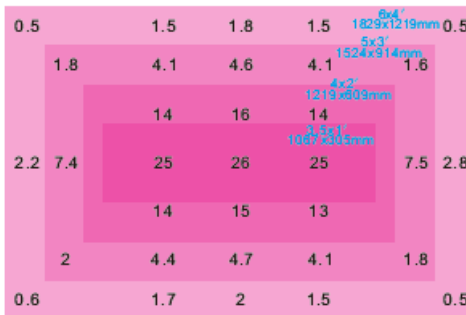

12"/305mm Height

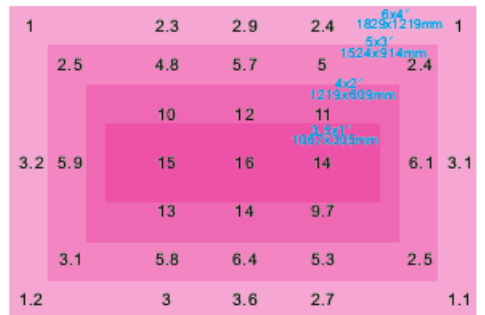

18"/457mm Height

DIMENSIONS

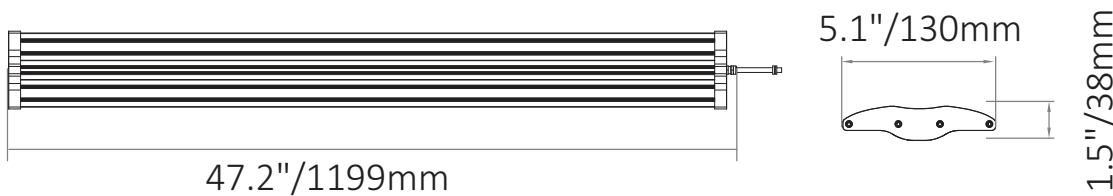

VERTICAL FARMING

6pcs FLM 40W LED Grow Light could replace T5 4ft 8 pcs *54W Fluorescent Tube light. Futur Vert LED Grow Light is 35% higher in PPFD, 35% lower in power consumption and 50% less in BTU. FLM series are not only suitable for genetic & propagation period of marijuana but also suitable for lettuce & leaf planting.









456 boul. des Laurentides, Piedmont (Québec) Canada J0R 1K0
 514 627-4489 sales@faturvert.com



Horti-GREEN Indoor Farming



- Aluminium Housing material 
- Anodized/Antifouling power coating 
- Glue coating (transmission >97%) optics materials 
- 120° of radiation angle 
- IP65 Protection degree 
- Suspended or surface mounted installation 
- 5 years warranty 



DLC ETL certification
 Low voltage Directive (LVD)
 Electromagnetic Compatibility Directive (EMC)
 Restriction of Hazardous Substances (RoHS) Directive

SPECIFICATIONS

MODEL	FUHG 12		FUHG 24	
Power Consumption (incl. driver)	20W / 30W		40W / 60W (±5%)	
Power Factor	>0.9			
Voltage range	100-277 VAC		100-277 VAC	
Current Range	0.18A-0.065A	0.3A-0.11A	0.4A-0.15A	0.6A - 0.22A
Frequency Range	50/60Hz			
Waterproof	IP65			
Isolation Class	Class I			
Operating Temperature	32°F - 104°F (0°C - 40°C) 95% RH			
Storage Temperature	-4°F - 149°F (-20°C - 65°C) 85% RH			
PPF(μmol/s)	54	81	105	160
Efficacy (μmol/J)	1.9 - 2.2			
Dimensions (L*W*H)	47.25*1.88*1.28inch (1200*47.9*32.6mm)		94.50*1.88*1.28inch (2400*47.9*32.6mm)	

APPLICATION: HORTI-GREEN INDOOR VERTICAL GROWTH SHELF SOLUTION

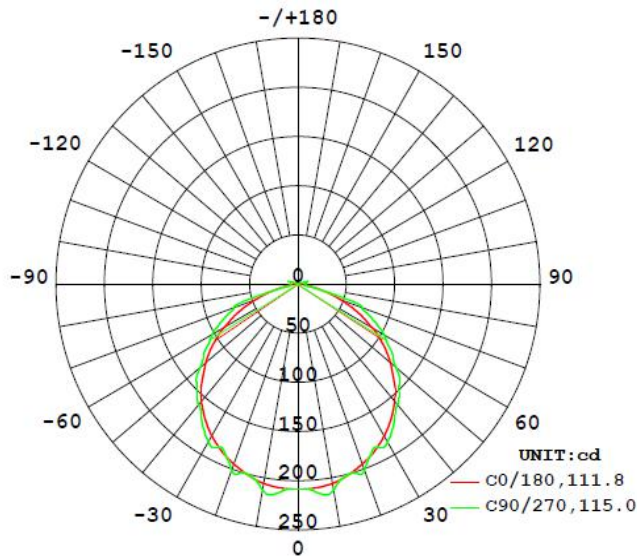
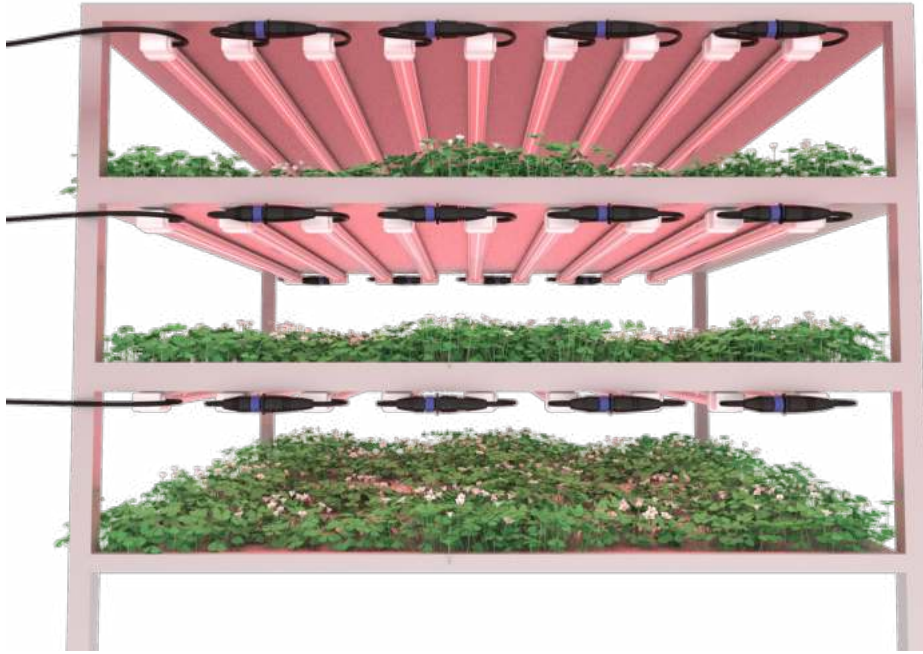

DIMENSIONS

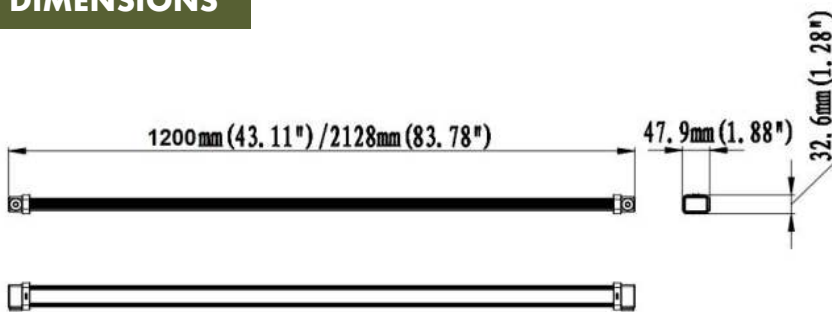

- 18 pcs per carton
- Gross weight per carton
- 47.2*10.2*9.3 inch (1350*260*235mm)

Horti-Bar LED Grow Light

OSRAM LEDs, LM-80
 ETL, LM-79, CE certification



- 🌱 Specially design for indoor vertical farming
- 🌱 Flexible module design with IP65 Rating
- 🌱 High power to get higher PPFd output
- 🌱 External driver, easy of maintenance and customized power is available
- 🌱 Ideal for indoor & vertical Shelf growing cucumber, leaf greens, fruits and many other plants
- 🌱 3 years warranty (optionnal 5 years)

 50/60Hz	 PF >0.9	 DIM 0-10V	 50000H	 Full Spectrum	 ETL Intertek	 CE	 Ip65	 120-277V	 Spectrum Customize
--	---	---	--	---	--	---	--	--	--

SPECIFICATIONS

MODEL	FV05-40	FV05-90
Power Consumption (incl. driver)	40W	90W
Input Voltage	AC120V-277V - Optional 347V-480V	
Input Frequency (Constant Current) CC	50/60Hz	
Power Factor	≥ 0.93	
Surge protection	Yes	
Spectrum	Customized Spectrum Available	
PPF(μmol/s)	72	213
Efficacy (μmol/J)	1.8	
Heat Output	170 BTU/h	289 BTU/h
Dimming	Available (+Intelligent Control optional)	
Operating Temperature	-22°F - 95°F (-30°C to +35°C)	
Life Time	>50000Hrs (Ta=30°C@L70)	
Dimensions (L*W*H)	289*1111*123mm	
Luminaire Net Weight	1±0.3kg	
Gross Weight	1.5±0.3kg	
Material	Housing	Pure Aluminium
	Optics	PC Cover or silicone glue
Fixture Color	Silver	
IP Rating	IP65	
Mounting Option	Clip	
Accessory	PC Cover	
	Bracket	
	Connector	
	Plug- EU/US/AU Standard Plug if needed	

CUSTOMIZED SPECTRUM AVAILABLE

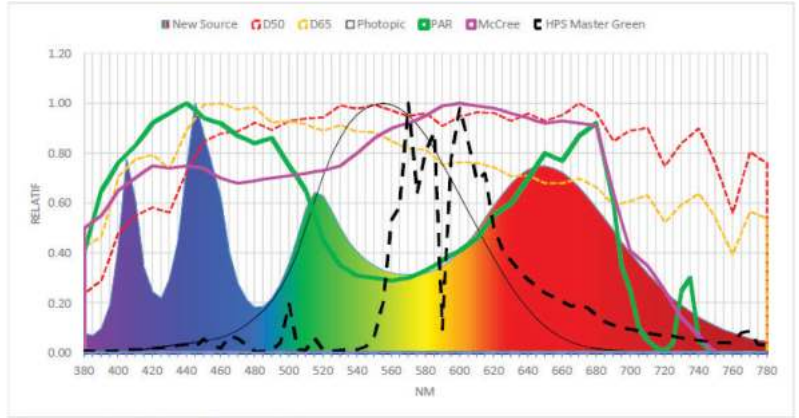
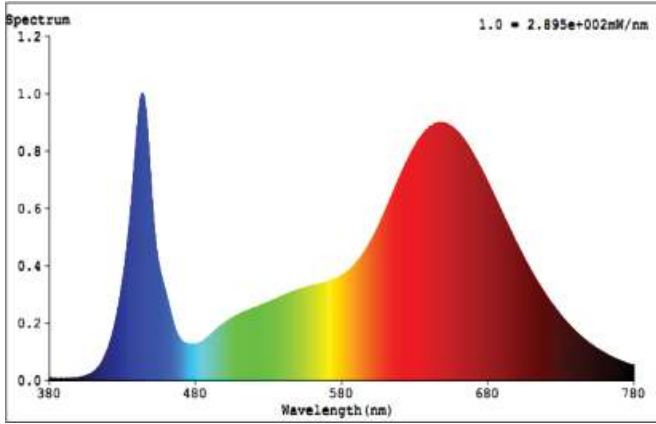

ACCESSORIES (3T CONNECTOR)

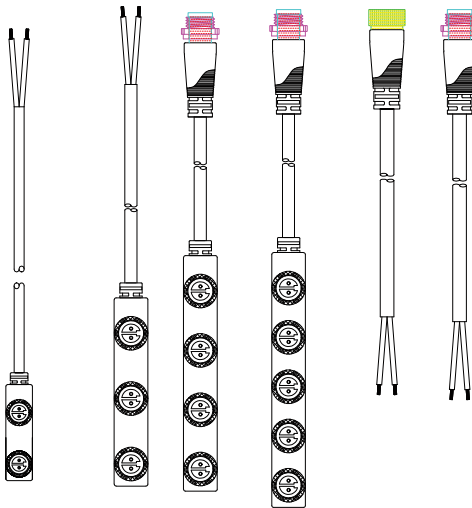

PHOTOMETRY

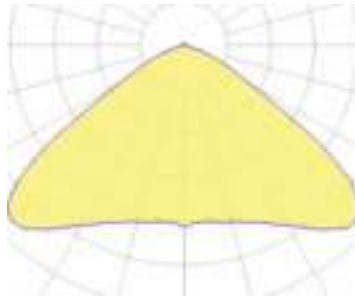

120° PC Cover
(L06403)



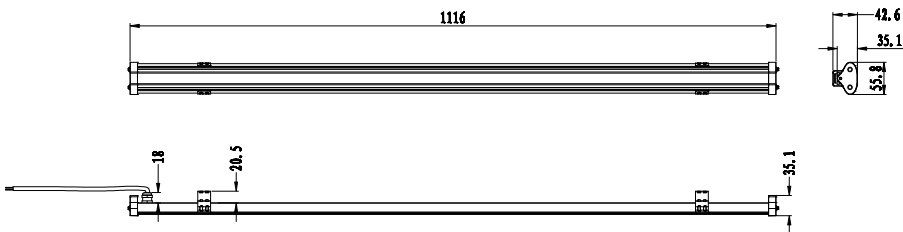



DIMENSIONS



Horti-UV Plus

Indoor Farming



- Aluminium Housing material 
- Anodized/Electrophoresis + Powder coating 
- Ultra Clear glass optics materials 
- 120° of radiation angle 
- IP65 Protection degree 
- Suspended or surface mounted installation 
- 5 years warranty 

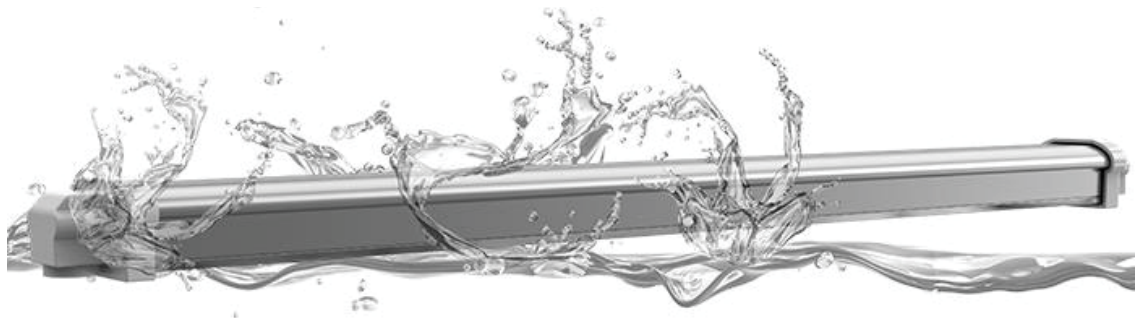

Federal Communications Commission





IP65 waterproof design

CE RoHS



CAUTION
 Ultraviolet(UV) Radiation
 Do not look directly into the UV light during operation.
 Wear protective eyewear to avoid exposure to UV light.
 Avoid direct eye and skin exposure to UV light.
 Keep out of reach of children

ETL
 Low voltage Directive (LVD)
 Electromagnetic Compatibility Directive (EMC)
 Restriction of Hazardous Substances (RoHS) Directive

SPECIFICATIONS

MODEL	UVA SUPPLEMENTAL LIGHTING SOLUTION	
Power Consumption (incl. driver)	30W(±5%)	
Power Factor	>0.9	
Voltage range	110-277 VAC	
Current Range	0.3A-0.11A	
Frequency Range	50/60Hz	
Inrush current	< max. 25A (t<1 msec)	
Isolation Class	Class I	
Operating Temperature	32°F - 104°F (0°C - 40°C) 95% RH	
Storage Temperature	-4°F - 149°F (-20°C - 65°C) 85% RH	
Wavelength	385 nm	
Water resistance rating	ip65	
Dimensions (L*W*H)	23.6*2.24*1.53inch (600*57*39mm)	44.88*2.24*1.53inch (1140*57*39mm)
Net weight	1 kg/2.2 lbs	

APPLICATION



Spectrum chart

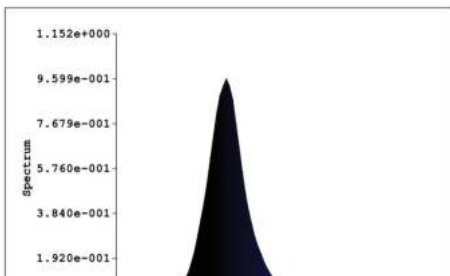

CAUTION
 Ultraviolet(UV) Radiation
 Do not look directly into the UV light during operation.
 Wear protective eyewear to avoid exposure to UV light.
 Avoid direct eye and skin exposure to UV light.
 Keep out of reach of children

UV Radiation

*Regular Efficiency

Euva	12129 mW
Euvb	0 mW
Euvc	0 mW
Euv	12129 mW
E(vis)	10720 mW

UV-A irradiance
UV-B irradiance
UV-C irradiance
Irradiance for wavelength from 250nm to 400nm
Irradiance for wavelength from 380nm to 780nm

*Higher Efficiency

Euva	14458 mW
Euvb	0 mW
Euvc	0 mW
Euv	14458 mW
E(vis)	12307 mW

UV-A irradiance
UV-B irradiance
UV-C irradiance
Irradiance for wavelength from 250nm to 400nm
Irradiance for wavelength from 380nm to 780nm

DIMENSIONS

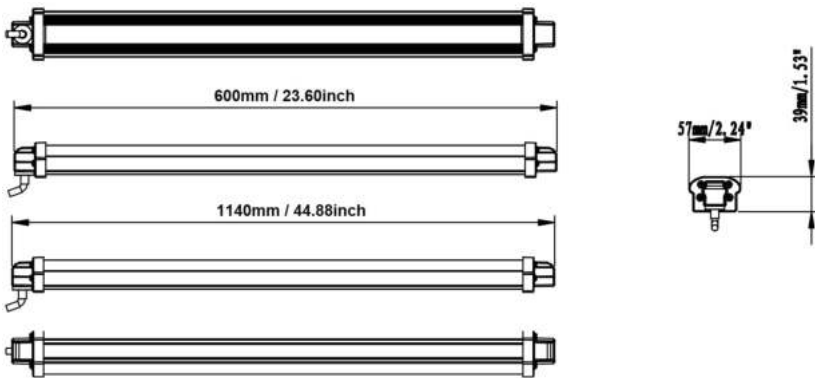

- 8 pcs per carton**
- Gross weight per carton**
12kg/26.24 lbs
- Inner carton packing size**
24.4* 3.15*3,15 inch (620*80*80mm)
- Outer carton packing size**
25.92*13.58*7.28 inch (635*345*185mm)