

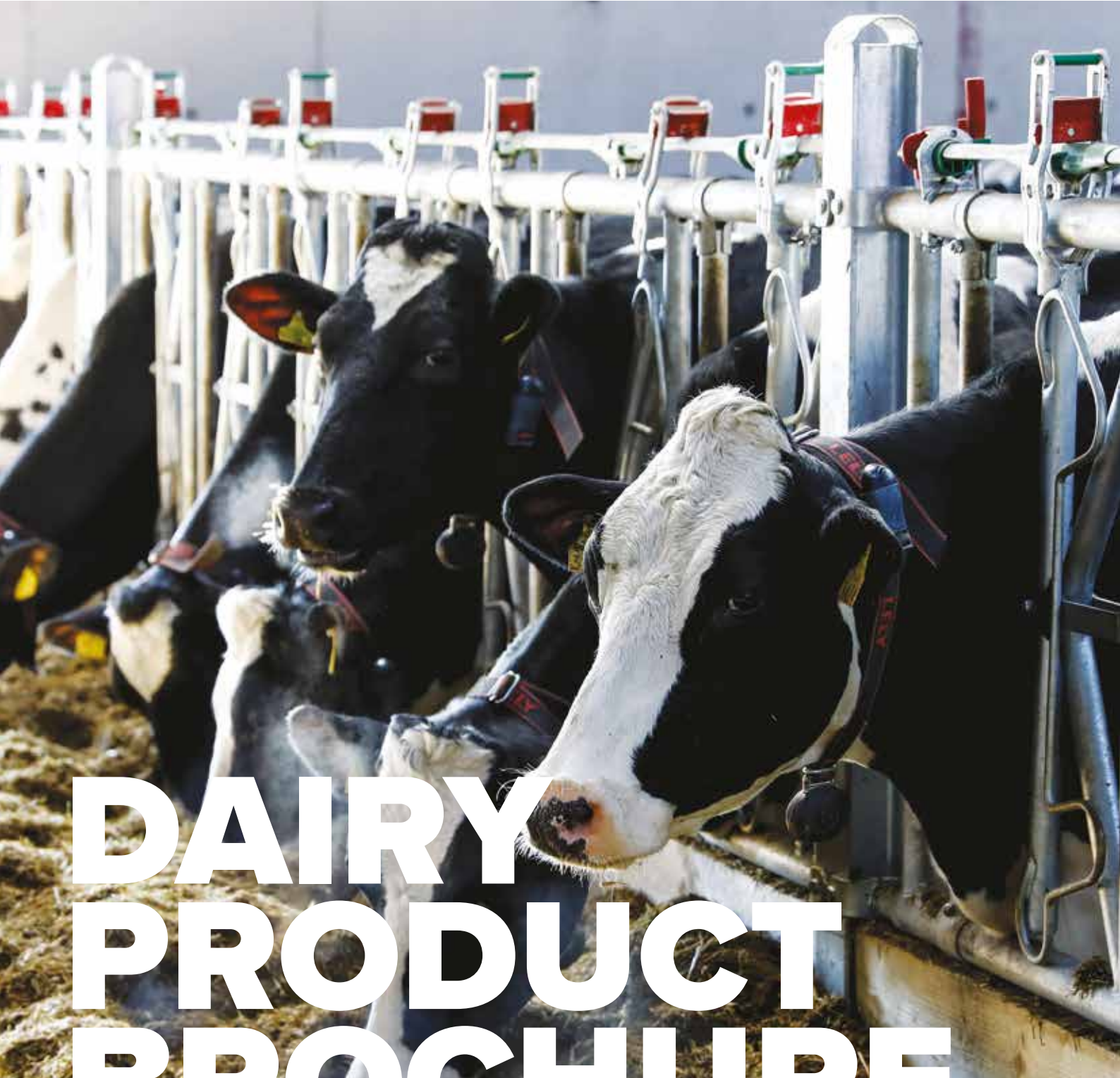

**TEEMORE
ENGINEERING**
LIVESTOCK HOUSING SPECIALISTS



DAIRY PRODUCT BROCHURE

2023-2024



**TEEMORE
ENGINEERING**
LIVESTOCK HOUSING SPECIALISTS

Teemore Engineering has been at the heart of innovation within the agricultural engineering sector for almost 50 years. During this time the products sourced, designed and produced have evolved to meet the requirements of modern dairy and beef farmers.

All manufactured goods are produced at Teemore's head office site based outside the village of Derrylin in Fermanagh where large stocks of finished products are stored ready for distribution. In more recent years a new storage depot was opened at Whitchurch in Shropshire in the heart of England where again goods are stock piled ready for distribution.

Teemore are a market leader in the design and production of cow cubicles. Our focus has revolved around the comfort of the cow and engineered to stand the test of time.

TEEMORE ENGINEERING QR CODES

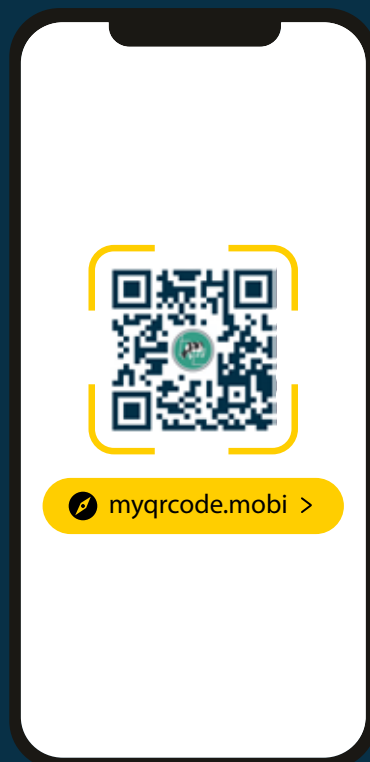

1

OPEN YOUR
PHONE CAMERA

2

FOCUS ON THE
PRODUCT QR CODE

3

TAP THE POP-UP
TO OPEN THE
PRODUCT PAGE



**TEEMORE
ENGINEERING**
LIVESTOCK HOUSING SPECIALISTS

DAIRY PRODUCT BROCHURE

GATES & BARRIERS	4
CUBICLES.....	20
MATS & MATTRESSES.....	28
RUBBER FLOORING.....	36
DRINKERS.....	44
CRUSHES & HANDLING	50
FEEDERS.....	56
VENTILATION.....	58
PRODUCT INDEX.....	62

DAIRY PRODUCT BROCHURE

GATES & BARRIERS

WE OFFER BOTH BESPOKE AND OFF THE SHELF GATING SOLUTIONS TO MEET ALL YOUR PENNING AND HANDLING NEEDS, WITH THE SAFETY OF BOTH LIVESTOCK AND HANDLERS A PRIORITY.

HEADLOCKS

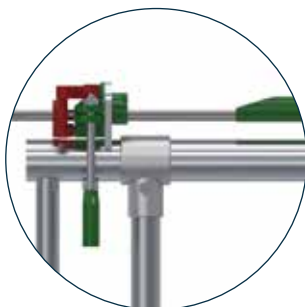

*handle has two positions;
lock and feed*



*patented locking
mechanism*

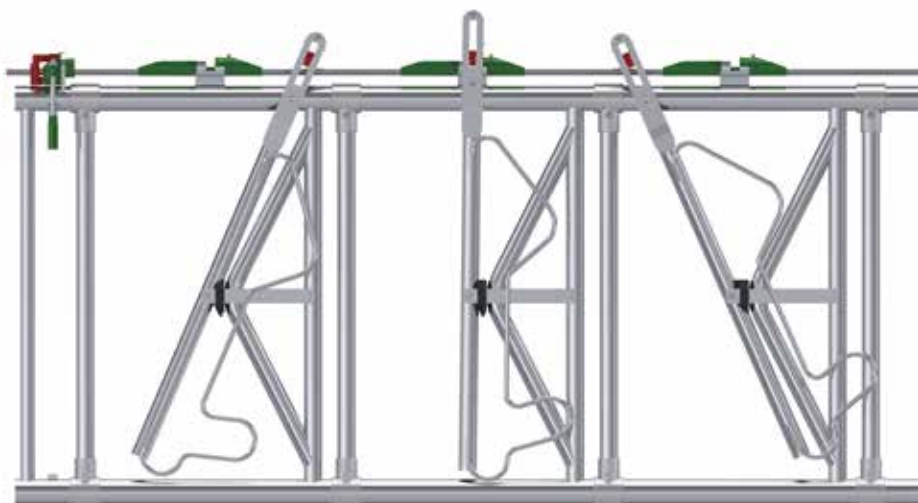

Jourdain Safety IV Headlocks



Designed and manufactured to suit a wide range of ages and breeds of livestock maximising the safety and comfort for both the farmer and the animal. Unbeatable quality and durability these sturdy headlocks are built to last.

- Link up to 6 panels together
- Heifer/calf guards to close small dangerous spaces
- Anti-choke system to release a fallen animal
- Adjustable end pieces for ease of installation
- Pendulum bar is bushed at pivot point for increased longevity
- Adjustable collar width
- Hot dipped galvanised (ISO 9002 Certified)
- Release animals one by one or release all together



HEADLOCKS

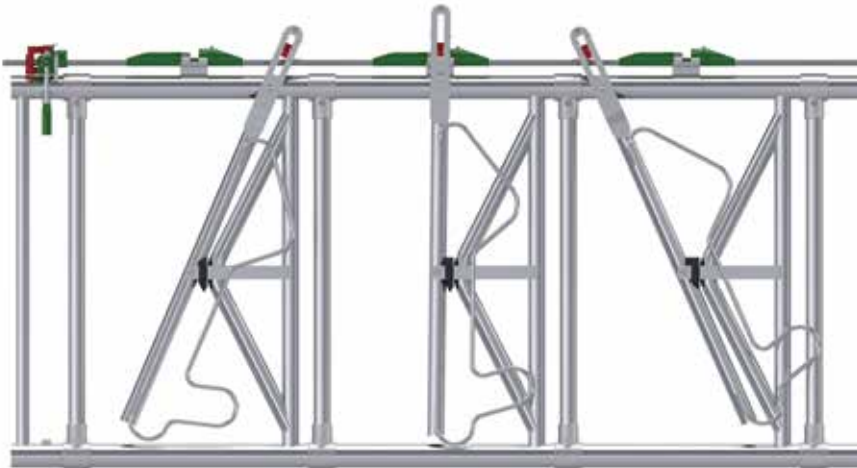

Heifer Headlocks

Heifer version of the safety IV headlock is designed with additional spaces to suit dairy heifers. Manufactured to the same strength and quality as the original safety IV headlock, however with smaller head spaces.

BARRIER

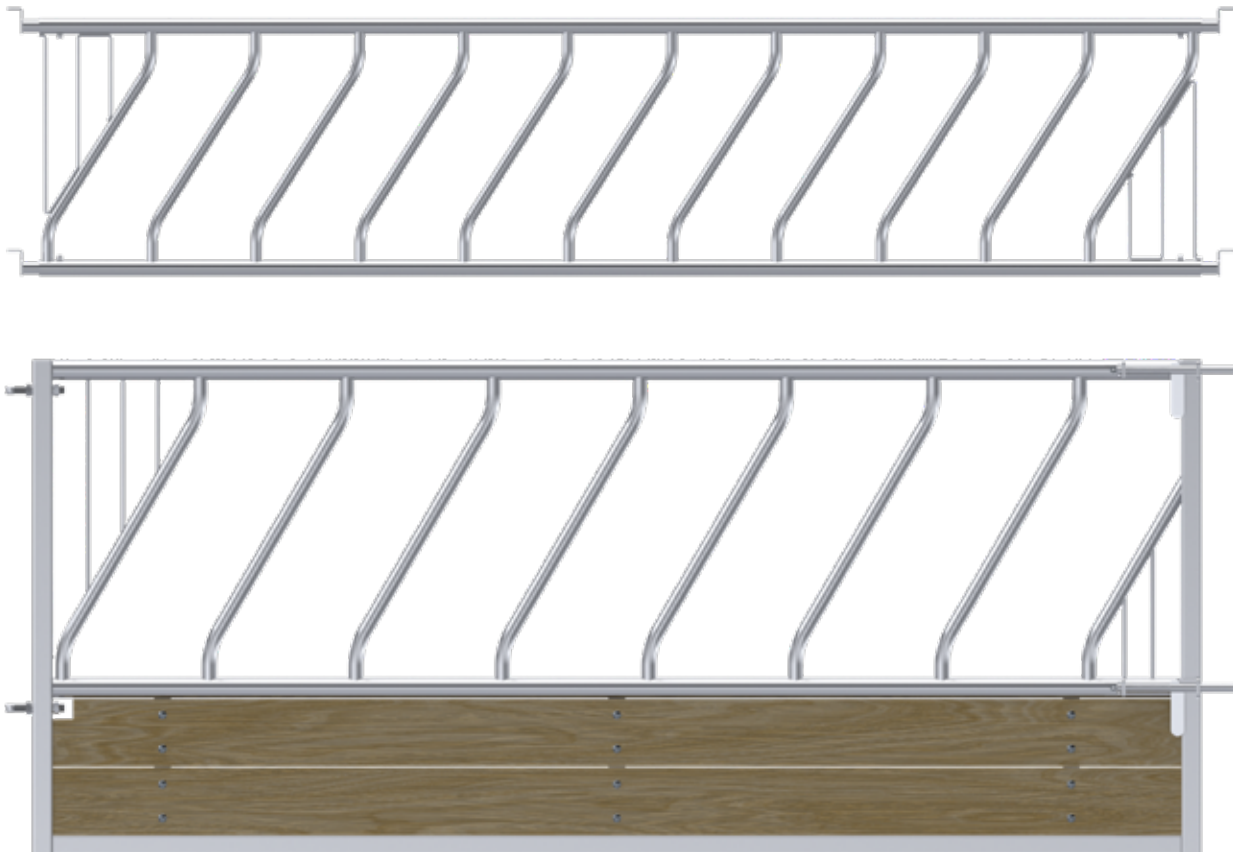

60mm & 76mm Diagonal Feed Barrier



Diagonal barrier designed to maximise feeding spaces while reducing feed wastage. All standard sizes are kept in stock. Cost effective feed barrier option and suitable for various animal sizes making it a very popular choice by farmers.

Timber Diagonal Gate



Diagonal barrier complete with timber base is designed to swing open as a complete gate. Ideal for feed passages where access to penning is required on a regular basis. Standard sizes available in stock with bespoke sizes available on request.

HEADLOCKS



Bull Headlock

Reinforced headlock specifically designed for bulls. A must have for any bull pen creating a safe working environment when cleaning or bedding.



CUSTOMER TESTIMONIAL



“When looking at the various solutions for head locking available on the market, it was apparent that the Safety IV headlocks supplied by Teemore, can’t be beat. We have had them for seven years and use them every day for AI, Vaccines and other medical procedures and one of the main features you notice is how quiet they are compared to others.”

David Craven
Grosvenor farms

BARRIER



Single Pipe Neck Rail & Spacer Bracket

Heavy duty single pipe feeding system. This cost-effective feeding option is commonly used in dairy cow housing. The 100mm space bracket is designed to push the rail away from the cow, reducing contact and allowing further reach.

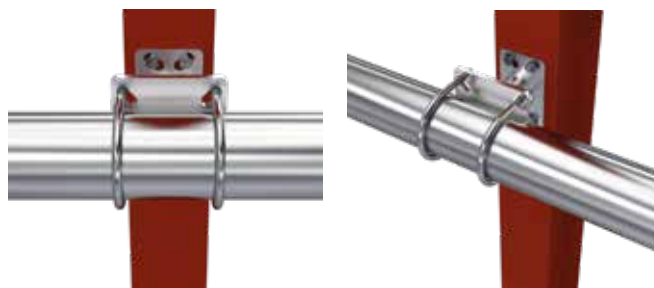

GATE

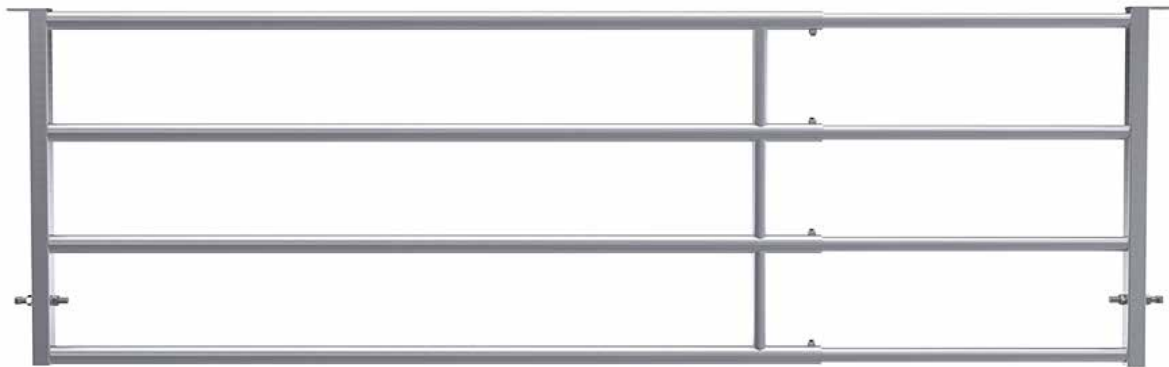

4 bar standard back



4 bar drinker back

*Each gate comes in two parts – the Gate Back and the Gate End

4 Bar Standard Back

4 tubes made from tube \varnothing 60mm, length 2.5m.
Compatible with all 4 Bar Ends.



4 Bar Drinker Back

4 tubes made from tube \varnothing 60mm, length 2.5m.
Compatible with all 4 Bar Ends.



GATE



4 Bar Spring Gate

Heavy duty 4 bar spring latch gate end is designed with 1 or 2 metres of telescopic adjustment within each size. 2 metre extension available by using long panel end.



GATE



Surlock 101 Brackets

Range of Surlock brackets for use with spring latch receivers.

GATE

**4 Bar Panel Gate**

Heavy duty 4 bar panel end designed with 1 or 2 metres of telescopic adjustment within each size. Ideal for dividing pens. 2 metre extension available by using long panel end.

GATE

**4 Bar Square Gate**

Heavy duty 4 bar centre latch square gate end is designed with 1 or 2 metres of telescopic adjustment within each size. 2 metre extension available by using long panel end.

GATE

**4 Bar Drinker Bowl Gate**

Heavy duty 4 bar drinker bowl panel area designed with 1 metre of telescopic adjustment within each size. 2 metre extension available by using long panel end.

GATE

**4 Bar Drinker Trough Gate**

Heavy duty 4 bar trough panel is designed with 1 metre of telescopic adjustment within each size. 2 metre extension available by using long panel end.

GATE

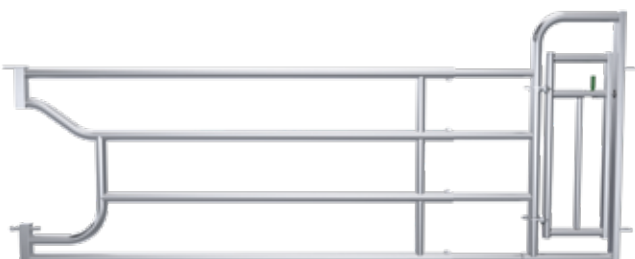
**4 Bar Man Escape Gate**

Heavy duty 4 bar man escape panel is designed with 1 metre of telescopic adjustment within each size. 2 metre extension available by using long panel end.

GATE

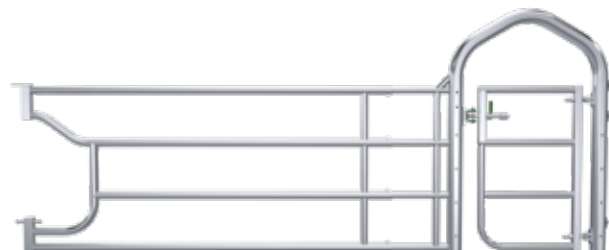
**4 Bar Access Arch Gate**

Heavy duty 4 bar access arch panel is designed with 1 metre of telescopic adjustment within each size. Access gate available as separate piece

GATE

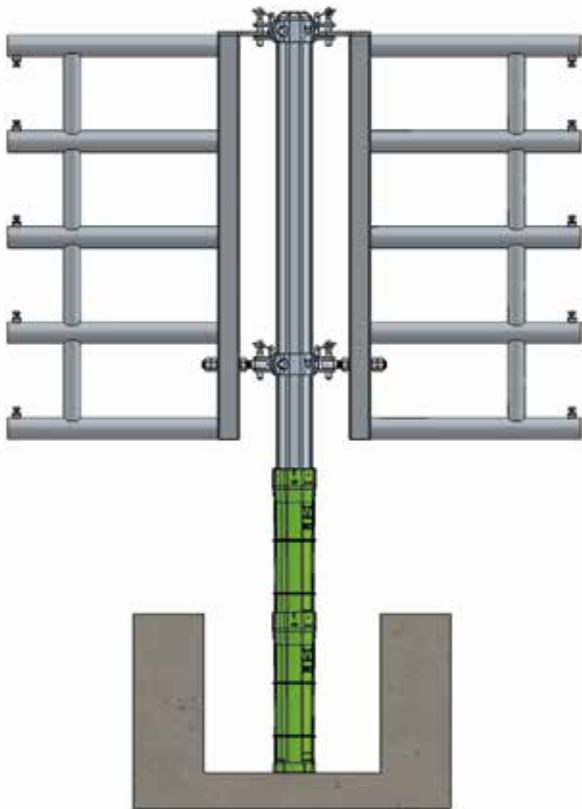

4 direction strap hanger

Strap Hangers

Range of strap hangers for use with Jourdain 101mm and 140mm octagonal posts.



Octagonal Posts & Clamps

Jourdain 101mm and 140mm stock friendly octagonal posts. The patented 8-sided shape eliminates the chance of rotating when either set in a socket or concrete.

GATE

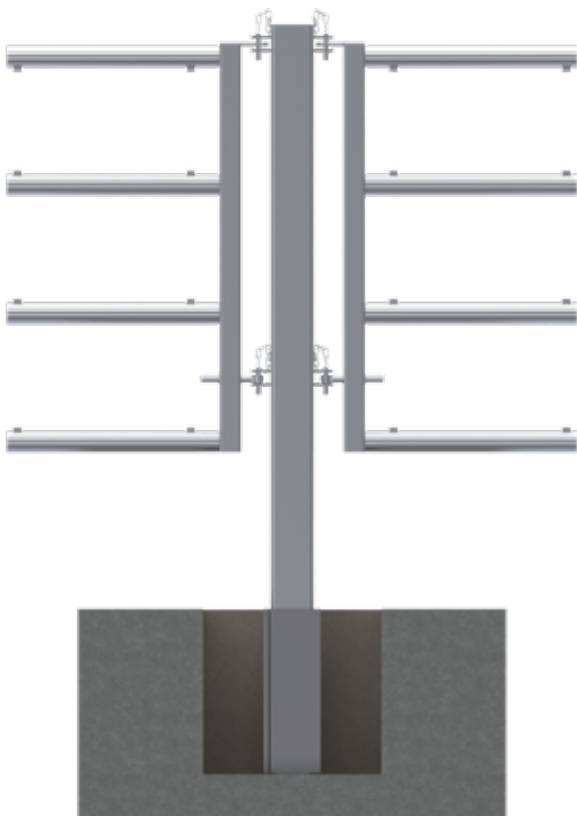

4 direction post hanger

Hangers

Range of hangers for use with 120mm box posts.



120mm Box Posts

The box post is ideal for any penning situation, especially in areas where gates are opened continuously. This is because the box post is a lot more secure, and eliminates posts turning.



GATE



Milk Gate

The Jourdain milky gate is a three-bar gate designed specifically for use in cubicle sheds. These work well with robotic scrapers as they give sufficient clearance under the gate.



GATE



Teemore Bungee Gate

Single rail spring loaded gate, ideal for dividing or directing dairy cows at the end of passageways where often a swinging gate is not an option.

GATE

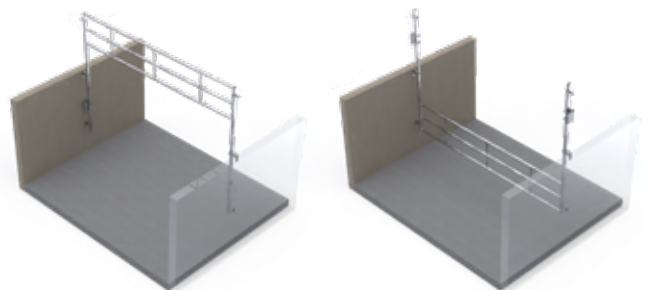
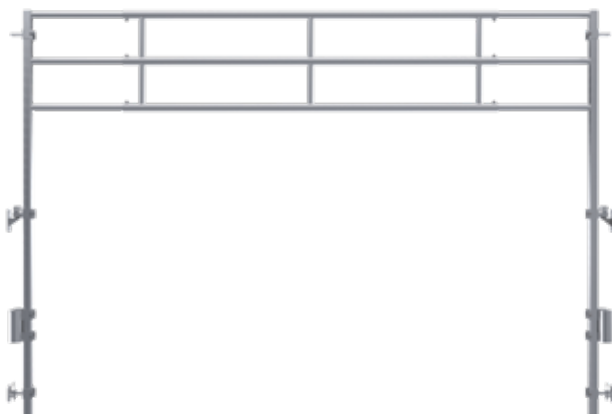

Up and Over Gate

The Teemore Up and Over gate is a fully balanced rotating gate positioned between two posts, ideal for those areas where a swinging gate is not an option.

GATE



One Way Gate

Texas style gate allows cows to pass one way only. Used extensively for cow management in robotic milking systems. Available with one or two internal gate options to ensure cows follow the correct path.



GATE

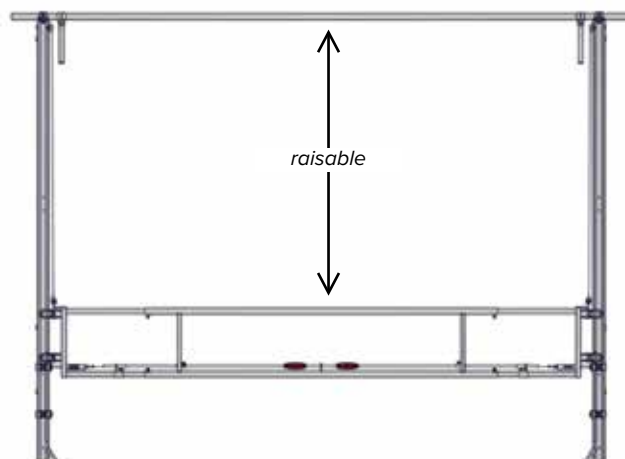

Guillotine Gate

Jourdain guillotine gate is a counterbalanced 2 bar gate ideal for dividing cubicle housing. At maximum height the gate allows for 3m under pass.



GATE



Cubicle Dividing Gate

Simple two rail adjustable cubicle dividing gate is ideal for dividing a cubicle house, separating different batches of dairy cows.



GATE

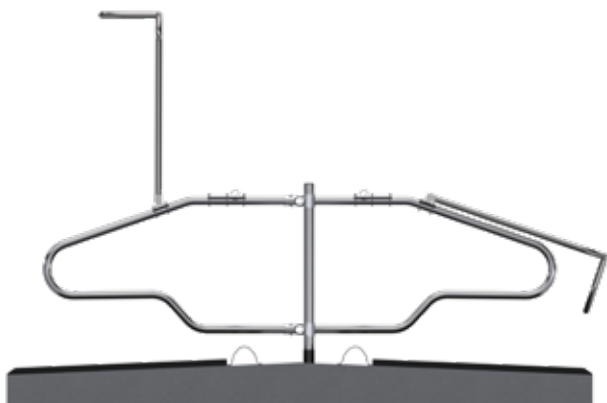

Cubicle Training Gate

The cubicle training gate can be fitted to any of our adult cubicles, to help train heifers/cows on the correct way to enter and lie in the beds.



Fixtures & Fittings

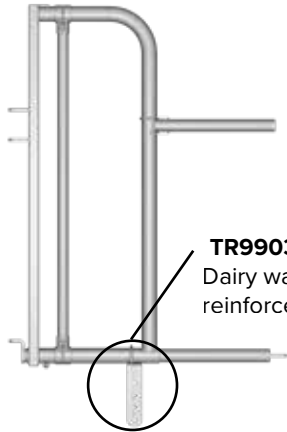

TR9903
Dairy wall
reinforcer



SQ9945
SAFETY® IV Locking stop

SQ9944
Stop

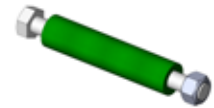

PA9904
Spacer pin



SQ9939
Individual locking pin



SQ9943
Control pipe
joining pipe



SQ9901
Dropper

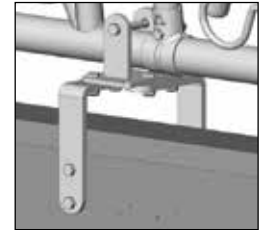

MO0260
Reinforcement for prefabricated
wall 150-200 mm

PR6001
Headlock man passage end



SQ9941
Safety IV control handle



TE 7003
Centre support on wall



TE7004
Centre support 100mm wall panel



TE8060
Feed timber
support angle

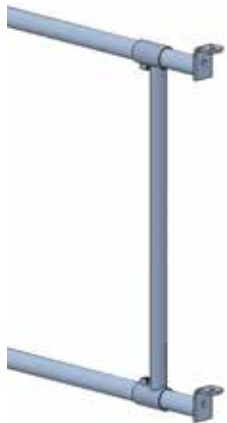

PR5052
Extension end



PR5053
Extended end
closure bar



TE7000
Timber bracket



TE7005
Centre support
76mm timber



TE8061
Channel for timber



VE2505
42/27mm Claw clamp



AT0201
42/42mm Claw clamp



PR9910
60/42mm Claw clamp



MO5050
Standard swinging end-
length - 280mm

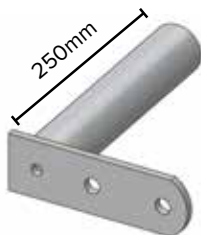

MO5052
Flat end piece -
length - 250mm



MO5053
Embossed end



MO5054
Welded Straight End -
length - 340mm

Fixtures & Fittings

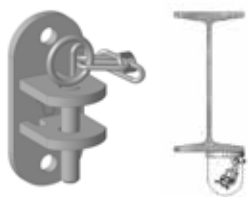

FE2102
Flat hanger
(pair)



FE2102S
Flat hanger slotted
(pair)



FE2104
3" Spacer hanger
(pair)



FE2104S
3" Spacer hanger
slotted (pair)



FE2105
2" Spacer hanger
(pair)



FE2105S
2" Spacer hanger
slotted (pair)

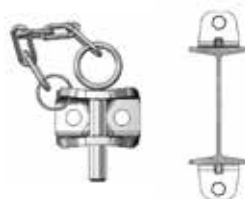

FE2117
Multi fix bracket
(pair)



TE8127
RSJ centre latch
receiver (pair)



TE7018
Swing over gate bracket

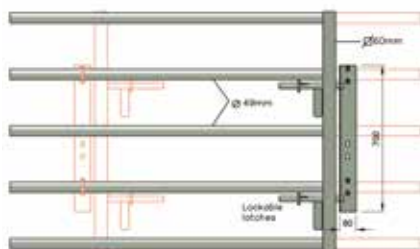

TE8065
4 & 5 Bar centre latch over-lapping
gate bracket

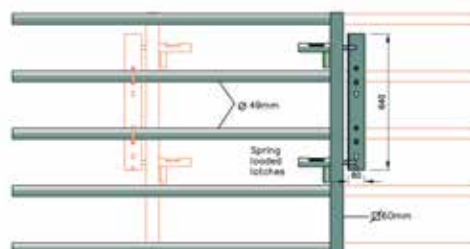

TE8064
4 & 5 Bar spring latch over-lapping
gate bracket



TE8128
RSJ side edge receiver
(pair)



TE8126
RSJ side latch
receiver (pair)

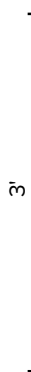

TE6000
Long wall
hanger



TE7007
2.1mtr RSJ
post 7"x4"



TE6997
2mtr RSJ
post 6"x6"



FE2112
Wide wall
hanger (pair)



TE7019
Drop latch

GATE

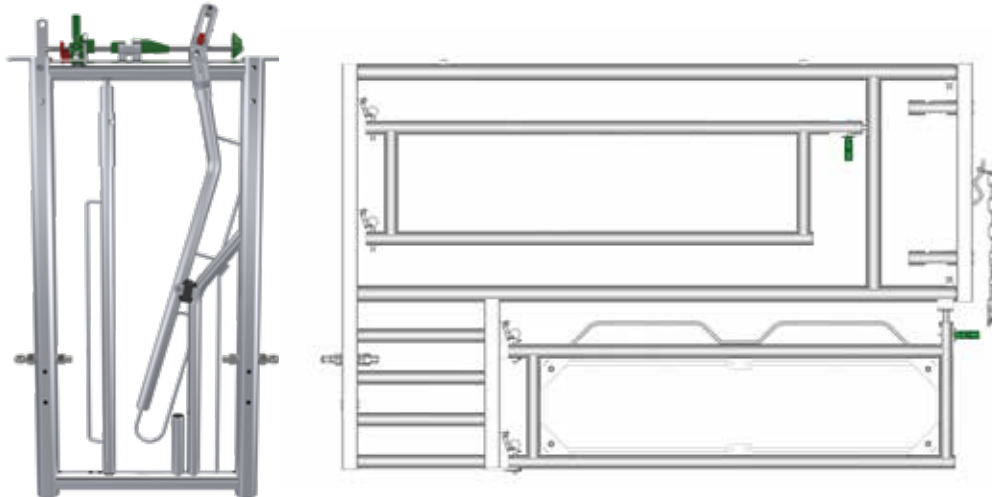

Automatic Calving Yoke with Operation Gate

The Jourdain Single calving yoke coupled with the operation gate are ideal for single calving pens. The yoke with the quick release mechanism and the lower bottom bar ensures the animals safety during calving.



GATE

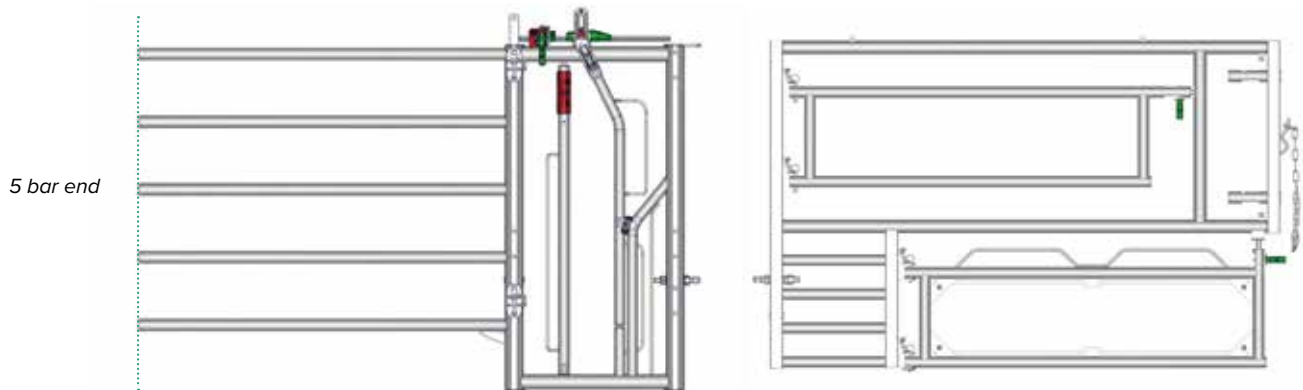

Ex 5 Calving Gate and Operation Gate

The Telescopic Jourdain Ex 5 Calving yoke can be incorporated into any of the 5 bar backs to create a pen divide. Hangers can be mounted on either side of the yoke on which to mount the operation gate.



GATE

5 bar end

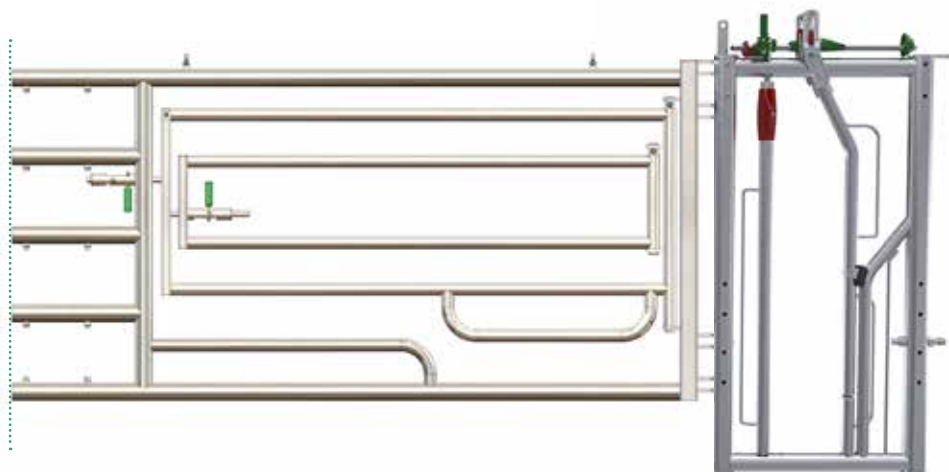

Automatic Calving Yoke with 2 in 1 Gate

The telescopic 2 in 1 calving gate is ideal for dividing 2 calving pens and can be coupled with the Jourdain head locking yoke leaving it accessible from both sides. 2 in 1 calving gate can be paired with any of the 5 bar ends.



GATE

5 bar end

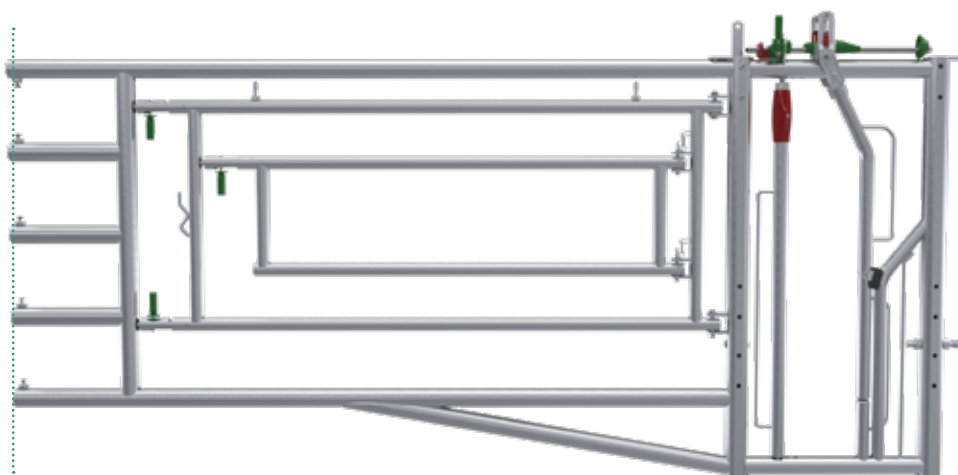

3 in 1 Calving Gate

The Jourdain 3 in 1 calving gate is suited to divide two pens as the cow can enter the head yoke from either side. The built in operation gate can swing either direction so the gate can service both pens..



GATE

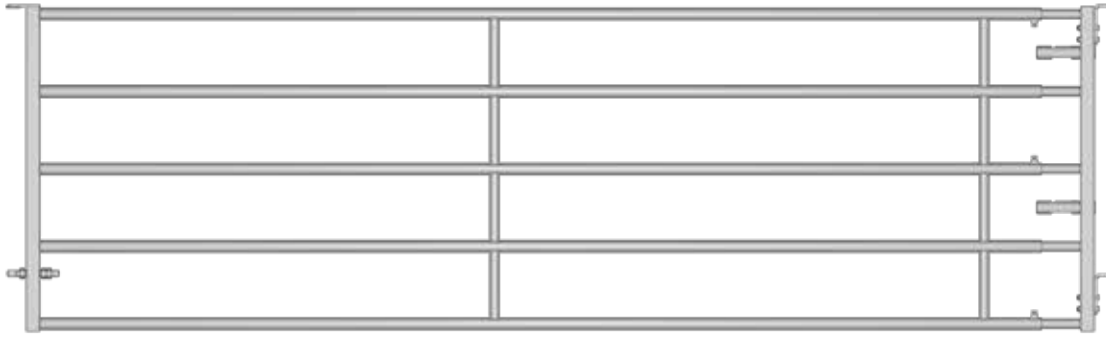

Field Panel

Teemore's country style field gates are suitable for use in gaps ranging from 3.65m – 4.87m. Ideal for entrances to fields around the farm.

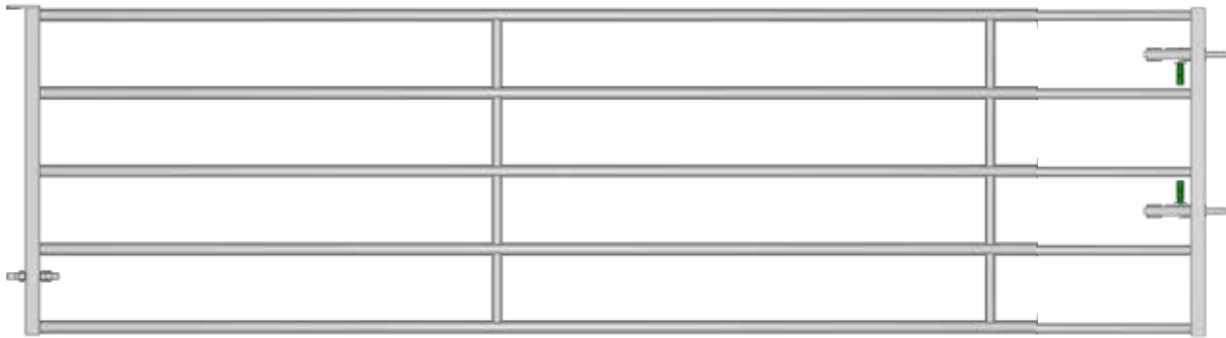

Spring Latch Field Gate

Jourdain telescopic 5 bar field gate is commonly used for field access or smaller animal sheds. The Jourdain auto-lock latch ensures secure yet easy to use closure.

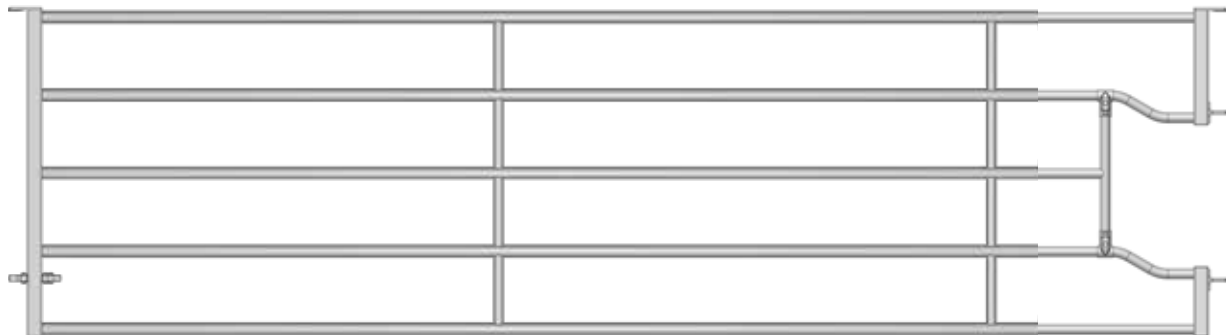

Drinker Bowl Field Panel

Jourdain telescopic 5 bar drinker bowl panel is ideal for dividing pens of small animals allowing them to share a drinker between the 2 groups.



GATE

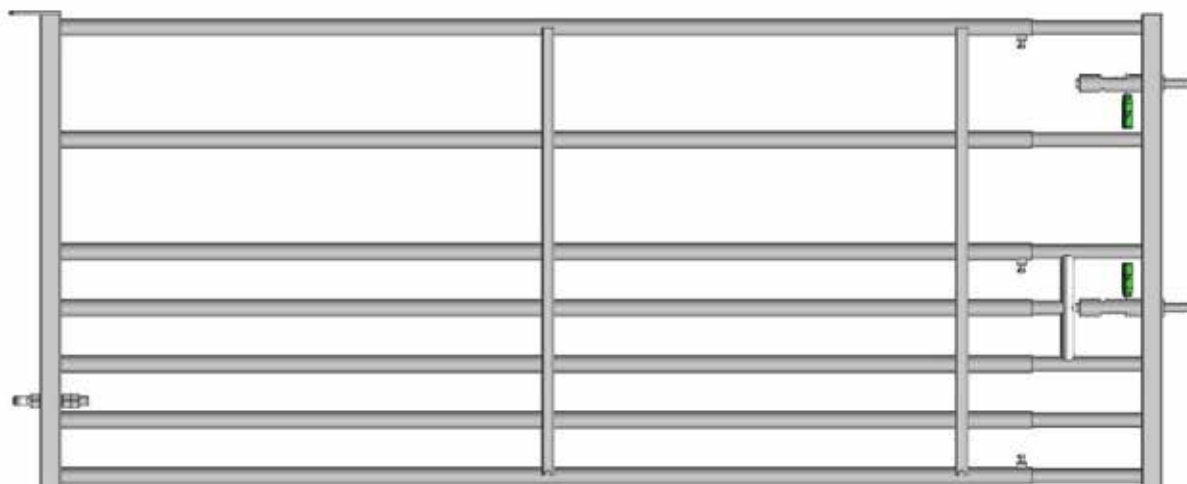

7 Bar Gate / Panel

7 bar gates designed specifically for use in fields or for small animal housing designs. The lower five bars have a 95mm spacing, preventing smaller animals from catching their head between bars.



GATE



Extendable Sheeted Doors 5ft + 6ft

Extendable sheeted doors are premanufactured on-site and sheeted once the specific size required is available. Made from 60 x 60mm with 50 x 50mm box insert, with double spring latches for secure closure.



DAIRY PRODUCT BROCHURE

CUBICLES

WORKING WITH DAIRY FARMING EXPERTS,
WE CONTINUE TO DEVELOP INNOVATIVE
COW CUBICLE SOLUTIONS TO SUIT THE UK
AND IRISH DAIRY FARMING MARKETS.

CUBICLES

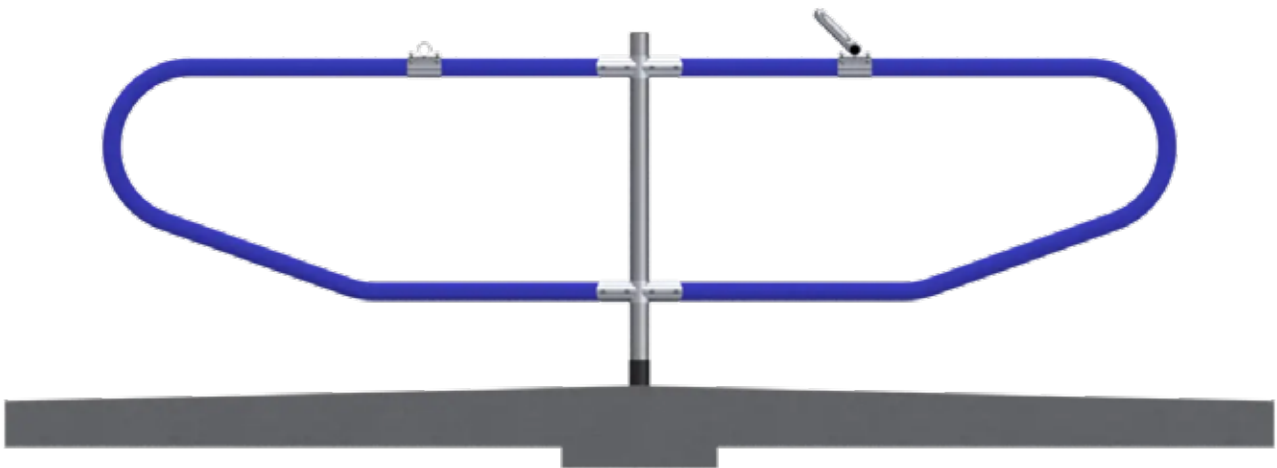

Plastic Cow Cubicle

The new Teemore plastic flexible cubicles offer the cow greater comfort when lying down yet maintain the correct lying position. When the cow rests against the loop it flexes a little as not to injure the animal but still ensures they can't turn round.

- Single post mounting
- Flexibility where its needs
- Patented clamps

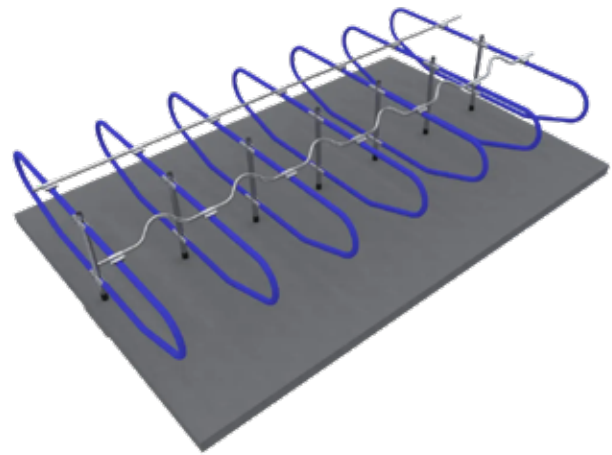

CUBICLES



Super Loop Cow Cubicle



Super loop cow cubicles were the first cantilever cubicle designed and manufactured by Teemore Engineering, developing an excellent reputation for comfort and quality amongst farmers.



CUBICLES

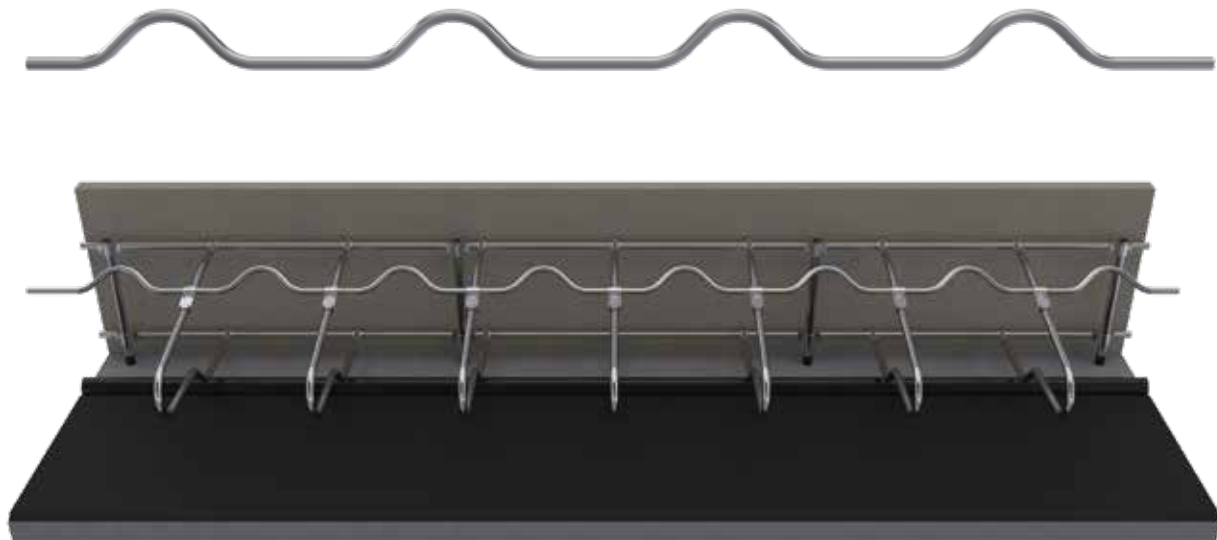

Zig-Zag Head Rail



Zig zag neck rail increases neck rail height in the centre of each cubicle, creating a comfortable standing position, straighter lying and promotes cleaner cubicles. Can be retro fitted onto low neck rail cubicles to increase cow comfort.

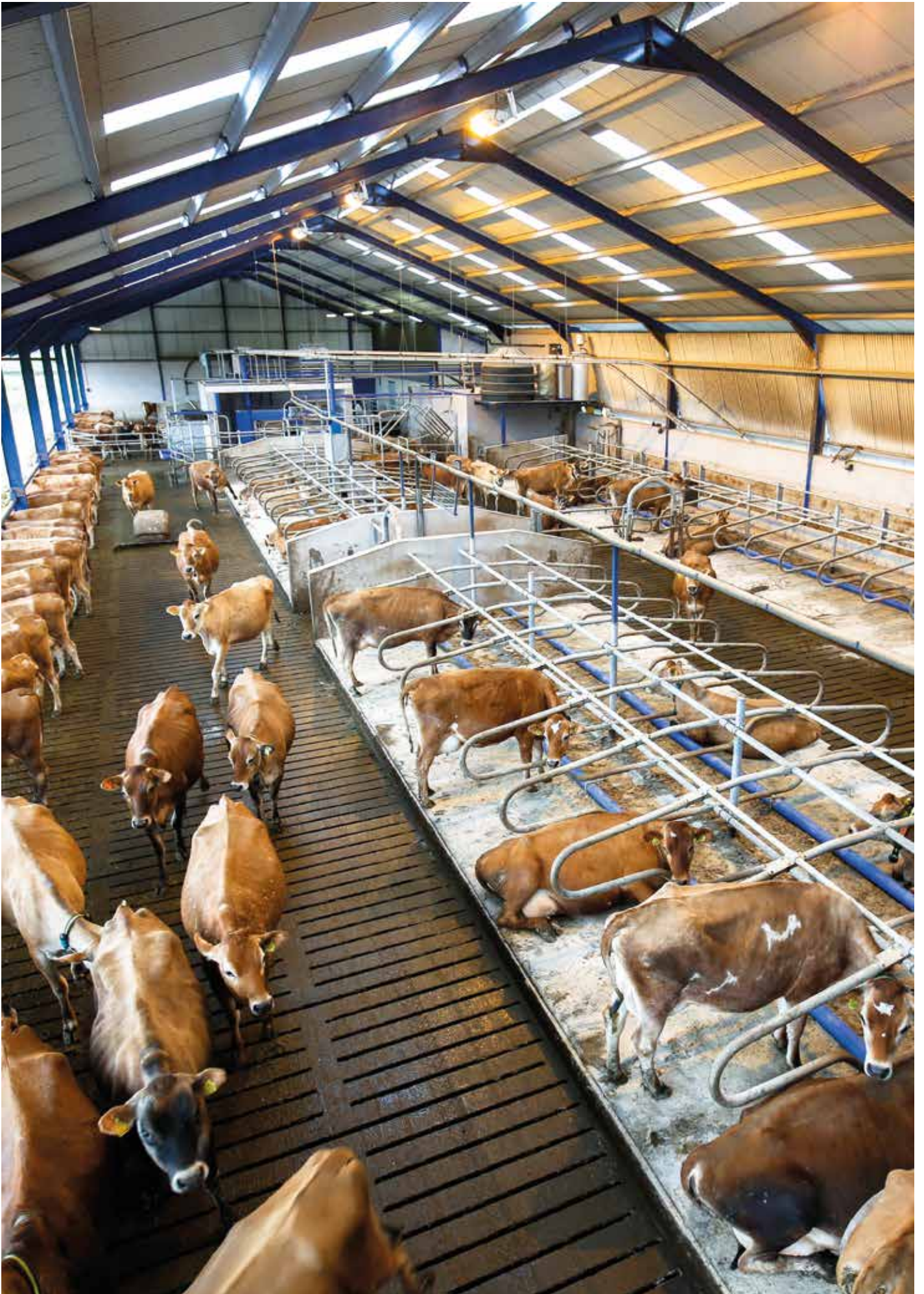

CUBICLES

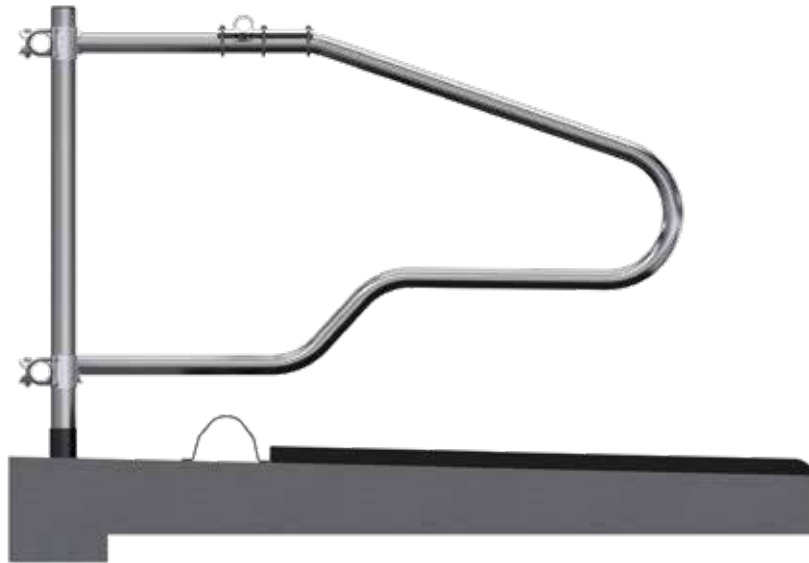

**Super Loop Plus
Cow Cubicle**



Super loop plus cubicles is a higher neck rail version of the super loop. High neck rail cubicles offer greater access into the cubicles allowing the cow to stand up on all 4 feet prior to lying down, reducing the stress on the cow's hind legs.



CUBICLES

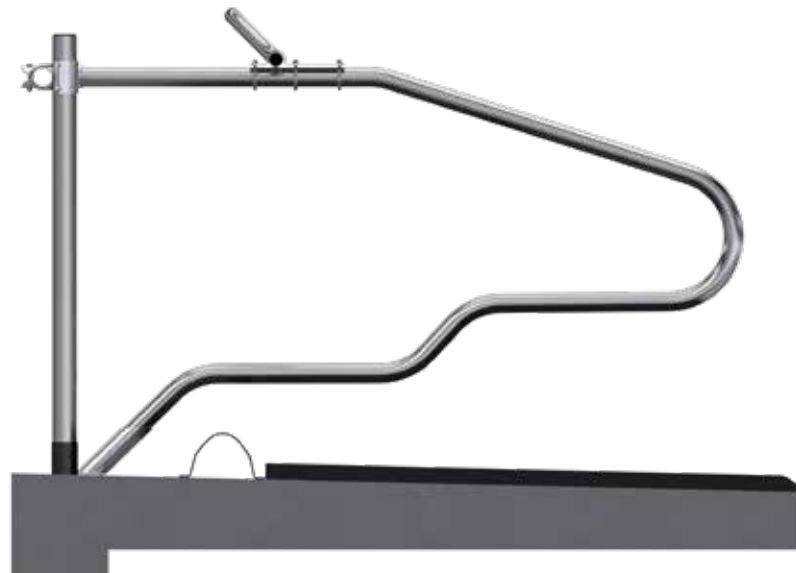

Deluxe Cow Cubicle



Deluxe cow cubicles are high neck rail open fronted cow cubicle mounted on a floor bracket maximizing lunging space with no bottom rail. With a 1250mm head rail height makes them the ideal solution for the large modern dairy cows.

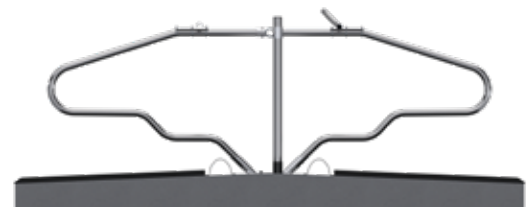

CUBICLES

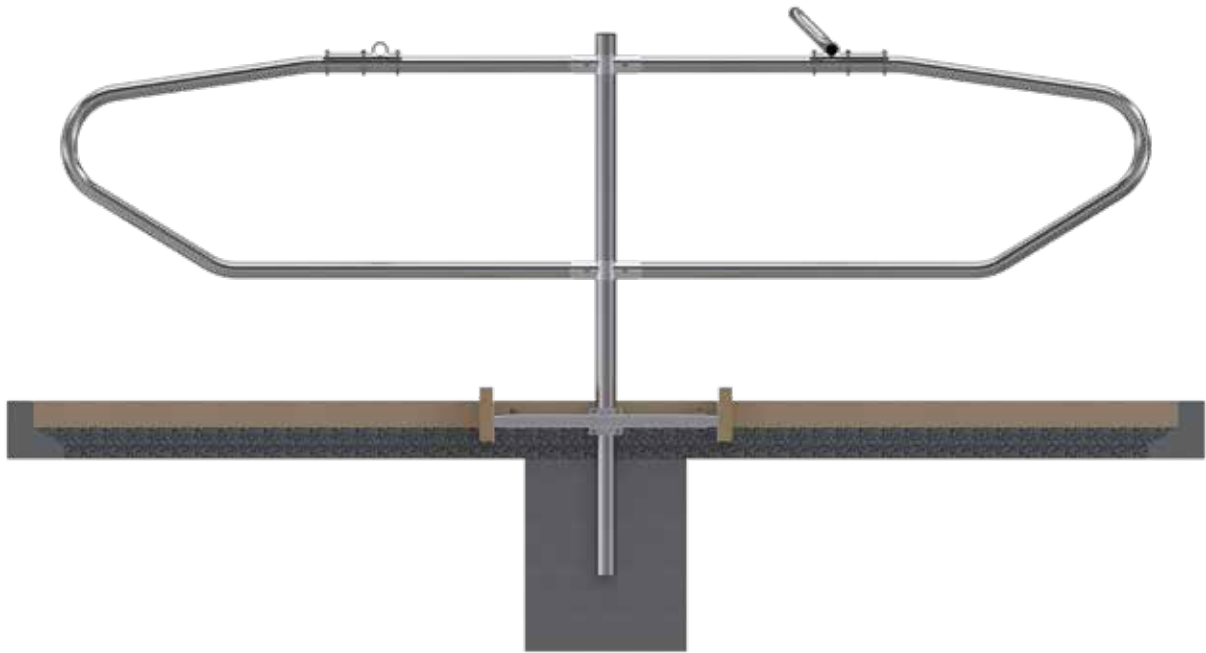

Elite Sand Cubicles

Elite sand cubicle specifically designed for use with deep bedded systems. With a straight lower leg, the loop forces the cow to lie straight which in turn promotes cleaner beds. Mounted on a single post system assures an unrestricted lunging area.

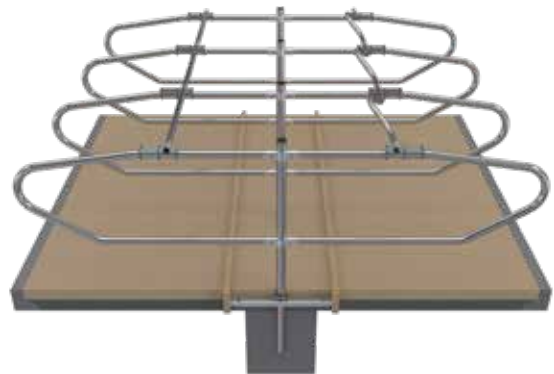

CUBICLES



Concrete Heel-Stone Kerb

Precast Concrete heel stone kerb designed for fast installation using two hold-down bolts with a perpendicular inside surface helping to reduce sand loss into passageways. Smooth inner surfaces at cow contact point to improve cow comfort.

CUBICLES

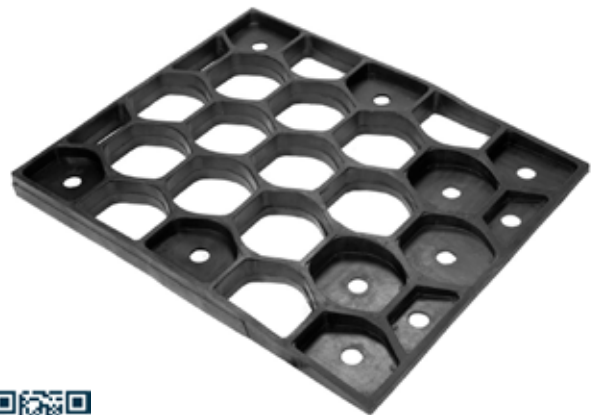

Sand Saver Mat

100% natural rubber mat designed to reduce sand loss while still maintaining cow comfort.

CUBICLES

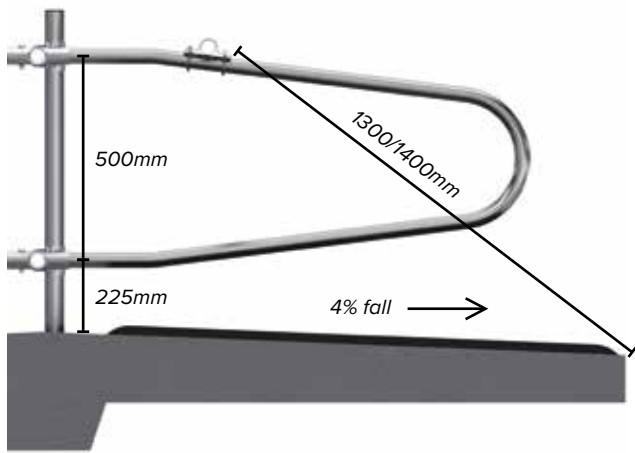

- 48mm Tubing
- 60mm Posts
- 500mm Cubicle Depth



0-6 Month Calf Cubicles

There is no better time to train young heifers to lie in cubicles, than when they have been weaned. Not only does this ensure that they all lie up, but is also a very cost-effective method of housing, by reducing bedding.

CUBICLES

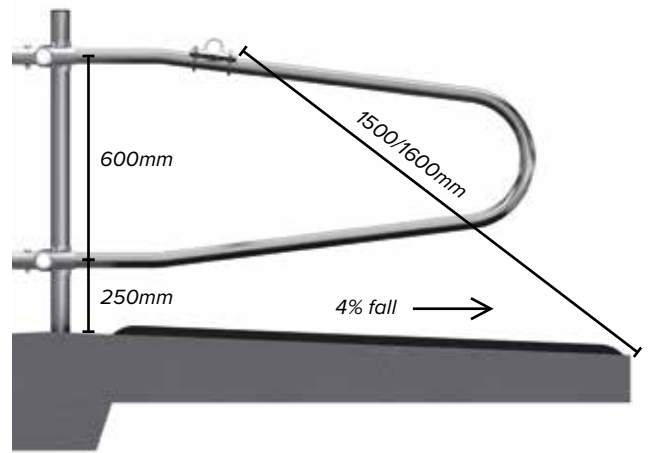

- 48mm / 60mm Tubing
- 60mm Posts
- 600mm Cubicle Depth



6-12 Month Heifer Cubicles

Depending on your specific farming policy 6–12-month heifer cubicles normally accommodate the spring born calf going into the house for their first winter. This is an ideal time to train youngstock to lie in cubicles.

CUBICLES

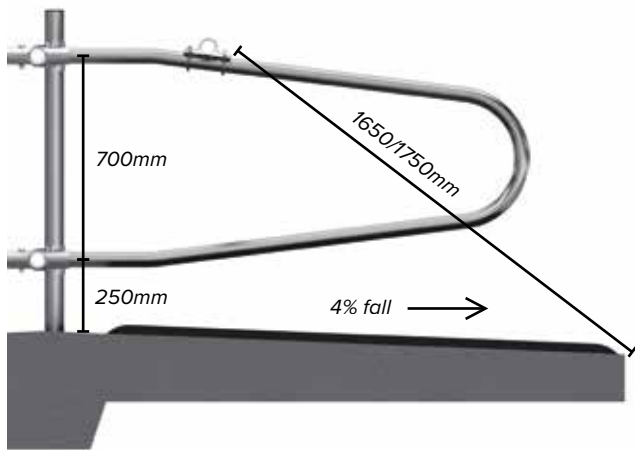

- 60mm Tubing
- 60mm Posts
- 700mm Cubicle Depth



12-18 Month Heifer Cubicles

12–18-month heifer cubicles normally accommodate heifers in their second winter, and during insemination period. Welfare and comfort are essential during this period to maximise fertility.

CUBICLES

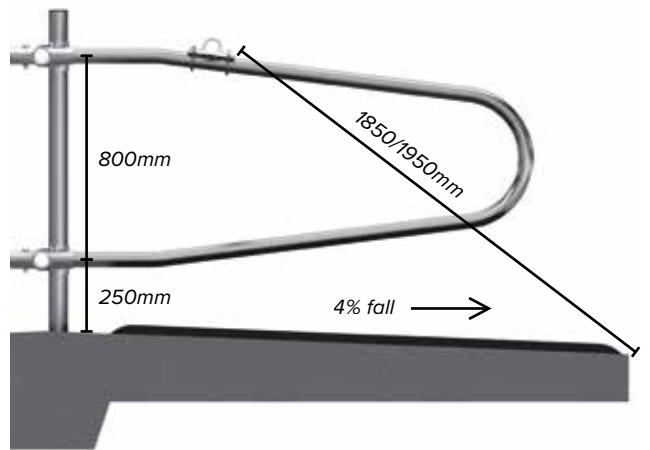

- 60mm Tubing
- 60mm Posts
- 800mm Cubicle Depth



18-24 Month Heifer Cubicles

18–24-month heifer cubicles normally accommodate in calf heifers where welfare and comfort are of upmost importance. The fully adjustable system provides the necessary flexibility required to suit all stock types.

CUBICLES



Plastic Pillow

Robust plastic pillow positioned at the front of cubicle to ensure correct lying position, significantly reducing the number of dirty cubicles. The plastic mould provides optimum comfort & minimises the risk of injury in the cubicle.



CUBICLES

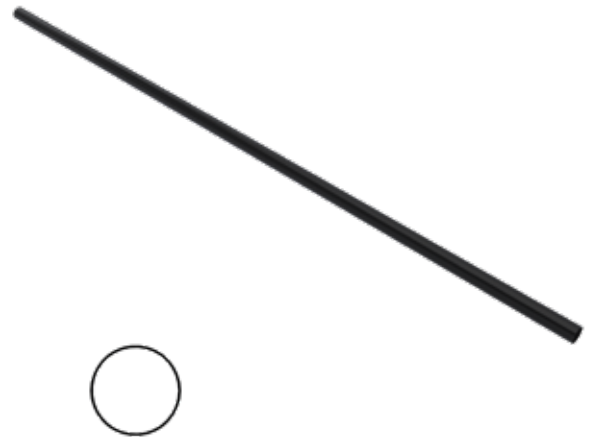

Bricket Pipe

125mm heavy duty plastic bricket pipe, can be mounted to either the cubicle or floor using galvanised brackets. Mounting to the cubicle allows full adjustment to suit all cow types.



CUBICLES



**Bricket Board
Timber Bracket**

Adjustable bracket, U-bolting to the bottom of cubicle loop, for attaching timber to act as a bricket board mounted at 45-degree angle to cubicle bed.



CUBICLES



**Sand Bed Bricket
Board Bracket**

Telescopic Adjustable bracket which is U-bolted to the side of the post for attaching timber board at 90-degree angle to cubicle bed. One bracket every second cubicle post.



DAIRY PRODUCT BROCHURE

MATS & MATTRESSES

WE CARRY A RANGE OF COW MATTRESSES THAT ALLOW YOUR HERD TO FEEL SAFE AND SECURE IN A CLEAN AND COMFORTABLE ENVIRONMENT, WITH CONFIDENCE IN THEIR FOOTING.

MATTRESSES

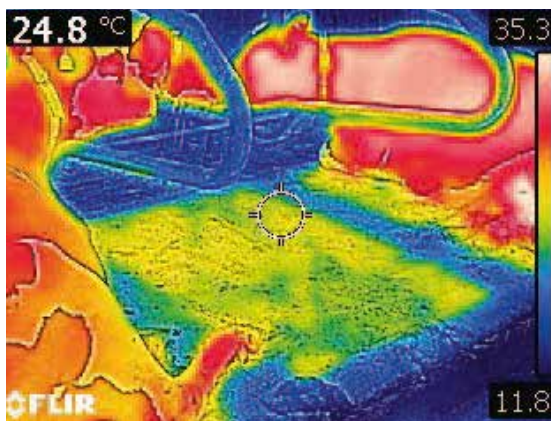
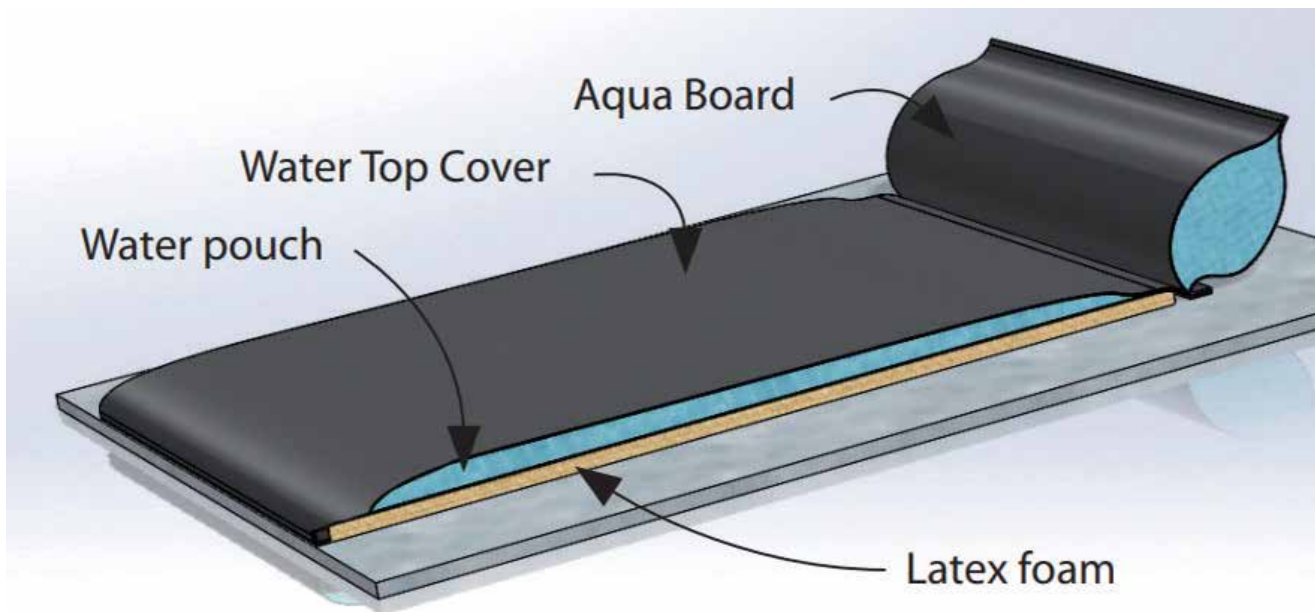

This heat map illustrates the contrast in temperature between the air and the water mattress, highlighting that the mattress maintains a refreshing cooler temperature of 10 degrees Celsius.



Aquastar Ultimate

Aquastar Ultimate is a water-based mattress which comes complete with a water filled brisket tube which aims to provide the best possible comfort for your cows. Each cubicle bed within this mattress roll has an individual water chamber; this ensures the water is distributed evenly around the cow to obtain the 'floating' affect, supporting optimised blood circulation and increased milk production.

MATTRESSES

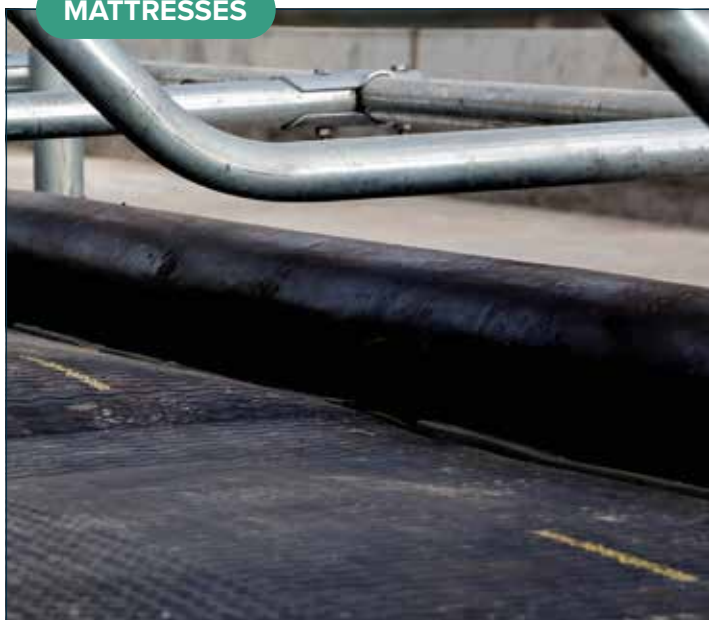

Aquaboard

The first water knee board in the world. The Aqua board consists of a water tube attached to the front of the mattress; water pressure can be adjusted to control the lying position of the cow.



AQUASTAR ULTIMATE: REVOLUTIONISING COMFORT AND HEALTH IN A DAIRY FARM

Introduction: In this captivating case study, we delve into the story of a dairy farm that made a significant investment in improving cow comfort and overall herd health. By installing 78 spaces of the Aquastar Ultimate, supplied by Teemore Engineering, the farm underwent a remarkable transformation, leading to exceptional results and numerous benefits.

Challenges Faced: The dairy farmer recognised the need for upgrading their existing mattress system, as the outdated rubber covers provided inadequate comfort and support to the cows. Seeking a solution, they engaged in a conversation with Philip Gillespie, the Teemore representative for the area. The farmer expressed concerns about the pressure on the hooves when cows rose from the concrete below the water pouch, a common issue associated with water mattresses.

The farmer reported a significant reduction in mastitis cases within the herd, attributed to the reduced pressure on the udder facilitated by the “floating” effect of the water-based mattress.

The Aquastar Ultimate Solution: Philip Gillespie highlighted the immense benefits of the Aquastar water mattress, which not only increased cow comfort but also kept maintenance costs low. To address the farmer’s concerns, Teemore Engineering had incorporated the same foam inlay used in their popular mattress products, the Elista and Optima, into the Aquastar Ultimate. This innovative feature improved the cow’s locomotion, providing an optimal environment for their well-being.

Results and Benefits: Six months after the installation, the farm witnessed remarkable improvements in cow appearance and performance. Cows housed in the Aquastar Ultimate sheds appeared cleaner in comparison to those in ordinary mattress cubicles. The farmer reported a significant reduction in mastitis cases within the herd, attributed to the reduced pressure on the udder facilitated by the “floating” effect of the water-based mattress. Additionally, the water mattress efficiently directed any liquid towards the alley, eliminating the problem of milk pooling in the beds.

The calm and content demeanor of the cows was evident while walking through the cow house, as they peacefully chewed on their cud. The Aquastar Ultimate also proved invaluable in combating heat stress, particularly during the summer months. By efficiently transferring heat from the cows to the mattress, the system reduced the energy required for cooling, allowing the cows to allocate more energy towards milk production.

The Aquaboard brisket, an integral part of the Aquastar Ultimate combination, played a crucial role in supporting the cows and reducing lameness within



CASE STUDY

Client: George Mitchell

Location: County Down

Date Completed / Timeframe: Summer 2021

Products Used: Jourdain Headlocks, Aquastar Mattress, Teemore Cubicles, Teemore Fast Empty Drinkers

the herd. As a recurring customer, the farmer expressed immense satisfaction with this feature.

Conclusion: The installation of the Aquastar Ultimate has revolutionised cow comfort, increased milk production, and significantly enhanced animal health on this dairy farm. Through the adoption of this innovative solution, incidents of lameness and mastitis have been greatly reduced, positioning the Aquastar Ultimate as a pioneering contribution to the farming industry. The case study serves as a testament to the commitment of Teemore Engineering in prioritising comfort while driving substantial improvements in productivity and overall herd welfare.

MATTRESSES

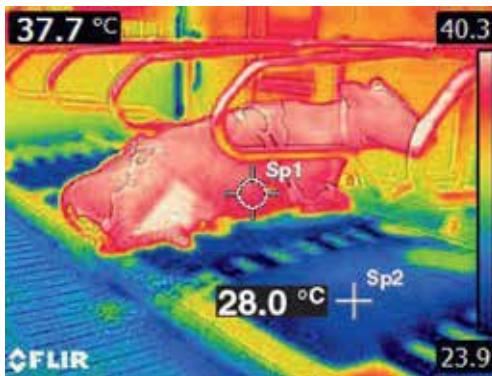
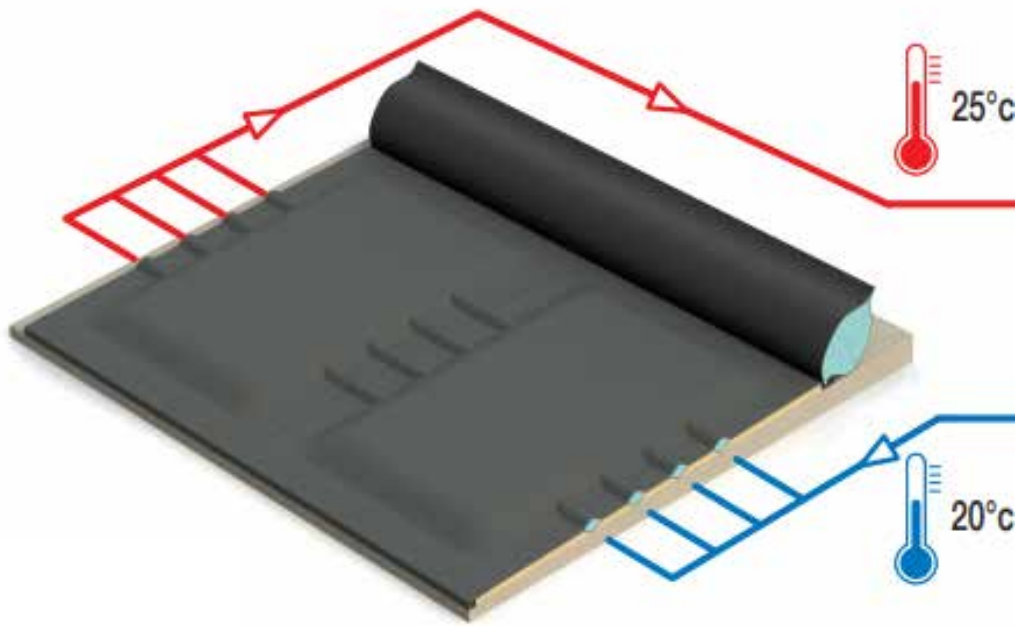

This heat map illustrates the contrast in temperature between the air and the water mattress, highlighting that the mattress maintains a refreshing cooler temperature of 10 degrees Celsius.

Aquaclim Mattress



The solution to combat heat stress. The Aquaclim mattress is a combination of high-density latex foam, a water pouch with under channels to circulate water. The water pouch acts as a heat exchanger taking the heat away from the cow.



MATTRESSES

- 650kg/m³ (density)
- 40mm Thickness with Cover
- 1,700mm Depth



Louisiane Mattress

This high-density butyl rubber mattress system offers a robust yet comfortable mattress when covered with our new generation top cover. This resin bound rubber underlayment guarantees a stable and consistently level easy clean surface.



MATTRESSES

- 300kg/m³ (density)
- 60mm Thickness with Cover
- 1,750mm Depth



Optima Mattress

The double layer, 60mm thick, mattress system is the first continuous mattress to be developed with a unique 4% built-in slope at the heel stone. This slope allows liquids to drain off at the rear ensuring a dryer, cleaner mattress top.

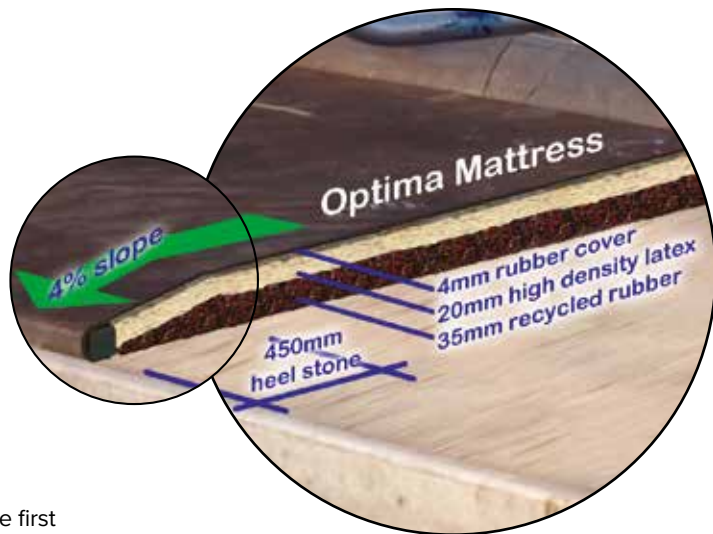

MATTRESSES

- 300kg/m³ (density)
- 40mm Thickness with Cover
- 1,700mm Depth



Elista Mattress

A high density 100% latex mattress system designed to maximise heifer comfort. Covered with the new generation non slip top cover ensures an easy clean hygienic top surface.



MATTRESSES

- 240kg/m³ (density)
- 45mm Thickness with Cover
- First Generation Top Cover



Tempa Mattress

Tempa mattress is a 45mm thick, 100% latex mattress system. Covered with the 1st generation top cover, which has a granulated surface, this mattress provides grip and longevity.

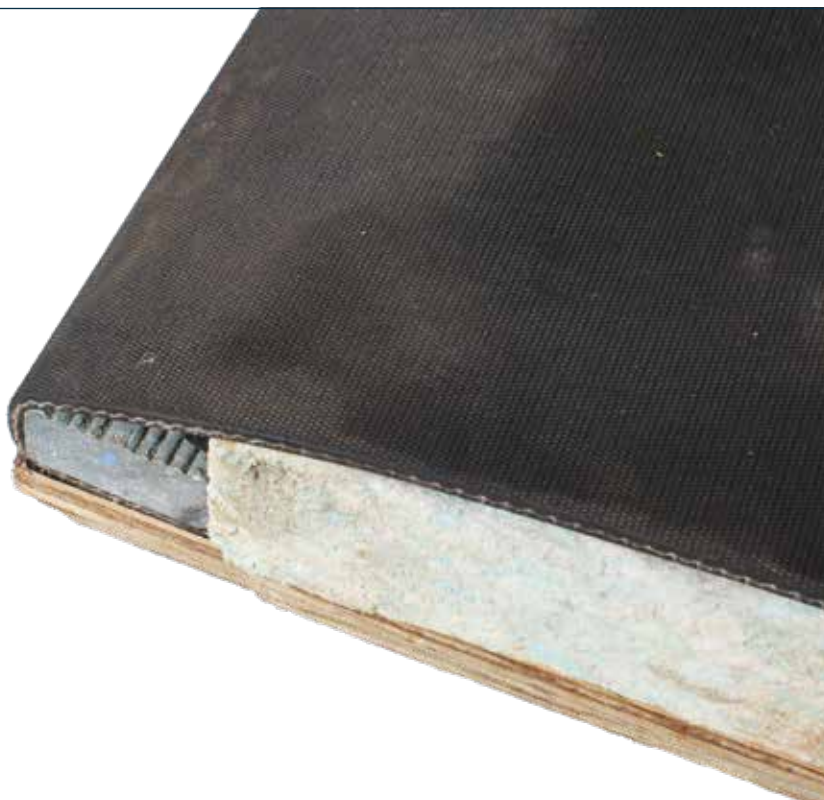

MATS

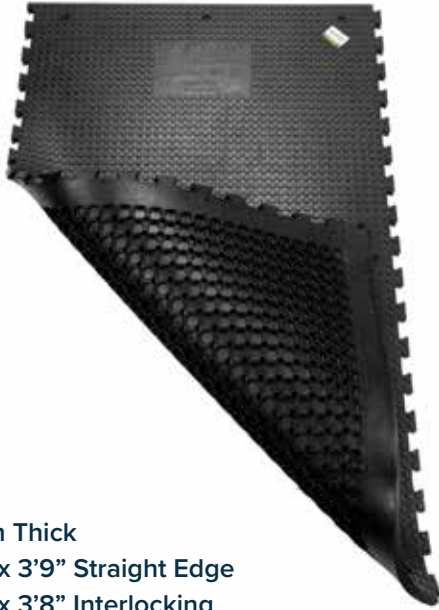

- 23mm Thick
- 5'10" x 3'9" Straight Edge
- 5'10" x 3'8" Interlocking



Standard Cow Mat

The standard cow mat provides a good level of cow comfort suitable for dairy and suckler cows. The underside has a honeycomb design providing shock absorption with a hammer top design for increased grip.

MATS



- 17mm Thick
- 5'10" x 3'9"



Economy Cow Mat

The economy cow mat is a straight edge rubber cubicle mat. Ideal for shorter housing periods giving a vast improvement over concrete. This mat is 17mm thick with small impact studs on the bottom side.

MATS



- 30mm Thick
- 1.8m x 1.14m
- 4% Slope



Interlocking Super Soft Mat

The super soft interlocking cow mat with a studded under surface provides maximum comfort for the modern dairy cow. This mat is 30mm thick, and 1.8m long. Spacers are available to ensure the mat aligns with the cubicle space.

MATS



- 38mm Thick
- 1.8m, 1.7m or 1.5m Depth
- Continuous Roll



Studded Rubber Roll

Continuous 18mm studded roll is ideal for use in cow, heifer and calf cubicle with sizes available to suit the various bed lengths. This continuous roll system is ideal for non-standard cubicle widths.



Silage Pit Bags



The Silage Pit Bags are an environmentally friendly alternative for covering the base layer of polythene on grass or maize silage pits.



Dairy Scratchy – Rubber Animal Scratcher



The dairy scratchy allows cows to satisfy their natural need to scratch in order to shed parasites, scabs and mites. Ideal for farms where tail painting is used as a method of heat detection.

DAIRY PRODUCT BROCHURE

RUBBER FLOORING

AT TEEMORE WE OFFER RUBBER FLOORINGS WHICH NOT ONLY SIGNIFICANTLY IMPROVE THE GRIP AND COMFORT FOR THE ANIMALS BUT SOME HAVE BEEN PROVEN TO REDUCE AMMONIA

RUBBER FLOORING

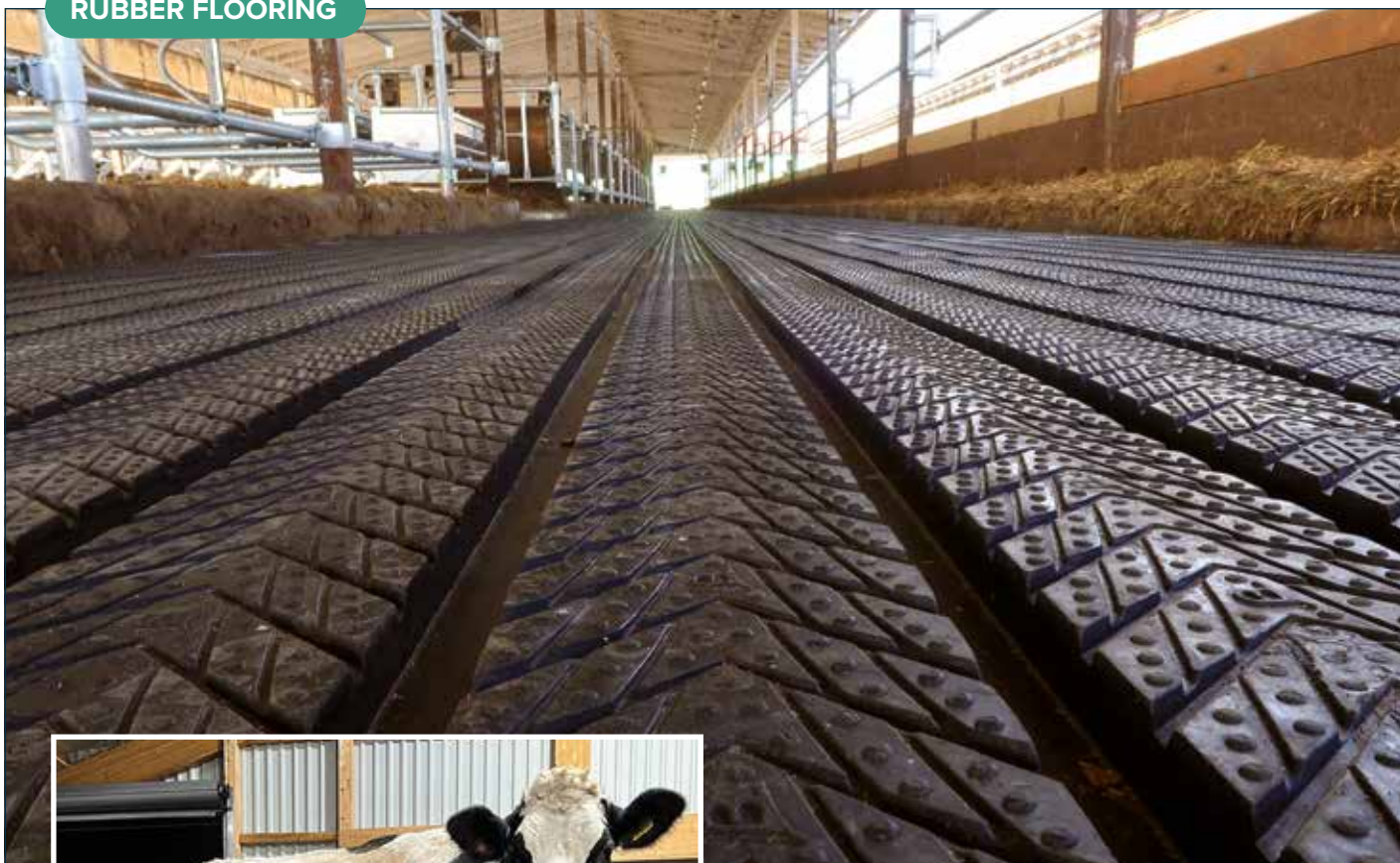

Magellan 25mm

Magellan is a grooved rubber flooring designed to separate the urine from the manure and with frequent scraping will reduce ammonia by 40%. The superior grip coupled with the drier surface reduces foot injuries and infections. Magellan is the good for both the animal and the environment



Magellan 16mm

The 16mm Magellan is rubber roll similar to the 25mm just doesn't hold as much liquid in the grooves. Its commonly used on the raised cross over passages between cubicle beds to give the cows similar grip to that of the 25mm. It's also commonly used around the waiting area for robotic milkers where more cow activity takes place, reducing the risk of injury.

SUSTAINABILITY IN FARMING

To find out how **Magellan Flooring** contributes to a more sustainable approach to farming, go to teemoreengineering.com/sustainability or scan the QR code on your smart device.





FARMING FOR THE FUTURE: MAGELLAN RUBBER FLOORING, UPLIFTING SUSTAINABILITY IN AGRICULTURE

In 2022, a farm located in County Down, Northern Ireland, partnered with Teemore Engineering to enhance their cow comfort and grip within their shed environment. The primary goal of the project was to improve the well-being of the cows, particularly around feeding barriers. Teemore Engineering provided a comprehensive solution, including Teemore cubicles, Jourdain headlocks, Bioret Mattress, and Magellan flooring.

Once the installation was complete, a small group of dry cows had the opportunity to experience the benefits first-hand. The cows were delighted by the reliability and support offered by the Magellan flooring, which significantly improved their mobility throughout the shed. This was particularly crucial for this specific group of cattle, as they were in early gestation and required additional nourishment and rest.

The implementation of Teemore Engineering's solution not only ensured better grip and comfort for the cows but also contributed to their overall welfare during this critical stage of their reproductive cycle. The farm successfully combined cutting-edge technologies to create an environment that prioritised the cows' needs, enhancing their daily routines and optimizing their health.

The farm successfully combined cutting-edge technologies to create an environment that prioritised the cows' needs, enhancing their daily routines and optimizing their health

CASE STUDY

Client: /

Location: County Down

Products Used:

Jourdain Headlocks, Teemore Cubicles, Bioret Mattress & Magellan Flooring

Choose Teemore Engineering for innovative solutions that prioritise the well-being of your livestock. Experience the difference that our comprehensive product range can make in your farming operation. Contact us today to unlock a new level of comfort and efficiency for your cows.



RUBBER FLOORING



Feeding Step

The feeding step is a composite platform for cows, which is installed along the feed barrier, paired with dividers every two spaces.

RUBBER FLOORING



Sani-Feed

The acidic nature of animal feed has a damaging and corrosive effect of concrete, The Sani-Feed is an easy to clean barrier which protects the concrete.



RUBBER FLOORING

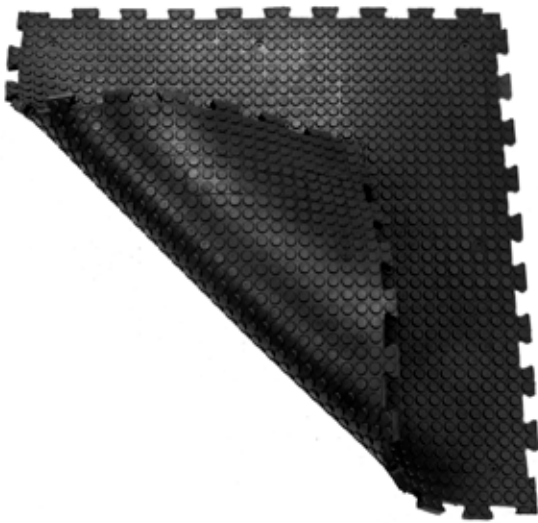

- 22mm Thick
- 1,000mm x 1,000mm
- x4 sides interlocking



Max Grip 4 & 8

The max grip mat has a penny grip surface and is ideal for use in milking parlours, walkways and collecting yards providing a comfortable confident walking surface for dairy carousel-widget.

RUBBER FLOORING



- 28mm Thick
- 1,828.8mm x 914.4mm
- 4 sides interlocking



Super Grip Dairy Mat 4 & 8

The hexagonal high grip mat has a broad range of use from parlours, collecting yards, feed areas and walkways.

RUBBER FLOORING



16mm Delta Diam Rubber Rolls



Delta Diam rubber flooring is perfect for shed passageways, parlours and holding areas. It is a rubber flooring composed of a non-slip; diamond pattern, surface, combined with grooves to facilitate liquid run-off to a central channel.

- 16mm Thick
- Custom size - made to measure
- Textile inlay to stabilise rubber

MATS



- 18mm Thick
- 2210mm Width
- Available in 4 lengths: 305mm, 610mm, 915mm, 1,220mm
- 2 sides interlocking



Toe Piece Matting

The toe piece matting is designed for high volume areas. This mat is ideal for feeding areas especially. Provides excellent grip and comfort.

MATS



- 28mm Thick
- 1,800mm x 1,120mm
- 2 sides interlocking



HD Alley Mat

Featuring a high-grip 'penny' surface, the HD Alley Mat ensures excellent traction, giving cows a secure foothold as they move around. This promotes confident and stable movement, reducing the risk of slips and falls.

RUBBER FLOORING

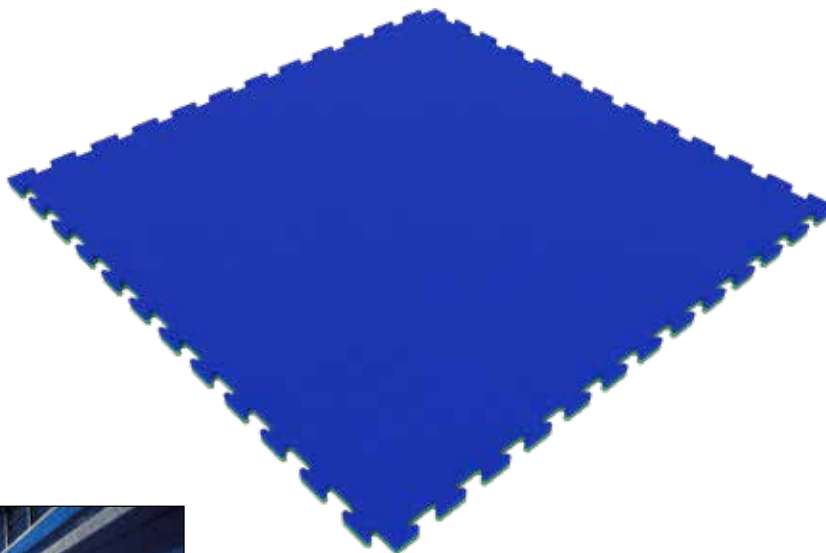
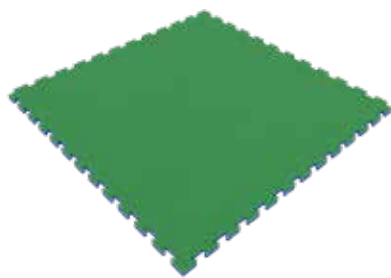

- 18mm Thick
- 1,000mm x 1,000mm
- x4 sides interlocking



EVA Parlour Pit Mat

EVA parlour pit mat has an easy clean griped finish offering maximum comfort and reduces fatigue for operator in the parlour.

RUBBER FLOORING



SR Slat Rubber

New reinforced design with a high grip profile and 5 years warranty. A wide range of sizes to suit different slat sizes, Diamond pattern with little studs provides excellent grip.



RUBBER FLOORING



SDR Slat Rubber

SDR rubber is a comfortable and smooth rubber for cows to walk on and has been tested to reduce ammonia by 30% and certified by the Vera protocol. The 2-rib rubber is fitted to slats by the solid wedges hammered into the gaps in the slats.



RUBBER FLOORING



Calving Pen Elista Mattress

The Elista calving mattress offers exceptional comfort, permanent hygiene and safety for your animals during birthing. Thanks to the rubber surface the product is waterproof, it improves sanitary conditions.



RUBBER FLOORING

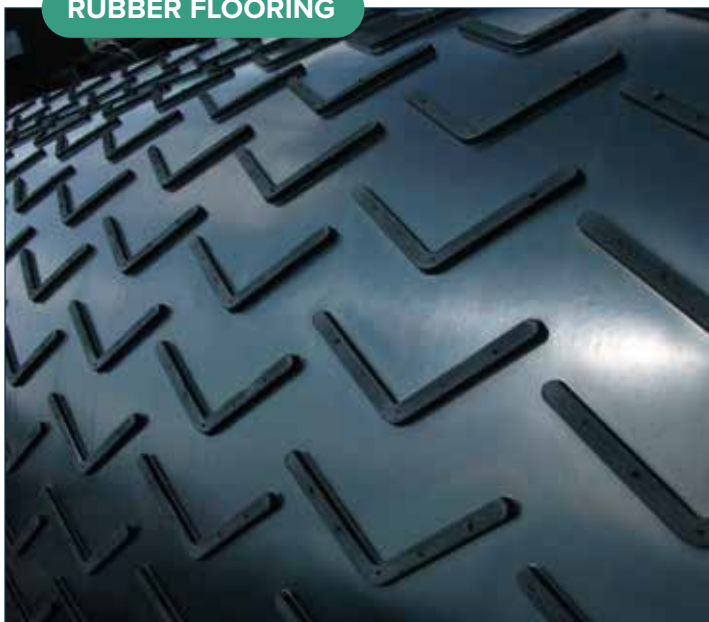

- 4.5mm Thick, 7kgm² (standard)
- 7.0mm Thick, 10kgm² (heavy-duty)
- 1,200mm or 1,800mm
- Custom length

V Rubber Ramp Matting

Heavy duty rubber roll with high grip V shapes on top surface. Ideal for steep walkways or loading ramps.



DAIRY PRODUCT BROCHURE

DRINKERS

AT TEEMORE ENGINEERING, WE SUPPLY A FULL RANGE OF DRINKERS, TROUGHS AND BOWLS TO THE AGRICULTURE MARKET THAT CATERS FOR A WIDE VARIETY OF INSTALLATIONS TYPES AND SPECIFIC REQUIREMENTS.

DRINKERS



Stainless Steel Fast Empty

The stainless steel fast empty drinker is a non-corrosive option to ensure a cleaner more hygienic water supply for your cows.

DRINKERS



Galvanised Fast Empty

The Teemore Engineering range of fast empty drinkers offer a new alternative to the traditional tip over drinker. There is a standard range of sizes with bespoke sizes available on request.

DRINKERS



2 Mtr Stainless Steel Bolt to Wall Drinker

Bolt to wall drinker with screw cap for emptying. The drinker is tapered towards the emptying valve to ensure faster flow and a better wash out.



DRINKERS



Bolt to Wall Drinker

Bolt to wall drinker with fast empty valve for easy cleaning. This centre ball valve drinker is ideal for servicing 2 pens. The drinker is fully galvanised.



DRINKERS



Teemore Stainless Steel Drinker

Single stainless-steel drinker complete with self-fill valve and bottom bung for easy draining/cleaning. Suitable for beef housing and calving pens. Water connection can be used from either side.



DRINKERS



Teemore Stainless Steel Single Bowl

The Teemore Stainless single bowl is ideal to place between two pens of beef stock, due to its stainless-steel design, paired if its ease of access for the animal to drink. Can also be easily used in heifer and calf housing units.

DRINKERS



Teemore Stainless Steel Double Bowl

The Teemore Stainless Double bowl is ideal to place between two pens of beef stock, due to its stainless-steel design, paired if its ease of access for the animal to drink. Can also be easily used in heifer and calf housing units.

DRINKERS



La Buvette Single Bowl

Single cast iron bowl with easy access ball valve.

DRINKERS



La Buvette Double Bowl

Double cast iron bowl complete with stainless steel valve cover. Ideally suited to mount between two pens.

DRINKERS



Standard Drinker

Self-filling plastic drinking bowl with optional rump rail, suitable for beef housing/ calving pen. Fitted with a bottom bung for easy drain, and water connection from the side.

DRINKERS



Nozzle Drinker

Single cast iron nozzle fill bowl that can be plumbed from either top to bottom. The drinker is operated by the animal pressing its nose into the drinker, which opens the fill valve allowing water into the bowl.

DRINKERS

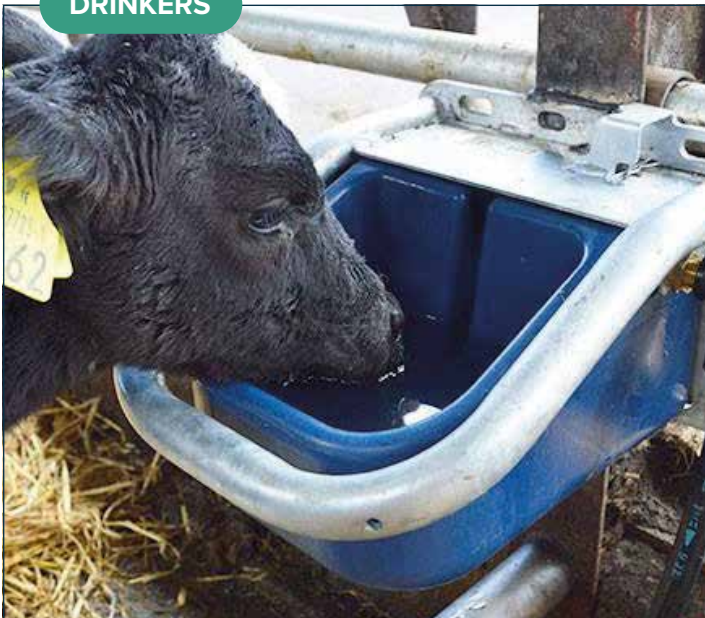

Dumpy Drinker

JFC "Dumpy Tip-over Drinker" is a 3.5 litre tipping drinker bowl that allows the farmer to empty the bowl by the press of a button.

DAIRY PRODUCT BROCHURE

CRUSHES & HANDLING

WITH YEARS OF ON-FARM EXPERIENCE, OUR TEAM CAN ADVISE ON THE MOST EFFECTIVE AND EFFICIENT OPTIONS FOR YOUR LIVESTOCK HANDLING NEEDS, FROM CALF DEHORNING CRATES TO HEAVY DUTY CRUSH AND RACE EQUIPMENT.

CRUSHES



Teemore Crush Gate

The Teemore Engineering side lever gate with 3-piece front cage is the ideal gate for working with varied stock sizes and types, and those with larger horns.

CRUSHES



Clipex Crush Gate

Clipex crush gate is a squeeze crush gate ideal for use with heavy cattle. Product is manufactured and galvanised to provide the best finish. Clipex crush gate is extremely heavy duty.

CRUSHES



Universal Crush Gate

This crush gate designed for a one-man operation with automatic locking. Robust build to suit all types of beef or dairy animals.

CRUSHES

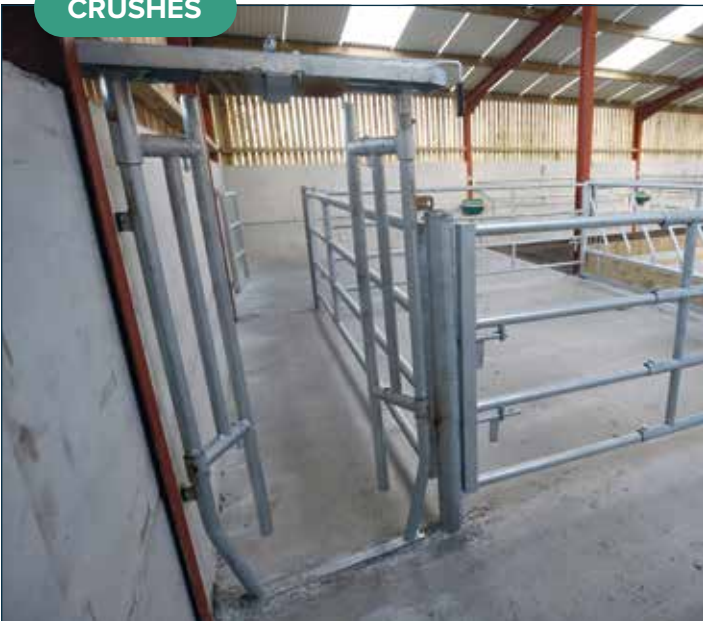

Semi-Auto Crush Gate

This popular gate is a cost-effective solution to crush all races. The semi-automatic gate is suitable for one-man operations, with simple one lever operation.

CRUSHES



Fully Automatic Crush Gate

Fully automatic crush gate, simple one-man operation, making it easier to handle larger numbers of cattle through the crush.

CRUSHES



Head Scoop

Designed to take the challenging work out of dosing and treating cattle, ensuring both operator and animal safety.

CRUSHES



Clipex Head Scoop

Designed to take the challenging work out of dosing and treating cattle, ensuring both operator and animal safety.

CRUSHES



Leg Winch

This portable system is mountable to any crush, for lifting and examining foot and leg problems.

CRUSHES



**Crush Back /
Side Access Gate**



Simple robust gate ideal for the back or side access in any crush race. Incorporating a spring latch for extra security.

CRUSHES



Guillotine Gate



This sliding gate is ideal for the back or centre of any modern handling system. Gives full control of livestock without entering the penning.

CRUSHES



Anti-backing Bar



This portable anti backing bar is ideal for retaining the animals when in the crush race. Spring loaded operation.

CRUSHES



Teemore Weigh Platform kit

Teemore's weigh platform is ideal for a fitted race and crush. Made from 4.5mm non-slip chequered aluminium and with a width of 660mm and 2139mm in length it is suited to any standard crush set-up. Kit comes as standard with WO data clock and 580/1500KG Cells.

CRUSHES



Gallagher Clocks

Gallagher's weigh-scales for animals are the first on the market to have integrated EID readers that simplify the weighing process and the collection of data from your livestock.

DAIRY PRODUCT BROCHURE

FEEDERS

DECADES OF WORKING CLOSELY WITH FARMERS MEANS OUR ATTENTION TO QUALITY AND DETAIL IS MATCHED BY THE STRENGTH AND ROBUSTNESS OF OUR FEEDERS, ENSURING THEY ARE BOTH LONG LASTING AND SECURE.

FEEDERS

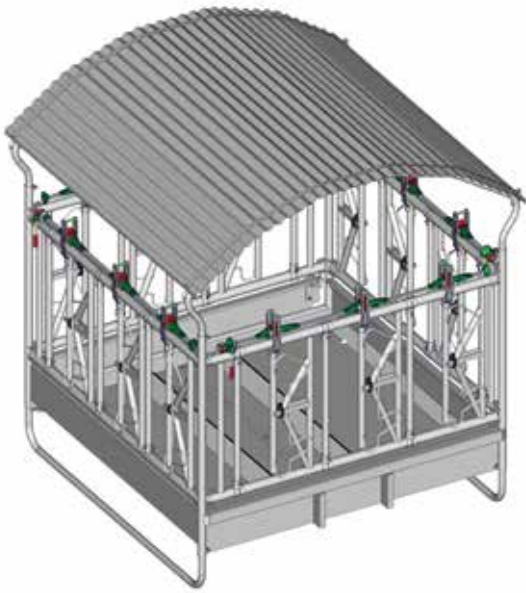

Headlock Feeder

This Jourdain covered square feeder equipped with the Jourdain safety 4 headlock is designed to catch cattle when feeding in a yard or field. This is ideal for AI or scanning, significantly reducing stress on both animal and operator.

FEEDERS



Diagonal Feeder

This Jourdain covered square feeder equipped with the diagonal barrier, reduces feed wastage when feeding bailed hay or silage.

FEEDERS



Modular Trough

This Jourdain galvanised trough system is ideal for feeding in passageways. The trough sheets can be joined together with the intermediate chairs to form a trough to create any length of trough.

DAIRY PRODUCT BROCHURE

VENTILATION

AT TEEMORE WE REALISE THAT THE VARIATIONS WITHIN THE UK AND IRISH CLIMATES DEMANDS FLEXIBILITY TO ANY VENTILATION SYSTEM.

SCREENS



Bay Screen

The Galebreaker Bay screen is the market leader for fast fit, long lasting, weather protection. Easy to install and fully adjustable, able to fit all openings.

SCREENS



Roller Screen

The Galebreaker Rollerscreen system is a spring-operated windbreak allowing for variable ventilation as well as weather protection.

DOORS

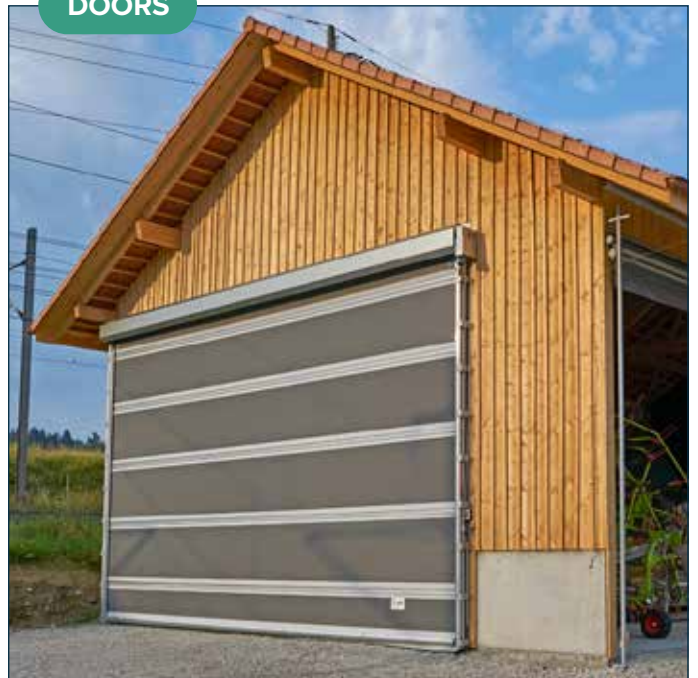

Agri Door Manual

An industry leading solution providing easy access to all types of farm buildings, the Agridoor Manual works on either the inside or outside of buildings.

DOORS



Agri Door Electric

The Agridoor Electric is a sectional, fast operating door with the features and benefits of our Manual Agridoor.

DOORS



Maxi Door

Maxidoor folding door system provides weather protection and ventilation for large openings of up to 20 metres wide. Designed for multi-purpose use, suitable for grain storage, feed stores, livestock buildings and general purpose buildings.

DOORS

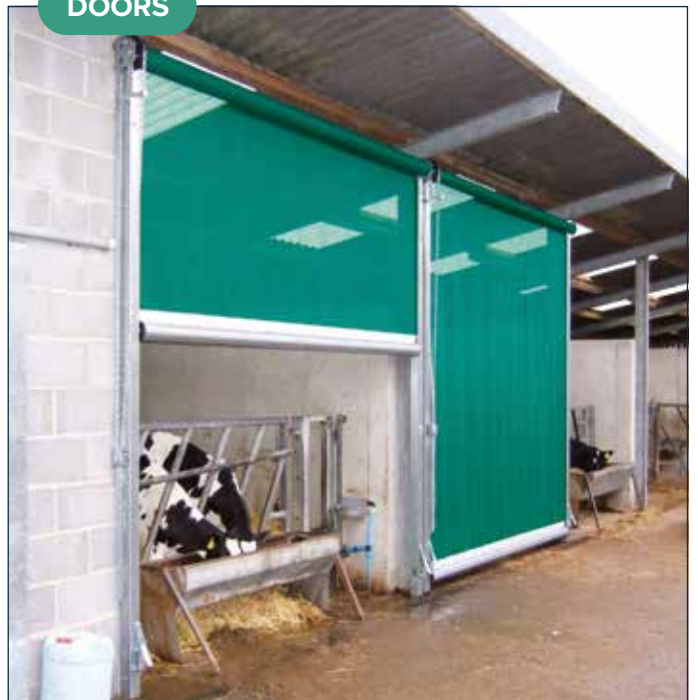

Roller Door

Fast opening, chain driven door – the safe, affordable alternative to large, sheeted doors.

PRODUCT INDEX

GATES & BARRIERS4

Jourdain Safety IV Headlocks.....	5
60mm & 76mm Diagonal Feed Barrier	6
Heifer Headlocks.....	6
Timber Diagonal Gate.....	6
Bull Headlock.....	7
Single Pipe Neck Rail & Spacer Bracket.....	7
4 Bar Standard Back.....	8
4 Bar Spring Gate	8
4 Bar Drinker Back.....	8
Surlock 101 Brackets.....	8
4 Bar Panel Gate	9
4 Bar Drinker Bowl Gate.....	9
4 Bar Man Escape Gate.....	9
4 Bar Square Gate	9
4 Bar Drinker Trough Gate.....	9
4 Bar Access Arch Gate	9
Strap Hangers	10
Octagonal Posts & Clamps	10
Hangers	10
120mm Box Posts.....	10
Milk Gate	12
Teemore Bungee Gate	12
Up and Over Gate.....	12
One Way Gate.....	13
Cubicle Dividing Gate	13
Guillotine Gate.....	13
Cubicle Training Gate.....	13
Fixtures & Fittings.....	14
Automatic Calving Yoke with Operation Gate	16
Ex 5 Calving Gate and Operation Gate.....	16
Automatic Calving Yoke with 2 in 1 Gate.....	17
3 in 1 Calving Gate	17
Field Panel	18
Spring Latch Field Gate	18
Drinker Bowl Field Panel.....	18
7 Bar Gate / Panel.....	19
Extendable Sheeted Doors 5ft + 6ft.....	19

CUBICLES20

Plastic Cow Cubicle.....	21
Super Loop Cow Cubicle	22
Zig-Zag Head Rail	22
Cubicle shed pic?.....	23
Super Loop Plus Cow Cubicle	24
Deluxe Cow Cubicle	24
Elite Sand Cubicles.....	25
Concrete Heel-Stone Kerb	25
Sand Saver Mat.....	25
0-6 Month Calf Cubicles.....	26
6-12 Month Heifer Cubicles	26
12-18 Month Heifer Cubicles.....	26
18-24 Month Heifer Cubicles.....	26
Plastic Pillow.....	27
Brisket Board Timber Bracket.....	27
Brisket Pipe.....	27
Sand Bed Brisket Board Bracket.....	27

MATS & MATTRESSES28

Aquastar Ultimate	29
Aquaboard	29
Aquaclim Mattress	31
Louisiane Mattress.....	32
Optima Mattress.....	32
Elista Heifer Mattress	33

Tempa Mattress	33
Standard Cow Mat	34
Interlocking Super Soft Mat.....	34
Economy Cow Mat.....	34
Studded Rubber Roll	34
Silage Pit Bags	35
Dairy Scratchy – Rubber Animal Scratcher.....	35

RUBBER FLOORING.....36

Magellan 25mm.....	37
Magellan 16mm.....	37
Feeding Step.....	39
Sani-Feed.....	39
Max Grip 4 & 8	40
16mm Delta Diam Rubber Rolls	40
Super Grip Dairy Mat 4 & 8.....	40
Toe Piece Matting	41
HD Alley Mat.....	41
EVA Parlour Pit Mat.....	41
SR Slat Rubber	42
SDR Slat Rubber.....	42
Calving Pen Elista Mattress	43
V Rubber Ramp Matting	43

DRINKERS.....44

Stainless Steel Fast Empty.....	45
Galvanised Fast Empty	45
2 Mtr Stainless Steel Bolt to Wall Drinker	46
Bolt to Wall Drinker.....	46
Teemore Stainless Steel Drinker	46
Teemore Stainless Steel Single Bowl	47
La Buvette Single Bowl.....	47
La Buvette Double Bowl.....	47
Standard Drinker	48
Nozzle Drinker	48
Dumpy Drinker.....	48

CRUSHES & HANDLING50

Teemore Crush Gate	51
Clipex Crush Gate	51
Universal Crush Gate	52
Semi-Auto Crush Gate	52
Fully Automatic Crush Gate.....	52
Head Scoop.....	53
Clipex Head Scoop.....	53
Leg Winch	53
Crush Back / Side Access Gate.....	54
Anti-backing Bar.....	54
Guillotine Gate	54
Teemore Weigh Platform kit.....	55
Gallagher Clocks	55

FEEDERS.....56

Headlock Feeder	57
Diagonal Feeder.....	57
Modular Trough	57

VENTILATION.....58

Bay Screen.....	59
Roller Screen.....	59
Agri Door Manual	59
Agri Door Electric	60
Maxi Door.....	60
Roller Door.....	60

TEEMORE ENGINEERING LTD

Derrylin, Enniskillen, Co. Fermanagh, N. Ireland, BT92 9BL

Tel: 028 6774 8377 (NI/UK) / 048 6774 8377 (IRE)

Email: info@teemoreengineering.com

www.teemoreengineering.com

