

Product Catalogue



www.mcveighparker.com

Contents - Click on chapter title for direct link to section.

Fencing	04
Equestrian	56
Gates	64
Farming	82
Storage Tanks	102
Water & Drainage	110
Landscape & Roofing	118
Tools & Fixings	126
Information Pages	146
McVeigh Parker Branch Details	148



WHY CHOOSE MCVEIGH PARKER?

We can deliver... on product, on price and on time!

Bulk Deals

Great Discounts

4000+ Products

Over 20 acres
of storage in
8 nationwide
locations



Knowledgeable Staff

Over 60,000m²
of storage

Fleet of over 40
delivery vehicles

With over 40
Years' Experience

Click link to right ▶
to view our complete
product range on
mcveighparker.com



Media Links

Below, a simple guide to the media
links placed throughout this catalogue:



Web
link



PDF
document



Video
link

Contact your
nearest branch -
see the back cover

Monday - Friday 7:30am - 5:00pm

(excluding Bank Holidays)

Enquiries available via email on

sales@mcveighparker.co.uk

About Us

McVeigh Parker is one of the premier specialist agricultural stockists with a reputation for innovation. Operating as an independent company for over 40 years, we are constantly looking at better, more advanced products that offer our customers a greater return on their investment.

We hold over £10m of farming and fencing stock in our eight nationwide branches and keep thousands of products available for quick and efficient delivery. Our bulk buying and storage policy leads to the significant savings we can offer no matter how big or small the project.

Our user-friendly website allows customers the freedom to choose purchasing goods online, direct from local branches or from Key Account Managers.

Innovation

As well as serving the needs of individuals, farmers, and contractors we have a proven track record delivering to major organisations such as the National Trust, Network Rail, RSPB, Natural England and the Environment Agency.

**Talk to us for the
best prices and
the best service**

Trade department more than just sales people

We have a dedicated team of Key Account Managers who specialise in servicing the trade, utility and commercial sectors. They are also available for on site advice, design and planning of your next project or budget management.

- Fence designs and specifications
- Latest advice on innovative products
- Livestock handling system design and supply
- Trade stockist rates available

- Livestock feed systems design and supply
- Treatment plant advice
- Latest grant information
- Dedicated key account manager

If you are looking for the **latest pioneering products** call us today

Key Account Managers: trade@mcveighparker.co.uk

Fencing

Quick Chapter Links



mcveighparker.com



Contemporary & traditional fencing options

Triple X Fencing

Tried, tested and guaranteed to last longer, our Triple X fencing kits consist of "the best performing trio" - X fence premium wire netting, Clipex® steel posts and Triple X Strainers. Kits are available in a variety of packages to suit your needs and budget.



Electric Fencing

We stock only the leading manufacturers in electric fencing such as Gallagher, Strainrite, Clipex® and our huge stock holding allows for the immediate dispatch of all of our electric fencing products.



Wire

Ideal for use in industrial, agricultural or domestic settings, wire fencing is a popular all-round fencing solution. Thanks to recent improvements in wire fencing technology, there is a much wider choice available today than there was ten or so years ago.

Garden Fencing

Updating, restoring, or replacing your garden fence? Our huge stock includes natural, rustic, and contemporary fences, also panel fencing kits to make the job easier. Our stock of soft landscaping options includes sleepers, path edging, and wattle hurdles for a more natural look.



Timber

Traditional wooden fencing is great for an inexpensive and aesthetically pleasing fencing solution as it is both attractive and functional. Perfect for paddock and roadside fencing, post and rail is an ideal choice for a cost-effective traditional fence.

Our fencing stock ranges from Clipex® fencing, famous for its ease of use and its longevity, to traditional timber fencing, electric fencing, wire and stock fencing as well as security and domestic fencing and gates.



Security Fencing

When you need to keep your land, property or business location safe, you'll need security fencing. For many years chain link and welded mesh have been the go to security fencing of choice which we stock. We also stock the modern mesh panel systems in various heights.



To view the complete McVeigh Parker fencing product range simply click the link to the right. ▶

Or use the following URL:
www.mcveighparker.com/fencing



Triple X Fencing

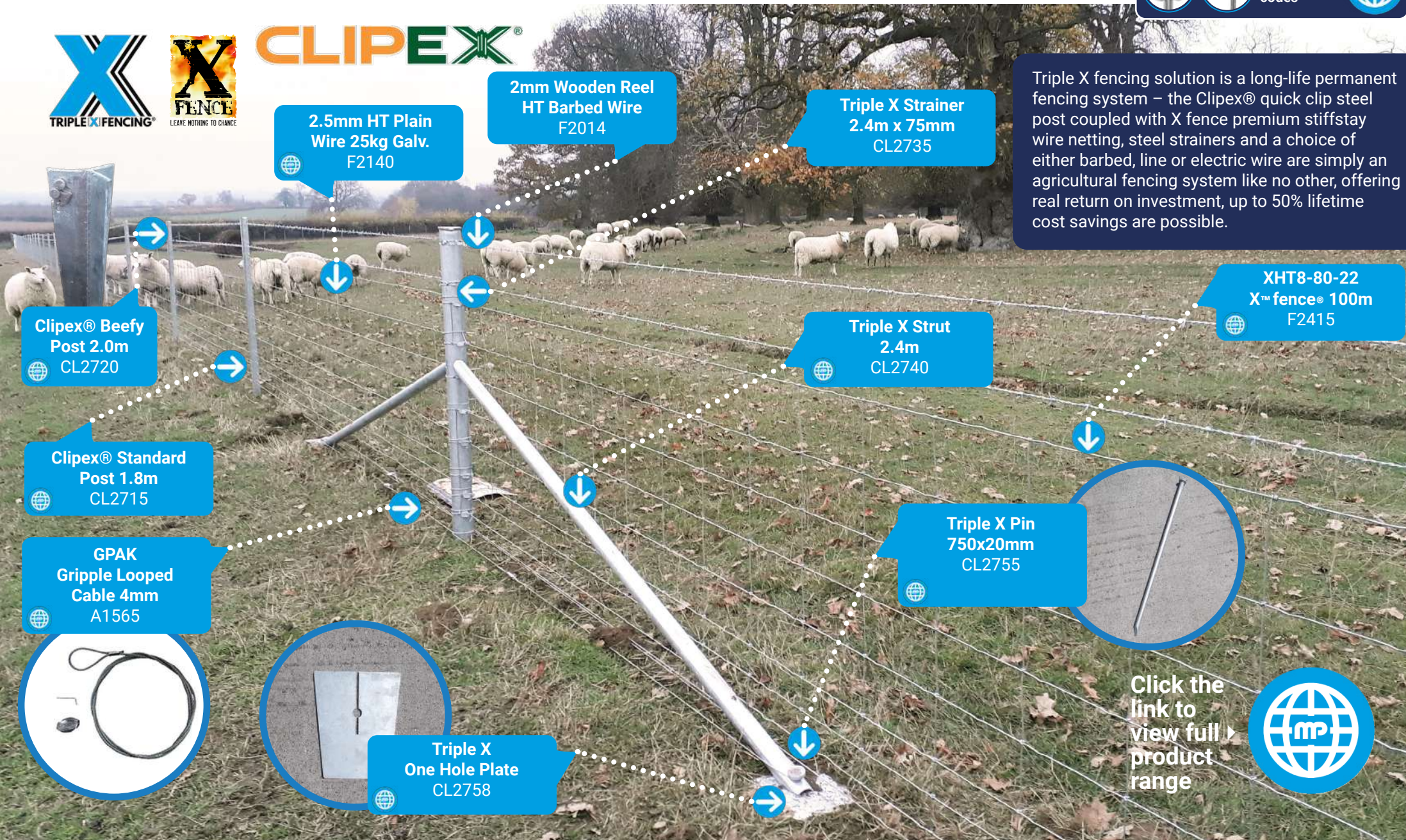

2.5mm HT Plain Wire 25kg Galv. F2140

2mm Wooden Reel HT Barbed Wire F2014

Triple X Strainer 2.4m x 75mm CL2735

Triple X fencing solution is a long-life permanent fencing system – the Clipex® quick clip steel post coupled with X fence premium stiffstay wire netting, steel strainers and a choice of either barbed, line or electric wire are simply an agricultural fencing system like no other, offering real return on investment, up to 50% lifetime cost savings are possible.

Clipex® Beefy Post 2.0m CL2720

Clipex® Standard Post 1.8m CL2715

GPAK Gripple Looped Cable 4mm A1565

Triple X Strut 2.4m CL2740

XHT8-80-22 X™ fence® 100m F2415

Triple X Pin 750x20mm CL2755



Triple X One Hole Plate CL2758

Click the link to view full product range



Triple X Lamb Friendly Stock Fence

Below, a technical drawing of a Triple X stock fence kit showing all the components and measurements needed to complete the project.

- 1.1m fence height
- Clipex® Standard posts 4.5m apart
- Clipex® Beefy every 5th post
- 2 lines of barbed wire (optional)
- Wire mesh has 22cm spacing between vertical wires

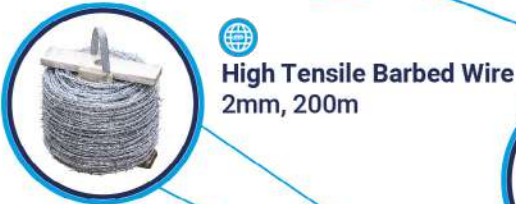
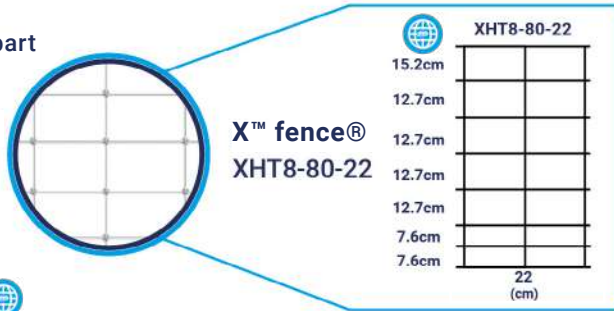

Triple X Corner/Two Way Strainer

4.5m intermediates

Triple X Diagonal End Strainer

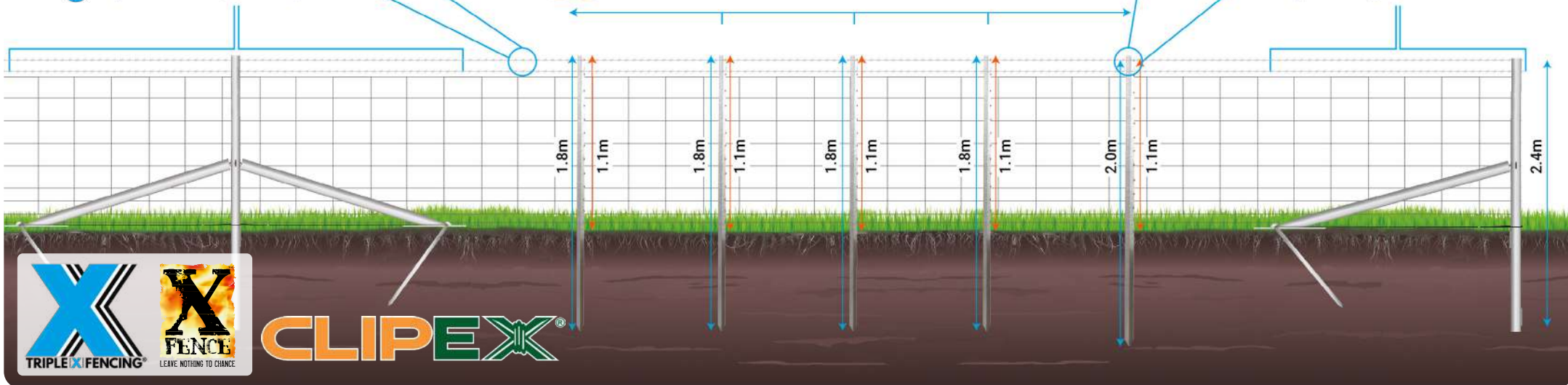

Have You Seen?

Our Triple X Deer Fence Kit

This kit contains all you need for 1000m of quality Triple X deer fencing, providing an overall fence height of 2.1m.

For further details see pages 16 and 17.

Triple X Brochure & Case Studies

Click link below.



Wire Fencing

A wide choice of stock netting, hexagonal wire netting, line wire and barbed wire, in different tensile strengths. For use in industrial, agricultural or domestic settings. We have a huge stock with over 50,000 rolls of fencing available. We can also design bespoke fencing.



Understanding the netting codes

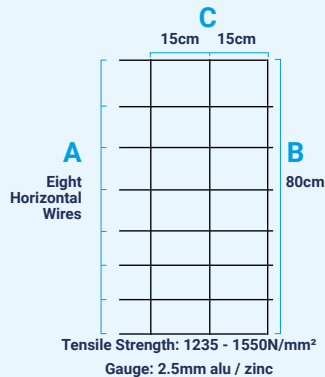

Tensile Strength

The strength of the wire, measured in N/mm² (Newton per square millimeter) in both horizontal and vertical axis.

X™ FENCE® 'THE ORIGINAL'

X fence fabricated fencing systems are world renowned for their durability and market leading quality. Using only the highest quality raw materials in their state-of-the-art production facility, X fence has been tried and proven in the harshest conditions and most testing applications worldwide.

- Stronger wire
- Premium coating
- Easier installation
- Longer maintenance free life



X Knot Joint



A wide variety of mesh patterns stocked to suit all livestock types.

What separates X™ fence® from the rest?

- X fence is the original X knot stiffstay product
- Only primary metal used, which means you get consistent tensile strength every time
- Every roll comes with 450mm pre-stripped ends, which make tying off easier and quicker
- Alu/zinc coated which gives 3-4 times longer life than standard galvanised products
- The alu/zinc coating also makes the wire more ductile, easier to work with and won't crack when tying off, which can happen with some heavy galvanised products

What do the product descriptions mean?

Fabricated netting codes. XHT8-80-15
 X = X Knot
 L = Light weight mild steel, hinge joint
 C = Medium weight, mild steel, hinge joint
 B = Heavy gauge, mild steel, hinge joint (very rarely used now)

LHT = Light high tensile
 HT = Heavy high tensile

XLHT = Light high tensile, X knot joint
 XHT = Heavy high tensile, X knot joint

8 = The amount of horizontal line wires
 80 = Height in centimetres
 15 = Distance between the vertical wires

Coating options to BSEN 10244-2

Xtralife alu/zinc coating.
 Lasts 2-3 times longer than galvanised coating.
 Highly recommended, exceeds British Standards.

Wire Joint Options



Hinged joint
 Traditional economical knot found in many types of fabricated net. Each vertical stay wire is separately wrapped at every horizontal line wire.

X Knot
 Proven to be one of the strongest knots in high tensile fabricated netting. The one piece vertical wires are held in place by a smooth surfaced forged X knot, creating an extremely strong almost self-supporting net



Tensile Strengths

	Horizontal Wires	Vertical Wires
L Mild =	600 - 800 mpa	400 - 600 mpa
C Mild =	600 - 800 mpa	400 - 600 mpa
LHT =	1100 - 1250 mpa	600 - 750 mpa
HT =	1048 - 1248 mpa	600 - 800 mpa
XLHT =	1235 - 1550 mpa	850 - 950 mpa
XHT =	1235 - 1550 mpa	850 - 950 mpa





- Manufactured from highest quality primary metals
- 95% zinc 5% aluminium
- XTRALIFE coating
- 24% stronger knot
- Smooth animal friendly abrasive free design forged X knot
- Tension curves absorb any pressure from climatic change or livestock pressure. Reduce by 50% for visible tensioning
- 450mm Pre-stripped ends, speeds up tying off time
- One piece uncut vertical wire
- Acts like its own intermediate, provides real strength & rigidity to the fence, almost self supporting
- Makes installation quicker
- XTRALIFE coating makes the wire more ductile, easier to work
- Resists cracking when tying off, unlike some heavy galvanised wire



Livestock Fencing



An unobtrusive smooth surface X knot greatly reduces the risk of fleece removal or hide damage, this is a very popular mesh pattern used widely in the UK and is ideal for most types of livestock. Manufactured to BS EN 10223-5, exceeds BS EN 10244 Class A, wire produced to BS 4102.



Full X™ fence® range stocked

PATTERN	TENSILE	KNOT	CODE	PATTERN	TENSILE	KNOT	CODE
XHT 8 - 80 - 15 Stock Fence	HT	X knot 100m	F2412 *	XHT 10 - 90 - 7.5 Horse	HT	X knot 100m	F2400
XHT 8 - 80 - 22 Lamb Fence	HT	X knot 100m	F2415 *	XHT 12 - 110 - 7.5 Horse	HT	X knot 100m	F2403
XHT 8 - 80 - 30 Stock Fence	HT	X knot 100m	F2416 *	XHT 13 - 125 - 7.5 Horse	HT	X knot 100m	F2406
XHT8 - 97 - 22 Cattle Fence	HT	X knot 100m	F2420 *	XHT 13 - 125 - 5 Foal/Horse	LHT	X knot 50m	F2408
XHT 11 - 122 - 15 Cattle/Railway	HT	X knot 100m	F2405	XHT 15 - 158 - 7.5 Badger	LHT	X knot 100m	F2411
XHT 11 - 122 - 7.5 Horse/Poultry	HT	X knot 100m	F24065	XHT 6 - 80 - 22 Game Bird Fence	HT	X knot 100m	F2424 *
XHT 13 - 190 - 15 Deer Fence	HT	X knot 100m	F2440 *	XHT 19 - 180 - 5 Security/Tree Guards	HT	X knot 50m	F2456
XLHT 13 - 190 - 15 Deer Fence (light)	LHT	X knot 100m	F2441	XLHT 19 - 180 - 5 Security/ Otter/ Dog/ Poultry	LHT	X knot 100m	F2457
XLHT 13 - 190 - 7.5 Poultry/ Dogs/Deer (light)	LHT	X knot 100m	F2448 *	XHT 17 - 190 - 7.5 Badger/Boar/Deer	HT	X knot 50m	F2454
XLHT 6 - 50 - 5 Apron Fence/Otter/ Poultry (light)	LHT	X knot 100m	F2427				

* Larger rolls, 200m, 300m & 500m also available on selected items.

Wire specification, coating and tensile strengths

TYPE	NOMINAL - HORIZONTAL WIRES	VERTICAL WIRES	COATING
XLHT - X Knot HT light	2.0mm - 1235/1550 (N/mm ²)	2.0mm - 850/950 (N/mm ²)	Alu/Zinc
XHT - X Knot HT Heavy	2.5mm - 1235/1550 (N/mm ²)	2.5mm - 850/950 (N/mm ²)	Alu/Zinc

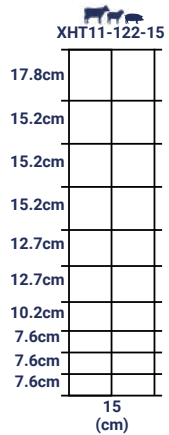
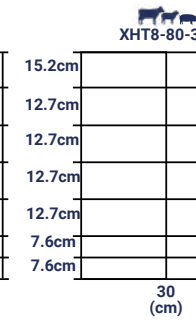
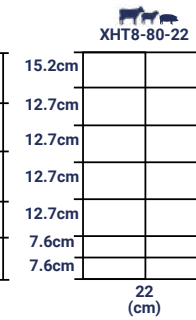

Specification	X™ fence®			Roll Lengths (m)	Code
	A (cm)	B (cm)	C (cm)		
XHT6-80-22 	6	80	22	100m	F2424
				300m	F2425
XHT8-80-15 	8	80	15	100m	F2412
				300m	F2414
XHT8-80-22 	8	80	22	100m	F2415
				300m	F2419
				500m	F2422
XHT8-80-30 	8	80	30	100m	F2416
				300m	F2418
				500m	F2417
XHT11-122-15 	11	122	15	100m	F2405

Our Advice

Looking for a sheep fence?

We recommend **XHT8-80-22**, this lamb friendly option has wider spacing between the vertical wires, this helps prevent lambs and sheep head entrapment also reduces tag loss.

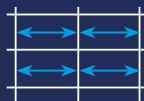

BS172-2 2020 now recognises this netting on welfare grounds.



Horse Fencing



The strong unobtrusive X knot not only provides an excellent joint, but its smooth surface also provides a safe environment for horses. The alu/zinc coating will last 3-4 times longer than galvanised wire. Five sizes to choose from, all with smaller mesh sizes, reducing the risk of injury or hoof entrapment.

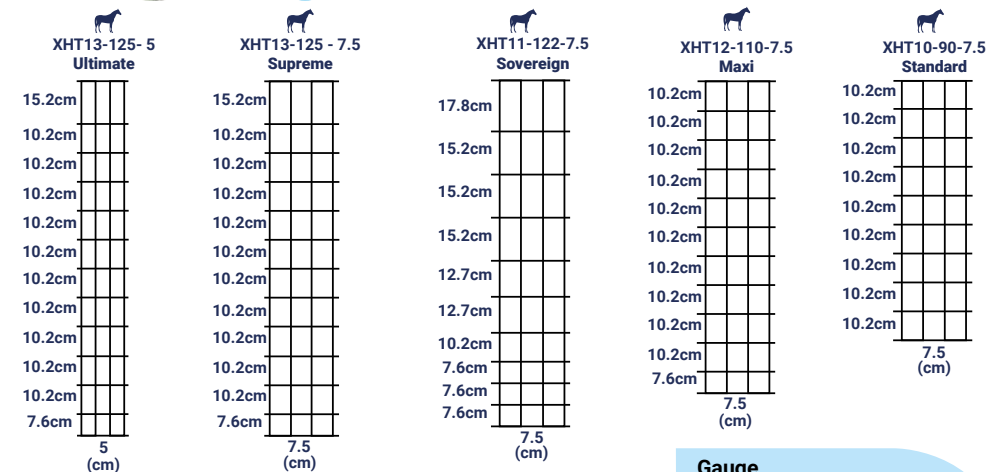

X™ fence®					
Specification	A	B	C	Roll Lengths	Code
	(cm)	(cm)	(cm)	(m)	
XHT10-90-7.5 Standard	10	90	7.5	50m	F2400
				100m	F2401
XHT12-110-7.5 Maxi	12	110	7.5	50m	F2402
				100m	F2403
XHT11-122-7.5 Sovereign	11	122	7.5	50m	F24062
				100m	F24065
XHT13-125-7.5 Supreme	13	125	7.5	50m	F2404
				100m	F2406
XHT13-125-5 Ultimate	13	125	5	50m	F2408

Gauge
2.5mm alu / zinc
Horizontal Tensile Strength
1235 - 1550 N/mm²
Vertical Tensile Strength
850 - 950 N/mm²

Our advice

XHT13-125-5 is the ultimate in horse fencing with its 50mm vertical wire spacing creating a narrow mesh pattern. X fence Ultimate is designed with safety in mind. The narrower mesh pattern makes it suitable for foals, reducing the risk of hoof entrapment



Deer Fencing

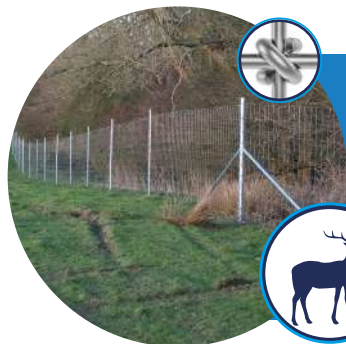

Deer fencing, when properly planned, constructed and maintained, can be an effective way of controlling deer populations and allows different land uses to coexist next to each other. It can also help to protect the public. If you need to contain use heavy gauge. If you wish to exclude you can use heavy or light gauge.

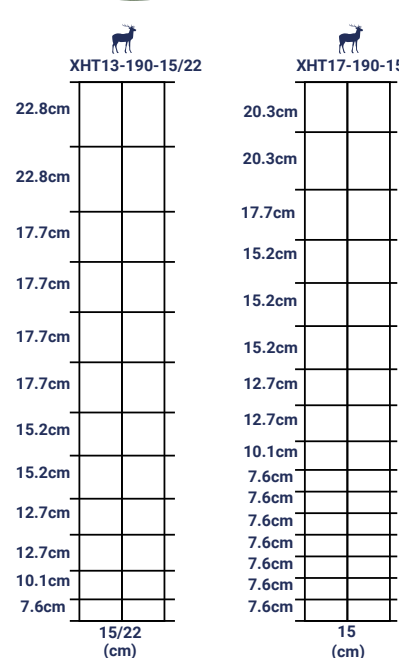

X™ fence®					
Specification	A	B	C	Roll Lengths	Code
	(cm)	(cm)	(cm)	(m)	
XLHT13-190-15 (Light)	13	190	15	100m	F2441
XHT13-190-15	13	190	15	100m	F2440
				200m	F2442
XHT13-190-22	13	190	15	200m	F2446
XHT17-190-15	17	190	15	100m	F2444
				200m	F2445

Gauge
2.5mm alu / zinc
Horizontal Tensile Strength
1235 - 1550 N/mm²
Vertical Tensile Strength
850 - 950 N/mm²

Did you know?

X fence knot has been proven to be 24% stronger than the other one piece alternatives.

Combining X fence and Clipex® together gives you a relocatable long-life product for woodland creation projects. Easier to transport and erect than timber.



Deer farmer Matt Smith Testimonial

Click ink to watch video



Triple X Deer Fence



Clipex® Beefy Post 3.0m
CL2730

High Tensile Wire 25kg Galvanised
F2140

Clipex® Deer Standard Post 3.0m
CL2725

XHT13-190-15 Deer X™ fence®
F2440

Triple X Strut 3m
CL2750

Triple X Strainer 3.3m
CL2745

Triple X Pin
CL2755

GPAK Grippler Looped Cable 4mm
A1570

Triple X Plate
CL2758

Triple X deer fencing. Various options available, contact us for a quote today.

Click link to view full product range



Have You Seen?

Our range of netting tools and clip options.

Check them out in the tools and fixings section of this brochure or go to mcveighparker.com and order the required items from there.

Badger Fencing



The X knot badger fencing has been designed to withstand the aggressive nature of badgers. Once the base is buried underground, the fence will exclude badgers. We advise that badger fencing should be at least 1250mm high, buried a minimum 450mm into the ground and then angled for 200mm in the direction a badger would approach.

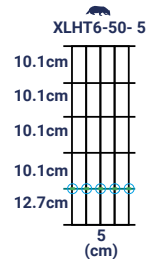
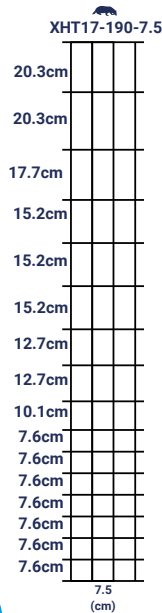
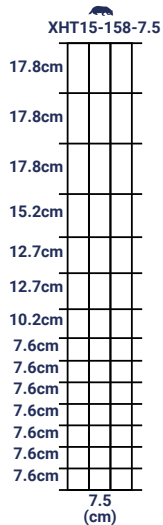

Can be buried vertically, slightly folded out or used in conjunction with apron net XHT6-50-5 (F2428)

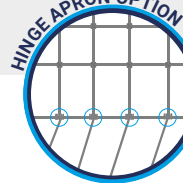

X™ fence®					
Specification	A	B	C	Roll Lengths	Code
	(cm)	(cm)	(cm)	(m)	
XHT15-158-7.5	15	158	7.5	50m 100m	F2410 F2411
XHT17-190-7.5	17	190	7.5	50m	F2454
XLHT6-50-5 Light (Apron)	6	50	5	100m (Hinged)	F2428

Gauge
2.5mm alu / zinc
Horizontal Tensile Strength
1235 - 1550 N/mm²
Vertical Tensile Strength
850 -950 N/mm²

Did You Know?

We also sell J & U pins for securing a wide range of applications.

We also sell badger gates, for more details see our badger fence spec sheet online.



Strength of badger fencing

Click link to watch video



Otter Fencing



This predator fencing is designed to protect inland fisheries and facilitate highway exclusion. This high spec fence is particularly suitable for the commercial and government sectors. Shorter heights and lighter gauges, coupled with electric fencing can be very cost effective.

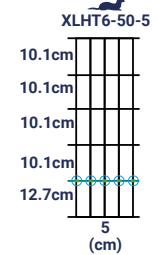
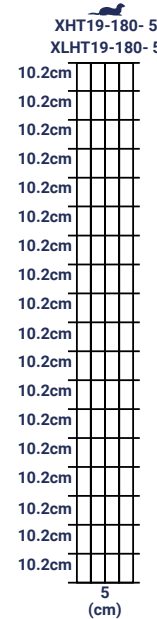

Can be buried vertically, slightly folded out or used in conjunction with apron net XHT6-50-5 (F2428)



Gauge
2.0mm alu / zinc coated high tensile wire throughout.

McVeigh Parker are able to manufacture bespoke sizes and a site visit can be arranged if required. (Min. 2000m)

X™ fence®					
Specification	A	B	C	Roll Lengths	Code
	(cm)	(cm)	(cm)	(m)	
XLHT19-180-5 Light	19	180	5	50m (hinged)	F2460
XHT19-180-5 Heavy	19	180	5	50m	F2456
XLHT6-50-5 Light (Apron)	6	50	5	100m (hinged)	F2428
XLHT23-240-5 Light	23	240	5	50m (hinged)	F2463 Special
XLHT26-180-5 Light	26	180	5	50m	F2465 Special

Otter fencing
There are many options for otter fencing - different heights, gauges, one piece, two piece. Our recommendation is to erect a heavy one piece vertical netting, buried, then clip an apron netting above and/or below should there be a need. This will not only make erection easier, the heavier wire will provide a longer, stronger life.



Otter Vs X fence

Click link to watch video



Poultry Fencing



The tensile strength of X fence netting, along with the one-piece vertical wires which almost act as their own intermediate posts, allow posts to be spaced further apart. The X knot joint has been proved to be 24% stronger than similar stiffstay knots. The alu/zinc coating will last three to four times longer. All this combines to make a premium fabricated wire netting that is an effective barrier against predators.

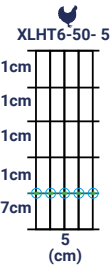
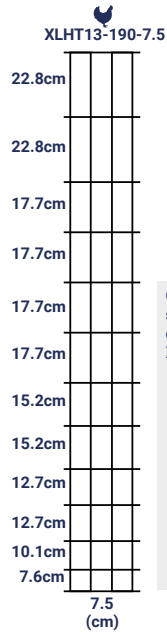

Can be buried vertically, slightly folded out or used in conjunction with apron net XHT6-50-5 (F2428)

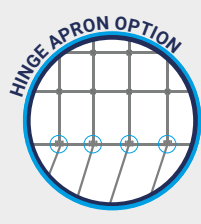

The largest free range poultry producer in Southern England was looking to reduce their annual fence maintenance costs and create a secure fence for their farms. The farm manager used his past experience to design an X fence netting pattern that he was confident would exclude predators. The Triple X system was chosen coupled with XHT26-240-5 hinged X fence and cranks.

Read full case study online <https://mcveighparker.com/blog/clipex-chicken-farm/>



See how a free range poultry unit used high tensile hinge jointed poultry netting coupled with Clipex® deer and pasture posts to form a protective enclosure.



Click link to watch video ▲

Special netting made to order.

Contact us for further details.

X™ fence®					
Specification	A	B	C	Roll Lengths	Code
	(cm)	(cm)	(cm)	(m)	
XLHT13-190-7.5 	13	190	7.5	100m Light	F2448
XHT15-158-7.5	15	158	7.5	100m Heavy	F2411

Gauge

2.5mm alu / zinc

Horizontal Tensile Strength

1235 - 1550 N/mm²

Vertical Tensile Strength

850 -950 N/mm²

Dog Fencing (X Knot)



Whether you are looking to secure your garden or create a commercial dog walking and exercise area, Dog X fence gives you a long lasting, fully secure enclosure. The one piece vertical wire means less intermediate stakes required, plus you get all the premium advantages of X fence. Combining Clipex® galvanised steel fence posts with X fence premium wire netting you have a fence that's easy to install and maintain and guaranteed for 30 years, this is the choice of the professionals.

Why not view our case study online?
www.mcveighparker.com/dog-fencing



Features

- Suitable for: Dog
- 50m or 100m roll options
- Compatible with Clipex® posts:
 - Yes - Clipex® Deer posts
- Overall Height: 190cm / 1900mm
- No. of line wires: 13
- Distance between vertical wires: 7.5cm / 75mm
- Distance between horizontal wires: See mesh pattern to the right
- Wire gauge: 2.5mm alu/zinc coated high tensile wire throughout
- Horizontal wires tensile strength: 1235/1550 N/mm²
- Vertical wires tensile strength: 850/950 N/mm²
- Knot type: X knot
- Manufactured to BS EN 10223-5
- Exceeds BS EN 10244 Class A
- Wire produced to BS 4102

Gauge

2.5mm alu / zinc

Horizontal Tensile Strength

1235 - 1550 N/mm²

Vertical Tensile Strength

850 -950 N/mm²

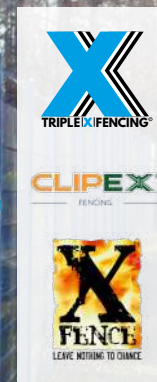
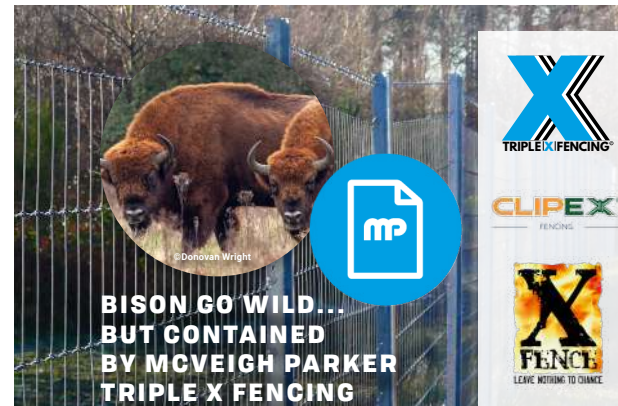
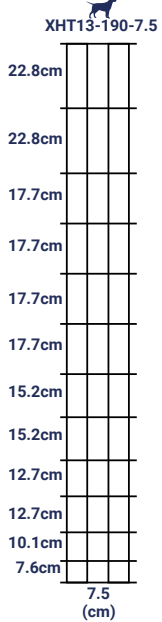

Have You Seen Our Testimonials?

McVeigh Parker is involved with some exciting projects, organisations and individuals.

Check out our testimonials and case studies on our media page.

www.mcveighparker.com/our-media

Livestock Fencing (Hinge Jointed)



Cost-effective durable fencing available in light and medium mild wire, as well as light and heavy high tensile options. Hinge joint netting comes in various mesh sizes and patterns to suit specific applications. All our hinge jointed wire netting is manufactured to BS EN 10223-5, all wires used are manufactured to BS4102. Galvanised to BS EN 10244-2 Class A.

Mild Tensile Hinge Joint

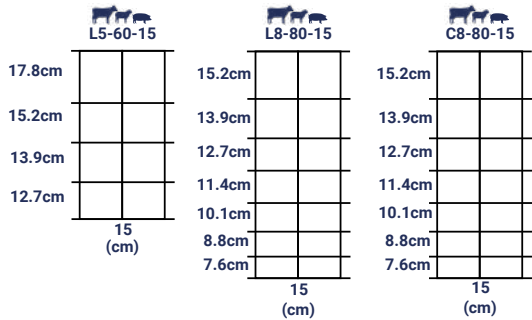

Light High Tensile Hinge Joint

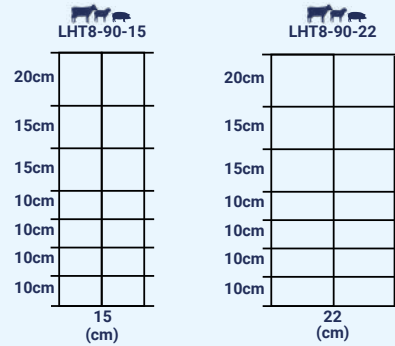

High Tensile Hinge Joint

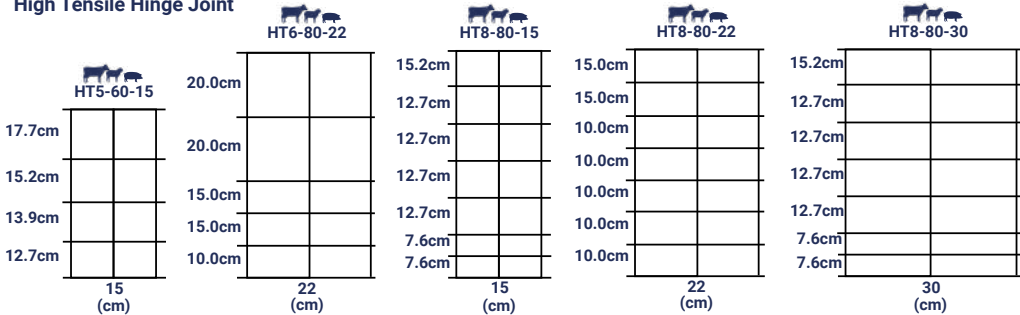

Mild Tensile Hinge Joint					
Specification	A	B	C	Roll Lengths	Code
	(cm)	(cm)	(cm)	(m)	
L5-60-15 (Light)	5	60	15	50m	F2220
C8-80-15	8	80	15	50m	F2210
				100m	F2298 *
L8-80-15 (Light)	8	80	15	50m	F2200
				100m	F2205

High Tensile Hinge Joint					
Specification	A	B	C	Roll Lengths	Code
	(cm)	(cm)	(cm)	(m)	
HT5-60-15	5	60	15	100m	F2329
HT6-80-22	6	80	22	100m	F2335
HT8-80-15	8	80	15	100m	F2311 *
				300m	F2310
HT8-80-22	8	80	22	100m	F2318
HT8-80-30	8	80	30	100m	F2320
LHT8-90-15	8	90	15	100m	F2336
LHT8-90-22	8	90	22	100m	F2323

* Most popular & best value.

Dog Fencing (Hinge Jointed)

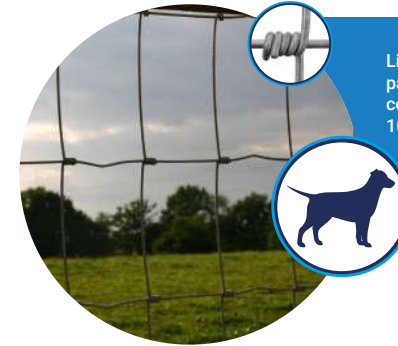

Lightweight and easily worked. The added height and smaller mesh pattern make it suitable for garden fencing, alpacas, and is ideal for dog containment. Manufactured from hot-dipped galvanised wire, to BS EN 10223. Heavy galvanised 245gsm BS EN 10244-2 Class A

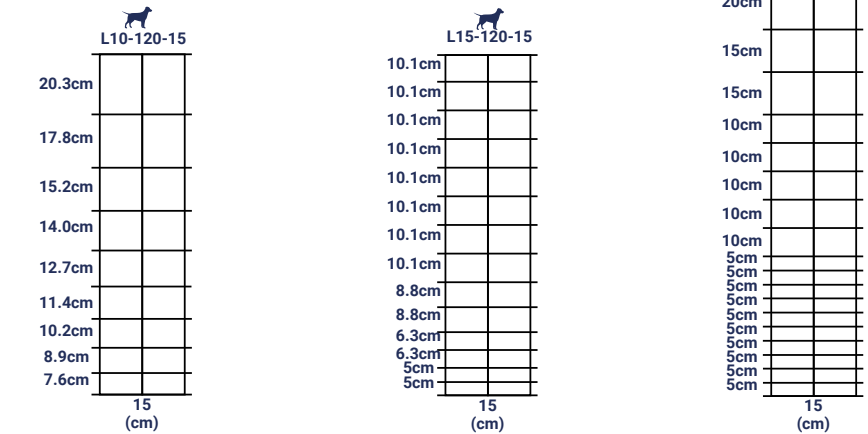

Mild Hinge Joint					
Specification	A	B	C	Roll Lengths	Code
	(cm)	(cm)	(cm)	(m)	
L10-120-15	10	120	15	50m	F2240
L15-120-15	15	120	15	50m	F2235
L19-150-15	19	150	15	50m	F2231

Gauge
2.5mm alu / zinc (top & bottom)
1.9mm (infills)
Horizontal Tensile Strength
600 - 800 N/mm²
Vertical Tensile Strength
400 - 600 N/mm²

See Also...

Our Triple X dog fence on page 21.



A Helpful Hint...

X fence stock fence is a premium wire netting that will give a very good return on investment. The one piece vertical wire allows you to space intermediate stakes up to 5m apart. Fewer stakes mean less labour which leads to overall savings. See page 11 for more details.



Deer Fencing (Hinge Jointed)



Understand the netting codes

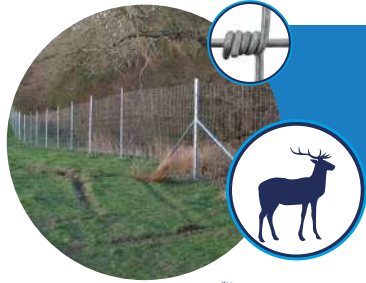

Deer fencing, when properly planned, constructed and maintained, can be an effective way of controlling deer populations and allows different land uses to coexist next to each other. It can also help to protect the public. If you need to contain use heavy gauge. If you wish to exclude you can use heavy or light gauge.

HT13-190-15

22.8cm	
22.8cm	
17.7cm	
17.7cm	
17.7cm	
17.7cm	
15.2cm	
15.2cm	
12.7cm	
12.7cm	
10.1cm	
7.6cm	
15 (cm)	

High Tensile Hinge Joint					
Specification	A	B	C	Roll Lengths	Code
		(cm)	(cm)	(m)	
LHT13-190-15 (Light)	13	190	15	50m	F2353
				100m	F2355
HT13-190-15	13	190	15	100m	F2395

Hinge Jointed Deer Netting is a more cost effective exclusion fence.

For containment we advise using X fence



Why Alu/Zinc coating?

Alu/Zinc coating simply lasts longer than galvanised coating, especially important in high corrosive areas. The average atmospheric zinc corrosion rates across the UK and Ireland are normally less than 1µm (Micron), per year, a typical 70µm coating can provide over 70 years of maintenance-free life. The British Standard BSEN 1461 coating lists a sacrificial galvanised zinc coat of 325 g/m2, (avg 45microns). X fence exceeds these standards.

To check out the corrosive rate of your location log onto this link

www.galvanizing.org.uk/corrosion-map/

MP wire and posts unless otherwise stated conform or exceed BSEN 1461.T

Heavy Gauge

2.5mm throughout

Light Gauge

2.5mm top and bottom
2.0mm infills

Horizontal Tensile Strength

1048 -1248 N/mm²

Vertical Tensile Strength

600 - 800 N/mm²

Coating

XTREME Alu/Zinc coating, exceeds BSEN 10244-2 lasts 3-4 times longer than galv

Features XTREME alu/zinc reinforced coating.

Plastic Deer / Pheasant Netting

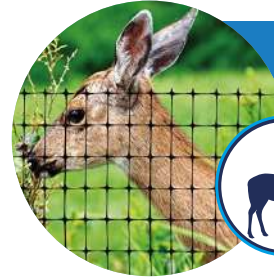

High tensile strength tough yet lightweight unobtrusive extruded plastic netting. An effective yet economical exclusion barrier, the perfect solution for an immediate and quick deer protection.

HD UV-Protected Polypropylene Low-Visibility Deer Net Fencing

Reinforced top edge



This black netting creates an unobtrusive barrier, blending into the background, making it ideal for gardens. Lightweight, UV stabilised, rot proof and easy to install. This particular mesh and 1.8m fence height are designed to exclude Muntjac, Sika and Roe deer, although Fallow deer will be deterred we recommend a higher plastic or ideally a permanent galvanised wire netting fence for total exclusion.

Erection : McVeigh Parker have a full range of posts and accessories to help with your install. The netting can simply be cable tied to line wires, battened to timber posts or used with Clipex® steel posts and line wire system for a fully moveable long lasting fence system.



Netting Type	Dimensions	Code
Deer & Pheasant Net	1.8m x 100m - 50mm x 50mm	NET250
Deer & Pheasant Net	1.2m x 100m - 50mm x 50mm	NET251

For those looking for a smaller mesh for better protection from birds etc, we recommend below. Not suitable for deer exclusion

Netting Type	Dimensions	Code
Bird exclusion/ fruit protection netting	1.8m x 100m 19mm x 19mm	NET235
Bird exclusion/ fruit protection netting	1.2m x 100m 19mm x 19mm	NET220

Suitable for many other applications. Such as pheasant pens, fruit protection, vegetable and shrub protection, pool/pond netting.



CLIPEX® Posts

Clipex® the multi award winning innovative permanent quick clip galvanised steel posts. Clipex® posts are STRONGER, FASTER, and EASIER to install. They are more secure and need less maintenance. Each post holds the wire firmly in place with a spring-loaded clip, which means no fiddly parts to lose or fit.

These clips allow lateral flex but very little vertical wire movement is possible, which is important when downward pressure is put on the fence line. Every post has a pre-fixed anti-lift plate below ground level to prevent lifting in soft or undulating ground. Clipex® posts come in two profiles and five lengths to suit many applications.



Clipex® Standard Post
1.8m - CL2715



Clipex® Beefy Post
2.0m - CL2720



Suggested netting for posts: **XHT8-80-15 F2412**



Clipex® Railway/Cattle Standard Post
2.0m - CLR2710



Clipex® Railway/Cattle Beefy Post
2.1m - CLR2720



Suggested netting for posts: **XHT11-122-15 F2405**

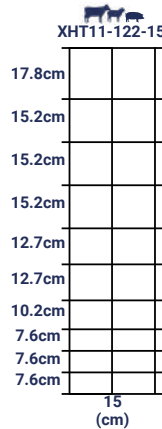

Please note that if to be used as a cattle or horse fence we highly recommend using either Clipex Beefy posts which will stand the stock pressure or an electric top line to avoid any pressure on the fence. All posts are hot dip galvanised and independently tested in the U.K. they exceed British industry standards. Each post holds the wire firmly in place with a spring-loaded clip, which means no fiddly parts to lose or fit. These clips allow lateral flex but very little vertical wire movement is possible, which is important when downward pressure is put on the fence line.

Every post has a pre-fixed anti-lift plate below ground level to prevent lifting in soft or undulating ground. Clipex® posts come in two profiles and five lengths to suit many applications. Please note that if to be used as a cattle or horse fence we highly recommend using either Clipex Beefy posts which will stand the stock pressure or an electric top line to avoid any pressure on the fence. All posts are hot dip galvanised and independently tested in the U.K. they exceed British industry standards.



Clipex® Deer Standard Post
3.0m - CL2725



Clipex® Deer Beefy Post
3.0m - CL2730



Suggested netting for posts: **XHT13-190-15 F2440**

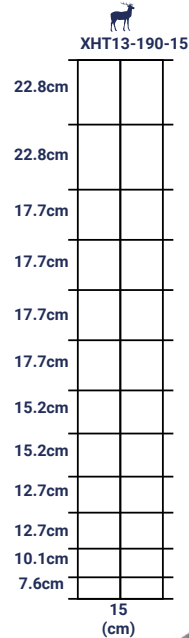

Clipex® Eco Post
1.8m - CL2710



Suggested netting for posts: **HT8-80-15 F2311**

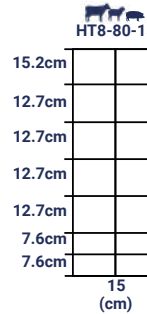

TO VIEW COMPLETE **CLIPEX®** POST RANGE **CLICK THE LINK**



Clipex® Pasture Post
1.5m - CL2705

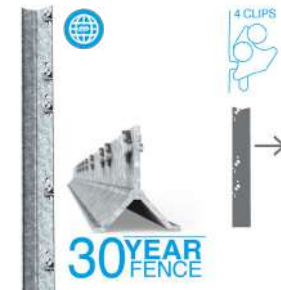

Clipex® Beefy Pasture Post
1.5m - CL2708



Clipex® Standard Rock Post
1.4m - CL2716

Suggested wire for posts: **3.15 HT Plain Wire F2145**



Line Wire



High Tensile XTRALIFE Alu/Zinc Coated

Gauge	Approx. Length	Code
2.50mm	651m	F2142
3.15mm	410m	F2147

- Tensile strength : 1250 -1350 (N/mm2)
- Coating weight : min 240g/m2
- Wire diameter tolerance : +/-0.04(mm)
- Coil ID / Coil OD : 570 mm / 730 mm approx.
- Alu/Zinc coating which exceeds BSEN 10244-2 Class A

High Tensile Line Wire

Gauge	Approx. Length	Code
2.00mm	1017m	F2104
2.50mm	651m	F2140
3.15mm	410m	F2145
4.00mm	254m	F2150

- Specifications as above
- Heavily galvanised to BSEN 10244-2 Class A

Mild Line Wire

Gauge	Approx. Length	Code
1.89mm	1190m	F2102
2.50mm	651m	F2115
3.15mm	410m	F2120
4.00mm	254m	F2125

- Tensile strength : 350 -550 (N/mm2)
- Coating weight : min 240g/m2
- Wire diameter tolerance : +/-0.04(mm)
- Coil ID / Coil OD : 570 mm / 730 mm approx
- Heavily galvanised to BSEN 10244-2 Class A

Tying Wire



- Flexible, easy to work with
- Galvanised for long life protection
- Approximately 100m
- Protected against corrosion
- Hot-dip galvanised with added layer of green plastic
- Approximately 100m

Wire	Gauge	Coil Length	Code
Galvanised	1.60mm	100m	CL4219
PVC	1.60mm/2.50mm	100m	CL4220

The Reel Wire - Bobbins



- Tensile strength : 1235 -1390 (N/mm2)
- Coating weight : min 240g/m2
- Wire diameter tolerance : +/-0.04(mm)
- Heavily galvanised to BSEN 10244-2 Class A

Gauge	Coil Length	Code
2.50mm	600m	F2141
3.15mm	400m	F2144

Aviary Mesh



- Ideal solution for bird, rabbit and rodent enclosures
- Also suitable for domestic and farm fencing of small mammals
- Stronger than traditional hexagonal mesh
- Hot-dip galvanised for longer life

Mesh	Gauge	Height	Code
13x13mm	1.0mm	900mm	F9300
		1200mm	F9338
25x13mm	1.0mm	900mm	F9325
	1.6mm	900mm	F9309
25x25mm	1.0mm	900mm	F9320
	1.6mm	900mm	F9310
		1200mm	F9340
		1800mm	F9345
	2.00mm	900mm	F9308

Barbed Wire



High Tensile Alu/Zinc

- 2.0mm wire gauge
- Manufactured to BSEN 10223-1
- Alu/Zinc coating exceeds to BSEN 10244-2 Class A

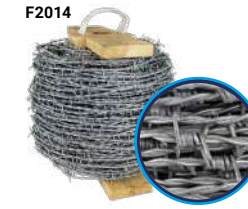

High Tensile Galvanised

- 2.0mm wire gauge
- Manufactured to BSEN 10223-1
- Galvanised to BSEN 10244-2 Class A



High Tensile BLACKMAX Bezinal

- 2.0mm wire gauge
- Manufactured to BSEN 10223-1
- Exceeds BSEN 10244-2 Class A

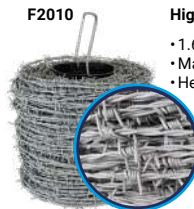

High Tensile Light

- 1.6mm wire gauge
- Manufactured to BS EN 10223-1
- Heavily galvanised to BSEN 10244-2



Mild Steel

- 2.5mm wire gauge
- Manufactured to BS EN 10223-1
- Heavily galvanised to BSEN 10244-2

Barb Wire Type	Line wire dia & Tensile Strength	Barb dia & Tensile Strength	Length	Code
Alu/Zinc	2.0mm dia - 1050-1250 N/mm ²	1.9mm dia - 440-540 N/mm ²	200m	F2015
Heavy Galvanised	2.0mm dia - 1050-1250 N/mm ²	1.9mm dia - 440-540 N/mm ²	200m	F2014
* Bezinal Black Tipped	2.0mm dia - 1050-1250 N/mm ²	1.9mm dia - 440-540 N/mm ²	500m	F2013
High Tensile Light	1.6mm dia - 1050-1200 N/mm ²	1.45mm dia - 415-495 N/mm ²	200m	F2010
Galvanised Mild Steel	2.5mm dia - 415-495 N/mm ²	2.0mm dia - 415-495 N/mm ²	200m	F2000

* Black Benzinal Barbs, why?

They are three times more resistant to rust due to its unique outer black Benzinal coated barbs, as the barbs come into livestock contact they are better treated for a longer life.

Concertina Barbed Wire Tape F2021



"Protect your premises, instantly"

Razor wire is effective as a secondary line of defence, widely used by many businesses to prevent unauthorised access.

- Outer Dia. coil 450mm (18")
- Length/Coil : 10m
- Wire Dia. 2.5mm
- Razor Centre Distance 35mm
- Razor Thickness : 0.5mm
- Razor Length : 20mm



The property owner needs to ensure the use of barbed tape does not infringe criminal or civil law

Hexagonal Wire



Hexagonal wire, also known as hexagonal mesh, Chicken or Rabbit wire, is a versatile and widely-used fencing material with a characteristic hexagonal pattern. It is made from galvanized steel wire, creating a flexible and durable mesh. This type of wire has a wide range of applications due to its unique properties and benefits.

Some of the primary uses of hexagonal wire:

- 1. Garden Fencing:** Hexagonal wire is commonly used in gardening and landscaping to create protective enclosures for gardens, flowerbeds, and vegetable patches.
- 2. Rabbit Fencing:** Farmers use hexagonal wire to protect crops, often burying to prevent digging, heavier gauge netting is recommended.
- 3. Poultry and Pheasant Enclosures:** Hexagonal wire is widely used in poultry and pheasant enclosures, either one piece or more common is a smaller mesh half way with a larger mesh top net, providing a height of over 1.8m.
- 4. Small Animal Cages and Enclosures:** Hexagonal wire is used to build cages and enclosures for small pets like rabbits, guinea pigs, and birds. The wire mesh offers a safe and well-ventilated living space for these animals.
- 5. Tree Guards:** Hexagonal wire is used to protect young saplings from rabbits and deer.
- 6. Bird Protection:** Hexagonal wire with a finer mesh is utilized as eave protection, preventing birds, squirrels from entering gaps and vents.
- 7. Decorative Applications:** Beyond practical uses, hexagonal wire is sometimes utilized for decorative purposes. It can be incorporated into artistic installations, sculptures, and garden features to add an intriguing and unique aesthetic.

Overall, hexagonal wire's versatility, durability, and relatively low cost makes it a popular choice for a wide range of applications, from agricultural and gardening needs to civil engineering projects and creative endeavours.

McVeigh Parker stock two types

Fortress Super 6 – Is our premium hexagonal super 6 netting offering exceptional durability and versatility. Unlike light galvanized netting, this super 6 hexagonal wire boasts an impressive six times longer lifespan. Hot dip galvanized after manufacture gives it great corrosive resistance. If you are looking for the best longest lasting hexagonal netting then super 6 should be your wire of choice, giving far greater return on your investment.

Fortress Value – Is our competitively priced range of hexagonal wire netting suitable for many projects, ideal for those working on a tight budget prioritizing cost-effectiveness and affordability over long term durability.

Rabbit Hexagonal Wire

LASTS UP TO 6X LONGER THAN LIGHT GALVANISED WIRE

- 50m rolls
- Tensile strength 350-450 N/mm²
- Heavy galvanized to BS EN 10224-2
- Hot dip galvanized after manufacture



Height	Mesh	Gauge	Application	Code
1050mm	31mm	1.2mm (18g)		F1G3230
1200mm	31mm	1.2mm (18g)		F1G3250

Best return on investment

- 50m rolls
- Tensile strength 350-450 N/mm²
- Pre-galvanized finish



* Most popular

Height	Mesh	Gauge	Application	Code
600mm	31mm	1.0mm (19g)		F1C3200
1050mm	31mm	1.0mm (19g)		F1C3221
1050mm	31mm	1.2mm (18g)		F1C3230
1200mm	31mm	1.0mm (19g)		F1C3241
1200mm	31mm	1.2mm (18g)		F1C3250
1500mm	31mm	1.0mm (19g)		F1C3255
1800mm	31mm	1.0mm (19g)		F1C3260
1800mm	31mm	1.2mm (18g)		F1C3265

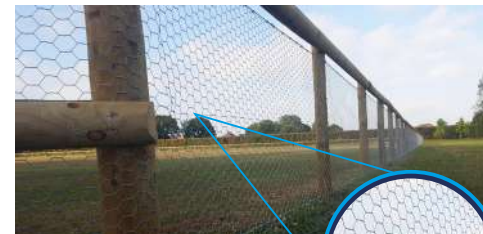

Reinforced Horizontal Wire



Other Hexagonal Wire



- 50m rolls
- Tensile strength 350-450 N/mm²
- Pre-galvanized finish



Height	Mesh	Gauge	Application	Code
900mm	13mm	0.9mm (20g)		F1C3025
1200mm	13mm	0.9mm (20g)		F1C3040
600mm	19mm	1.0mm (19g)		F1C3054
900mm	19mm	0.9mm (20g)		F1C3055
900mm	25mm	1.0mm (19g)		F1C3170
900mm	25mm	1.2mm (18g)		F1C3165
1200mm	25mm	1.0mm (19g)		F1C3140
1200mm	25mm	1.2mm (18g)		F1C3175
1800mm	25mm	1.0mm (19g)		F1C3190
900mm	50mm	1.0mm (19g)		F1C3370
1200mm	50mm	1.0mm (19g)		F1C3380
1800mm	50mm	1.0mm (19g)		F1C3400

Sizes and gauges are meant as a guide, comparable to market standards and tolerances.

Did you know?



We also stock and supply line wire, netting pliers, clips and fixings, timber or steel posts. Combining hexagonal wire with Clipex® steel posts will give you a fast, easy to erect fence. Using Clipex® steel posts for poultry or pheasant pens allows you to relocate the pens easily, should you wish to provide fresh foraging areas and maintain a healthy environment for your birds.

Fresh ground reduces the build-up of faeces and waste, which can help prevent the spread of diseases and parasites. Plus the posts are recyclable at the end of their life.



Security Fencing

Keep your land, property or business safe with our security fencing. We stock a wide range, so whether your application is industrial, commercial or agricultural, we will have a security fencing system suitable for your requirements. Palisade, Meshed Panels, Chain Link and Welded Mesh are all available.

Meshed Panels

VMEX V3 Mesh Panels

Features

- Compliant to BS 1722 pt.14
- M8 security fixings
- Top flat section of panel allows easier stepping of mesh
- Standard colours Green RAL 6005 + Black RAL9005
- Polyester Powder Coated to a choice of colours
- Height - 1200mm, 1800mm, 2000mm, 2400mm, 3000mm
- Wire Diameter - 4mm verticals & 5mm horizontals

Suitable for:

- Commercial Development
- New Build Housing
- Hospitals

Cost effective perimeter fence



ZEBEX Z3 Mesh Panels

Features

- Compliant to BS 1722 pt.14
- M8 security fixings
- Choice of colours available
- Height - 1800mm
- Wire Diameter - 4mm verticals & 4mm horizontals

Suitable for:

- Commercial Business
- Recreation Areas
- Hospitals
- Airports
- Multi Storey Car Parks

Most popular perimeter fence



Duex Mesh Panels

Features

- Compliant to BS 1722 pt.14
- M8 security fixings
- Rigid double wire design
- Polyester Powder Coated to a choice of colours
- Heights - 1230mm, 1830mm, 2030mm, 2430mm, 3030mm
- Wire Diameter - 6mm verticals & twin 8mm horizontals

Suitable for:

- Schools, Colleges & Universities
- Commercial Premises
- Industrial Units
- Theme Parks

Also available as 868 rebound fencing. Ideal for sports grounds and zoo's



Bow Top Railings



Features

- Compliant with BS 1722 Pt. 9
- Security Fixings
- Stepping Cleats
- Welded Construction
- Hot Dip Galvanised to BS EN ISO 1461
- Polyester Powder Coated option
- Various Designs Available

Suitable for:

- Recreation Areas
- Schools
- New Build Housing

Steel Palisade



Features

- Hot Dip Galvanised
- Sturdy And Secure Fencing Solution
- Components Supplied Loose For Easy On-Site Construction
- W Profile, Triple Point
- Available In Various Profiles, Gauges And Finishes

Suitable for:

- MOD
- Police Stations
- Secure Units
- Airports
- Hospitals
- Schools
- Utility Suppliers

358 Mesh



Features

- Compliant With BS 1722 Pt. 14
- Security Fixings
- Anti-Climb Fence
- Panel Heights Available Up To 5.2m
- Polyester Powder Coated
- Suitable For Many Applications
- Narrow Apertures Very Secure

Suitable for:

- MOD
- Police Stations
- Secure Units
- Airports
- Hospitals
- Schools
- Utility Suppliers

Vertical Bar Railings



Features

- Compliant with BS 1722 Pt. 9
- Security Fixings
- Stepping Cleats
- Welded Construction
- Hot Dip Galvanised to BS EN ISO 1461
- Polyester Powder Coated Option
- Various Designs Available

Suitable for:

- Perimeter Fencing
- Retail Outlets
- Commercial Business
- New Build Housing

STRENGTH AND SECURITY

Suitable for use in fixing all types of wooden, metal and concrete posts

Kiln dried, pre-blended, factory-produced quick setting concrete

Hardens in approximately 10 minutes after water addition, depending on ambient conditions



Special rates on pallet, half load, full load rates, contact us

Chain Link

Chain Link Galvanised



- Galvanised mild steel woven and galvanised to BSEN10244-2.
- Manufactured to BSEN1722-1 2006.

Green PVC Chain Link



- Green PVC coated finish RAL6055
- Manufactured with Galvanised Grade 2 Core Wire
- Rolls come complete with 52m green linewire (900 & 1200mm)
- 78m green linewire (1400 & 1800mm)

High Tensile Chain Link



Commonly known as Super 70 or Dragon HT is over twice the strength of traditional chain link, it has a smaller mesh pattern for greater security and rigidity.

Most commonly used on railways.

Gauge	Mesh	Length	Height	Code
2.50mm (Standard)	50mm	25m	900mm	CL1100
			1200mm	CL1105
			1800mm	CL1120
			2400mm	CL1165
3.0mm (Heavy)	50mm	25m	900mm	CL1130
			1200mm	CL1135
		12.5m	1800mm	CL1150
			2400mm	CL1165

Gauge	Length	Mesh	Height	Code
2.24/ 3.15mm	12.5m	50mm	2400mm	CL1250
			900mm	CL1225
	1200mm		CL1230	
	1400mm		CL1235	
25m	1800mm	CL1245		

Gauge	Length	Mesh	Height	Code
3.0mm	12.5m	40mm	1.4m	CL1215
			1.8m	CL1220
		12.5m		

Coated with zinc, aluminium, magnesium with a green anti-corrosion barrier giving enhanced protection which lasts five times longer than heavily galvanised wire to BS EN 10244-2 class A

Welded Mesh

Welded Mesh Galvanised



- Self-supporting, strong long lasting netting
- Ideal for numerous uses, security fencing
- Dog compounds, poultry pens & tree guards
- Electro welded uniformed mesh pattern joints
- Heavily galvanised coating to BS 443

Gauge	Length	Mesh	Height	Code
2.50mm	25m	50x50mm	900mm	F9100
			1200mm	F9110
			1400mm	F9120
			1800mm	F9145
3.0mm	25m	50x50mm	900mm	F9105
			1200mm	F9115
			1400mm	F9125
			1800mm	F9150

Welded Mesh PVC Coated



- Self supporting, strong PVC coated mesh
- Ideal for perimeter fencing, less visual impact
- Green PVC coated finish RAL6055
- Black available

Gauge	Length	Mesh	Height	Code
2.5/3mm	25m	50x50mm	900mm	F9178
			1200mm	F9179
			1400mm	F9185
			1800mm	F9180

Timber Fencing

Whether you're repairing an existing fence or building a new one, we stock a wide range of posts and stakes, post and rail kits, stud rail horse fencing, including posts, struts and strainers. All our timber is supplied by fully FSC certified producers from carefully managed forests, all softwood timber is treated to BS8417.

What timber products are available at McVeigh Parker?

Pressure treated pine stakes, sawn posts, rails, strainers and boards.

Pressure creosoted pine stakes, rails, sawn posts, strainers and rails.

Sweet chestnut stakes, strainers and cleft posts and rails.

DURA² pine pressure treated stakes, rails, strainers



Pressure treated to BS8417 with a water based wood preservative that contains copper and proven organic biocides. Typical desired life on UC4 treated timber is 15 years.

Slow grown timber Scots Pine (Pinus Sylvestris), larch or similar redwood only.

This slower grown timber creates a denser wood with higher mechanical properties.

Kiln dried to an adequate moisture content in line with BS8417.

Stick layered packs to give quicker drying and better treatment penetration.



Identification marked for proof of manufacturer and full traceability.

The British standards BS8417 state timber longevity as "Desired service life". The desired service life does not provide a guarantee, but merely an indication of the expected performance of the product.



The BSEN 335 defines User classes which lists desired service life of treated timber and is intended as a guide only, the purchaser must decide whether the product is suitable for their particular purpose.

Colour Pressure treated timber has an initial natural green colouration. Once exposed to air, the green colour slowly weathers to a golden brown and in the longer term becomes a natural silver grey.

DURA² starts off almost black slowly ageing to dark brown.



McVeigh Parker stock only UC4 pine in-ground contact timber.

Use Class 4 - external timbers used in ground or fresh-water contact.

For full details on all our timber, please check out our full timber guide online or ask one of our knowledgeable team who will be happy to help.



Source: All our timber is sourced from carefully managed forests and produced by FSC/PEFC certificated producers.

DURA² Fencing

DURA² is the patented production process which is sustainable, environmentally friendly and the cost effective alternative to creosoted timber.

This new process extends the life span of the timber to 20 years and more. DURA² is the answer for those looking for a longer lasting timber fence with an attractive appearance. Guaranteed for 20 years.

The unique DURA² timber procedure starts with timber selection, with wood carefully selected from sustainable woodlands. Once felled it goes through an initial controlled drying process, then impregnated to saturation point with the improved treatment agent.

After the first treatment the timber goes through a deep drying process, then retreated once again.

This double treatment process provides the strongest protection and the most durable treated softwood timber for fencing.

This unique technique creates a fence timber of the highest quality. In addition, the wood gets a chic look due to the dark colouring without any unpleasant odours or carcinogenic properties.



DURA² EndSeal protects the exposed cut surfaces in your wood from water, mould and insect decay as well as UV, ageing and moisture in overground applications.



Dura² Endseal paint available in 750ml cans F5800

Benefits of using DURA² Timber

- Pedigree durable product.
- Controlled drying process.
- Safe to both livestock and humans, no leaching.
- Produced from slow grown European pinewood only.
- Timber treated twice with deep drying between the two treatments.
- Pressure treated with a high concentrate.
- DURA² is an enhanced and patented treatment process using Tanalith E preservative.
- DURA² has the appearance of creosoted timber without the smell or carcinogenic properties.
- Homogenous dark brown chic colour.
- 20 year manufacturer's warranty.

Click link to view full DURA² range



Check out the DURA² spec sheet. Click link above

Initially stocked in certain sizes, however larger projects and full artic loads are available, contact us with your requirements. Stockist, trade and contractor rates available.

DURA² TIMBER RANGE

Fencing stake/Strut

* 1.65m x 90mm pointed	F5820
* 1.8m x 90mm pointed	F5825
* 2.5m x 90mm pointed	F5830
2.1m x 90mm pointed	
2.7m x 90mm pointed	
3.0m x 90mm pointed	
1.8m x 100mm pointed	
2.0m x 100mm pointed	

Strainer

* 2.5m x 140mm pointed	F5840
2.5m x 160mm pointed	
2.5m x 180mm pointed	
2.75m x 180mm pointed	
3.0m x 140mm pointed	
3.0m x 160mm pointed	
* Stocked product lines	

Rails

3.60m x 87mm x 38mm Rails sawn	F5880
4.0m x 100mm x 50mm Rails sawn	
4.0m x 150mm x 47mm Boards sawn	

Sawn Posts - 4 way pointed

1.8m x 125mm x 75mm sawn post	F5870
2.1m x 125mm x 75mm sawn post	F5875

DURA² Gates and posts also available on request

Other products available by request.



3.5m x 100mm half round rail spruce

TIMBER

- **OVER £10,000,000 WORTH OF TIMBER SOLD ANNUALLY**
- **QUANTITY DISCOUNTS, TRADE RATES, DIRECT LOADS, ONE PIECE TO FULL ARTIC**
- **MECHANICAL OFFLOADING**

Pressure Treated

STOBS STOCKED IN SCOTLAND BRANCH

Pressure Creosoted

OCTOPOSTS available in some branches

DURA² Timber

Sweet Chestnut

KILN DRIED PINE ONLY

- Identification branded for traceability
- Pressure treated to BS 8417
- Kiln dried below 28% moisture content
- Sticked layers

- Winter cut
- Available in quarters / halves & rounds

McVeigh Parker have been supplying traditional fencing timber since 1979. With over one million stakes sold annually, we are confident we can provide you with quality products, at the right price, treated to the correct user class, for your next fencing project. We have a range of timber and post stakes for use as part of your traditional timber fencing project. Fencing struts and stakes with a mix of creosoted strainers are available in sizes to suit your needs.

Stakes, Strainers & Rails

Stakes ROUND

Description		Code
1.65m x 75-100mm dia round	*	F8534
1.80m x 75-100mm dia round	*	F8634
2.10m x 75-100mm dia round	*	F8734
2.40m x 75-100mm dia round		F8834
2.70m x 75-100mm dia round		F8934
3.00m x 75-100mm dia round		F8334

Stakes

Description	Code
1.65m x 50-75mm dia round	F8523
1.80m x 50-75mm dia round	F8623
2.40m x 50-75mm dia round	F8823

Stakes, Half round must have 4 way points

Description	Code
1.65m x 100-125mm half round	F8545H
1.80m x 100-125mm half round	F8645H
1.80m x 125-150mm half round	F8646H
2.10m x 100-125mm face half round	F8745H

Strainers, fourway pointed

Description		Code
1.80m x 100-125mm dia round	*	F8645
2.10m x 100-125mm dia round	*	F8745
2.10m x 125-150mm dia round	*	F8756
2.10m x 150-175mm dia round		F8767
2.4m x 100-125mm dia round		F8845
2.4m x 125-150mm dia round	*	F8856
2.4m x 150-175mm dia round	*	F8867
2.4m x 175-200mm dia round	*	F8878
2.7m x 100-125mm dia round		F8945
3.0m x 100-125mm dia round		F8345
3.0m x 125-150mm dia round	*	F8356
3.0m x 150-175mm dia round		F8356

Struts

Description	Code
2.40m x 75-100mm dia round. Blunt	* F8834S

Rails

Description	Code
3.66m x 100-125mm dia Half round	F3120

Machined half round rails

Description	Code
3.66m x 100mm dia round	* F5120

Machine Sawn Timber

Machine Rounded Stakes

Description	Code
1650mm x 60mm stake - UC4	F8M515
1650mm x 75mm stake - UC4	F8M520
1650mm x 85mm stake - UC4	F8M522
1650mm x 100mm stake - UC4	F8M525
1800mm x 60mm stake - UC4	F8M610
1800mm x 75mm stake - UC4	F8M615
1800mm x 85mm stake - UC4	F8M618
1800mm x 100mm stake - UC4	F8M620
1800mm x 110mm H/Round - UC4	F8M625
1800mm x 125mm stake - UC4	F8M630
2100mm x 75mm stake - UC4	F8M700
2100mm x 85mm stake - UC4	F8M702
2100mm x 125mm stake - UC4	F8M705
2100mm x 150mm stake - UC4	F8M706
2100mm x 100mm stake - UC4	F8M720
2400mm x 60mm stake - UC4	F8M805
2400mm x 75mm stake - UC4	F8M810
2400mm x 85mm stake - UC4	F8M812
2400mm x 100mm stake - UC4	F8M815

Machine Rounded Strainers

Description	Code
2400mm x 125mm stake - UC4	F8M820
2400mm x 150mm stake - UC4	F8M825
2400mm x 175mm stake - UC4	F8M830
2400mm x 200mm stake - UC4	F8M935

Machine Rounded Round Poles

Description	Code
3660 x 100mm Machine Round Jump Pole UC3	F5110
3000mm x 125mm Machined pole - UC3	F5105
3000mm x 150mm Machined Pole - UC4	F8M950
3600mm 150mm Machined Pole - UC4	F8M980



Sawn Timber

Posts

Description	Code
UC4 1800 x 75 x 75mm Sawn Post Redwood	F8100
UC4 2400 x 75 x 75mm Sawn Post Redwood	F8150
UC4 3000 x 75 x 75mm Sawn Post Redwood	F8175
UC4 1800 x 100 x 100mm Sawn Post Redwood	F8110
UC4 2400 x 100 x 100mm Sawn Post Redwood	F8160
UC4 2700 x 100 x 100mm Sawn Post Redwood	F8173
UC4 3000 x 100 x 100mm Sawn Post Redwood	F8180
UC4 1800 x 75 x 125mm Ptd Post Redwood *	F8120
UC4 2100 x 75 x 125mm Ptd Post Redwood *	F8140
UC4 2400 x 75 x 125mm Ptd Post Redwood *	F8170
UC4 1800 x 75 x 150mm Ptd Post Redwood	F8130
UC4 2100 x 75 x 150mm Ptd Post Redwood *	F8145
UC4 2400 x 75 x 150mm Ptd Post Redwood	F8171

Rails

Description	Code
Sawn Rail 3600 x 38 x 88mm Treated *	F6990
Sawn Rail 3600 x 38 x 100mm Treated	F6992
Sawn Rail 3600 x 47 x 100mm Treated *	F6994
Sawn Rail 3600 x 32 x 76mm Treated	F6999
Sawn Rail 4000 x 47 x 100mm Treated	F6998
Sawn Rail 4200 x 47 x 100mm Treated	F6995
Sawn Rail 4800 x 47 x 100mm Treated *	F6996

* Stocked in Pressure Creosoted

Timber Boards

Description	Code
Gravel Board 1830 x 150 x 22mm Treated	F6230
Gravel Board 1800 x 150 x 38mm Treated	F6231
Gravel Board 2400 x 150 x 22mm Treated	F6232
Gravel Board 3000 x 150 x 22mm Treated	F6233
Gravel Board 3600 x 150 x 22mm Treated	F6236
Gravel Board 3600 x 150 x 38mm Treated	F6240
Gravel Board 3600 x 150 x 47mm Treated	F6997
Gravel Board 3600 x 225 x 38mm Treated	F6238
Path Edging Board 4200 x 100 x 22mm Trtd	F6247
Path Edging Board 3600 x 100 x 22mm Trtd	F6248

Sawn Morticed Posts

Description	Code
UC4 2100 x 100 x 125mm Sawn 2WW & 2 x Twin Mortice - Blunt End	F8156
UC4 2100 x 100 x 125mm Sawn 2WW & 3 x Twin Mortice - Blunt End	F8157

Riven Chestnut Morticed Posts

Description	Code
Cleft two twin morticed posts 2.0m	F4140
Cleft three twin morticed posts 2.0m	F4145



DURABLE •
BEAUTIFUL •
DEPENDABLE •

DURA²
TREATED TIMBER
HIGH QUALITY FENCING TIMBER

DURA²® is synonymous with quality performance across Europe thanks to a patented enhance high pressured treatment base of Tanalith-E®

- Pedigree durable product.
- Controlled drying process.
- Safe to both livestock and humans, no leaching.
- Produced from slow grown European pinewood only.
- Homogenous dark brown chic colour.
- 20 year manufacturer's warranty.

See pages 36-37 for more details

Post & Rail Fencing

Timber post and rail is an iconic sight in the British landscape, both attractive and functional. Often used for paddock fencing, livestock management and roadside fencing as well as an aesthetic look for domestic properties. We stock a wide range of traditional timber post and rail options for both domestic and agricultural purposes.

The number of rails and the spacing between posts can vary depending on the intended purpose, visual preferences, and the type of animals being contained.

Half Round

Cundy half round rails, slight irregular appearance.

Rails - 3.66m x 100/125mm face

Stakes - Half round 1.8m, 2.1m, 125/150mm face

Full round 1.8m, 2.1m, 2.4m, 100/125 dia

Available in pressure treated green, UC4 pine for all in ground contact timber.



Machined Half Round

Machined half round fencing creates a more uniform neat appearance.

Rails - 3.60m x 100mm face

Stakes - Half round 1.8m, 2.1m, 110mm face

Full round 1.8m, 2.1m, 2.4m, 100mm, 125mm dia

Sawn 1.8m, 2.1m, 2.4m x 125mm x 75mm posts can also be a suitable combination.

Available in pressure treated green, Pressure creosoted and DURA² (in select sizes) UC4 pine for all in ground contact timber



3 rail with sawn morticed posts



Riven Chestnut Post & Rail

This is a traditional and durable type of fence construction that uses cleft (split) chestnut of irregular shapes which give it a unique handcrafted rustic appearance. Produced from sustainable coppiced UK woodlands.

For those looking for a more symmetrical appearance combine sawn morticed posts with cleft rails.

Rails - 2.7m x irregular profile of approx. 325-350mm girth, scarf ended. Chestnut

Posts - 2.0m x 180-210mm cleft face, twin morticed to suit two or three rail.

Chestnut 2.1m x 125mm x 100mm, twin morticed to suit two or three rail. Sawn treated

Available in all chestnut (no treatment required) or pressure treated sawn posts

(rustic style)



2 rail with riven chestnut morticed posts

Sawn (Motorway) Post & Rail

Sawn finish timber most commonly seen along motorways.

Rails - 3.60m x 88mm or 100mm x 38mm or 47mm profile

Posts - 1.8m, 2.1m, 2.4m x 125mm or 150mm x 75mm, four way pointed

Available in pressure treated green, Pressure creosoted and DURA² (in select sizes) UC4 pine for all in ground contact timber.



Post and Wire Combinations

We can supply various combinations using posts with top rail and X fence wire infill.

Contact us for more details, advice and a quote.



Did You Know?



You can extend the life and protect your fence from livestock damage by simply adding cost effective insulators to your fence. We supply a wide range of offset electric insulators, tape, rope and wire.

Click link to view full post and rail fencing product range



Domestic Fencing

Our garden fencing stock includes panel fencing, fence kits and wattle hurdles. Our attractive domestic fencing range is perfect for gardens, roadside areas or as screening.



For further details and buy now

Hazel Wattle Hurdles

Panel Garden Fencing

Feather Edge Panels



- Pressure treated softwood for longlife (not dipped)
- Fully framed
- Heavy more durable construction
- Easy to install, suitable for timber or slotted concrete posts. Just add quick mix cement

Size	Code
900mm x 1830mm (3' x 6')	F6112
1200mm x 1830mm (4' x 6')	F6114
1500mm x 1830mm (5' x 6')	F6115
1650mm x 1830mm (5'4" x 6')	F61156
1800mm x 1830mm (6' x 6')	F6116

Waney Edge Panels



- Pressure treated softwood for longlife (not dipped)
- Fully framed
- More cost effective panel option
- Easy to install, suitable for timber or slotted concrete posts. Just add quick mix cement

Size	Code
900mm x 1830mm (3' x 6')	F6103
1200mm x 1830mm (4' x 6')	F6104
1500mm x 1830mm (5' x 6')	F6105
1650mm x 1830mm (5'4" x 6')	F61056
1800mm x 1830mm (6' x 6')	F6106

Garden Fence Posts & Fittings

Panel Posts



- All sawn post sizes available on page 38-40

Size	Code
1800mm x 100mm x 100mm	F8110
2400mm x 100mm x 100mm	F8160
2700mm x 125mm x 100mm	F8173

Fence Post Panel Clips



Size	Code
50mm	A2725

Post Anchor Supports



Size	Code
750 x 50 x 50mm to drive	A2713
700 x 100 x 100mm to drive	A2710
600 x 75 x 75mm to drive	A2700

Fence Post Bolt Down Anchor



Size	Code
75 x 75mm	A2715
100 x 100mm	A2720

Hazel Wattle Hurdles

A product crafted with care and dedication from sustainable coppiced woodland.

Embracing tradition while ensuring a greener future, these hurdles are not just fences but symbols of environmental responsibility.

Approximate 3 to 5 year life expectancy for wattle hurdles



Sizes	Code
1200mm x 1800mm	F6124
1500mm x 1800mm	F6125
1800mm x 1800mm	F6126

Closeboard Gates

Our closeboard garden gate is a strong and durable option to protect your land. Made from responsibly sourced timber from well managed forests, this garden gate can be left or right side hung and adds a complementary finish to your closeboard fencing.



Sizes	Code
900mm x 1800mm	WG870
900mm x 1750mm Heavy Duty	WG878
1200mm x 1750mm Heavy Duty	WG879

Closeboard Components

Arris Rail - Scarfed Ended



Arris Rail - Plain Ended



Arris Rail Fixing Bracket F6261

- Used to fix arris rails to wooden support posts
- Ideal for new fences and easy repairs
- Manufactured from galvanised steel
- 285mm (L)



Counter Rail



- Counter rails are added to the top of the fence to provide support

- Used as support rails for closeboard/feather edge fencing or timber palisade/pale fencing
- Manufactured from pressure treated softwood timber

- Triangular shaped horizontal rails to pin the feather edge boards to flat ends and can be attached to the posts using arris rail brackets
- Strengthens the system and enhances the style

Size (mm)	Code
2400mm x ex75mm x 75mm ended	F6262
3000mm x ex75mm x 75mm ended	F6265

Size (mm)	Code
3000mm x 75mm x 75mm plain ended	F6264

Size (mm)	Code
2400mm x 50mm x 22mm	F6272
3000mm x 50mm x 22mm	F6273
3000mm x 50mm x 38mm	F6271

Palisade Fencing Timber & Gates

Palisades

- Nail-on palisade
- Pressure treated softwood timber
- Available in round and pointed top



Round Top Pales

Size (mm) (H x W x D)	Code
900mm x 75mm x 22mm	F6150
1050mm x 75mm x 22mm	F6153
1200mm x 75mm x 22mm	F6152
1500mm x 75mm x 22mm	F6156
1800mm x 75mm x 22mm	F6158

Made to order, this is the morticed version of pointed top palisade



Pointed Top Pales

Size (mm) (H x W x D)	Code
900mm x 75mm x 22mm	F6151
1050mm x 75mm x 22mm	F6154
1200mm x 75mm x 22mm	F6155
1500mm x 75mm x 22mm	F6157
1800mm x 75mm x 22mm	F6159



We recommend the following post and rails...

- Sawn Post - 1800mm x 75x75mm - **F8100**
- Sawn Post - 1800mm x 100x100mm - **F8110**

- Sawn Rail - 3600mm x 38x88mm - **F6990**
- Supplied in kit forms



Wooden Palisade Gates

- Pressure treated softwood timber
- Responsibly sourced timber from well managed forests
- Available in pointed or round top
- Left or right hanging

Round Top Palisade Wooden Gate



Size (mm) (H x W)	Code
900mm x 900mm	WG804
1200mm x 900mm	WG805
900mm x 1200mm	WG809
1200mm x 1200mm	WG808

Pointed Top Palisade Wooden Gate



Size (mm) (H x W)	Code
900mm x 900mm	WG802
1200mm x 900mm	WG803
900mm x 1200mm	WG806
1200mm x 1200mm	WG807

Dura Steel Slotted Posts

DuraPost[®]
A lighter, stronger and easier to fit galvanised steel fence post in a range of four colours.

Available Post Colours

Anthracite Grey

Olive Grey

Sepia Brown

Galvanised Steel



For further details



Concrete Posts & Gravel Boards

Concrete Slotted Posts

Description	Post Length	Fence Height	Code
Slotted END Concrete Post	2400 x 100 x 85mm	1.8m	CP1315
Slotted CORNER	2700 x 125 x 125mm	1.8m	CP1320
Slotted CORNER	1800 x 125 x 125mm	1.2m	CP1120
Slotted Concrete Post	3000 x 100 x 87mm	1.8m	CP1412
Slotted Concrete Post	2700 x 100 x 85mm	1.8m	CP1410
Slotted Concrete Post	2400 x 100 x 85mm	1.8m	CP1310
Slotted Concrete Post	2100 x 100 x 85mm	1.5m	CP1210
Slotted Concrete Post	1800 x 100 x 85mm	1.2m	CP1110
Slotted Concrete Post	1500 x 100 x 85mm	0.9m	CP1010



- Much stronger and longer lasting than wooden posts
- Ideal for our panel fencing range
- Available in different heights

Concrete Gravel Boards



- Used at ground level to protect the panels above from moisture in the ground.
- Longer lasting alternative to wooden gravel boards.

Size	Code
Concrete Gravel Board 1830 x 50 x 300mm	CL5045
Concrete Gravel Board 1830 x 50 x 150mm	CL5049
* Concrete Gravel Board 2885 x 50 x 150mm	CL5050
* Concrete Gravel Board 3000 x 50 x 150mm	CL5051

* Notched gravel board to be used in conjunction with morticed concrete post

Concrete Repair Spur

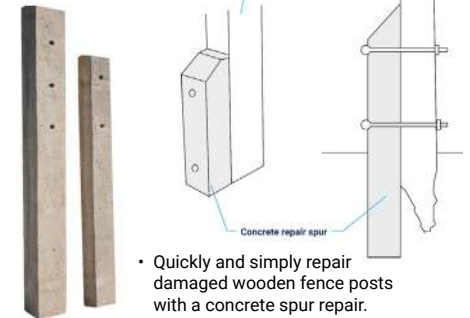

- Quickly and simply repair damaged wooden fence posts with a concrete spur repair.

Size	Code
1065mm x 75mm x 75mm	CL5010
1215mm x 100mm x 100mm	CL5020

Cleats for Concrete Gravel Boards

Size	Code
Angle Cleat for Concrete Gravel Board 75 x 50 x 40mm x 6mm galvanised	F6256
Two Pin Gravel Board Cleat - Galvanised for concrete posts and morticed posts	F6257



Two pin gravel board cleat, F6257

Feather Edge Garden Fence Panels

Feather edge fencing is supplied in kit form to give you a pleasing uniform appearance with excellent strength.

They are partially overlapped vertically.

Feather Edge Board
F6218

Panel Post Options
All sawn post sizes available on page 38
Go online or contact us for closeboard components.
Most popular sizes F8110 & F8190

Nails
FX1451

Cleats
150x50x38mm
F6250

Gravel Board Centre Peg
F6255

Arris Rail
F6262 - 2.4m
F6265 - 3m

Capping Rail (optional)
F6270

Gravel Board
3000x150x22mm
F6233

Counter Rail (optional)
F6273

UC4 Redwood Mortice Post
F8190

Did You Know?
We also sell Quick Mix / Cement, Panel Clips, Steel Post Anchor Supports, Concrete Repair Spurs

Visit one of our depots, our website or call us

Contact us for alternative specifications.

Use the depot map at the back of this catalogue for full details.

Click link to view full product range

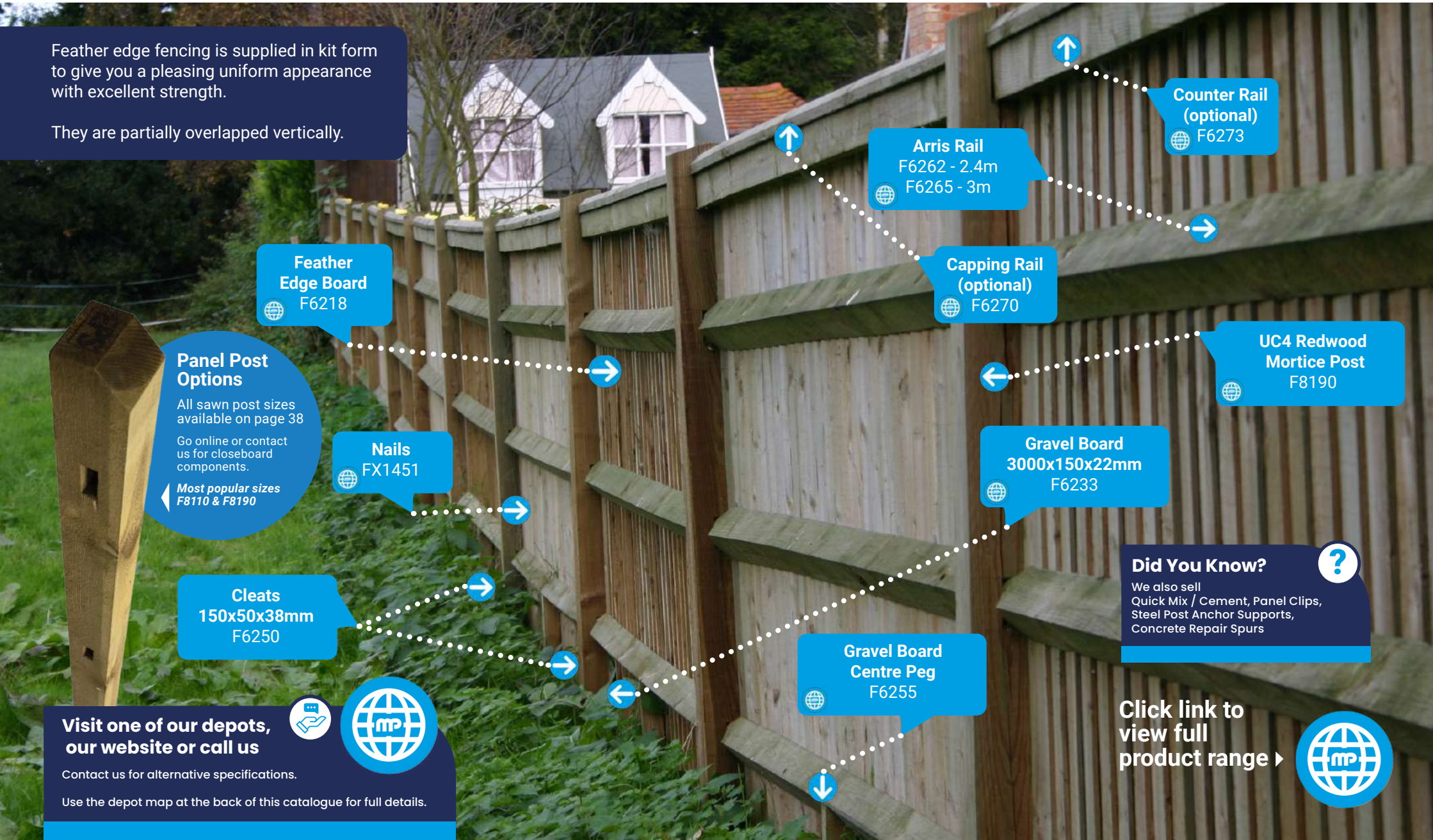

Instruction guide for fence post installation

Use the guide below to help you with your fence post installation.

- 1 Calculate the hole size needed for the fence post. This depends on post height and style of fence.
- 2 Fence posts can be set in concrete or soil with a 50mm ballast bed (see Fig 1 & 2), which will allow good drainage around the post base.
- 3 It is recommended 1/3 of fence post height is placed into hole for added stability.
- 4 Fence posts should not be placed on top of concrete (see Fig 4). It will prevent post drainage and will lead to early failure under some weather conditions.
- 5 Concrete should be poured 50mm from ground line.
- 6
- 7 The remaining part of the hole should be filled with ballast or gravel to allow post drainage. This will also restrict weed growth at post base which can cause damage.

An alternative fence post installation guide can be seen in Fig 3.

Use illustrations below with the guide above to further assist with installation

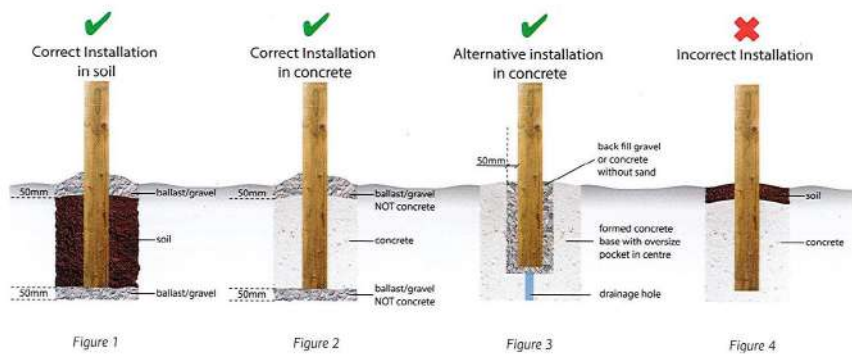

THE SAFE CHOICE FOR YOUR SECURITY FENCING

- » Steel Palisade
- » Mesh Panel Systems
- » Vertical Bar Railings
- » Bow Top Railings
- » 358 Security Mesh
- » Chain link Fencing
- » Welded Mesh
- » Bespoke Fence Options
- » Concertina Barbed
- » Timber Acoustic
- » X Fence



See pages 32-34 for our security fencing range





Click link to see full range.



✓ Approved supplier
✓ Largest quality electric fence brand

✓ First class products, fully user tested
✓ 7 year warranty on all energisers
subject to T&C's for 7 year guarantee

Electric Fence Fittings



Use the following electric fence fittings menu to find the parts you need.
Click the links below (if active) to direct you to our live product pages.

- | | | | | | |
|---------------------------------|---------------------------------|--|---|---------------------------------------|---------------------------------------|
| 1

Vandal Proof Box | 2

M50 Mains Energiser | 3

MB150 Battery Energiser | 4

M550 Mains Energiser | 5

S40 Solar Energiser | 6

S20 Solar Energiser |
| 7

Neontester | 8

Fault Finder | 9

Cut Off Switch | 10

Electricity Warning Sign | 11

Sheep Netting | 12

Rabbit Netting |
| 13

Poultry Netting | 14

Spring Gate Set WHITE | 15

Soft Touch Gate handle TERRA | 16

Soft Touch Gate Handle (Tape) TERRA | 17

Elastic Rope Gate Set WHITE | 18

String Insulator Reinforced |
| 19

Inline Wire Tensioner | 20

Joint Clamp Bobbin | 21

Gate Anchor 2 Way Screw In Insulator | 22

Drill Chuck Pro | 23

Tape Joiner 20mm | 24

Offset Screw In Insulator |



Have You Seen?

Weighing and EID Systems

McVeigh Parker are a main Gallagher stockist. Gallagher have more than 80 years of experience in the agricultural sector, they are at the forefront of new developments, especially in the field of weighing and EID solutions. We stock a complete range of equipment for weighing, data collection and stock management.



Click link to find out more details.

- | | | | | | | |
|--------------------------|---|-------------------------------------|--|---|---------------------------------|------------------------------|
| 25

W Insulator | 26

CLIPLEX Live Tip Offset Insulator | 27

Screw In Ring Insulator | 28

Gate Handle 3 Way Screw In Insulator | 29

Heavy Duty End Strain Insulator | 30

Wire Offset Insulator | 31

Geared Reel Sets |
| 32

Turboline BLUE | 33

Vidoflex 6 Powerline WHITE | 34

Powerline Tape 40mm WHITE | 35

Underground Cable | 36

Horse Post Stirrup | 37

Pigtail Post | 38

Plastic White Post |

Electric Fence Fittings



- | | | | | |
|---------------------------|----------------------------------|---|---|--|
| 43

Activator Strap | 44

Hi Test Insul Strainer | 45

Premium Electric Bungy Cord: 100m | 46

Joule Shield Wood Post Claw Insulator | 47

Joule Shield Wood Post Pinlock Insulator |
|---------------------------|----------------------------------|---|---|--|

For more information contact your nearest branch



McVeigh Parker are proud to be European wholesalers and retailers of this quality range of products.



Click link to check out the range on our website.

Electric Fencing

Electric fence setups come in all shapes and sizes. This diagram illustrates the different parts needed for a semi - portable setup.

CLIPLEX Insulators
EF2055

CLIPLEX Eco Post 1.8m
CL2710

High Tensile Wire 25kg Galvanised
F2104

Lead Out Cable - 25m
EF3099

Joint Clamp
EF4055

XDI Screw In
EF2028

Heavy Duty End Strain Insulator
EF2020

Medium Gripples
A1520

Our electric fencing range includes everything you need to set up a complete electric fencing run, from leading manufacturers including Gallagher and Strainrite. See our range of energisers, stakes, wire, tape and insulators now.



Click link to view full product range



Equestrian

Gallop into your equine projects with ease



mcveighparker.com

Equestrian

57



Bridle Gates



Browse our selection of horse gates which provide secure, easy access to equestrian paddocks or fields, along with our self-closing bridle gates perfect for bridle ways. We also supply horse friendly gate fittings perfect for both horse and rider.



Equine Electric

Electric fencing is used to protect paddocks and your post and rail. We supply PVC stud rail, Equifence hot line and our market leading X Fence horse netting. Combine any of these with UC4, DURA² or creosoted timber for a longer maintenance free life.



Stokbord



Stokbord is a general purpose durable board, ideal for use with horses and other livestock thanks to its chew-proof non-toxic nature. Whether you are looking to create a lunging pen, line your stable or clad your horse-walker, Stokbord is multi-purpose & maintenance free.

Riding Arenas



Our riding arena kit is designed to provide all you need to construct your own horse riding arena including rail fencing, retaining boards, softwood gates, spun and woven membrane, perforated land drainage to ensure adequate drainage for functionality in all weather and all the fittings required. All you will need to complete is your own choice of hardcore or toppings.



Stable Supplies



Our stable supplies include horse feeders and drinkers, stable mats and stable lining, wheelbarrows and grass protection mats. McVeigh Parker has been providing premium quality equestrian supplies since 1979 that have all been specifically selected by our equestrian experts.

From stable mats to storage bins and all material integral to building a riding arena, we pride ourselves on our industry knowledge, commitment and expertise.

Equestrian Fencing



Equestrian fencing comes in many forms. We stock the ever popular traditional post and rail in various profiles. Half round, sawn, pressure treated, creosoted softwood, DURA² treated softwood or riven chestnut. Combine with X fence horse netting for added security. Available in a wide range of sizes to suit various budgets and requirements.



To view the complete McVeigh Parker equestrian product range simply click the link to the right. ▶

Or use the following URL:
www.mcveighparker.com/equestrian



Riding Arenas

If you are looking to install a commercial, private outdoor arena or lunge arena, we can offer you a comprehensive range of products from fencing, boards, gates, land drainage, membrane to full kits plus windbreak and wheelbarrows (*Just add your choice of topping and stone, not supplied by us*).

Full kits supplied at very competitive prices. We can offer various options to suit all budgets. For repair or DIY, individual components can be purchased separately.

Woven Base Membrane LDP700

Perforated Land Drainage Pipe 100mm LDP102

Perforated Land Drainage Pipe 80mm LDP080

Land Drainage Y Junctions LDP506

Click link for riding arena product range



Nails FX100

Class 4 Sawn Post F8140

Non Woven Top Membrane LDP726

Sawn Rail Treated F6990

Softwood Gate 3.6m WG712HB5R

Horse Friendly Auto Catch WGF105

Hinge Set 600mm WGF120

Class 4 Treated Gate Posts WGP830

Retaining Boards F6240

Do You Need?

A bespoke, long lasting, eco friendly fencing solution?

DURA² is the patented production process which is sustainable, environmentally friendly, and the cost effective alternative to creosoted timber. Then check out our DURA² timber product range.

Alternative arena sizes and specifications available.

DURA² photo on show, pressure treated green version stocked.



Riding Arenas

Riding Arena Kit 40m x 20m KRA



Installation Guide:
Check out spec sheet online

This new upgraded kit includes an improved heavier top layer spun membrane

- 66 x Retaining Boards 3.6m x 150mm x 38mm
 - 99 x 3.6m x 38 x 87mm Sawn Rail Treated
 - 66 x Class 4 2.1m x 75 x 125 Ptd Sawn Post
 - 10 x 1kg bag R/Head Nail 100mm galv
 - 2 x Perforated Land Drainage Pipe 80mm x 100m
 - 1 x Perforated Land Drainage Pipe 100mm x 50m
 - 10 x Land Drainage Y Junctions 100mm
 - 3 x 100m x 4.5m Woven geotextile membrane black
 - 3 x 4.5m x 100m fibre 140 membrane, standard
 - 1 x 3.6m Softwood treated heavy bottom rail gate
 - 1 x Horse friendly auto catch & striker
 - 1 x Hinge Set 600mm Adj B/Hinge P/Pack Galv
 - 2 x Class 4 2.4m x 175mm x 175mm Treated Post
- All pressure treated softwood for long life

Optional upgrade extras available such as DURA²
Other sizes available please contact us to discuss your requirements

TurboStar Equifence 250m EF3031



- The safest and most durable wire for horses with a 10 year guarantee
- Optimal conductive plastic cable with a 2.7 mm galvanised wire core
- No oxidation because of plastic/carbon covering
- Highly visible because of 7.5 mm diameter
- Available in terra and white
- 250m roll

Stud Rail



Studrail is a cost effective polyethylene & high tensile wire bonded rail

Colour	Width	Code	
B= Brown	75mm	F2501 B	F2500 W
W= White	100mm	F2503 B	F2502 W
100m Roll			

Horse Rail

Horse rail is manufactured from high-quality medium density polyethylene that won't fade, splinter or shatter. Highly Conductive Carbon Compound strip can be electrified, encompasses 2 or 3 high tensile 2.5mm wires.

Available in brown, black and white

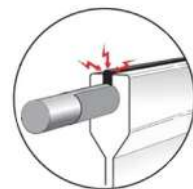

Hot-Top 2 line - Top line can be electrified

Hot-Top 3 line - Top line can be electrified

Hot-Top plus 3 line - Top & bottom can be electrified

Feed Storage

Feed Bins



Capacity	Partition	Code
630L	1 (2 Sections)	TC6340
840L	2 (3 Sections)	TC6370

JFC Feed Storage Bin JFCCMB05

Strong & durable feed storage bin with a low profile for ease of access when filling & emptying. The Easy Empty Cubic Metre Bin also tilts for easy access & has a smooth interior base without crevices for ease of emptying with a standard bucket.



Stable Mats

Rubber Ring Mat TH5105



- 1.5m x 1.0m x 23mm
- 25mm holes allow efficient drainage
- Resistant to all weather and extreme temperatures

Rubber Stable Mat TH5100



These hard wearing natural rubber mats are grooved one side and dimpled the other. They provide higher hygiene and better cushioning as well as thermal insulating properties.

- Mat Size: 1.8m x 1.2m x 17mm

Stable Lining

Stokbord



Thickness	Sheet Size	Code
3mm	2440mm x 1220mm	F6002
6mm		F6000
9mm		F6005
12mm		F6010
18mm		F6012

- UK's leading sheet board brand
- 100% recycled plastic
- Maintenance free - never needs painting or treating



Click link to view full equestrian product range

Windbreak Netting

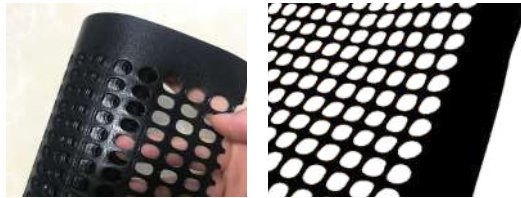

Reinforced edges for a stronger longer lasting windbreak

General Purpose Windbreak Netting

Available in black or green.
This windbreak provides an effective protection for plants, shrubs and livestock.
Mesh Pattern: 15x4mm

Height	Length	Colour	Code
1m	30m	Green	NET100



Bayscreens



Rollerscreens



Agri-door

Bayscreens

- Suitable for permanent fixing of infrequent access
- Quick to install and remove
- Offers weather protection but allows ventilation
- Flame retardant
- Tear and fray resistant material
- Rot proof
- Designed to clip onto bays or wider spans up to 20m



Rollerscreens

- Designed for regular access
- Rapid opening mechanism
- Offers weather protection and variable ventilation
- Fully adjustable to fit opening
- Complies with EC door directive EN-13241
- Heavy duty spring allows fast access with a locking mechanism to stabilise against wind pressure



Agri-door

- Fully adjustable to fit
- High speed chain drive
- Steel wind bars
- Replacement panels
- Complies with EC door directive EN-13241
- Ideally suited to grain stores and bulk feed stores
- Suitable for installing on the inside or outside of buildings



Call us today for more information and to book your **FREE** site consultation

Hay Feeders

JFC Haybell

JFCHB01

- Designed to fit over a standard round bale.
- Manufactured from robust polyethylene it has no metal components making it extremely safe for use with animals.
- Designed with 4 feeding ports it enables 4 horses to feed simultaneously.



Hay Soaker

JFCHS1

- Capacity: 300L
- Dimensions: 1200L x 600W x 800H
- Swivel Wheels: 1 for optimal maneuverability
- Drain Feature: DOF1 fitted for easy water drainage



Trailers & Wheelbarrows

JFC Tip Assist Trailer

JFCATV500TA



- Gas strut to assist with load tipping.
- Metal support frame capable of handling heavy loads up to 500kg.
- Robust polyethylene body mounted on a galvanized metal frame.
- Equipped with a lever ball hitch.
- Protective steel plate on the front lip to prevent damage from impacts.
- Strong hinge point for effective load tipping.
- Two roller bearing 4-ply pneumatic wheels.

Tipping Wheelbarrow 250 litre capacity

JFCTWB5



- Twin wheeled with bearings
- Hot dip galvanised chassis
- Heavy duty moulded plastic pan

Tipping Trailer - 250 & 500 litre capacity

JFCTL



- Ideal for large gardens & estates
- Great for golf courses & parks
- Tows easily behind an ATV
- x2 sizes

Twin Wheelbarrow - 250 litre capacity

JFCTWB



- 1800 x 865 x 720mm
- Galvanised frame and polyethylene body ensures a long-life span.
- Replacement wheels and handle grips available.
- Twin puncture proof tyres

JFC ATV Fertiliser Spreader (Manual Control)

JFCATVS500M



- Suitable for operation on sloping and mountainous terrain due to its low centre of gravity and wide wheelbase
- Large hopper capable of transporting and spreading up to 500kg of most fertiliser types.
- The spreader has a 12m spreading width running at 15km/hr

**Our wooden gates,
hand crafted in the UK**



Wooden Gates



Our wooden entrance gates are suitable for domestic and commercial use. Popular products include our Universal and Yeoman Curved gate which are both available in hardwood and softwood options. We stock a wide range of gates in a wide range of sizes online and in depot.



Right Of Way Gates

Our range of ROW gates includes a variety of options allowing entry for pedestrians, dogs, wheelchair and mobility vehicle users whilst ensuring your livestock stay secure.



Bespoke Gateway Products

Our bespoke gate range includes a selection of cattle grids; ideal for providing vehicle access to land whilst preventing the (escape) free movement of cattle and other roaming livestock. For any other bespoke projects contact us.

Gate Posts



Choosing the right gate post is crucial to ensure the longevity of your gate. Our range includes a selection of posts to ensure stability of your gate.



Gate Fittings



We stock a comprehensive range of heavy duty gate fittings to suit metal and wooden gates, whether you are installing a smaller entrance gate or a large metal field gate. We have a closing or hanging fitting to suit.

We stock thousands of gates to suit all purposes, domestic, commercial, industrial and agricultural. Deer gates, farm gates, metal and wooden gates through to ROW gates. We also stock heavy-duty fittings to work across our whole range. Our gates are all high quality and provide a good level of security. We even offer made-to-measure bespoke garden gates and cattle-gates, so you can ensure the perfect fit every time.

Metal Farm Gates

From field to farm, from stable to yard we have a metal gate to suit various applications. We have a made to measure service for livestock systems and bespoke projects.

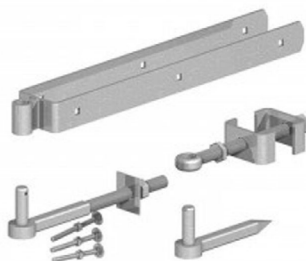

To view the complete McVeigh Parker gate product range simply click the link to the right. ▶

Or use the following URL:
www.mcveighparker.com/gates



Metal Field Gates

We have a wide selection of metal field gates available in a variety of styles and sizes to suit. Available singularly, in pairs and with a choice of fastening, our range of metal field gates will not disappoint.

Ashbourne 7 Rail Metal Field Gate



- Available in 14 widths
- All sizes stand at 1143mm high
- Both D Loop or Spring bolt locking styles available

▲ Fitted with sleeved gate eyes

- Metal Gates Ashbourne 7 Rail
- High quality field gates with box section ends.
- Exceptional strength means it is suitable for most livestock including horses
- Hot dip galvanised to BS EN ISO 1461 for exceptional corrosion resistance
- Classic design seen right across the country

Metal 7 Rail & Half Meshed Field Gates

Width	Locking Style	Code	HM Code
915mm	Spring Bolt	GAB03S	GHM03S
1220mm	Spring Bolt	GAB04S	GHM04S
1525mm	Spring Bolt	GAB05S	GHM05S
1830mm	Spring Bolt	GAB06S	GHM06S
2130mm	Spring Bolt	GAB07S	GHM07S
2440mm	Spring Bolt	GAB08S	GHM08S
2745mm	Spring Bolt	GAB09S	GHM09S

Width	Locking Style	Code	HM Code
3050mm	Spring Bolt	GAB10S	GHM10S
	D Loop *	GAB10D	
3355mm	Spring Bolt	GAB11S	GHM11S
	D Loop *	GAB12D	
3660mm	Spring Bolt	GAB12S	GHM12S
	D Loop *	GAB15D	
3965mm	Spring Bolt	GAB13S	GHM13S
	D Loop *	GAB15D	
4270mm	Spring Bolt	GAB14S	GHM14S
	D Loop *	GAB15D	
4575mm	Spring Bolt	GAB15S	GHM15S
	D Loop *	GAB15D	
4880mm	Spring Bolt	GAB16S	GHM16S
	D Loop *	GAB15D	

Metal Gate Locking Styles



Spring Bolt



D Loop

Did You Know?

For added security on your gate hinge you can add an anti-theft collar.



Metal 5 Rail Cattle Yard Gates

The 5 rail Cattle Yard gate is a strong gate suitable for use in open dairy cattle yards. For added security it is fitted with a keyhole/pendulum sliding bolt as standard. This gate is 1143mm high and is available in a selection of widths.

GW12S

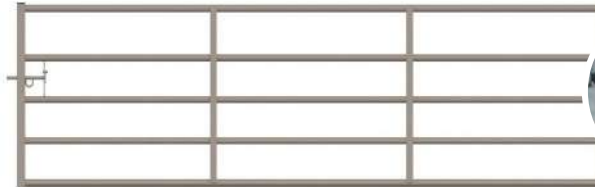

Fitted with a Pendulum slid bolt lock

- Keyhole/pendulum sliding bolt as standard (for added security)
- Sleeved 50 x 50mm box section hanging stile
- 50mm x 50mm SHS latch end
- Top and bottom rails are 48.3mm o/d CHS
- Intermediates rails 44.5mm o/d CHS
- 1143mm high. Designed to hang at 1.2m

Gate Width Options		
915mm	2745mm	4270mm
1220mm	3050mm	4575mm
1525mm	3355mm	4880mm
1830mm	3660mm	
2440mm	3965mm	

Metal Sheeted Yard Gates

SVG



Fitted with a Pendulum slid bolt lock

- Two rail options
- 3 rail - Moorland sheeted gate
- 4 rail - Buxton sheeted gate (heavy duty)
- Suitable for livestock and machinery containment
- Made from 40mm and 50mm box section
- Fitted with one sided pre-galv. steel sheet
- Gates ideal for exposed positions



NEED MORE INFORMATION?

Use our spec sheets to find out more



Click the link to view our full spec sheet list

Metal Gate Posts

We have a range of metal gate posts suitable for hanging various gate fittings including hanging posts, slotted latch posts, auto catch posts and dual latch posts. All of our metal gate posts are made of quality steel and are designed to be strong and durable, suitable for agricultural and commercial use.

Slotted Post



- Hot dip galvanised
- Fully welded tops

Size	Code
88.9mm x 2000mm	GPS1G
114.3mm x 2000mm	GPS2G
100mm x 100mm x 2000m	GPS4G

Dual Slotted Post

Size	Code
114.3mm x 2000mm @ 90°	GPSD290
114.3mm x 2000mm @ 180°	GPSD2180

Standard Hanging Posts



- Hot dip galvanised
- Fully welded hinges
- Fully welded tops
- 2 hinge styles available
- Spacings to suit Ashbourne field gates

Size	Code
88.9mm x 2000mm	GPH1G
" Inverted top hinge	GPH1RPG
114.3mm x 2000mm	GPH2G
" Inverted top hinge	GPH2RPG
114.3mm x 2286mm	GPH276
100mm x 100mm x 2000mm	GPH4G

Ground Socket

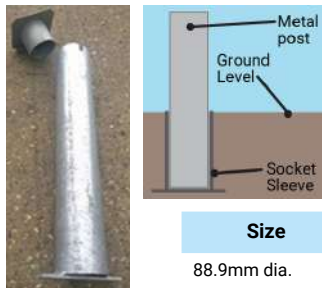

- Hot dip galvanised
- 610mm long
- 3.0mm thick

Size	Code
88.9mm dia.	GPSKT1
114.3mm dia.	GPSKT2
100mm x 100mm	GPSKT4

Auto Catch Post



- Suitable for Ashbourne D Loop

Size	Code
88.9mm x 2000mm	GPA1G
114.3mm x 2000mm	GPA2G

Deer Gates & Posts

Ideal for deer fencing and deer enclosures, the deer gates we have to offer are the very best choice for reliability and strength. Our deer gates provide you with a secure entry and exit point to your deer fencing without weakening the enclosure. All of our metal deer gates are fully meshed and have universal hanging with a central sliding bolt and with the option of metal or wooden posts depending on preference.

Wooden Deer Gate



- Made to measure
- Features morticed joints for added strength & optional heavy bottom rail for extra rigidity
- Available in lengths up to 3600mm long

Fully Meshed Deer Gate



- Suitable for containing or excluding deer
- 1860mm high, 75mm mesh cladding and lockable sliding bolt
- Fully galvanised to BS EN ISO 1461
- It is available in lengths from 0.6m (1'9") – 4.88m (16'0")
- Can be hung as pairs

Deer Post Options

Post	Dimensions	Details	Code
Slotted deer post	2.59m x 114mm	Slotted latch post	GPSDG2G
Hanging deer post	3.05m x 114mm	c/w 16mm base hole for re-bar reinforcement	GPHDG2G
Wooden gate post	3m x 175mm x 175mm		WGP383

Lagoon Security Gates

The Lagoon Gate is a 3 railed gate clad with 50 x 50 x 4mm welded mesh with extensions for barbed wire. It is 1270mm (4'1") high and supplied with a padlockable sliding bolt. It is hot dipped galvanised to ensure a maintenance free life.

- 3 railed gate clad with welded mesh with extensions for barbed wire
- Available in a variety of sizes
- A made to order item



Wooden Gate Build Essentials

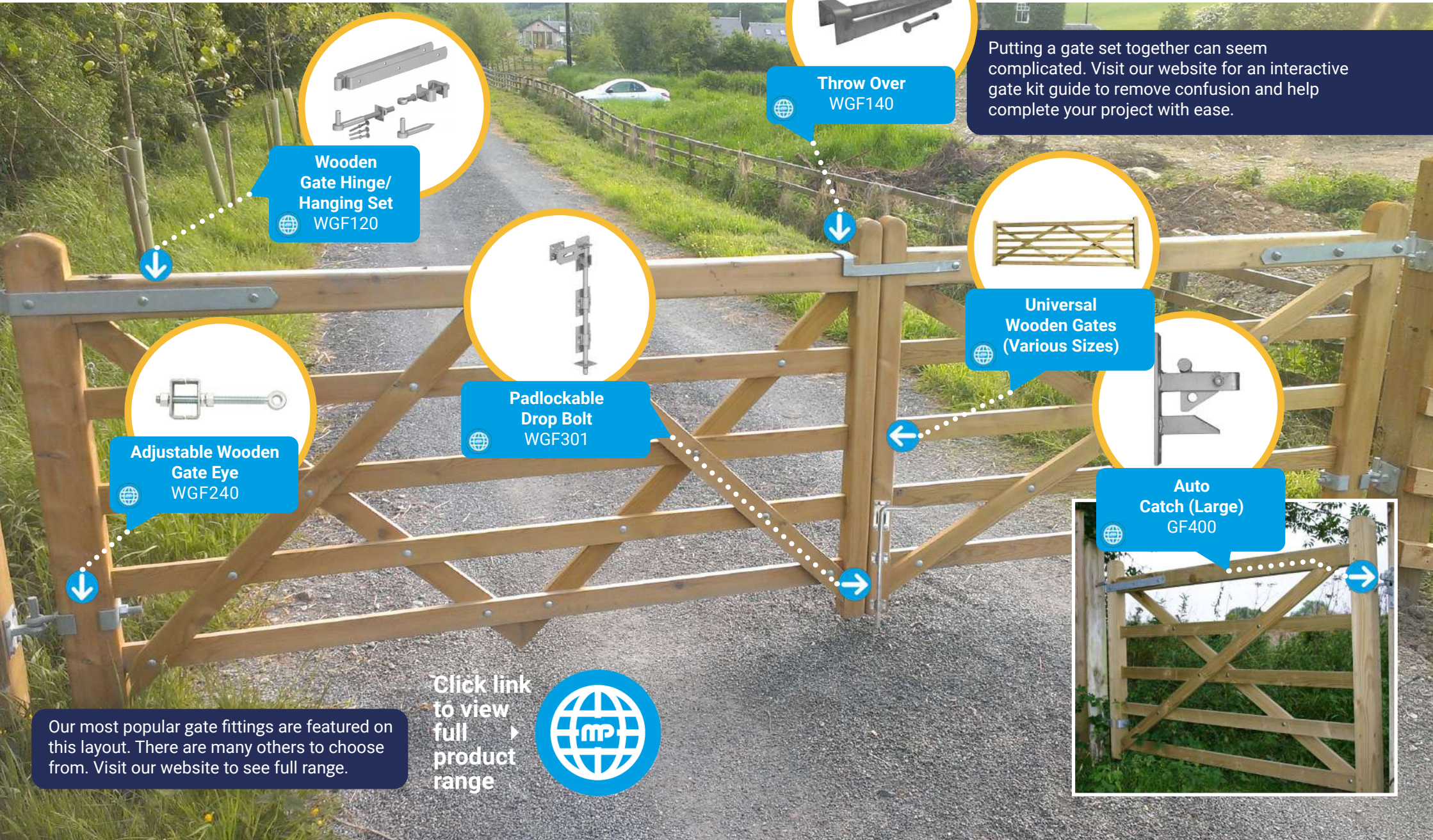

Wooden Gate Hinge/Hanging Set
WGF120



Throw Over
WGF140

Putting a gate set together can seem complicated. Visit our website for an interactive gate kit guide to remove confusion and help complete your project with ease.

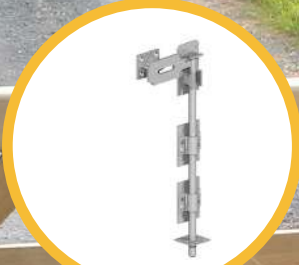

Padlockable Drop Bolt
WGF301



Universal Wooden Gates
(Various Sizes)



Adjustable Wooden Gate Eye
WGF240

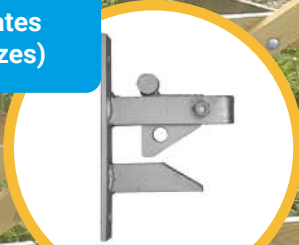

Auto Catch (Large)
GF400

Our most popular gate fittings are featured on this layout. There are many others to choose from. Visit our website to see full range.

Click link to view full product range



Universal Five Rail Gates

Heavy Bottom Rail - now as standard



Softwood Option

- Made from kiln dried Scandinavian Redwood
- Tanalith E pressure treated for long service life
- Full width heavy top rail for added strength
- Galvanised fittings

Hardwood option (made to order)

- Iroko the premier hardwood – teak like qualities mean low maintenance
- Full range of fittings and posts available to suit all the options available
- Gates can be hung as single leaf or as a pair
- Universal Gate – Distinctive traditional double cross braced high quality 5 bar drive or field gate.

All gates featured have a height of 1200mm

Width	Pattern	Code
915mm (3ft)		Softwood: WG703HB5R
1220mm (4ft)		Softwood: WG704HB5R
1525mm (5ft)		Softwood: WG705HB5R
1830mm (6ft)		Softwood: WG706HB5R
2135mm (7ft)		Softwood: WG707HB5R
2440mm (8ft)		Softwood: WG708HB5R
2745mm (9ft)		Softwood: WG709HB5R
3050mm (10ft)		Softwood: WG710HB5R
3355mm (11ft)		Softwood: WG711HB5R
3660mm (12ft)		Softwood: WG712HB5R
3965mm (13ft)		Softwood: WG713HB5R
4270mm (14ft)		Softwood: WG714HB5R
4575mm (15ft)		Softwood: WG715HB5R

Please note, all wooden gates are in imperial lengths

Universal Six Rail Gates

- Heavy bottom rail options stocked
- Heavy bottom rail to suit electric gate installations
- 6 rail option to suit those with dogs / sheep
- Hardwood timber option available in all designs

Available in 10 widths, starting at 0.90m up to 3.60m

Features

- Heavy solid top rail ex90mm x 70mm PAR for the entire width of the gate for added strength.
- The popular diamond braced design also gives added strength to the gate
- Morticed rails and cross bracing ex70mm x 20mm are all held together with zinc coated nuts and bolts
- Stiles are 95mm x 70mm both with rounded tops
- Heavy bottom rail 70mm x 70mm planed finish
- Height to top of hanging stile is 1.2m (47"). Standard sizes range from 0.9m (3") to 4.57m (15")
- Full range of fittings and posts to suit various options stocked



Heavy Bottom Rail Gate Benefits



Heavy Bottom Rail - now as standard

Hardwood option available on request

5 & 6 Heavy Bottom Rail Gate Rail Spacings

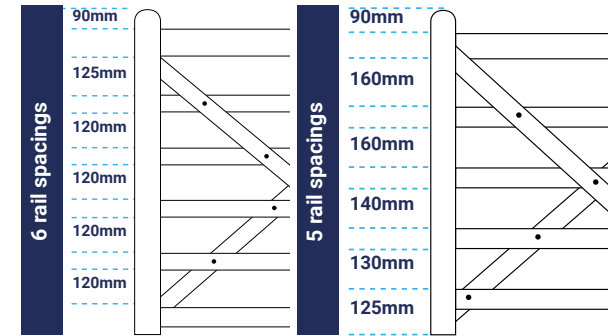

ADDED STRENGTH



ADDED SECURITY



SUITABLE FOR ELECTRIC MOTORS (Automatic Gates)



Width	Pattern	Code
915mm		WG703HBR
1220mm		WG704HBR
1525mm		WG705HBR
1830mm		WG706HBR
2135mm		WG707HBR
2440mm		WG708HBR
2745mm		WG709HBR
3050mm		WG710HBR
3355mm		WG711HBR
3660mm		WG712HBR

All gates featured have a height of 1220mm

Yeoman Gates



Width	Height	Pattern	Code
900m	1.2m		Softwood: Left: WG503L Right: WG503R Hardwood: Left: WG403L Right: WG403R
1.20m	1.2m		Softwood: Left: WG504L Right: WG504R Hardwood: Left: WG404L Right: WG404R
1.50m	1.2m		Softwood: Left: WG505L Right: WG505R Hardwood: Left: WG405L Right: WG405R
1.80m	1.2m		Softwood: Left: WG506L Right: WG506R Hardwood: Left: WG406L Right: WG406R
2.10m	1.2m		Softwood: Left: WG507L Right: WG507R Hardwood: Left: WG407L Right: WG407R
2.40m	1.2m		Softwood: Left: WG508L Right: WG508R Hardwood: Left: WG408L Right: WG408R
2.70m	1.2m		Softwood: Left: WG509L Right: WG509R Hardwood: Left: WG409L Right: WG409R

Softwood Option

- Tanalith E pressure treated for long service life
- Available in left or right hanging in a wide range of widths
- Galvanised fittings

Hardwood Option

- Iroko the premier hardwood – teak qualities mean low maintenance
- Full range of fittings and posts available to suit all the options available

Heavy bottom rail versions also available



Click link to view full product range



Designs for Easy Access To Rights of Way



KISSING GATES - BRIDLE GATES - STILES - PEDESTRIAN ACCESS GATES



MANAGE ACCESS TO YOUR LAND - BESPOKE DESIGNS ALSO AVAILABLE



TRADE DEALS - UNBEATABLE VALUE - GREAT RETURNS ON INVESTMENT



Click link to view Centrewire range



Right Of Way Gates

Woodstock Pedestrian Kissing Gate



- Height - 1.0m - 1.2m
- Maximum length in the fenceline - 2.0m
- Width across the hoops - 1.2m

Size	Code
Plain Hoops	RW38
Meshed Hoops	RW39

Mobility Friendly Meshed Medium Woodstock Gate



- Allows easy manual wheelchair and standard pushchair access
- Fully stock proof in both directions
- Easy to install

Large Size Available On Request

Braemar Deer Gate



- Easy to install, unit comes in one piece.
- The H-frame provides the whole system with rigidity and ensures the gate leaf is always correctly aligned with the frame
- When in the closed position, the gate is secured using an Easy Latch
- The gate will automatically self close. From fully open in approximately 3 seconds using the offset self-closing hinges

Features

- Access for pedestrians
- Access for horse riders
- Overall installed height - 1900mm
- Overall post to post - 1925mm
- Gate leaf - 1570mm wide x 1870mm high

1.2m Woodstock Railed Hoops Self Closing



- Railed hoops
- Integral H frame posts
- Wheelchair access

Deer Kissing Gate



Galvanised steel hoops, H-Frame, strengthening bar gate with self closing gate system.

Circular hoops give easy access for pedestrians. H-Frame and strengthening bar provide rigidity and ease of installation. Height and appearance make it suitable for both forestry and parkland situations.

3.66m Bristol 2 in 1 Combination Gates

RW40



Bristol 2 in 1 gate allows pedestrians to be able to pass through the self-closing step gate, the field gate can remain closed or even locked if required.

STANDARD HAND GATE



OPPOSITE HAND GATE

Please note - this item is made to order



Hingeless Barrier Gate



Offering all security features of a rectangular or triangular barrier gate, manufactured from 100 x 50 RHS but with the addition of 'hingeless' opening system making the gate less susceptible to vandalism.

Heavy Duty Triangular Vehicle Barrier



Manufactured from 100mm x 50mm RHS and hot dipped galvanised after manufacture.

The PADDOCK SECURITY BOX system is incorporated into the slam post thus allowing the barrier to be used either left or right handed.

Motorbike Inhibitors

RW45



Two galvanised tubular panels partly sheeted.

This design has been tested and proved to inhibit motorbikes whilst allowing access to pedestrians and users of most sizes of mobility vehicles.

It is recommended that local users and disabled ramblers are consulted about the siting and the gap that is most suited to them. All mobility users require a level and hard surface through the barrier.

Also available: Polyester Powder Coated in Moss Green or Black.

Have You Seen?



Our DURA² Fencing range.

DURA² is the patented production process which is sustainable, environmentally friendly, and the cost effective alternative to creosoted timber.

See page 36 and 37

Milton Keynes Bridle Gate



- 1.0m - Height 1.0m-1.1m, width post to post 1.3m, gate leaf 1.0m
- 1.2m - Height 1.0m-1.1m, width post to post 1.5m, gate leaf 1.2m

Size	Code
1000mm	RW100
1200mm	RW105

Milton Keynes Bridle Gate (2 way)



- RW14
- Clad with 50x50mm mesh
 - Galvanised to BSEN ISO 1461
 - Integral H frame for easy erection
 - Opens in either direction

Henley Bridle Gate



- Available as two or one-way
- Stockproof handle option available
- Complies with BS5709:2018 specs

1 Way Self Close Stratford Gate



- RW110
- Height - 1.0m
 - Width to post - 0.95m
 - Gate leaf - 0.7m

Aston Bridle Gate



- Extra strong design suitable for all users
- Trombone handle (standard) provides easier access
- Stockproof handle also available as an option

Chiltern 1.5m Bridle Gate 2 Way

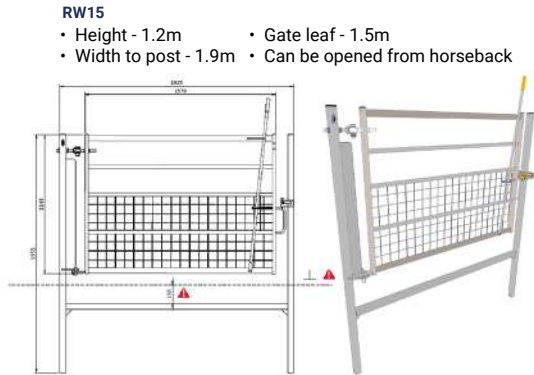

- RW15
- Height - 1.2m
 - Width to post - 1.9m
 - Gate leaf - 1.5m
 - Can be opened from horseback

Stiles



Wooden Stile Kit

- WG900
- A traditional two step stile kit with posts rails and steps
 - 1.2m wide
 - Manufactured from treated softwood

Stile sizes & details available online

Cattle Grids

IAE ATV FieldLink TCSATVE



Improve on farm efficiency with IAE's FIELDLINK, designed to eradicate the need for the continuous opening and closing of gates whilst keeping livestock in their desired fields.

Drop In Style Cattle Grid

Cattle grids, drop-in style, enables the grid to be installed very quickly with no requirements for concreting during installation.

Various sizes and weights available to control sheep, cattle and deer, all made to BS4008:2006.



All drop in grids are hedgehog friendly with an exit ramp fitted as standard.

Hopkins Cattle Grids

- Hopkins are the original creators of the Quick-Fit Cattle & Deer Grid System
- BRITISH MADE
- Depth of grid 14"/ 355mm
- Ideal for Farm, Estate or Forestry roads or Highways
- All Steelwork Galvanised to BS EN ISO 1461:2022 which supersedes BS EN ISO 1461:2009.
- Supplied with optional and removable stock proof side rails.
- Fast delivery times

Also available the *Traditional Tubular style grid* and *The Additional Protection grid*, suitable for those with sheep or goats, available in 26 ton and 50 ton.

- 5T Grid - 3T Max Axle Loading (x Standard Cattle Jump 2.69m)
- 26T Grid - 6.5T Max Axle Loading (x Standard Cattle Jump 2.69m)
- 50T Grid - 11.5T Max Axle Loading (x Standard Cattle Jump 2.69m)
- 50T Grid - 11.5T Max Axle Loading (x Standard Deer Jump 4.65m)
- 196T Grid - Standard BS EN Loadings Highway use (x Standard Cattle Jump 2.69m)

FOR FULL DETAILS OF HOPKINS CATTLE GRIDS VIEW ONLINE



Download, read and use the complete Hopkins installation guide

















Metal Gate fittings

We select our stock for quality and suitability for purpose, so you can be sure that our fittings will withstand the test of time, as well as any livestock pressures! All of our fittings are fully galvanised to the expected British standards.

Use the following gate fittings menu to find the parts you need
Click the links below (if active) to direct you to our live product pages.

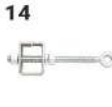















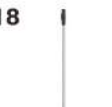













Hanging Gate fittings

 1 Hinge Set C/W Adjustable Bottom Hinge	 2 Hinge Set on Square Plates	 3 90° SC/Rising Hinge Set	 4 180° Rising Hinge Set	 5 Adjustable Hook and Band	 6 Medium Tee Hinges
 7 Hinge Hook to Bolt	 8 Hinge Hook to Bolt with Lock Leg	 9 Hinge Hook to Drive	 10 Hinge Hook on Square Plate	 11 Hinge Hook on Vertical Plate	 12 Adjustable Hook On Plate
 13 Adjustable RSJ Hanger	 14 Adjustable Bottom Hinge C/W Cups	 15 Adjustable Gate Eye			

Closing Gate fittings (Metal Gates)

 1 Auto Catch Large	 2 Retro Fit D-Loop	 3 Loop Bolt Receiver on Drilled Plate	 4 Padlockable Heavy Duty Throw Over Frame	 5 Throw Over Loop-Lift N Slide Frame	 6 Simple Throw Over Frame
 7 Bolt on Drop Bolt	 8 Clamp on Drop Bolt	 9 Bolt on Wheel T/S Metal Gate	 10 Bolt on Spring Loaded Wheel Support		

Closing Gate fittings (Wooden Gates)

 11 Cranked Striker	 12 Double Leg 'D' Striker	 13 Gate Staples	 14 Unilatch Gate Kit (METAL)	 15 Unilatch Gate Kit (WOODEN)	 16 Unilatch 2-Way S/Lock GT Catch
 17 Unilatch Trombone Handle	 18 Unilatch Straight Handle	 19 Auto Catch C/W Striker	 20 Animal Friendly Auto Catch C/W D Striker	 21 Spring Catch Set	 22 Central Closing Catch
 23 Hasp & Staple	 24 Spring Loaded Bolt	 25 Brenton Bolt	 26 Cabin Hook	 27 Safety Hook and Eye	 28 Suffolk Latch
 29 Ring Gate Latch	 30 Long Throw Lock	 31 Throw Over Frame	 32 Padlockable Throw Over	 33 Monkey Tail Bolt	 34 Garage Drop Bolt
 35 Padlockable Garage Drop Bolt	 36 Kick Over Gate Catch	 37 Gate Return Springs	 38 Slip Rail Brackets	 39 NZ Chain	 40 Northumberland Gate Chain
 41 Gravity Catch To Fix In Concrete	 42 Anti Theft Collar				

Click link to view full gate fittings range



Farming

Quick Chapter Links



mcveighparker.com

From drinkers to silage wrap, we've got you covered.



Harvest

We are proud to bring you the very best brands of harvest products all at excellent prices. From Visqueen silage sheets to Cordex twines, net and stretch wrap, we have everything you'll need to help make your harvest run smoothly.



Livestock Handling

We stock a huge range of farming supplies from sheep trailers to cattle crushes, feeder to races. Whether you're weighing or EID reading, crutching or daggging we have a solution to suit your requirements.

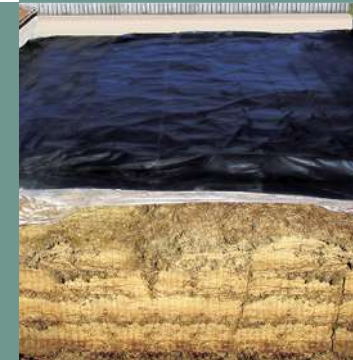

Stokbord

For a more environmentally friendly alternative to ply, our range of Stokbord recycled plastic sheets offer you a long lasting and hygienic sheet. It is extremely flexible, robust and maintenance free, making it great for poultry and livestock housing and races.

Drinking Troughs



We stock a huge range of water troughs in a selection of materials, sizes and profiles to suit your needs, available to buy as standalone troughs, or complete kits.



Cattle Equipment



From individual to modular systems that help you as you grow your herd, we have all you need, including feeders, cattle handling systems, crushes, calf equipment and a made to measure service available.



Click link above for CLIPLEX catalogue

We are a one stop shop for a huge range of farming supplies including livestock handling equipment, feeders, drinking troughs, Stokbord and harvest products to name just a few.



Leading Stockist

Sheep Equipment



From weighing products and feeders to sheep hurdles and races we have everything you need to help make sheep handling easier. We stock leading brands like IAE, CLIPLEX and WM Ironwork as well as an array of bespoke solutions to specifically meet your requirements.



Click link above for IAE brochure

To view the complete McVeigh Parker farming product range simply click the link to the right. ▶

Or use the following URL:
www.mcveighparker.com/farming



Cattle Crushes & Handling Equipment

Our cattle crush and handling range includes modular cattle handling systems that allow you to grow your cattle system with your herd and is suited to a variety of cattle breeds

British Made Cattle Crushes *Over Seven Designs To Choose From*



Tamar Squeeze Handling Trailer TC42000



- 7340mm (inc draw bar) (L) x 2050mm (inc tyres) (W)
- All galvanised to BSEN ISO 1461

Super Scoop MK 4.5 TC41910



- Restricts the side to side movement of the animal's head
- Provides increased safety for the animal and the operator
- Takes the strain out of tasks such as dosing and ear tagging
- Suitable for a range of IAE crushes

Calving Hurdle Deluxe TC3250



- Easy access for suckling calf
- Yoke to hold animal in place
- Removable rails

IAE Rotex Bespoke5



- Superbly convenient portable cattle handling system
- Extremely portable, quickly assembled, and safe
- Semi-circular layout for animal welfare and operative safety



Cattle Feeders

Diagonal Feed Fence Panel TC1420



- A well proven feeding system which prevents floor wastage and bullying
- Available with or without timber base
- 4420mm long x 915mm high
- Gate option available on request

Portable Diagonal Feed Fence Panel (2 in 1 Unit) TC1120



- Panel length options: 3050mm & 4075mm
- Finished height 1375mm
- Option 610mm wide x 345mm deep steel feed trough
- Option 790mm wide x 405mm deep steel feed trough

Cattle Feed Trough TC6110



- 2740mm (L)
- 420mm (W)
- 190mm (D)

Bullock Trough Heavy Duty - Galvanised TC6100



- Fully welded for all feed types
- Floor feeding trough with excellent stability
- Heavily galvanised to BSEN ISO1461

Cattle Feed Ring TC2110



- Manufactured in two sections bolted together
- Durable, tough and resilient

Size	Code
Yearling: 1600mm dia. 1145mm (H)	TC2140
Standard: 2135mm dia. 1295mm (H)	TC2110
Heavy Duty: 2135mm dia. 1450mm (H)	TC2120

Heavy Duty Tombstone Feeder TC2150



- 2285mm diameter x 1150mm (H) x 670mm deep welded base
- 12 feed spaces
- Also suitable for horses

Low Level Beef Trough on Legs & Badger Defence Kit TC6140



- 2440mm (L)
- 786mm (W)
- 230mm (D)
- 915mm legs
- Badger proof

Feed troughs can also be purchased without the badger defence kit

Calf De-Horner Crate - Large TC8200



- 1185mm x (L) 480mm (W) x 1195mm (H)
- Full access to rear of animal
- Easy to move with wheels and handle fitted

Portable Cattle Handling System

- Strong yet easy to move
- Suitable for yard or field use

Because of the modular design of our Galvanised Portable Cattle Handling System, it is easy to tailor make a system to perfectly suit your own requirements. All items are quick and easy to assemble.

Suitable for both yard and field use (may require some permanent fixtures in a yard).

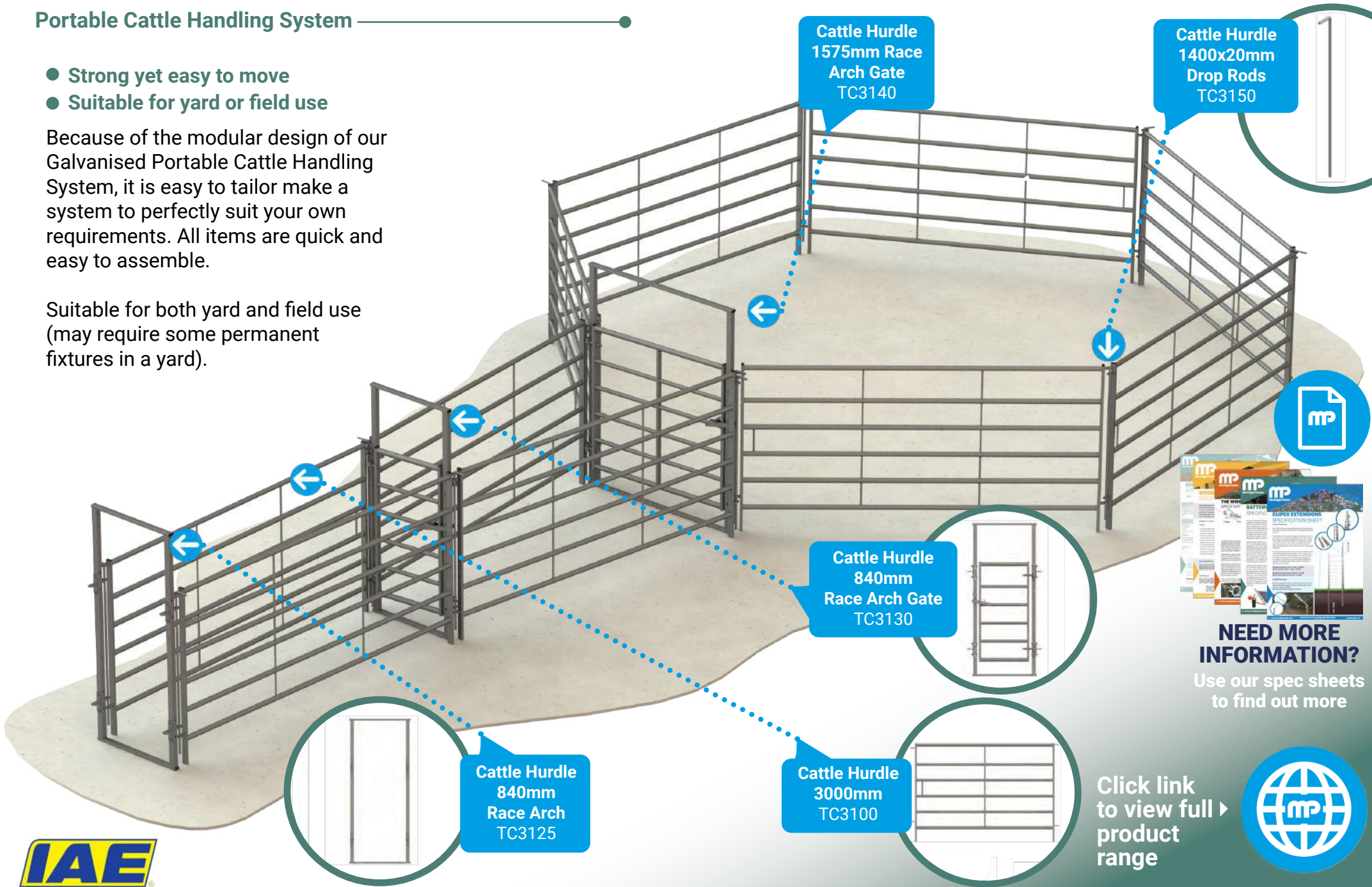

NEED MORE INFORMATION?

Use our spec sheets to find out more

Click link to view full product range



Sheep Equipment

Our sheep handling range is designed and manufactured to make day-to-day handling of livestock more straightforward. Our comprehensive range includes sheep handling products like hurdles, sheep races, handling crates, weighers and footbaths.

Sheep Hurdles

Interlocking Sheep Hurdles



- 970mm (3ft) tall
- Interlocking for stability
- Looped ends allow for easy connecting

Size	Code
1200mm	TS1110
1500mm	TS1119
1800mm	TS1120
2400mm	TS1130

Interlocking Half Mesh Hurdles

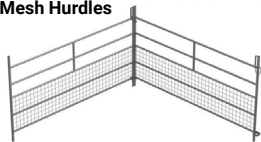

- 1050mm high half meshed sheep hurdles
- Available in 1.2m or 1.8m lengths
- Easily combined to create runs and pens

Size	Code
1200mm	TS1230
1800mm	TS1350

Lamb Creep Hurdle

TS1310

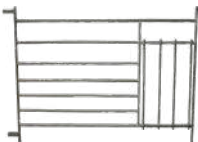

- 1830mm x 970mm high
- 7 horizontal rails
- Loop type coupling, compatible with interlocking hurdles

Sheep Feeders

Sheep Hayrack on Wheels



- Double sided 76mm x 76mm hayrack
- New and improved design
- Suitable for small livestock and Alpacas
- Supplied with 4 x 254mm wheels x 25mm bore with rubber tyre
- 799mm wide lid with a Protex fastening and lid catch
- 600mm wide x 813mm high

Size	Code
1200mm	TS3215
2400mm	TS3210
3000mm	TS3200

Lamb Creep Feeder



- 460mm (W), 650mm (H), 728mm wide lid
- Unique easy exit up ladder designed to reduce head trapping

1.2m feeder

- 12 feed spaces (designed to feed approx. 20)
- 1250mm long
- 117L capacity

2.4m feeder

- 24 feed spaces (designed to feed approx. 35)
- 2440mm long
- 234L capacity

Size	Code
1200mm	TS3110
2400mm	TS3335

Double Sided Hay Feeder Basket

TS1100



- 475mm x 475mm x 490mm
- 75mm x 75mm mesh
- Holds at least 2 slices of hay from a small bale

Sheep Feed Ring

TS2110



- Suitable for sheep, lambs and alpacas
- 24 feed spaces
- For inside or outside use

Sheep Feed Trough



- A quality sheep trough of rigid construction
- Suitable for sheep, alpacas, goats, ponies, pigs and deer

Size	Code
900mm	WT403
1830mm	TS4130
2745mm	TS4140

Hook on available for 900mm & 1830mm size



Click link to view full farming product range

Hook over Sheep Hayrack

TS4300



- 75mm x 75mm weldmesh
- Sheeted end panels
- Hook brackets welded on

Size	Code
600mm	TS4295
915mm	TS4300
1250mm	TS4305
1830mm	TS4320

Ewe-Turnover Crate

TS7100



- Ease of operation for left or right handling with 2 height options
- Fully galvanised to BSEN ISO 1461
- 1600mm long x 820mm wide x 1100mm high

Hook on Sheep Trough



- 284mm wide x 123mm deep
- Ideal trough for calf or sheep pens when housed
- A portable feeding solution

Size	Code
915mm	TS4200
1370mm	TS4230
1830mm	TS4240

Sheep Race System D

- Approximately 15m long x 5.1m wide
- All galvanised to BSEN ISO 1461

Sheep System D is the corner stone of a very versatile system, utilising a 4.88m x 8.6m long approx semi circular forcing pen.

Capable of holding 40 - 60 breeding ewes.

Sheep System D Plus builds on this to provide additional holding for one hundred head.

Other size systems available

All products can purchased separately

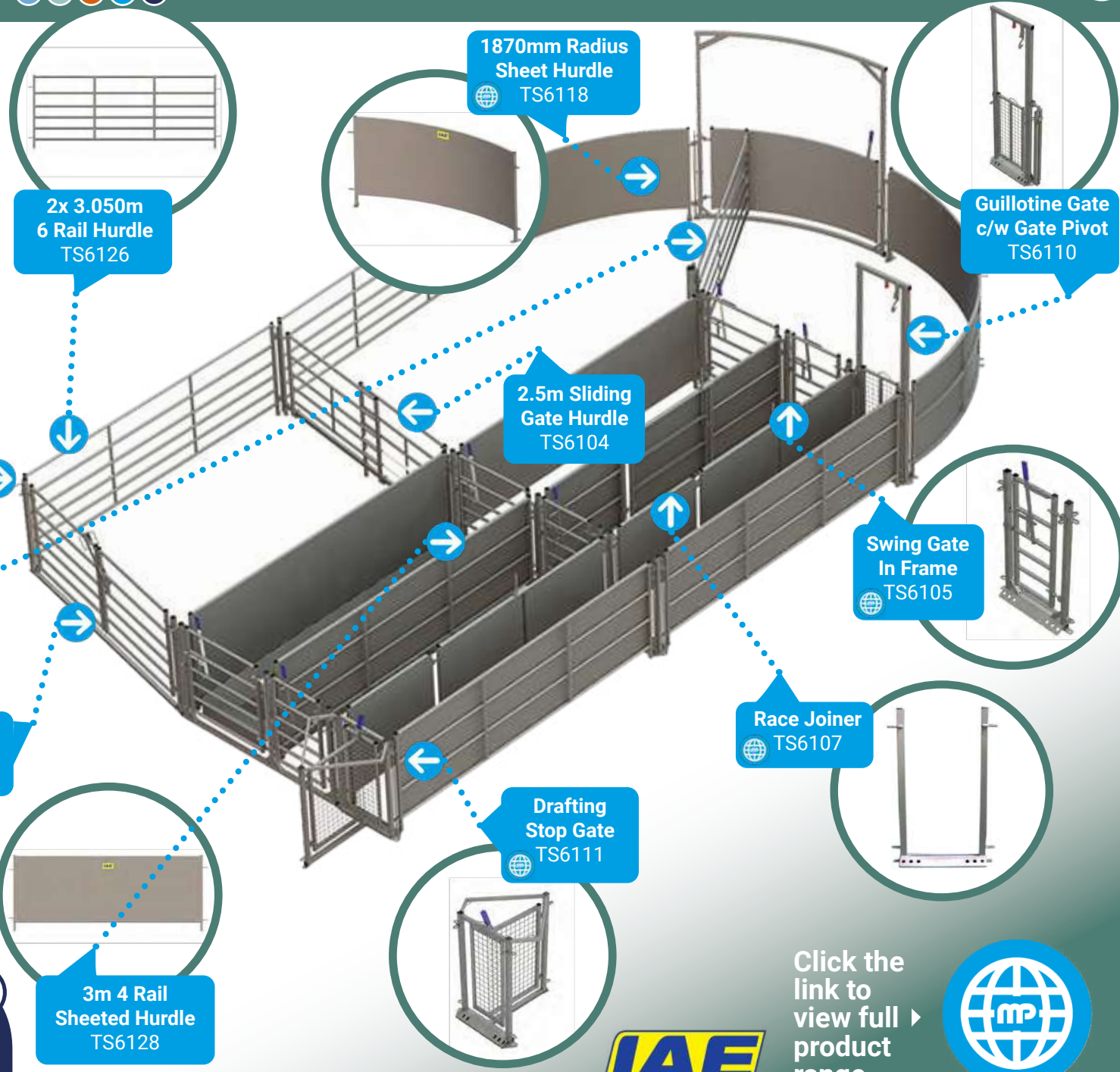

Coupling Rods TS6108



Swing / Slide Gate TS6116

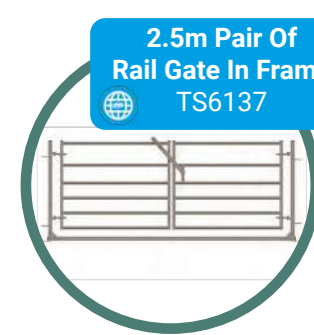

2.5m Pair Of Rail Gate In Frame TS6137

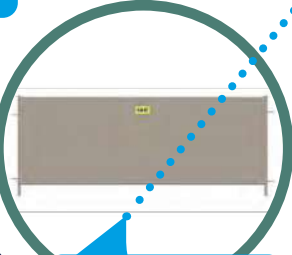

3m 4 Rail Sheeted Hurdle TS6128



Drafting Stop Gate TS6111



Race Joiner TS6107



Swing Gate In Frame TS6105



Guillotine Gate c/w Gate Pivot TS6110

Did You Know?



We also supply mobile sheep races, wheeled sheep handlers, weighing and EID equipment from leading manufacturers. On site design and advice service available, contact us now.

Click the link to view full product range



Plastic Water Troughs

A plastic water trough is the perfect solution. Light, but strong and resistant, our plastic water troughs are easy to clean and transport. We have a variety of portable yet durable troughs available. Choose from fast-fill, single or double troughs in a variety of sizes. All plastics are frost-proof, UV protected and can withstand extreme climates, so are suitable for indoor or outdoor use. Perfect for horses, sheep, cattle and most other livestock, our water troughs are the ideal solution for your farm or field.

Plastic Water Troughs

JFC 15 Gallon Water Trough
JFCDT15



- 700 x 475 x 310mm
- Capacity 15 gallons / 68 litres
- Overflow 81 litres
- Fitted with a fast-flow valve (up to 34L/min @ 2bar pressure)

All water troughs fitted with a fast fill ball valve

JFC 30 Gallon Easy Access Trough
JFCDT30



- 1250 x 475 x 310mm
- Easily moved from site to site
- Fitted with 2 drain offs for easy emptying and cleaning
- Fitted with a fast-flow valve (up to 41L/min @ 3 bar pressure)



JFC 450 Gallon Round Water Trough
JFCDT450



- 2130 x 830mm
- Ideal for large groups of cattle
- Light and easy to move
- Drain plug fitted for easy emptying
- Fitted with a fast-flow valve (up to 41L/min @ 3 bar pressure)

JFC Thermal Drinker
WOJFCTHERMALDRINKER



- Capacity - 20L
- 490mm D x 500mm W x 460mm H
- Prevents water freezing during winter months

JFC Micro Bowl Drinker
JFCDBL4



- Dimensions 330 x 254 x 228mm
- 4 litres (0.9 gallons)
- Float valve & stainless steel protection cover
- 50mm drain off plug

JFC Conventional Drink Bowl
JFCDBL



- Dimensions: 395 x 400 x 340mm
- 16 litres (3.5 gallons)
- Fitted with a 1/2" brass valve
- Built in drain plug

Click the link to view full product range



Do You Need Our Advice?

Stuck with a particular part of a project and need advice? Then feel free to get in contact and our helpful staff will endeavour to help you.

JFC Fast Fill Water Trough Key Features

- Fitted with a fast-flow valve (up to 41L/min @ 3 bar pressure).
- Valve protected with a polyethylene compartment with easy access.
- Thick walls for greater strength and durability.
- High freeze / thaw cracking resistance.

JFC Double Reservoir Fast Fill Water Trough



Capacity	Dimensions (mm)
68L / 15 Gal	700D x 475W x 310H
136L / 30 Gal	1250D x 475W x 310H
400L / 88 Gal	1550D x 730W x 530H

JFC Oval Fast Fill Water Trough



Capacity	Dimensions (mm)
450L / 100 Gal	1550D x 990W x 685H
600L / 130 Gal	1610D x 1180W x 840H
800L / 175 Gal	1970D x 1180W x 840H
1000L / 220 Gal	2180D x 1180W x 840H

Tapered sides to reduce badger access.

JFC Circular Fast Fill Water Trough



Capacity	Dimensions (mm)
871L / 190 Gal	1540 Ø x 675H
1125L / 248 Gal	1725 Ø x 600H
1590L / 350 Gal	1590 Ø x 750H
1590L / 350 Gal	1590 Ø x 750H

Tapered sides to reduce badger access.

Do you know the drinking water requirements for your livestock?

These figures are guides only as individual requirements will vary depending on individual circumstances, environment and diet.



Cattle

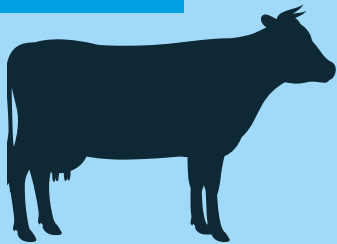

50L LITRES/DAY
COW WITH CALF



68-155L LITRES/DAY
DAIRY COW

Pigs

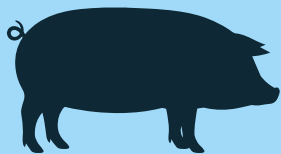

18-23L LITRES/DAY
LACTATING SOW



13-18L LITRES/DAY
GESTATING SOW/BOAR

Sheep

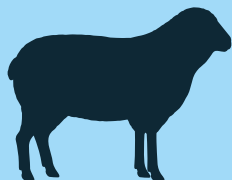

9-10.5L LITRES/DAY
EWE WITH LAMB



4-6.5L LITRES/DAY
PREGNANT EWE / RAM

SOURCE: DAERA.GOV.UK

Our drinking troughs are suitable for cattle, sheep, horses, alpacas and many other species. We have steel drinking troughs, plastic water troughs, universal drinkers and bowls, trough accessories and pumps.

Steel Water Troughs

Steel Livestock Water Trough

- 457mm wide x 405mm deep
- Includes 10mm drain plug & bung
- Manufactured from 1.5mm flat steel
- 30mm roll top for added strength and stability



405mm trough height

Length	Capacity	Weight	Code
600mm (2ft)	109ltr (24 gallons)	18.65kg	WT02
915mm (3ft)	163ltr (36 gallons)	24.80kg	WT03
1220mm (4ft)	218ltr (48 gallons)	30.95kg	WT04
1525mm (5ft)	272ltr (60 gallons)	37.08kg	WT05
1830mm (6ft)	327ltr (72 gallons)	43.76kg	WT06
2440mm (8ft)	436ltr (96 gallons)	56.82kg	WT08

Large Steel Livestock Water Trough

- 610mm wide x 610mm deep
- Includes 10mm drain plug & bung
- Manufactured from 1.6mm flat steel
- 30mm roll top for added strength and stability



600mm trough height

Length	Capacity	Weight	Code
1220mm (4ft)	454ltr (100 gallons)	47.51kg	WT204
1830mm (6ft)	681ltr (150 gallons)	65.94kg	WT206
2440mm (8ft)	980ltr (200 gallons)	84.38kg	WT208
3050mm (10ft)	1135ltr (250 gallons)	99.91kg	WT210

Steel Sheep Water Trough

- 457mm wide x 267mm deep
- Includes 10mm drain plug & bung
- Manufactured from 1.5mm flat steel
- 30mm roll top for added strength and stability



267mm trough height

Length	Capacity	Weight	Code
915mm (3ft)	102ltr (22.5 gallons)	19.84kg	WT403
1220mm (4ft)	136ltr (30 gallons)	24.94kg	WT404
1830mm (6ft)	204ltr (45 gallons)	35.59kg	WT406
2440mm (8ft)	272ltr (60 gallons)	46.23kg	WT408

Large Capacity Water Trough

- 1200mm wide x 610mm deep
- Includes 24mm drain plug & bung
- Manufactured from 2.0mm flat steel
- 30mm roll top for added strength and stability
- Fully welded integral service box (ball valve housing)



600mm trough height

Length	Capacity	Weight	Code
3050mm (10ft)	2270ltr (500 gallons)	194.54kg	WT302
3660mm (12ft)	2724ltr (600 gallons)	227.82kg	WT304

Please note - All steel troughs are welded and then fully galvanized to BSEN ISO 1461 | WRAS Compliant

Disclaimer: Tolerances + or - 2%, please check at time of ordering if measurement is crucial

Calf & Lamb Rearing, Footbaths, Dipping Tanks

Milk Kart with Mixer

JFC MK170MP-3

- 1.5" lever valve allows user to control the amount dispensed
- Twist on lid minimises spillages and contamination
- Galvanised steel frame and dispensing nozzle
- Kart, motorised mixer and pump all available as separate items or as a combination
- Upgraded braked castor swivel wheels allow smooth manoeuvrability



10 Teat Calf / Lamb Feeder

- Designed with 2 reinforced hangers for mounting on a gate, rail or fence.
- Fitted with 2 hooks to provide extra security.
- Designed with minimum crevices making them easy to clean.
- An efficient way of delivering milk to 10 calves at once.
- The teats encourage a natural sucking action allowing milk to be delivered at an optimum rate.
- 22mm bored hole for fitting.



Calf Hutches

- No planning permission required.
- Easy to clean and disinfect, providing a hygienic environment for the calf.
- Strong, durable and weather resistant.
- Adjustable roof vent for ventilation.
- Lightweight and easy to handle.
- A cost effective and versatile alternative to permanent shed/buildings.



JFC Ribbed Cattle Footbath

JFCFB4

- Heavy duty, easy to clean plastic
- Helps reduce the spread of infection
- Profiled base opens hooves for extra penetration of solution



Sheep / Calf Drinking Trough

JFCDBL2

- Fitted with 1/2" brass valve, capable of up to 5L/min at 3 bar pressure (1/2" connection).
- Refills in 6 minutes at 3 bar pressure.
- Narrow double reservoir for placement between two areas giving several animals simultaneous access to water.
- Supplied with 2 stainless steel mounting brackets.
- Manufactured from tough and frost resistant polyethylene.



Large Gate / Fence Feed Trough

JFCGFT 1

- Designed with 2 reinforced hangers for mounting on a gate, rail or fence.
- Fitted with 2 hooks to provide extra security and to prevent calves from knocking the feeder.
- Rounded edge design ensures animal safety.
- Finished with a smooth seamless coat to reduce feed build up and for ease of cleaning.
- Can be stacked to save space.
- Easy to transport



Sheep Footbath (Smooth) 1540x570x140mm

JFCFB1

- Manufactured from tough polyethylene making them extremely hard wearing and durable.
- Smooth base is effective in the treatment of claw/hof diseases including interdigital dermatitis.
- Built in safety ribs to prevent slipping.
- Designed with a turned in lip which significantly reduces the amount of solution wasted due to spillages.



Sheep Dipping Tank

JFC SD250

- Ground installation
- 136 Litres / 250 Gallons
- 108" (length) x 37" (width) x 48" (height)
- Sheep dipping tub with stepped exit
- Manufactured from tough, impact resistant and UV protected polyethylene
- Smooth edges for animal safety.
- Versatile tank for dipping or bathing sheep in disinfectant solution.
- Designed for installation in the ground with a stepped exit for smooth passage



Pasture Pumps

Aquamat II Pasture Pump Kit

KPP



- Ideal for cattle and horses
- Protects river banks and water courses
- Low cost solution for those without mains water or in catchment sensitive areas

Features

- 1 x Aquamat Nose pump Mk II
- 1 x Filter basket
- 7m of reinforced flexible hose
- Can supply 15-20 head of cattle
- Protects river banks and water courses
- Rust and UV resistant
- Quick installation time, approx. 20 mins
- No power is required to operate
- Tough polypropylene trough and steel mechanism
- Provides 7 metres vertical lift or 70 metres horizontal lift
- Dispenses 0.5L with each pump lever action
- Trough capacity 1 litre

Rough installation drawings

A. Traditional water source extraction

B. Using underground water source

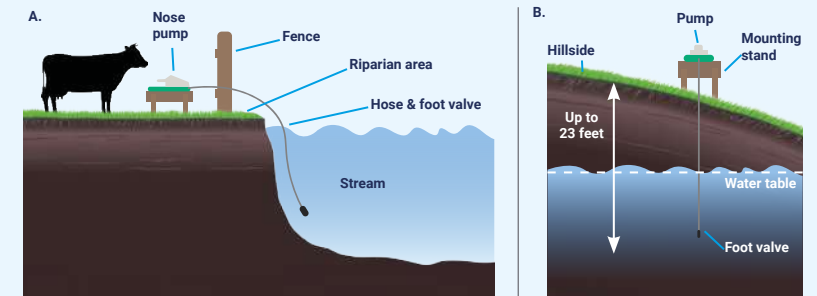

Battery and Solar Water Pump SOLAR WATER PUMP

- Durable, weather-proof, polypropylene
- Holds up to 86 amp hour (12V) batteries
- Supplied with 30m hose and 30m cable

Kit includes

- Control box and battery compartment
- 60w solar panel and stand
- 30m hose
- Submersible pump
- With 30m cable

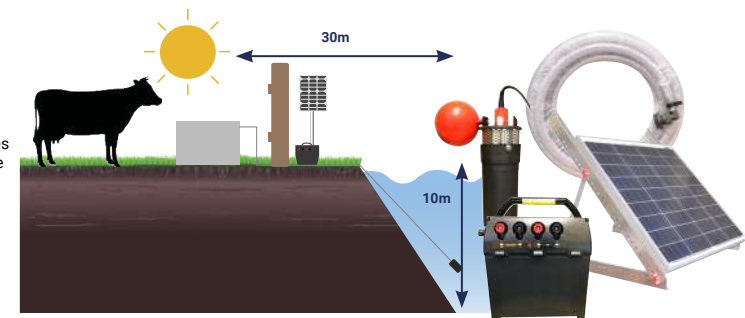

Concrete Water Troughs & Supports



Concrete Troughs

- Product only stocked in our Devon depot
- Available in 6 sizes
- Special delivery terms - ask for a quote



Concrete Trough Supports

- Suits our 457mm & 600mm wide steel water troughs
- Effectively supports the water trough
- Raises the trough to the ideal drinking height

Available in two widths (460mm & 600mm)

Harvest Products

We stock Twine / Netwrap / Stretch Wrap / Silage Sheets / Clingseal for all your spring harvest wrapping requirements.

Stretchwrap

- Renowned for unrivalled performance
- Reliable, strong and durable with consistent quality
- High track level and long life ensures trouble-free wrapping
- Suitable for round and square bales
- Excellent protection during long winter months of storage
- Highly recommended 6 layers used



Width (mm)	Length (m)	Thickness	Rolls (per pallet)
750	1500	25um	40
500	1800	25um	48
250	1800	25um	64



- 30% more silage bales and no box
- Suitable for round baling
- Contractors tool to save you time and money



Width (mm)	Length (m)	Thickness	Rolls (per pallet)
750	1800	20um	40

Netwrap



Width (mm)	Length (m)	Roll weight	Breaking strength	Pallet size
1230	3600	34.5kg	265kg - 270kg	28



• Net replacement film **BALETITE**

Width (mm)	Length (m)	Micron	Rolls per pallet
1280	1650	20	20
1380	2000	16	20



Crop	Bale size	No. of turns	Round bales (per roll)
Hay	1.2m Ø	2-3	330 - 300
	1.5m Ø	2 - 2.25	250 - 225
Silage	1.2m Ø	2.25 - 2.75	295 - 240
Straw	1.5m Ø	2 - 2.25	250 - 225

Silage Nets, Tape & Bags

Product	Sizes (m)	Rolls (per pack)
Silage protection nets	8m x 25m	1
Tape	75mm x 33m	48
Tape	100mm x 33m	24
Patches	220 per roll	24
Silage bags	2.235m x 3.054m x 100um	10



Twine

Not sure which grade twine you need for this year's crop?

Use the helpful guide below and get this year's harvest in with ease.



International Baler Twine Segmentation



EXTREME

For High Density balers where ultimate performance is required. Use it for straw in conditions of extreme density or high temperatures, short straw and corn stalks.

VERY HIGH

Specially designed for use in balers in the 'EXTRA' high density sector, or when baling in more extreme conditions - high temperatures, low humidity or making bales of extreme density.

HIGH (Equivalent to Type 130)

The best performing option for all crops and balers where high density is required. Use it for silage and for high density hay and straw bales.



STANDARD

A standard big bale twine, suitable for use in all crops and normal baling conditions.

LOW

A twine suitable for use in any big baler, where only the lowest bale density is required, which also gives maximum spool length.

Recommended Wrap Guide

LOW	STANDARD	HIGH	VERY HIGH	EXTREME
	Equivalent to Type 150	Equivalent to Type 130		Impax UHD Impax HD
Tama LSB Max	Tama LSB Long	Tama LSB Power	Tama HD Extra	Tama HD Prime
		Tama LSB Power XL	Tama HD Extra XL	Tama HD Prime XL

Silage Sheets

All our sheets are manufactured using new techniques and improved raw polymer granules. This process is known for high strength, puncture resistance and excellent seal characteristics.

The innovative combination of Visqueen Agri-S and Visqueen Clingseal - a thin, flexible, low permeability sheet helps to create the right anaerobic conditions for fast, efficient fermentation.

In doing so it prevents pockets of trapped air forming to significantly reduce aerobic spoilage on the top and shoulders.

- Reduces air pockets
- Reduces losses in the clamp
- Facilitates a more efficient fermentation
- 100% recyclable



Sizes (m)	Weight (kg)
Visqueen Agri-S Standard	
4 x 50	19.1kg
8 x 25	19.2kg
8 x 50	38.5kg
11 x 25	26.3kg
12.8 x 36	44kg
11 x 42	44.1kg
14 x 30	40.3kg
16 x 30	45.9kg
16 x 40	61kg
18.3 x 25	43.5kg
Visqueen Agri-S Double Strength	
4 x 25	19kg
8 x 28	42.8kg
11 x 28	47.1kg
Visqueen Clingseal	
8 x 50	Thickness 40 microns
12 x 50	
16 x 50	

CLINGSEAL WHY GAMBLE?



CLINGSEAL & VISQUEEN SHEETS BETTER TOGETHER

Storage Tanks

Domestic & commercial



Single Skin Tanks

Constructed with the same high quality and care as Bunded Oil Storage Tanks, our Single Skin Storage is better suited for domestic usage. Available in various profiles and sizes.



Water Storage

Suitable for potable water storage and non potable rain water harvesting. Our selection of water tanks can hold up to 10,000 litres (2200 gallons).

Supplied with a two year manufacturer's guarantee.



Treatment Tanks

We can supply various off-mains drainage products and solutions to the domestic, civils/ commercial, agricultural and leisure sectors. If you are looking for a sewage treatment plant, grease trap, storm attenuation, septic conversion tanks, we have the answer. Made in the UK. On site surveys and advice available.

Bunded Oil Storage

Avoid large fines for spillage by conforming with a bunded tank. Deso tanks comply with the latest European standards and provide cost effective solutions to domestic, commercial and agricultural storage and dispensing requirements. Supplied with a 10 year manufacturer's guarantee.



Fuel Dispensers

Designed for easy access, our Fuel Dispensers are easy to install and come with the knowledge that they conform with latest regulations. Our range includes portable options and capacity varies from 430 to 5000 litres.

We stock a full range of storage tanks for both domestic and commercial use including; bunded oil storage, fuel dispensers, single skin tanks, water storage and sewage treatment plants/ septic tanks.



Fuel Dispenser Pumps

Make your fuel delivery easier with a fuel pump station. Battery or mains available. The system contains a number of features, such as floatation gauge, particulate filter, auto shut off nozzle. Optional extras, longer hose and flow meter are available.



To view the complete McVeigh Parker storage tank product range simply click the link to the right. ▶

Or use the following URL:
www.mcveighparker.com/storage-tanks



Bunded Oil Storage



Slim Line 1000 Litres (220 gallons)
OTD1005G



- Length: 1890mm (6' 3")
- Width: 645mm (2' 1")
- Height: 1340mm (4' 5")

Vertical 1340 Litres (295 gallons)
OTD1010G



- Width: 1410mm (4' 8")
- Height: 1531mm (4' 11")
- Footprint: 1390mm (4' 7")

Slim Line 1400 Litres (308 gallons)
OTD1007G



- Length: 2140mm (6' 11")
- Width: 660mm (2' 1")
- Height: 1695mm (5' 5")

1800 Litres (396 gallons)
OTD1013G



- Length: 1970mm (6' 4")
- Width: 1350mm (4' 4")
- Height: 1510mm (4' 9")

V2455 Litres (540 gallons)
OTD1015G



- Width: 1700mm
- Height: 1730mm
- Footprint: 1670mm (5' 6")

2500 Litres (550 gallons)
OTD1025G



- Length: 2300mm (7' 5")
- Width: 1250mm (4' 1")
- Height: 1450mm (4' 7")

V3500 Litres (770 gallons)
OTD1018G



- Width: 2120mm (4' 1")
- Height: 1600mm (5' 3")
- Footprint: 2075mm (6' 10")

Oil Tank Filter Assembly Kit
OTD2005



This filter assembly kit is a filter designed for heating oil tanks. The kit comes complete with everything that is required to quickly and simply install it.

- Oil filter complete with isolation valve
- 1" M BSPT x 1/2" M BSP conical fitting
- PTFE Tape
- Plastic pipe insert

Sonic Oil Level Monitor
OTD2000



The Kingspan Watchman Sonic Advanced is a revolutionary electronic measuring gauge that monitors how much oil there is left in your oil tank and sets off an alarm in your home in the event of a sudden drop in oil levels. This helps you to ensure that you never run out of oil.

- Optional upgrade to Watchman SENSIT, allowing you to get oil level notifications directly to your phone.
- One model fits all
- Quick and easy to install
- Audible alarm when oil levels run out
- Low power consumption

Use our spec sheets to find out more



Single Skin Tanks

Our single skin tanks are ideal for domestic or small scale fuel storage

Slim Line 1220 Litres (268 gallons)
OTD1000



- Length: 2060mm (6' 9")
- Width: 660mm (2' 2")
- Height: 1120mm (3' 6")

1900 Litres (417 gallons)
OTD1290



- Length: 1850mm (6')
- Width: 1240mm (4' 1")
- Height: 1340mm (4' 5")

2500 Litres (550 gallons)
OTD1300



- Length: 1850mm (6')
- Width: 1240mm (4' 1")
- Height: 1340mm (4' 3")

Fuel Dispensers

Contract V1340 Litres (294 gallons)
OTD1043



- Diameter: 1390mm (4' 5")
- Height: 1740mm (5' 7")

Contract V2350 Litres (516 gallons)
OTD1046



- Diameter: 1710mm (5' 6")
- Height: 1900mm (6' 2")

V3500 Litres (770 gallons)
OTD1058



- Diameter: 2150mm (7')
- Height: 1885mm (6' 1")

V9400 Litres (2070 gallons)
OTD1064



- Length: 3150mm (10' 3")
- Width: 2490mm (8' 16")
- Height: 2960mm (9' 7")

H1550CDD Bunded Diesel Dispensing Tank (345 gallons)
OTD1044



- Length: 2000mm
- Width: 950mm
- Height: 1500mm

H2500CDD Bunded Diesel Dispensing Tank (294 gallons)
OTD1057



- Length: 2300mm
- Width: 1250mm
- Height: 1450mm

V5000PDDFM Deso Fuel Dispenser - 5000L (1000 gallons)



- Diameter: 2480mm (8' 1")
- Height: 2000mm (6' 5")

Each DESO dispenser pump comes with:

A 240v pump, a 4m delivery hose (3/4") with an automatic shut off nozzle, a 10 micron particulate filter, an overflow prevention valve clock type contents gauge.

TruckMaster



- Secure and reliable
- Safe transportation of diesel fuel
- Available with or without digital flow metre.
- Manufacturer 5 year guarantee.

Capacity	Dimensions
200L	600mm (L) x 800mm (W) x 620mm (H)
300L	600mm (L) x 800mm (W) x 890mm (H)
430L	1180mm (L) x 800mm (W) x 910mm (H)
900L	1410mm (L) x 1050mm (W) x 1210mm (H)

Truckmaster is available on customer request

Which size water tank do you need?

Calculating the size of a rainwater harvesting tank involves considering several factors, such as the average rainfall in your area, the surface area available for collecting rainwater, the intended use of the harvested water, and any specific requirements you may have. Here's a general approach to help you calculate the tank size:

- 1. Determine your water needs:** Start by assessing how much water you need to store. Consider your household or specific usage requirements, such as gardening, irrigation, or toilet flushing. Calculate the average daily water consumption or the amount of water you want to collect during a specific period.
 - 2. Determine the collection area:** Next, determine the surface area available for collecting rainwater. This could be the roof area of your house, a garage, or any other structure that can efficiently capture rainfall. Measure the length and width of the collection area and multiply them to get the total collection area in square meters.
 - 3. Determine the rainfall factor:** Research the average rainfall in your area. You can obtain this information from local weather records or online databases such as the Met Office. The rainfall is usually measured in millimeters. Convert the rainfall value to the same unit as your collection area (e.g., millimeters to square meters).
 - 4. Calculate the volume of water:** Multiply the collection area by the rainfall factor to determine the volume of water that can be collected during a rain event. This will give you the amount of water in cubic meters.
 - 5. Consider efficiency and storage capacity:** Rainwater harvesting systems are not 100% efficient due to factors like evaporation, leaks, and system losses. To account for these inefficiencies, multiply the calculated volume of water by a factor between 0.5 and 0.9. This will give you an estimate of the effective volume of water you can expect to collect and store.
 - 6. Calculate the amount of persons or animals usage**
 - 7. Select the tank size:** Based on the effective volume of water calculated in the previous step, choose a tank size that can accommodate that amount. Rainwater tanks are available in various sizes and shapes. Consider factors like available space, budget, and any local regulations or restrictions on tank sizes.
- It's important to note that this is a general approach to help you estimate the tank size. You may need to adjust the calculations based on specific factors in your situation. Additionally, it's recommended to consult with local experts or rainwater harvesting professionals who can provide more accurate guidance based on your location and specific needs.

Potable & Non-Potable Storage Tanks

The UK's No.1 water storage tanks for drinking water and rainwater harvesting systems.



280 to 10 000 litre storage tank options available

Click link to view water storage tank range



Sewage Treatment Tanks

Sewage Treatment Plant

OT6025 4 PERSONS
OT6030 6 PERSONS



- Tested to BSEN12566:3
- CE-marked to ensure compliance with latest environmental and Building Regulations requirements
- Three chamber system correctly sized for separation and retention of solids improves final effluent quality

4 Person

- 1600mm (L) x 1332mm (W) x 1575 (H)

6 person

- 2602mm (L) x 1650mm (W) x 1935 (H)

Capacity	Code
4 person	OT6025
6 person	OT6030

Larger sizes available

Septic Tank

- Tested to BSEN12566 1
- CE-marked to ensure compliance with latest environmental and Building Regulations requirements

OT6010

- 2800L (600 gallons)
- Diameter - 1870mm
- Height - 2780mm

OT6020

- 3800L (835.88 gallons)
- Diameter - 2075mm
- Height - 3000mm

OT6023

- 4500L (989.88 gallons)
- Diameter - 2196mm
- Height - 3100mm



Capacity	Code
2800L	OT6010
3800L	OT6020
4500L	OT6023



Sewage treatment systems, what are your options?

Choosing the right sewage treatment and disposal method for your site is essential to ensure effective long-term performance, protection of public health and the environment, and compliance with relevant legislation. Sewage treatment and disposal can be provided by either public (foul) sewer or by a private sewage system. Use of a private system is only usually acceptable where connection to the public sewer is not possible, and as such should be discussed with your local Planning Authority at an early stage. Before sewage effluent can be discharged to 'controlled waters' it must receive at least primary and secondary treatment:

- For a discharge to ground the micro-organisms in the soil provide the secondary treatment
- For a discharge to a water course the sewage treatment must be provided by a Package Sewage Treatment Plant (PSTP) or equivalent



Marsh Ensign is widely regarded as one of the most efficient, reliable and economical sewage treatment plants on the market

Site visits available on request

Click link to view full product range and installation details



System selection

Hierarchy of off-mains discharge routes as laid out by the environmental regulators and British Water

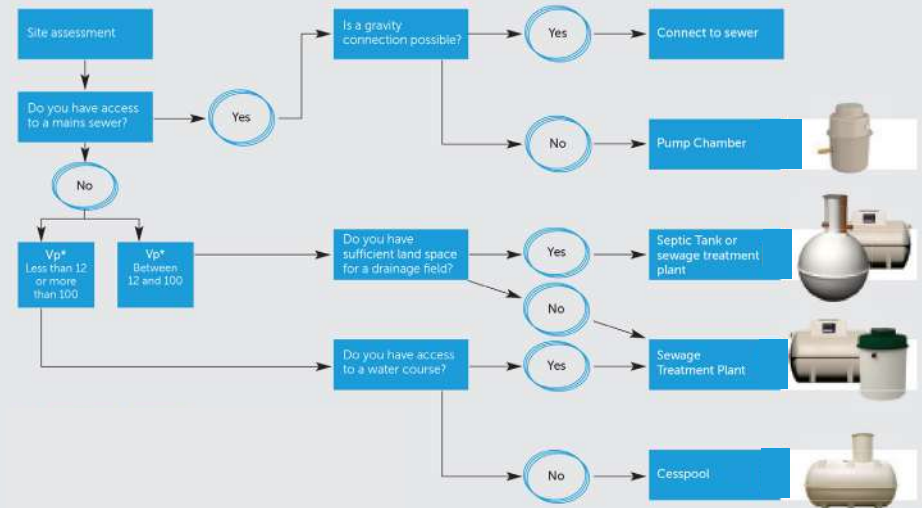

Water & Drainage

Quick
Chapter
Links



Water solutions for the farm and field



Ball Valve and Stop Taps

When water temperature drops below 0°C and turns to ice it can increase pressure and break traditional valves. The arctic resistant valve has been designed to absorb the increased water pressure during colder temperatures.



Universal Fittings

Ideal for emergency repairs, Plass4 connects metric polyethylene to other pipe materials. Plass4 is easy to use with no specialist tools needed to complete the joint.

Water Pipe Fittings

WRAS approved water pipe fittings. We stock a wide range of water pipe fittings. From ballvalves to stop tap chambers, Tees, elbows and couplers to non return valves and more, we can solve your burst pipe in a hurry.



Twinwall Pipes

A new generation of HDPE, this 6m long high performance twinwall pipe is designed for use with all non-pressure, surface and sub-surface storm water drainage applications.



Flexible Land Drainage Pipes

Plastic land drainage pipe is a modern replacement for clay pipes and has been universally and effectively used for over thirty years. This product is available in perforated and non-perforated options and in a range of sizes.

Drainage is of paramount importance to alleviate water-logged fields, lawns and gardens. Our products are suitable for domestic and commercial use so you can ensure that your land is protected from unexpected water leaks.



MDPE Pipes

MDPE 20mm pipe has replaced the old black 1/2" class C & D pipe. 25mm has replaced the old black 3/4" class C & D pipe and 32mm has replaced the old black 1" class C & D pipe. All sizes are available in 25m, 50m, 100m, and 150m coils. Universally accepted as an established alternative to ductile iron and UPVC pipes.



To view the complete McVeigh Parker water & drainage product range simply click the link to the right. ▶

Or use the following URL:
www.mcveighparker.com/water-and-drainage



Plasson Emergency Repair Kits

Let's face it, burst pipes happen... often needing a quick and affordable solution to get things fixed, preserving your precious water supply.

Plasson offer a range of clever products to solve your water leak problems.



Did You Know?



We also stock all the fittings required for water trough installations, stoptap chambers, concrete trough supports, non return valves, stop taps, ballvalves, pipe and fittings.

Be WRAS & Water Board Compliant

BLACK 2 BLUE™ BLACK 2 BLACK™

A Must Have For Every Tool Kit

BLACK 2 BLUE - Imperial pipe connecting to metric PE: 1 fitting, no insert on imperial pipe, liner only required for metric pipe.

BLACK 2 BLACK - Imperial pipe, Class C & D, low and high density: 1 fitting, no insert, no liners.



Click the link water trough install guide

KEY FEATURES

- Assembly tools not required.
- No inserts needed.
- Seal is made when pipe inserted.
- Doesn't restrict flow or risk blockage.
- No need to disassemble.
- Easy to re-use.
- 50 year design life.



Click link above to view full product range



MDPE Water Pipe

Commonly known as alkathene pipe, 20mm has replaced the old black 1/2" class C & D pipe, 25mm has replaced the old black 3/4" class C & D pipe and 32mm has replaced the old black 1" class C & D pipe. All sizes are available in 25m, 50m, 100m, and 150m coils.



Universally accepted as an established alternative to ductile iron and UPVC pipes.

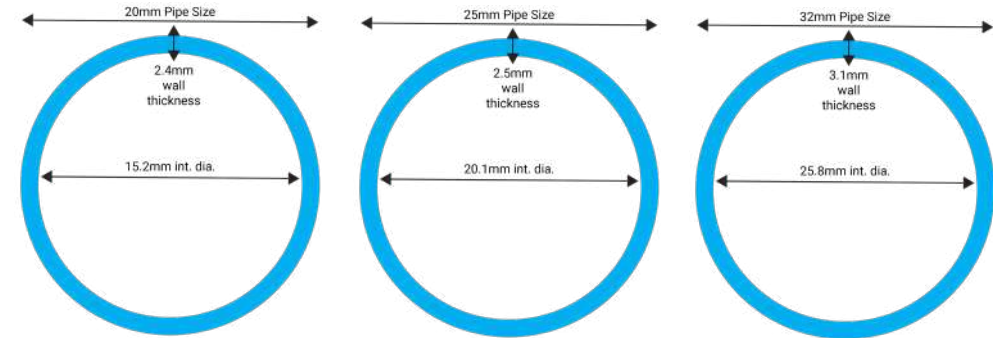

- Pipe Size - 20mm
- Average bore I.D. dia - 15.2mm
- Average wall thickness - 2.4mm
- Average weight per Mtr - 0.13kg

- Pipe Size - 25mm
- Average bore I.D. dia - 20.1mm
- Average wall thickness - 2.5mm
- Average weight per Mtr - 0.16kg

- Pipe Size - 32mm
- Average bore I.D. dia - 25.8mm
- Average wall thickness - 3.1mm
- Average weight per Mtr - 0.27kg

20mm	
Coil Length	Code
25m	PPBU20025
50m	PPBU20050
100m	PPBU20100
150m	PPBU20150

25mm	
Coil Length	Code
25m	PPBU25025
50m	PPBU25050
100m	PPBU25100
150m	PPBU25150

32mm	
Coil Length	Code
25m	PPBU32025
50m	PPBU32050
100m	PPBU32100
150m	PPBU32150

Stocked in blue - Black also available

Plastic Land Drainage (Flexi-Pipe)



Plastic land drainage pipe is a modern replacement for clay pipes and has been universally and effectively used for over thirty years.

Perforated and non-perforated options are available, in a range of pipe diameters, 60-160mm.

Perforated land drainage

- Principally used to alleviate water logged fields, lawns and gardens.
- The plastic drain is laid in a permeable stone enclosure allowing the water to filter through to the plastic pipe which then directs the water to the designated outlet.



Non-perforated land drainage

- Commonly used under gateways or when filling in a ditch.



** Please note – Various sizes available, dependent on the severity of the problem. Membrane sleeves can be added to the pipe particularly for fine soil types to prevent pipe blockage.*



Benefits

- Strong and flexible
- Fast installation
- Provides excellent water flow
- Kitemarked to BS 4962:1989, License No. KM557607
- Manufactured from high quality RHDPE
- Tightly wound coils that enables easy stacking and handling

Twinwall Pipe Lengths



A new generation of HDPE, this 6m long high performance twinwall pipe is designed for use with all non-pressure, surface and sub-surface storm water drainage applications.

Twinwall pipe is made by a twin extrusion process, which forms two pipes and heat welds them together as they are formed. It features a smooth bore for superior hydraulic flow and corrugated outer wall for additional strength.

Perforated and non-perforated options, in a range of pipe diameters from 94mm/110mm - 589mm/676mm (ID/OD). Half perforated available on special request.

Why Twinwall?

- 50+ year life span
- High strength and durability
- Manufactured and tested to BBA
- Can easily be cut to required lengths on site
- Lightweight – easier transport, handling and installation
- Saves machinery and labour costs as installation is quicker
- Weighs less than 6% of equivalent size concrete pipes
- Minimal jointing compared with traditional materials
- Provides a faster flow meaning it is more likely to keep itself cleaner than singlewall pipe



Twinwall half perforated available by special order

Inside Diameter (ID)	Outside Diameter (OD)	Length (m)	Finish	Code
94mm	110mm	6m	Perforated	LDPTW22
			Non-perforated	LDPTW20
150mm	180mm	6m	Perforated	LDPTW00
			Non-perforated	LDPTW01
225mm	266mm	6m	Perforated	LDPTW10
			Non-perforated	LDPTW15
300mm	354mm	6m	Perforated	LDPTW02
			Non-perforated	LDPTW1
450mm	511mm	6m	Perforated	LDPTW30
			Non-perforated	LDPTW35
600mm	676mm	6m	Non-perforated	LDPTW40

AGRI

- Perfect for many agricultural, construction and civil engineering projects

SPORTS

- Ideal for golf course & sports field drainage
- Can also be used in the construction of under pitch heating

CIVILS

- Can be used in landfill applications for leachate drainage and methane gas control

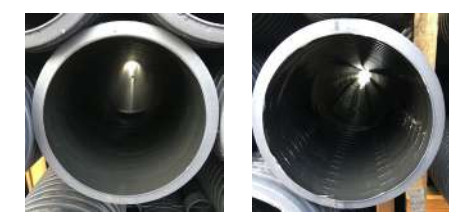

AGRI

RIDING ARENAS

SPORTS

CIVILS

Twinwall Pipe - Standard Diameter

ID OD	PACK QTY	PERF TYPE
∅ 589 676mm	2	⊗ ⊗ ⊗
∅ 450 511mm	4	⊗ ⊗ ⊗
∅ 300 354mm	8	⊗ ⊗ ⊗
∅ 225 266mm	14	⊗ ⊗ ⊗
∅ 150 180mm	36	⊗ ⊗ ⊗
∅ 94 110mm	100	⊗ ⊗ ⊗

PACKS SOLD IN INDIVIDUAL LENGTHS

Stock item

Twinwall Pipe - Large Diameter
SUPPLIED TO SPECIAL ORDER

ID OD
∅ 1200 1290mm
∅ 1050 1140mm
∅ 900 972mm
∅ 750 822mm

• WRC Certified
Special order item

FILTER DRAIN | PERFORATED (P)

HALF FILTER DRAIN | HALF PERFORATED (H)

CARRIER DRAIN | NON-PERFORATED (N)

Twinwall Ducting

Flexible Drainage Pipe

ID OD	LENGTH (M)
∅ 135mm 160mm	50
∅ 85mm 100mm	25 50 100
∅ 65mm 80mm	25 50 100
∅ 50mm 60mm	50 100

Inside Diameter (ID)	Outside Diameter (OD)	Length (m)	Finish	Code	
135mm	160mm	50m	Perforated	LDP164	
			Non-perforated	LDP160	
85mm	100mm	25m	Perforated	LDP101	
			50m	Non-perforated	LDP106
				100m	Perforated
65mm	80mm	25m	Non-perforated	LDP105	
			50m	Perforated	LDP081
				100m	Perforated
50mm	60mm	50m	Perforated	LDP080	
			150m	Non-perforated	LDP085
				Perforated	LDP062
			Perforated	LDP060	
			Non-perforated	LDP061	

Twinwall Fittings and Accessories

Don't forget to add Couplers / Seals!

Coupler	Tee Junction	Y Junction	Bends	Reducers
Sizes (mm)	Angle Sizes	Angle Sizes	Angle Sizes	Sizes
100 150 225 300 450 600	90° 110-1200	45° 110-1200	15, 30, 45, 90° 110-1200	110-1200

Seals	End Caps	Lateral Connectors	Twinwall - Adapters	Twinwall - Land Drainage Fitting
Sizes (mm)	Sizes (mm)	Sizes (mm)	Various Sizes available	Various Sizes available
100 150 225 300 450 600	110-1200	110-150		

IDEAL FOR CARRIER DRAINS

Flexible Black Ducting c/w Draw String

ID OD	LENGTH (M)
∅ 146mm 160mm	50
∅ 94mm 110mm	50
∅ 50mm 63mm	50

Inside Diameter (ID)	Outside Diameter (OD)	Length (m)	Finish	Code
146mm	160mm	50m	Non-perforated	LDP075
94mm	110mm	50m	Non-perforated	LDP070
50mm	63mm	50m	Non-perforated	LDP065



Ducting Fittings and Accessories

Multi Branch	Maxi Branch	Connectors	Reducers
Sizes (mm)	Sizes (mm)	Sizes (mm)	Sizes (mm)
60 - 100	100 - 160	60 80 100 160	100 - 60

Visit our Website!

Still haven't found what you're looking for?

Then no worries, either click one of our links throughout this brochure or go to mcveighparker.com and check out our whole product range. Our experienced and helpful sales staff look forward to dealing with your request very soon.



NEED MORE INFO?
Use our spec sheets to find out more



Landscape & Roofing

Make your outside space that little bit more special



Garden Design

Add the finishing touch to your project with one of our garden planters or traditional picnic benches. Our planters are made from galvanised steel (beware inferior alternatives) and our picnic benches provide a rustic option for alfresco dining.



Path Edging & Membrane Pins

Designed by landscape architects the award winning system is the perfect way to achieve straight, cornered and enviable curves and shapes in your landscaping project.



Roofing

Once you have completed your work, you want to ensure that it is fully protected from the elements. Our range of roofing solutions includes the popular Onduline Roofing, an extremely tough yet lightweight material with unrivalled versatility as a roofing or wall-cladding option.

Sleepers

Available in green oak and hardwood our quality sleepers are suitable for an array of projects from soil retention to raised beds.



Netting

For a quick, economic and effective solution, netting is useful in deterring access to your land from unwanted visitors (both human and animal!) Shop our range of plastic netting now.

Our landscaping options includes a selection of ground protection, sleepers, roofing and products to enhance your garden. We also have temporary netting solutions available to keep your project secure whilst it is under construction.



Ground Protection

Our range of ground protection includes woven and non woven geotextile membrane. It is available in a range of sizes and grass protection solutions, all of which are suited to areas that receive heavy traffic including pedestrian and agricultural footfall.



To view the complete McVeigh Parker landscaping product range simply click the link to the right. ▶

Or use the following URL:
www.mcveighparker.com/landscaping



Sleepers

Hardwood Sleeper

F6090



- Grade A traditional reclaimed railway sleepers
- 2590mm x 250mm x 150mm

Green Oak Sleeper

F6085



- New green oak sleepers
- 2400mm x 200mm x 100mm

Geotextile Membrane

Non-Woven Geotextile Membrane



Length	Code
4.5m x 100m (standard)	LDP720
4.5m x 100m (Premium)	LDP726

- Ideal for the separation of granular layers and ground reinforcement
- CBR puncture resistance (N)
- Water permeability (m/sec)

Woven Geotextile Membrane



Length	Code
4.5m x 10m	LDP710
4.5m x 100m	LDP700

- Ideal for weed suppression and ground stabilisation
- Higher strength and lower permeability
- Two different roll sizes

Plywood Sheets



- Perfect for a huge range of roofing & building uses
- 2440mm x 1220mm Plywood sheets
- Available in 12mm and 18mm thickness
- Hardwood face

Length	Code
Plywood 2440 x 1220 x 12mm	F6050
Plywood 2440 x 1220 x 18mm	F6055

Ground Protection

Grass Protection Mesh

F6085

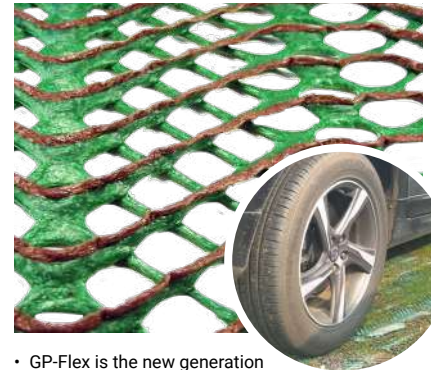

- GP-Flex is the new generation grass protection mesh
- Features a slip resistant surface and more flexible profile
- Available in 3 different grades
- Roll size - 2m x 20m
- Slip resistant surface

Weight	Size	Code
1000g	2m x 20m	NET293
1400g		NET294
1800g		NET292

Permeable Plastic Pavers

NET295



- Suitable for very heavy duty applications
- Used for overspill car parks, driveways and shed bases
- Each paver 330 x 330 x 40mm, 9 pavers per m2
- Interlocking plastic grid paving system
- 330 x 330 x 40mm
- Load bearing: 250 - 350 tonnes/m2 on a correctly specified and compacted sub-base

For full details check out the Pavers spec sheet, click the link below



Barrier Safety Netting

NET001



NET002

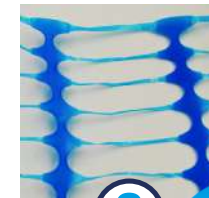

- Size: 1m x 50m
- High visibility mesh
- Erect using steel fencing pins available separately
- Available in orange and blue



Did You Know?

We also sell J & U pin path edging, see page 131



Barrier Netting Support Pins available on request

Chesnut Paling

Our Paling Fencing, a classic and versatile fencing solution designed to cater to all your fencing needs. Manufactured from coppiced woodland, this fencing product showcases the perfect combination of durability, flexibility, and ease of installation.

The wood is skillfully split into pales, and galvanized wire is intricately woven between them, ensuring exceptional strength and longevity.



Size	Code	Size	Code
900mm Paling Fence 3 Line - 9.1m Roll	F4201	1400mm Paling Fence 3 Line - 9.1m Roll	F4206
900mm Paling Fence 2 Line - 9.1m Roll	F4200	1500mm Paling Fence 3 Line - 4.55m Roll	F4207
1200mm Paling Fence 3 Line - 9.1m Roll	F4205	1800mm Paling Fence 3 Line - 4.55m Roll	F4207
1200mm Paling Fence 2 Line - 9.1m Roll	F4204		



Coppiced & Made In England

NEED MORE INFORMATION?

Use our spec sheets to find out more



McVeigh Parker
Farming and Fencing Specialists

Case Studies

Showcasing a wide range of completed fencing projects throughout the United Kingdom



Features

- Triple X fencing
- X™ fence®
- Bespoke Post Design
- Countryside Stewardship



Plus many more



Click the link to view and download our case studies brochure

Click the link to view our full spec sheet list



Specification sheet categories to choose from:

Fencing, Farming, Tools & Fixings, Gates & Landscaping

Trough Planters



Standard Trough Planter

- Manufactured from 1.6mm flat steel

Size	Code
900x457x267mm	STPWT409
1200x457x267mm	STPWT412
1800x457x267mm	STPWT418
2400x457x405mm	STPWT424

Large Trough Planter

- Manufactured from 1.6mm flat steel

Size	Code
600x457x267mm	LTP06
900x457x267mm	LTP09
1200x457x267mm	LTP12
1800x457x267mm	LTP18
2400x457x405mm	LTP24
3000x457x405mm	LTP30

Extra Large Trough Planter

- Manufactured from 2.0mm flat steel

Size	Code
1200x457x405mm	XLTPWT212
1800x457x405mm	XLTPWT218
2400x457x405mm	XLTPWT24
3000x457x405mm	XLTPWT230



Concrete supports are extra, see P97

Bench & Tables

Corfe Traditional Picnic Table

F6505



- Table top 1.75m (L) x 740mm (W) x 40mm thick.
- Main frame 90mm x 40mm.
- Assembled size 1.75m (L) x 1.5m (W) x 810mm (H)

Warwick Circular Picnic Table

F6500



- Main frame 90mm x 40mm
- Height assembled 810mm

Did You Know?



Whatever project you are undertaking, industrial, agricultural or domestic, we have the tools and fixings you need to ensure you get the job done.

Check out our tools and fittings section from page 126 to 145.

Roofing

Onduline Roofing

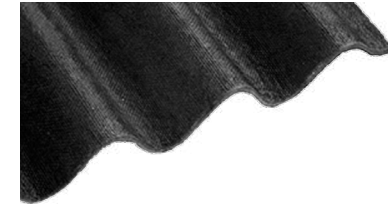

- Sheet size : 2000mm x 950mm x 3.0mm thick
- Cover width: 855mm
- Corrugation: 38mm high x 95mm width
- Weight: 6.4kg

Colour	Size	Nail Code
Black	2000mm (L) x 950mm (W) x 3.0mm thick	RS300
Green		RS305
Red		RS307
Brown		RS309

Onduline Nails

RS325 (Black)



- Nail length including cap: 73mm
- Nail penetration length: 65mm.

**Bags of
(400) per
20 sheets**

Corrugated Galv Sheeting



Description	Code
1800mmx14/3x24kg galv corrugated sheet	RS106
2100mmx14/3x24kg galv corrugated sheet	RS107
2400mmx14/3x24kg galv corrugated sheet	RS108
3000mmx14/3x24kg galv corrugated sheet	RS110
3300mmx14/3x24kg galv corrugated sheet	RS111
3600mmx14/3x24kg galv corrugated sheet	RS112
4200mmx14/3x24kg galv corrugated sheet	RS114



Onduline Ridge

RS310



- Cover width: 775mm
- Weight: 1.2kg

Colour	Size	Code
Black	2000mm (L) x 485mm (W) x 2.9mm thick	RS310
Green		RS315
Red		RS317

Onduline Translucent PVC Sheet

RS318

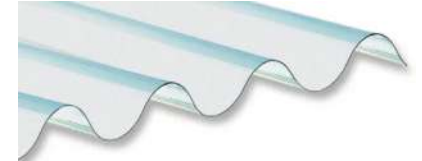

- Sheet size: 2000mm x 950mm x 3.0mm thick
- Cover width: 855mm
- Corrugation: 38mm x 95mm
- Weight per sheet: 6.4kg

Box Tin Roofing

Available on request



Click the link to view full product range

Tools & Fixings

For industrial,
agricultural &
domestic use

Digging



Our range includes all your essentials, including post hole diggers, chisels and points as well as a selection of shovels. We also stock a wide range of insulated tools which conform to BS8020:2011 and are flash tested to 10,000 volts to ensure safe working practice.



Fixings

We have a comprehensive range of netting clips and other fixings for fence erection and much more. Our stapling range helps you to make a quick job of stock fencing.

The range includes battery powered staplers.



Other Tools

Aptly named 'other tools' this category contains our range of wheelbarrows, tarpaulins, spinning jenny wire dispensers and more.

Tensioning

Suited for horse or deer stock fencing and netting. Our range of tensioning tools has all you need. Products include a selection of innovative Gripple tensioning products, boundary clamps, wire chain strainers, wire pullers and more.



Striking

Sometimes you need to pack some power to get the job done. Our striking tools are perfect for making an impact when you need to get deep. We have sledgehammers, shock hammers, petrol driven post drivers and log splitting tools.

Whatever project you are undertaking, industrial, agricultural or domestic, we have the tools and fixings you need to ensure you get the job done from many great tool brands



Cutting & Joining

Our innovative cutting and joining products help make easy work of wire cutting and joining your fenceline with popular products including our Knipex wire cutters, Strainrite Crimps Sleeves and Gripple wire joiners.



To view the complete McVeigh Parker tools & fixings product range simply click the link to the right. ▶

Or use the following URL:
www.mcveighparker.com/tools-and-fixings



GRIPPLE®

Agriculture, Fencing & Equipment

Market-leading wire joiners and tensioners which simplify installation, maintenance and repair across a range of applications.

The Gripple Barbed High Tensile joiner has been intentionally designed to grip the unique shape of barbed wire.



Stronger than a traditional knot

Up to 16% stronger than a traditional wire knot.

Designed for high tensile wire

New patented technology specifically designed for use with high tensile barbed wire.

Easy to install

Join or repair high tensile barbed wire in seconds with audible engagement for added confidence.

Long lasting

Made from corrosion resistant materials, designed to outlast your fence.

Compatible with

Use with 1.57 mm to 2 mm wire (2 x 15.5 swg - 2x 14 swg).

It is fast to install, simple to use, and thanks to the new corrosion resistant ceramic wedge, you can walk away with the confidence that your wire joint will last as long as your fence.

Compatible with all wire sizes from 1.57 mm – 2.00 mm (2 x 15.5 swg - 2 x 14 swg), the new Barbed High Tensile joiner is ideal for installation or fencing repair.

GRIPPLE Fence Kit

As market leader in the joining and tensioning of wire, Gripple is renowned for providing innovative, cost-effective solutions for wire fencing applications. Our products work with a wide variety of mild and tensile fencing wires - across barbed and plain fencing types, and on anything from stock to electric fencing, replacing traditional methods and generating time and labour savings.

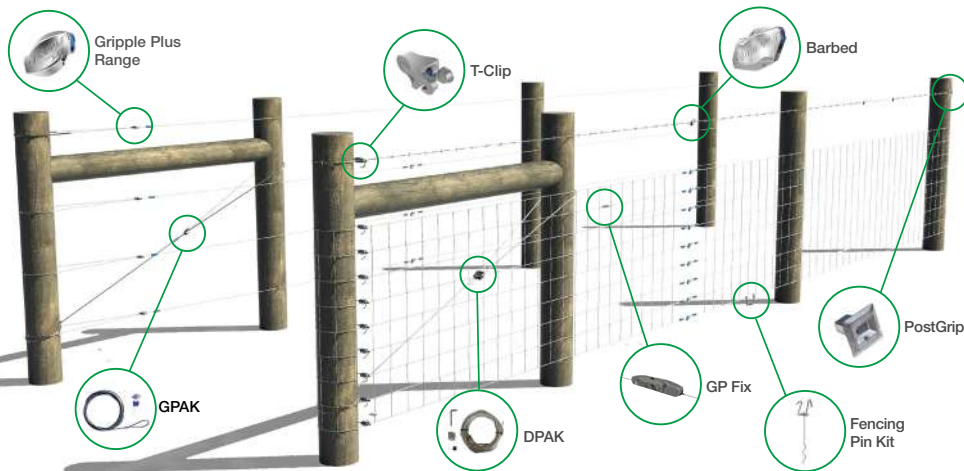

GRIPPLE Orchard Kit

Our range of orchard trellising products have been specifically developed to help with heavy fruit loads. Gripple's range is suitable for orchards in a variety of terrains and soil types.

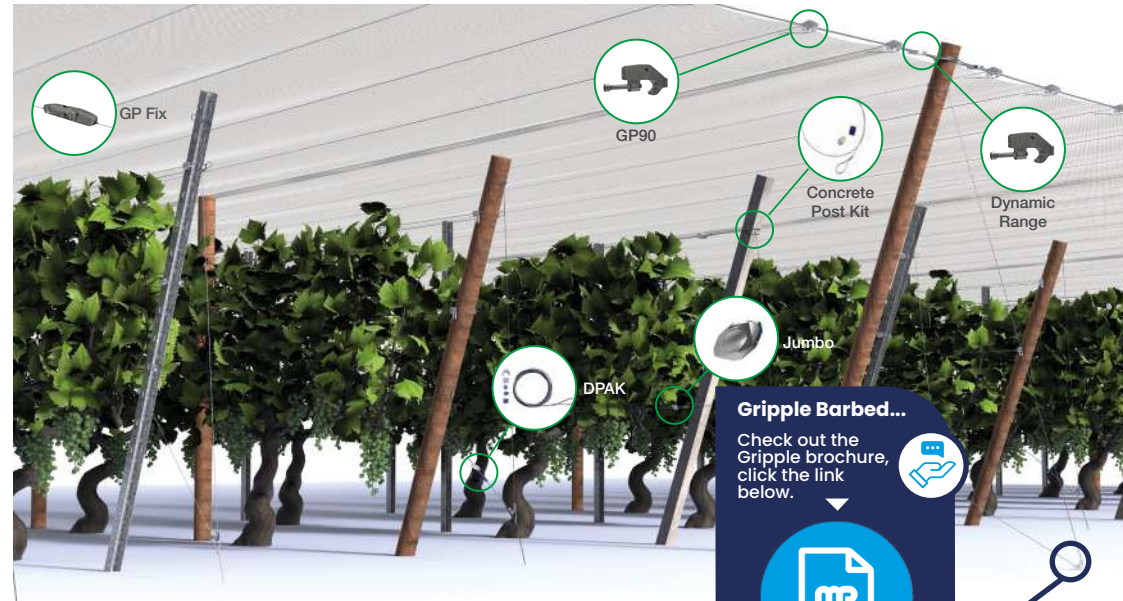

Gripple Barbed...

Check out the Gripple brochure, click the link below.



GRIPPLE Vineyard Kit

In today's vineyards, the wires, posts, and machinery used are constantly being improved, and Gripple prides itself on being part of that evolution. The Gripple Plus product range, along with the Torq Tensioning Tool and Contractor Tool, not only provides a trellising system that can be tensioned in seconds, but one that will last for decades.

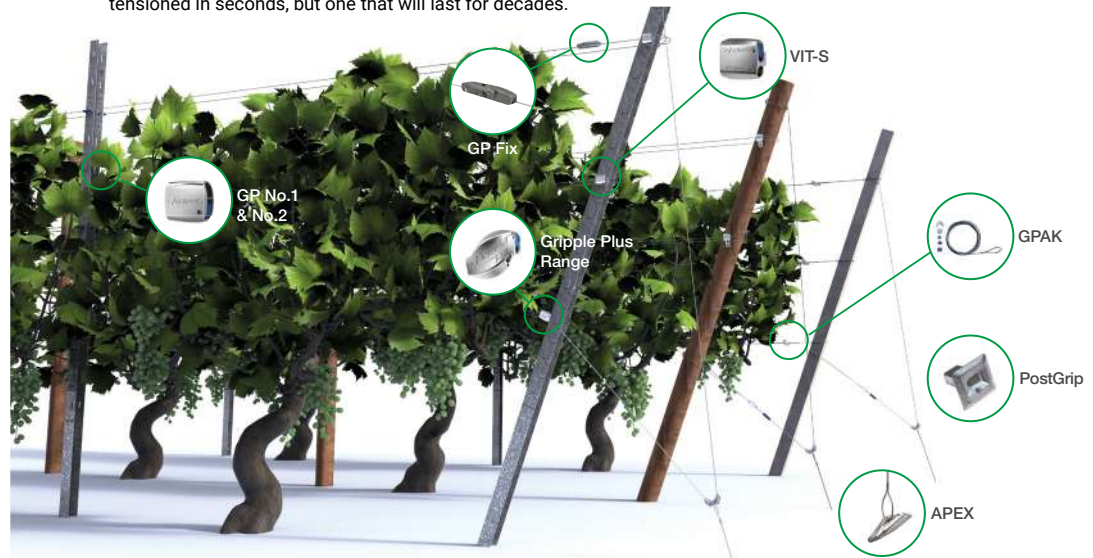

Tensioning



Grippler Contractor Tool
A1518



- 10:1 mechanical advantage, meaning you can apply the same tension with a lot less effort.
- All steel handles

Grippler Tensioning Tool
A1510



- Allows tensioning of wire up to 400 kg
- Minimal effort due to the 6:1 gear drive mechanism

Grippler Wire Joiners

Size	Description	Code
Small 50 per bag	Used to join plain wire and install lightweight stock netting.	A1512
Medium 20 per bag	Used as an in-line joiner or as an end anchor for stock fencing, high tensile barbed wire and plain wire.	A1520
Jumbo 10 per bag	Used as an in-line joiner or as an end anchor for stock fencing, fruit trellising and plain wire.	A1540
Barbed 10 per bag	Specifically designed to grip the unique undulating shape of barbed wire.	A1530 A1531

Grippler T-Clips

Normal 20 per bag
A1525



Barbed 10 per bag
A1525



Grippler Twister Pack
A1550



- Use on 2.00 - 3.25mm wire
- 35mm long
- UV treated for longevity

Grippler GPAK 3 Anchor
A1565



- Includes one medium Grippler
- 3mm wire rope x 4.5m long, 400kg load

Grippler GPAK 4 Anchor
A1570



- Includes one large Grippler
- 4mm wire rope x 5.0m long, 600kg load

Grippler Anchor 3
A1560



- Anchor 3 - Wire rope 3.0mm
- Wire length 1.5m
- Time and labour saving - quick to install
- Minimal ground disturbance
- Suitable for a variety of soil types
- Instant load holding

Grippler Anchor Installation guide

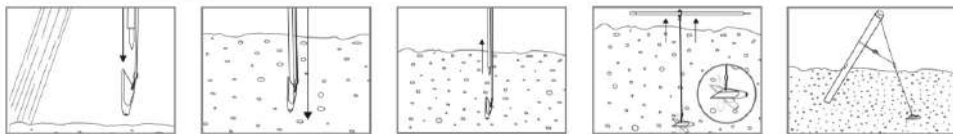

QUIK-END CLIP

CODE: EF4099

Is an easy termination solution. Doing away with end knots and improve the strength of your fence at the same time. Faster than tying off a knot and great value, these clips will save time and money while increasing the strength of your fence.

FEATURES

- Reduce installation time
- Quick, fast and easy to install
- Ideal for fabricated netting, especially Otter and horse netting
- Provides uniform straining position, every time
- Pre-formed loop & knot
- Ability to thread onto wire = fewer joints
- Cost-effective & convenient to use
- No knots are required whatsoever
- Maximum working pressure load 340kg
- 2.50mm spring steel and heavy galvanised finish
- 100 Per Pack



CLICK LINK FOR VIDEO INSTALL GUIDE

Premium Heavy Duty U & J - Pins

Steel U & J - Pins, are tough enough to be driven into most soil types using a simple club hammer. Recommended to hold down fence sections where there is to be a likelihood of dogs or burrowing animals.

The ribbed re-bar fabrication makes them a stronger holding pin than other material types.

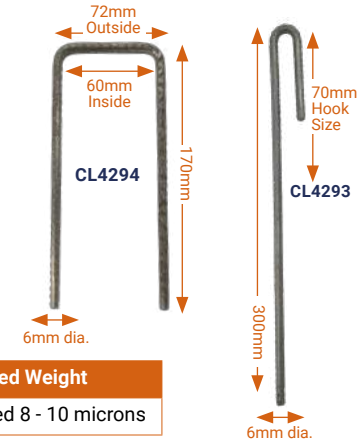

Ideal for grass protection & rabbit netting

Tensile Strength	Weight	Box Contents	Coated Weight
550 - 625N/mm ²	115 grams	200 pins	Electroplated 8 - 10 microns

Estimated Pin Requirements : A guide only, some soil types or topography may require more or less

Initial Roll	Pins req.
*Grass Reinforcement Mesh : 2m x 20m	200
Turf Reinforcement Mesh : 2m x 20m	150
Badger fencing wire netting : 1.58m x 50m	150
* Badger embankment netting (as above)	395
* Rabbit netting fencing per 50m	150
Rabbit netting embankment 50m	300

* J Pins can be used with grass reinforcement mesh, badger and rabbit netting



Note - If soil is soft or you require a stronger holding consider U pins (CL4294) or Terra-pins (A1557).



Strainrite are a leading manufacturer & exporter of quality tools and fencing equipment. Offering a variety of tools and equipment in the field by farmers for farmers. McVeigh Parker are proud to be European wholesalers and retailers of this quality range of products.

Official wholesaler of PROCRIMP F3020 Powered Crimping Tool

Can be used with various Strainrite crimp sleeve sizes upto 4mm



Click the link to view full product details.

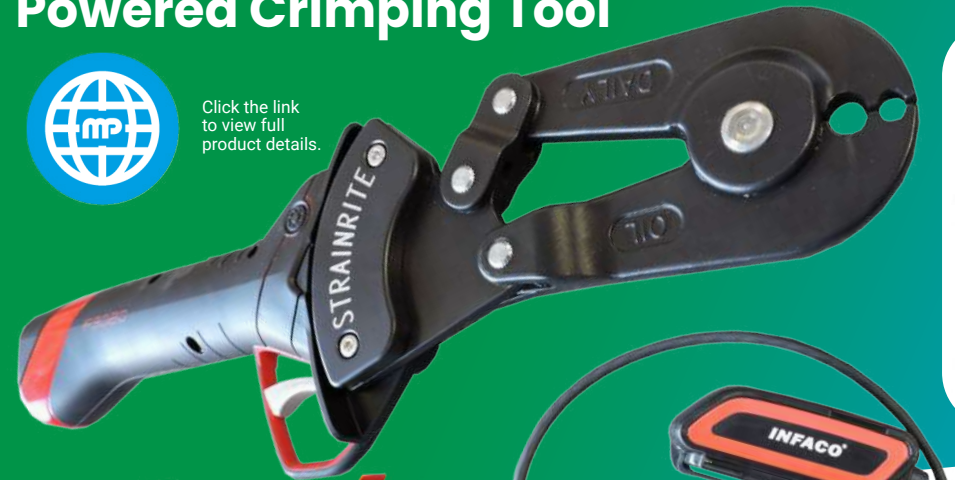

FEATURES

- Light, compact and easy to handle
- Fast jaw action allows repeat crimping
- Battery belt, reduces overall weight of the tool
- Long lasting lightweight battery 8 hours and only 698g
- Crimps all Strainrite crimps up to 4mm without any changes needed, Narrow jaws give you greater access to smaller spaces.

FREE POT OF 2.5mm Crimp Sleeves
When you buy this tool



Striking

Petrol Hand Held Post Driver

CL2795



- Standard 78mm Machine
- KW1.0 (1.3HP) at 7,000 rpm
- 4-stroke, overhead cam
- Trigger throttle with integrated stop button
- Spring isolated hand grips
- Vibration levels m/s² - 9.94 (Data from 100mm diameter wooden post)
- Fuel consumption - 0.71 L/h at 7,000 rpm
- Meets strictest worldwide emission and noise req.
- Weight - 15.3kg
- Engine warranty - 1 Year genuine Honda warranty
- Post driver warranty - 1 Year parts failure
- Noise level - >100dB NOTE: Hearing protection required
- CLIPEX clips & sleeves compatible

Post Drivers

Roughneck Small Post Rammer

CL2790

The Roughneck small post rammer is ideal for driving in angular, tubular and square posts. The heavy gauge tubular steel body accommodates post up to 68mm in diameter, and features large handles for safe and secure use.

- Heavy gauge tubular steel body
- Anti-corrosion powder coated finish



HEAVY DUTY



LARGE HANDLES



POWDER COATED

Internal Dia.	Length	Width	Weight
68mm	714mm	230mm	9200g

Post Hole Bumper/Rammer

A2430

155mm o/d dia painted two handled post bumper/rammer. Essential tool for driving in various sized posts. Manually operated by one or two persons.

- Weight approx. 12.8 kilo.
- Size: 640mm x 155mm dia



Strainrite Steel Post Driver

A2433

- Reduced noise and shock on impact back through operators hands
- Solid welded steel construction
- Special design for improved service life
- Overall height 800mm (31.5")
- Overall width 220mm (8.5")
- Internal Diameter 54mm (2")
- Overall handle Length 520mm (20.5")



Fence Maul with Fibreglass Shaft

A2436

Fencing maul 5kg head with a fibreglass handle, ideal for driving in wooden fence posts.



Fence Maul 5kg Alloy Head c/w Hickory Handle

A2437

- 5kg aluminium alloy hammer head

Clipex Standard Post Rammer

A2428

Handy for Clipex standards and eco posts and timber stakes up to 70mm diameter.

- 70mm diameter
- 8kg weight
- 80cm length



Fence Maul with Hickory Handle

A2435

Fencing maul 5kg head with a hickory handle, ideal for driving in wooden fence posts.



Post Driver Sleeves

Strainrite Steel Post Drive Sleeve 54mm

A2434

- Solid welded steel construction and painted finish
- Use with sledge hammer
- Overall height 180mm (7")
- Internal diameter 54mm (2")
- Suitable for light duty driving of steel posts, tie-down posts & finish driving of earth stakes



Visit our Website!

Still haven't found what you're looking for?

Then no worries, either click one of our web links throughout this brochure or go to mcveighparker.com and check out our whole product range. Our experienced and helpful sales staff look forward to dealing with your request very soon.



Staple Pullers / Cutters

Do you struggle getting staples out of old posts? Not anymore, Strainrite's Staple Puller simplifies the job, no more fighting with hammer, crimp sleeves and fencing pliers!

This is not just a staple puller, this multi-purpose tool has a wire cutter that competes with some of the best in the market. It can also be used to strip, grip and twist wire.



Ezepull Ultracrimp
5 in 1 Fencing Tool
A2247



5 in 1 tool

Crimp Sleeves

Genuine New Zealand made crimp sleeves are used to permanently join wire netting and line wire.

These crimp sleeves provide a joint that exceeds the strength of the wire. It's the easiest and most effective means of joining wire without the time consuming job of hand tying. Crimps are designed to provide a non-abrasive permanent joint, almost half the price of standard wire joiners such as Gripples, using both will give you permanent joints, whilst Gripples will allow you to re-tension the fence should you wish to at a later date.



Strainrite
Crimps
A1341

Wire Strainers

The most versatile wire strainer.

Why use an XT1 instead of standard cliplock? They have the added advantage of a wire capture lug meaning they can be used in the fence line, not just at ends. Ideal for starter runs and can be retensioned.



XT1 lug capture

Strainrite XT1
Permanent Wire
Strainer
EF4097



DURASHIELD Insulator

- Superior electrical retention in wet conditions
- Compatible with Cliplock or XT1 permanent wire strainers
- Engineered for top performance at an affordable price



Strainrite
Durashield
Insulator
EF4097D

- Simple replacement with Snap-On fitting system
- Constructed with Ecoblend ASA – strong, durable and UV-stabilized
- Insulators only, sold in packs of 10

Insul Activator Strap

Insul-activator strap insulator is a unique product, quick and simple to install with various advantages over traditional methods.

Multi-function Post Insulator - Eliminates auxiliary components such as the egg insulator, pin lock insulator, activator plate and separate electrical lead.



Handles
not
Included

Cutting & Joining

Strainrite Staple Cutter/Puller

A2016



- One Handed Staple Pulling PLUS Wire Twister, Wire Cutter, Wire Stripper and Wire Grip
- Ergonomic design that is comfortable to use and well balanced
- Dimensions: 75mm x 265mm

Strainrite Standard Wire Cutter

A2019



- Lever action
- Hardened cutting edges for up to 2.5 HT wire
- Comfortable non-slip handles.
- Overall length 205mm (8")

Multi Fence Pliers

A2000



- Head incorporates a striking face
- Staple removing hook
- Pincer and clamp on top jaw

Expert Wire Cutters - Parrot Beak

A2012



- Essential for cutting stock fencing, barbed and line wire
- Single handled use

Knipex Cutters

A2043



- Precision cutting
- Suitable for soft and hard wire up to 5.2mm
- 64 HRC on the Rockwell rating system
- Recess cutting edge
- Cuts spring steel up to 3.6mm

Knipex Compact Bolt Cutters

A2041



- Extremely high cutting performance in a convenient length of 160 mm
- Small, slim head for excellent accessibility
- Compact and powerful: cuts bolts, nails, rivets etc.

Maun Parallel Action Side Cutter

A2020



- 200mm - Maun pliers
- Cutting capacity Ø (mm)
Hard Wire - 2.5 / Soft Wire - 6.0
- Jaw width (mm) - 12.5
- Jaw opening (mm) - 17



McVeigh Parker are a main supplier of Strainrite Fencing Systems. Contact one of our depots to find out more.

Wireman Tools



"The Gripper"
A2218



- Will not slip or drop off the wire
- 1-4mm wire capacity
- Easy to handle
- Spring loaded
- Plier type release
- Replaceable grip points
- 6mm quick link

Winch Strainer
A2219



- Easy to use
- Non-slip replaceable teeth
- Deliver full load transfer
- Wire strainer, 500kg hoist

Digital Tension Gauge
A2213



- 300 Kgs in Line Crane Scale
- Cast Alloy Body
- Large 2" LCD backlight display
- 2 AA Batteries Supplied
- 10mm Diameter Stainless Steel U bolt and Hook
- Measure Tension in Kilos, Newtons or Pounds.

Helpful Hint

The Wireman Winch, a safer tool and more precision.

Enabling you to grip the wire without maintaining tension on the wire. Spring loaded scissor action jaws make them easy to attach and release.

GRAB A GRIPPER

INNOVATIVE TOOLS MAKING FENCING EASIER, FASTER AND SAFER

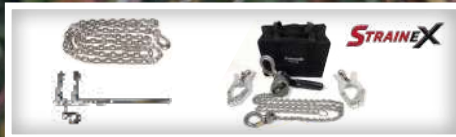

Years of reliability and trouble-free straining

Milwaukee Fencing Tools



Milwaukee M18 Fuel Utility Fencing Stapler



Stapler

- Milwaukee M18 Fuel Utility Fencing Stapler x 1
- M18 High Output 3.0AH Battery x 2
- M12-18 Fast Charger x 1
- Kitbox x 1

One full charge will approximately use one box of staples

Milwaukee M18 Fuel Utility Fencing Staples

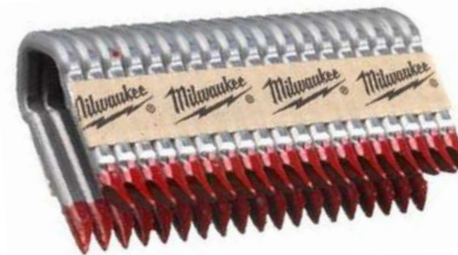

Suitable for all types of wire fencing attached to wood ie. livestock fencing, square/chain/barbed wire and high tensile wire. Staples are hot dipped galvanised coating for superior long term corrosion resistance and made from 4mm thick steel wire for best lifetime in outdoor applications.

Features sharp divergent point tips – the staple point tip twists as it is driven into the wood giving better holding power and the red adhesive coating gives increased drivability while maximizing holding power.

Staple Box Options	Code
40 x 4mm staples	FX2745
45 x 4mm staples	FX2746
50 x 4mm staples	FX2747

Click link to view full product range



Did You Know?

We also stock standard & barbed fencing staples

See page 143

Tensioning & Strainer Tools

Simple Wire Tensioner

A2245



- A simple wire strainer
- Pivoting head pinching the single wire gives excellent leverage
- Compatible with plain or barbed wire 1.6 - 4.0mm

Fence Wire Tensioner

A2246



- Fence wire tensioning tool designed for tensioning wire (including barbed wire) up to 4 mm diameter prior to stapling onto wooden fencing posts
- Stock fence netting can be tensioned one strand at a time, ideal for emergency repairs

Strainrite Tensioning Tool

A2243



- Easily tie off/staple wire hands free!
- Quick and easily tensions either fence or netting wire around strainer posts
- Smooth grip wire clamp prevents wire damage
- Overall length approx 678mm (26")

Hook Chain Strainer

A2210



- Chain length: 6 Metre (19'7") tested chain
- Clevis hook on the chain and strainer body
- Loading: 600kg load max
- Handle length: 45cm (18")
- Simple to use

Wire Grab Strainer

A2215



- Also known as a Monkey chain strainer
- Swivels for left or right hand operation
- Compatible with single or barbed wires, from wire dia - 1.6mm to 5.0mm

Boundary Clamps

Strainer clamps are a specialist item used by professional fencing contractors. It is the perfect tool to provide correct and even tension to any livestock fence. It will save you time and money in erection costs whilst ensuring that you achieve a professional constant tension.

Options Available

McVeigh Parker strainer clamps are available for stock fence, horse and deer netting. Dependent on your choice of clamp for stock fence, horse or deer netting, the clamp has 3-5 tensioning points both sides. Simply attach your grab chain strainer (A2210) at the top, middle and bottom for even tension.



Specifications

Quick fit wedges make straining wire quick and easy. Simply place the wire over the tubular sections and hammer the wedges in, clamping the wire in place. Once strained the clamps can be quickly and easily knocked out.

- Painted fluorescent orange, easily visible in the field
- Frame is manufactured from 5mm flat high tensile steel
- 32mm dia x 4mm thick seamless tube clamp bar
- High tensile strength 370-500 N/mm² to BS 080A15
- Dee shackle straining point supplied hot dip galvanised
- Wedges 12.5mm thick, zinc plated

- All models are manufactured from heavy duty, high tensile steel.

Size	Code
Stock 1.0m - 3 tensioning points	A2220
Horse 1.3m - 4 tensioning points	A2225
Deer 2.0m - 4 tensioning points	A2230

CLIPEX[®] Steel Posts

+



Netting



=

+



TRIPLE X Strainers



STRONGER FOR LONGER

Find out more ▶



Netting Tools & Clips

Netting Pliers – Rapid 22

A1145



- Spring loading cartridge
- Magazine capacity - 50 pre-formed clips
- Hog ring diameter 5-11mm

Netting Clips – M Ring (Hog Ring)

A1146



- Galvanised Steel 2.0mm
- Open: 20mm (W) x 11mm (H) x 2mm thick
- Closed: 10mm wide (outer), 5mm (inner)
- 1600 per box

Netting Pliers - CL22 RP22

A1210



- Spring loaded, automatic feed for one handed speedy operation
- Magazine capacity - 50 pre-formed clips
- Forms a 6-8mm triangular ring

Netting Clips – CL22 RP22

STAINLESS STEEL: A1224
GALVANISED: A1222

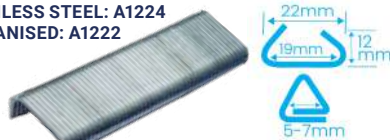

- Galvanised and stainless steel options available
- Wire gauge: 1.83mm (15 gauge)
- Open: 19.05mm (3/4") Crown
- Closed: 6.35mm (1/4")
- 1000 per box

Netting Pliers – SR8

A1120



- All steel design with a spring-loaded magazine capacity - 50 pre-formed clips
- Forms a circular clip

Netting Clips – SR8

A1110



- Wire gauge: 1.52mm (16 gauge)
- Open: 17.46mm (11/16") Crown
- Closed: 7.14mm (9/32") Diameter
- 2500 per box

Netting Pliers – CL37

A1140



- Magazine capacity - 25 pre-formed clips
- Forms a triangular ring

Netting Clips – CL37

A1130



- Aluminium mild steel
- Wire gauge: 3.75mm (9 gauge)
- Open: 30.18mm
- Closed: 11.11mm triangular shaped clip
- 3000 per box

Weld Mesh Manual Netting Pliers – CL35

A1257



- Solo manual single clip fencing tool
- Designed for low to medium service life and easy maintenance
- Use with loose clips

Weld Mesh Netting Clips Loose Galvanised – CL35

A1259



- Hot dip galvanised
- Clip is 19mm wide x 20mm deep when open
- 12mm dia circle when closed
- 1000 loose per box.

CL35 Clip Gun - CL35

A1250



- Can be used for tree guards, bird control, fruit and rabbit netting
- Suits our CL35 netting clips
- Heavy duty construction for everyday use

Weld Mesh Stainless Steel Netting Clips - CL35

A1255

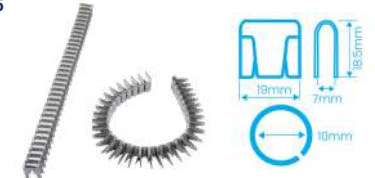

- 19mm wide x 20mm deep when open
- 12mm dia circle when closed
- Supplied in pre-formed strips for easy loading
- 1224 per box

Staple install guide



Below, the do's and don'ts when installing fencing staples.

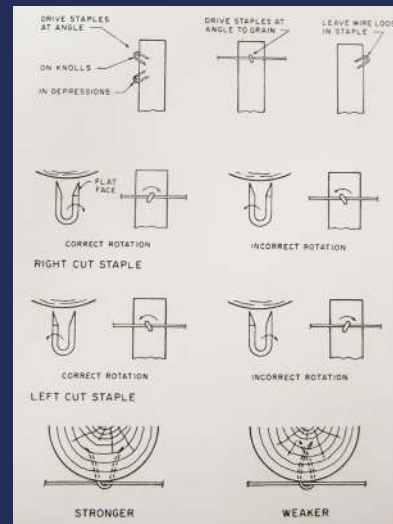

Staples

- Indented design for greater holding
- Heavily galvanised for longer life
- Sharp long pointed points for easier driving



Dimensions	Per Box	Code
25mm x 2.60mm	486	FX2201
30mm x 3.55mm	226	FX2301
40mm x 4.10mm	136	FX2401

Barbed Staples

FX2607

- For increased holding and use with high tensile or spring steel we recommend using barbed staples
- 40mm x 4mm barbed staples



Nails & Screws

Nails

Available in both round head and spring head options supplied in 1kg bags.

- Available in a range of different sizes
- Heavily galvanised for longer life
- Sharp long pointed points for easier driving

Dimensions	Style	Per Kg Bag	Code
65mm x 2.65mm	Round Head	216	FX1451
75mm x 3.75mm	Round Head	187	FX1501
100mm x 4.0mm	Round Head	101	FX1001
125mm x 5.0mm	Round Head	51	FX1701
150mm x 6.0mm	Round Head	31	FX1901
65mm x 3.35mm	Spring Head	140	FX3001

Round Head Nail

Spring Head Nail

Nail Plates FX3200

Add strength to your wooden posts with our nail plate strengthening post tops.

Nail plates help to reduce natural splitting, especially in Chestnut products.

- Add strength to wooden posts
- Also used to build/reinforce simple structures
- Currently available in 2 sizes



Carpenter Mate Screws FX6415

The Carpenters mate Pro Hex Head Screws are specialized fasteners designed primarily for heavy-duty timber construction. Known for their durability and strength, they're particularly popular among professionals in fields like decking, and fencing, as well as among DIY enthusiasts looking for reliable, long-lasting screws.



Sizes Available:

- 90mm
- 140mm
- 190mm

Tek Screws FX6003

Self Drilling Screws or Tek Screws enable the assembler to quickly attach materials such as steel, aluminium, composites or timber to steel section, or similar, up to 35mm thickness without the need for any pre-drilling or thread tapping.

- Various styles available



Masonry Screws FX3005

A versatile mechanical anchor that performs well in a wide variety of building materials. Advantages A mechanical fixing with no expansion stress on substrate.

- A mechanical fixing with no expansion stress on substrate.
- Fixes close to the edge.
- Self tapping thread allows for total removal of the anchor making it ideal for temporary fixings.



Digging

Economy Post Hole Digger A2320

- Lightweight economy post hole digger
- Wooden handles
- 150mm x 450mm blade
- Our most popular post hole digger
- A must for contractors



Roughneck Post Hole Digger A2303

- 1650mm long
- 240mm x 450mm blade
- Strong construction
- Our most popular post hole digger
- A must for contractors
- Get deeper with hinged arms



Insulated Post Hole Digger A2318

- Product handle - 48" solid core fibreglass BS8020:2011
- Product size - 7" dia X 10.1/2" blade
- 60% fibre in the solid fibreglass core handles, nearly 50% more than cheaper makes



Insulated Post Hole Digger A2301

- Fully insulated BS8020:2011
- Scissor action
- New improved design
- A must for fencing contractors
- 1220mm (48") solid fibreglass handles
- 32mm (1.2") diameter handles
- 3200mm x 650mm (7.8" x 2'1") blade size



Insulated Crowbar Chisel and Point A2358

- 32mm solid core fibreglass BS8020 handle
- 1524mm (60") overall height
- 60% fibre in the solid fibreglass core handles, nearly 50% more than cheaper makes
- Solid forged heads
- Strongest in the industry



Insulated GPO Post Hole Graft A2353

- Blade size - 125mm x 300mm (5' X 12")
- Handle - 1350mm (54") solid core fibreglass handle
- 60% fibre in the solid fibreglass core handles, nearly 50% more than cheaper makes
- Solid forged heads
- Strongest in the industry



NEED MORE INFORMATION?

Use our spec sheets to find out more



Click the link to view our full spec sheet list

Insulated Navy Pick
A2355

- Suitable for breaking up hard ground
- Weight 7lb
- 914mm (36") handle
- 60% fibre in the solid fibreglass core handles, nearly 50% more than cheaper makes
- Solid forged heads
- Strongest in the industry



Insulated Clay Graft
A2351

- 28" polyfibre shocksafe insulated handle
- 152mm x 304mm (6" x 12") blade
- 60% fibre in the solid fibreglass core handles, nearly 50% more than cheaper makes
- Solid forged heads
- Strongest in the industry



Other Tools

Galvanised Spinning Jenny Wire Dispenser
A2200

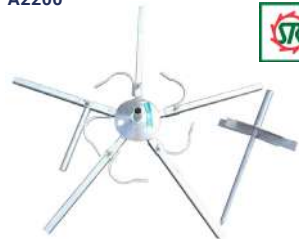

- A heavy duty design, electroplated finish, high quality 'Spinning Jenny' wire dispenser is an essential tool when handling wire coils
- The fully welded box section construction is sturdy heavy duty with a central ground spike
- The brackets adjust by a simple wing nut operation to the diameter of the coil. Not only is dispensing wire made easy, it can also be used for recoiling old wire.

Collapsible Spinning Jenny Wire Dispenser
A2201



- A heavy duty design, electroplated finish, high quality 'Spinning Jenny' wire dispenser is an essential tool when handling wire coils
- Sturdy heavy duty with a central ground spike
- Can also be used for recoiling old wire.

 More wire dispensers available in the Strainrite range

STRENGTH, IT ALL STARTS WITH THE WIRE



- 24% stronger knot
- Zinc/ aluminium coating
- Last 3-4 times longer
- Primary metals only used
- 450mm pre-stripped ends
- Exceeds BS EN 10244 Class A

PREMIUM, WORLD - LEADING WIRE, GIVING YOU THE BEST RETURN ON YOUR INVESTMENT



Click link to view X fence netting range



See pages 11 to 21 for our X fence wire netting range

MULTI-AWARD WINNING FENCING SOLUTION, TRIED, TESTED, PROVEN

CLIPEX



How Big is Your Field Perimeter?

With the easy to use charts below calculate your field perimeter, then how much fencing is needed to enclose the space.

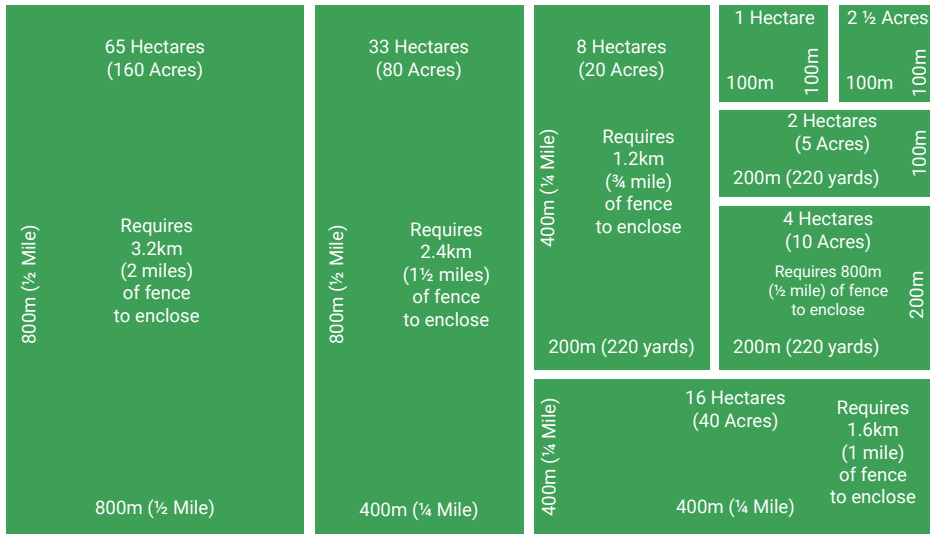

Distances and areas are approximate only.

Fence Perimeter Length Calculator

Hectares	Acres	Fencing Required in Metres
0.1 hectares	1/4 acre	= 127 metres
0.2 hectares	1/2 acre	= 180 metres
0.3 hectares	3/4 acre	= 220 metres
0.4 hectares	1 acre	= 255 metres
0.81 hectares	2 acres	= 360 metres
1.21 hectares	3 acres	= 441 metres
1.62 hectares	4 acres	= 509 metres
2.02 hectares	5 acres	= 569 metres
4.05 hectares	10 acres	= 805 metres
8.09 hectares	20 acres	= 1141 metres
16.19 hectares	40 acres	= 1609 metres
20.24 hectares	50 acres	= 1800 metres

How Many Staples per Kilo?

Our customers ask us all the time how many staples they get per kilo. The table below hopefully answers a lot of those questions.

Staple Description	Staples Per Kilo
15 x 1.6mm Staples	2191
20 x 2.0mm Staples	1079
25 x 2.65mm Staples	486
30 x 3.35mm Staples	226
40 x 4.0mm Staples	136
50 x 5.0mm Staples	70
40mm Barbed Staple	136
30mm Barbed Staple	226



Wire Gauge Chart

Wire Gauge Tip: The bigger the number the smaller the wire gauge

Wire Gauge	*Wire Diameter
8	4.00mm
10	3.15mm
12	2.50mm
14	2.00mm
16	1.60mm
18	1.20mm
19	1.00mm
20	0.90mm
22	0.70mm

*Wire gauge diameters are an approximate

STILL NOT FOUND WHAT YOUR LOOKING FOR?

Check out our full range using the link below





McVeigh Parker has eight nationwide branches all staffed by experienced teams offering great advice and customer service

Berkshire

Southend, Bradfield,
Reading, RG7 6HA

Tel: 01189 744777

Email: berks@mcveighparker.co.uk

Cambridge

Caxton Depot, Ermine Street,
Caxton, CB23 3PG

Tel: 01954 714110

Email: cambs@mcveighparker.co.uk

Devon

Muxbeare Lane, Uffculme, Cullompton,
Devon, EX15 3BY

Tel: 01884 824486

Email: devon@mcveighparker.co.uk

Kent

Thornden Farm, Lenham Road,
Headcorn, TN27 9LH

Tel: 01622 891095

Email: kent@mcveighparker.co.uk

Lancashire

Park Lane Industrial Estate, Wigan Road,
Ashton-in-Makerfield, Wigan, WN4 0BZ

Tel: 01942 725523

Email: lancs@mcveighparker.co.uk

Scotland

Market Road, Biggar,
Lanarkshire, ML12 6FX

Tel: 01899 221150

Email: scotland@mcveighparker.co.uk

Sussex

Stane Street,
Billingshurst, RH14 9JR

Tel: 01403 784250

Email: sussex@mcveighparker.co.uk

Worcestershire

Unit 16, Wilden Lane Industrial Estate,
Stourport on Severn, DY13 9JY

Tel: 01299 826111

Email: worcs@mcveighparker.co.uk