



A Long-Life Fencing Solution
From McVeigh Parker

mp **McVeigh Parker**
Farming and Fencing Specialists

www.mcveighparker.com



mp McVeigh Parker

Farming and Fencing Specialists

UK specialist suppliers of fencing and agricultural products

McVeigh Parker was founded by Michael McVeigh and Brian Parker in 1979. The company has grown significantly since its inception in Berkshire over 40 years ago. We are now one of the premier specialist agricultural and fencing stockists in the UK, with eight large depots all staffed by knowledgeable, experienced people spread across the whole country. We have a dedicated team of Key Account Managers who not only look after our many trade clients, they can also visit your site to help plan and design your next fencing, livestock handling or feeding system project.

McVeigh Parker are ISO 9001, 14001 and 18001 certified as well as Achilles and FSC registered which means customers can be confident that they are dealing with a highly reputable and well-regarded supplier that has passed stringent industry tests.

We have been selling fencing for generations and have learnt that there is no such thing as a one size fits all approach to the budget or job. We hold over £8m of stock and keep a full range of farming and fencing products in our 8 depots, ready for immediate supply. Our bulk buying policy means customers benefit from the significant savings our buying power generates. We run our own fleet of over 50 vehicles delivering a fast, efficient and reliable service right across the country.

We have earned a reputation for innovation, expertise and competitive pricing, and are constantly looking at better, more advanced products that offer a greater return on investment. We have a proven track record delivering to major organisations such as Network Rail, National Trust, Environment Agency, RSPCA, RSPB and many others.

In keeping with our spirit of innovation, we have brought together some of the best products in the market to offer you Triple X, a complete fencing solution, that will withstand all our weather can throw at it for much longer than timber alternatives.

Chris Hambridge
Director, McVeigh Parker



Contents

What is Triple X?	5
The Triple X Fencing Benefits	8
Clipex® All Steel Post Specifications	9
Post Strength & Specifications	10
UK Clipex® Range	12
Triple X All Steel Strainers	
Triple X All Steel Strainer	14
Strainer Components	16
30 Year Guarantee	17
X Fence Premium Wire	
About	18
Manufacturing	19
Compatible Wire	20
Triple X Case Studies	22
Bespoke Case Studies	32
Line Wire Systems	41
Line Wire Alternatives	42
Installation	45
Product Guide	46
Accessories & Tools	47
FAQs	50
Get In Touch	52

Visit us online

Today more than ever there is a need to be able to access products quickly on demand, and people expect delivery to be efficient. Our website has developed and improved hugely over the past few years in order to accommodate our customers' needs. Online ordering is simple and secure. We run our own delivery fleet and also use national couriers for a reliable service. Plus the site offers a wealth of information, videos and specification sheets of our large range of products.



Straightforward navigation



Easy shopping



Mobile & tablet friendly



Register for an online account



“Fencing for the next generation”

MULTI-AWARD WINNING FENCING SOLUTION, TRIED, TESTED, PROVEN.

Triple X is the name we've given to an all-steel fencing system using the revolutionary Clipex® steel post with X Fence premium wire netting and Triple X all steel strainers plus a choice of barbed, plain or electric wire.

This is a fencing system like no other and can offer up to 50% cost savings over a more traditional fence. It is a fence with a life expectancy exceeding 30 years, takes significantly less time to erect, cutting both labour and machinery costs.

So, before you make the important investment decision on your next fencing project, contact a member of the McVeigh Parker team. We are confident that we can offer you a solution that is cost-effective, sustainable and much longer lasting than traditional systems.

- Long-life fencing solution
- Faster to erect and lighter to transport
- Lower carbon footprint
- Strong premium long-lasting wire netting
- Up to 50% lifetime savings
- Proven in the field
- Multi-award winning
- All netting lines securely held
- Used by many leading organisations
- No stapling required
- No fiddly loose components
- Minimal ground disturbance
- 30 year guarantee
- Strainers made in Britain

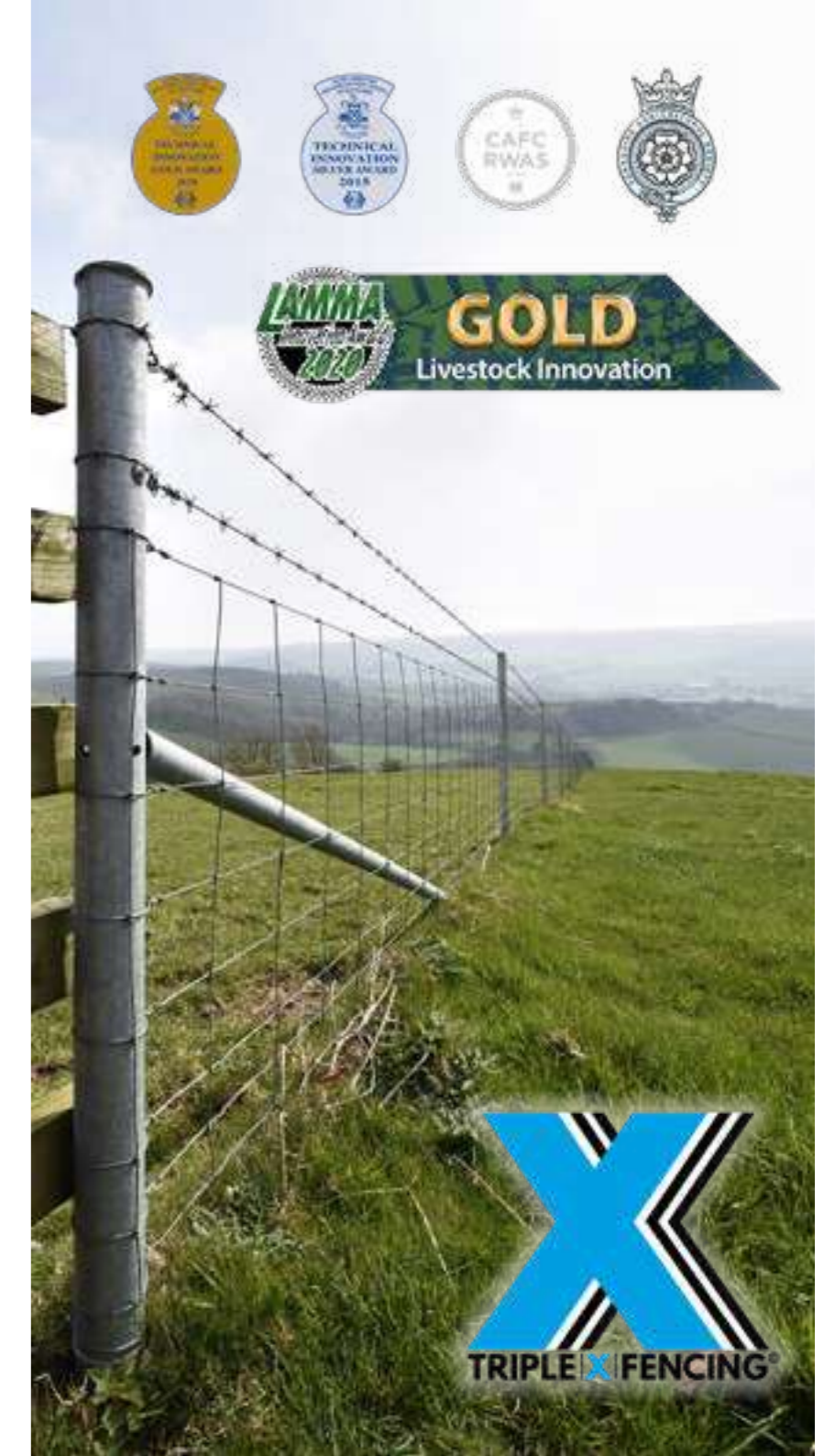

Steel vs Wood: A guide to fence posts

Deciding on the type of new or replacement fence for your land is no longer as straightforward as it once was. Especially when trying to weigh up the pros and cons of wooden and steel fence posts. Factors that are worth considering are practicality, aesthetics, short and long term costs and more and more important these days, sustainability.

Durability

The service life of a fence line must be the main priority when considering your options. There is no longer any need to gamble with the expected service life of timber posts, no need to accept carcinogenic leaching, no more stapling, no fiddly components to install or lose. Triple X will reduce machinery and labour costs, is lightweight yet extremely strong.



Costs

With costs, it can be tempting to focus on the short-term. Initially a cheaper timber and hinge jointed wire fence might seem appealing. However, it may need replacing 2 or 3 times in the 30 years minimum life we expect from the Triple X system. Although Triple X fencing can incur slightly higher initial costs when compared to timber, the long-term cost per metre, per year of life is far more economical. The 30-year guarantee, strength and durability offered by our all steel fence system means it will need only minimal maintenance over its lifetime. The very latest manufacturing techniques and innovative design with efficient management enable McVeigh Parker to offer the Triple X fencing solution at a very realistic price.

Aesthetics

Although the look of a fence really is a matter of personal preference, wooden fence posts may have a more traditional rustic appearance and steel has been seen as potentially a little cold and industrial. The actual appearance of our steel system is a long way from this harsh impression. The slimline profile of the posts has less impact in the countryside than timber. In extremely sensitive areas we would recommend a matt black paint is applied after installation, the fence will then better merge into the landscape.



Sustainability

With increasing awareness of the environmental impact of agriculture, opting for a sustainable fencing system is becoming a major priority amongst farmers, landowners and utility companies. Whilst a lot of timber is obtained from sustainable sources, the process still involves cutting down trees. The treatment of timber can be harmful to eco systems not only from their initial use but also from the disposal. Triple X fencing is a far more sustainable option, no chemical contamination of the soil, lighter and easier to transport, it is also fully recyclable at the end of its life. These factors mean the overall carbon footprint of Triple X has been shown to be lower when considering manufacture, transport, installation machinery, labour and finally disposal costs.

Installation

Triple X fencing is lighter, takes up a lot less storage space and is easier to transport. It can be installed quickly and easily, no specialist tools are required, driving the posts can be done manually or with the aid of a hand-held petrol post driver and an auger for strainers. This means significantly less ground compaction from heavy machinery. Due to the size and weight of the components, fewer workers and less machinery are required, reducing a lot of project management time on the fencing line.



Security

Every intermediate post has a pre-welded anti-lift plate, once the post is driven in, these go below ground. The plate acts like a barb and prevents the post from lifting, it also acts as a deterrent to thieves, making it extremely difficult to lift the post. Intermediate posts also have backing plates for added strength. All our posts are designed to clip EVERY wire of the fabricated X Fence netting. These are held in place by a spring-loaded fixed clip. These self-locking clips restrict any longitudinal movement, whilst allowing lateral movement to enable the netting to flex, no pressure is actually put on the clip. Abrasion to the wire and posts caused by livestock movement is not an issue as the netting is protected by the sacrificial coating of the alu/zinc wire used in the fabrication of X Fence.



- Clipex® the multi-award winning innovative galvanised steel post.
- Each post has pre-fixed clips designed to take all the horizontal wires of your chosen X Fence wire netting.
- Each wire is held firmly in place with a spring-loaded clip, no fiddly parts to lose or fit after erection.
- These clips allow lateral flex, but very little vertical wire movement can happen, which is important when livestock start putting pressure on the fence.
- Each post has a pre-fixed anti-lift plate below ground level to prevent lifting in soft or undulating ground.
- Hot dip galvanised and independently tested in the UK, exceeding British Standard coating recommendations.

- **Galvanised coating exceeds British Standard BS EN ISO 1461**



- X Fence premium X knot fabricated wire netting – buying quality wire is key to any good fence.
- The unique properties of X Fence make it stronger and last longer.
- The high tensile wire properties and one-piece vertical wire reduce the amount of support posts needed, leading to a saving in labour and materials.
- Only primary metals used in fabrication.
- 24% stronger knot.
- Alu/zinc coating lasts 3-4 times longer than heavy galvanised wire.
- Full traceability from source to field.
- Many Clipex® compatible mesh patterns stocked (more patterns available for other uses).

- **X Fence is manufactured to BS EN 10223-5**
- **Alu/zinc coating exceeds BS EN 10244-2**
- **Dimensions & tolerances conform to BS EN 10218-2**

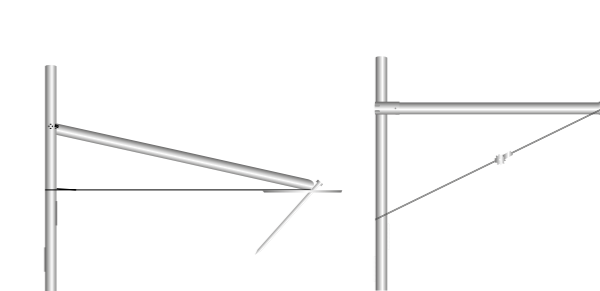

- Triple X Strainers are British made all steel hot dip galvanised, with fully-welded base and thrust plates, fully-welded top cap and pre-drilled holes for ease of strut installation.
- The 3.2mm thick strainer allows them to be driven in hydraulically or mechanically.
- Diagonal or box strainer versions available, whichever best suits your requirements and budget.
- Installing a Triple X strainer could not be simpler. Minimal components mean full installation in less than 5 minutes is possible.

- **Galvanised coating to British Standard BS EN ISO 1461**



The Triple X Fencing Benefits



FASTER

- Up to 50% quicker to erect
- No stapling required
- Posts are quicker to drive in
- Less maintenance, saves time



EFFICIENT

- No fiddly loose components
- Easier to transport to site
- Takes up less storage space
- No specialist tools required



SAVINGS

- 50% savings are possible over the fence life
- Less machinery and labour needed
- Health and Safety costs reduced
- Save on staples, hammers, pneumatic tools and generators

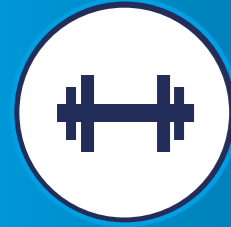

STRONGER

- Better strength to weight ratio
- High tensile steel allows flex
- Two profile options to create a stronger fence



SECURITY

- Anti-lift plate prevents easy removal, and anchors the fence
- Used with X Fence it creates a formidable barrier
- All X Fence lines are held in place
- Longer lasting stability



TOUGHER

- Stainless steel rivets applied by 10t press
- Unique spring loaded clip locks all wires in place
- Fully automated weld for added strength



ENVIRONMENTALLY FRIENDLY

- Lower carbon footprint
- Minimises ground disturbance
- No chemical leaching
- Lighter and easier to transport
- Fully recyclable



LONGEVITY

- Hot dip galvanised to British Standards
- All steel construction
- Very low maintenance
- Aluminium keep with a stainless steel spring



INNOVATION

- Multi-award winning patented design
- Designed for purpose
- Full technical and consultation support
- Bespoke design and projects catered for

CLIPEX
FENCING



All Steel Post

Specifications

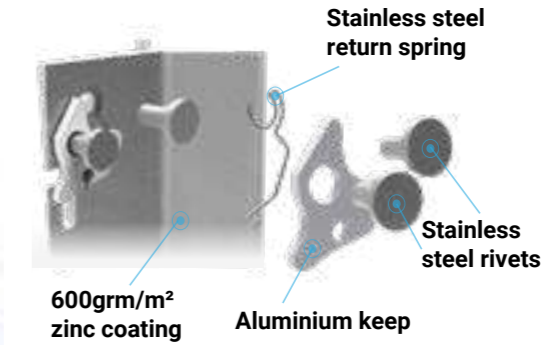

Clip
Self-closing spring loaded clip guarantees a secure fixing for your wire. The clip itself is coated with proprietary aluminium to avoid any electrolysis between the fencing wire and the clip.

Backing plate

All our Clipex® posts feature a backing plate at ground level, to give the posts strength where it matters most.

Automated weld

Each post now has an automated weld at the top to guarantee that the post won't split when being driven with pneumatic drivers into rocky ground.

Anti-lift plate

All Clipex® Standard and Beefy posts are fitted with the unique anti-lift plate, which acts as a barbed anchor underground.

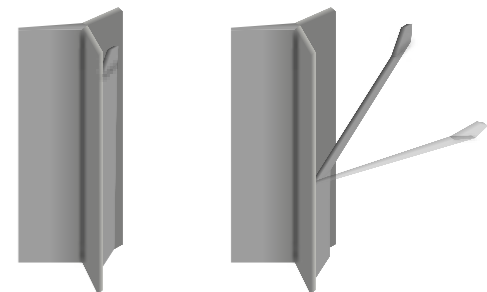

Post Strength & Specifications

Eco Post

The Clipex® Eco post has been specifically designed as an entry level post to suit the most popular hinge jointed stock fence, plain or barbed line wire applications.

Eco posts have been designed to suit hinge jointed 8-80-15 or 8-80-30 products with two rows of barbed or plain wire. The clips may suit some other fence patterns.

Manufactured from high tensile steel with a 600g/m² galvanised coating which ensures a longer life.

Note: Please check mesh pattern against posts BEFORE installation, especially important if you are trying to match your own netting.

Standard Post

The Clipex® Standard post is higher quality than the Eco post, it is manufactured from high tensile steel with a 600g/m² galvanised coating which provides a longer life with minimal maintenance. Made using a unique cutting edge process which guarantees a high precision product every time.

Standard stock fence posts are designed to suit X Fence XHT8-80-15, XHT8-80-22, XHT8-80-30 with two rows of barbed or plain wire above and one base line below. The cattle/railway/horse Standard posts are designed for XHT11-122-7.5, XHT11-122-15 with one top row and one base line of barbed or plain wire.

Standard deer posts are designed to take XHT13-190-7.5, XHT13-190-15 with one top line of plain or barbed wire.

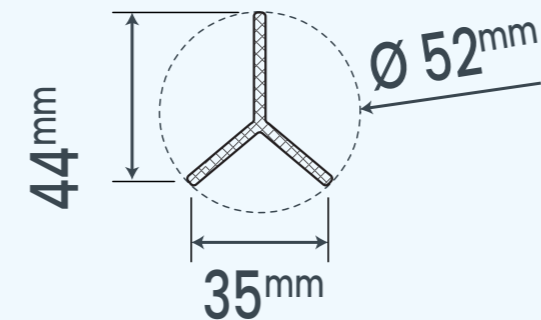

CLIPEX
FENCING

Beefy Post

The Clipex® Beefy post is specifically designed to add ground holding and strength to your fence line where it matters. It has a thicker profile than the Standard and Eco posts which gives it an increased surface area in the ground, as well as reducing any twisting. The increased profile also improves the lateral strength.

The Beefy posts have a better strength to weight ratio with 60% greater surface area providing 230% more strength than smaller profile posts. This along with the 600g/m² galvanised zinc coating, anti-lift plate, thicker gauge, high tensile steel and longer length make the Beefy an unbeatably strong and durable post.

When should you use a Beefy post?

We recommend their use in softer soils, high stock pressure areas, dividing paddocks, and peaks and troughs in undulating ground, as well as slight changes in a fence line of less than 15°. You can also combine with a Beefy bracket and strut for a cost effective angled support.

A combination of Standards and a Beefy every third or fourth post will strengthen your fence line. Or you can use all Beefy posts to provide a strong formidable, long-lasting fence that will offer many years of maintenance-free life.

Important advice:

If to be used as a cattle or horse fence we highly recommend using either Clipex Beefy posts which are more able to stand the stock pressure or an electric top line to avoid any pressure on the fence.

Since conditions of use and location are beyond our control, purchasers must accept responsibility for satisfying themselves that the product is fit for their intended purpose and location.

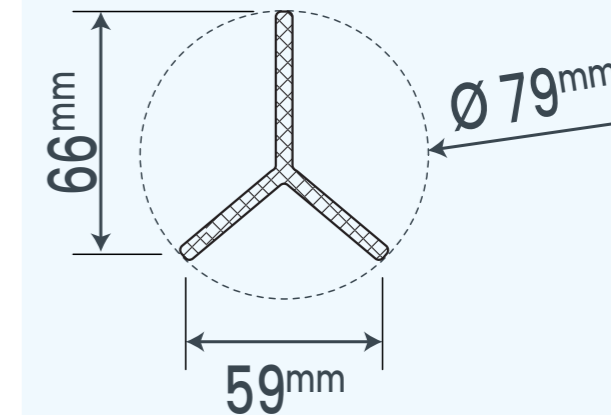
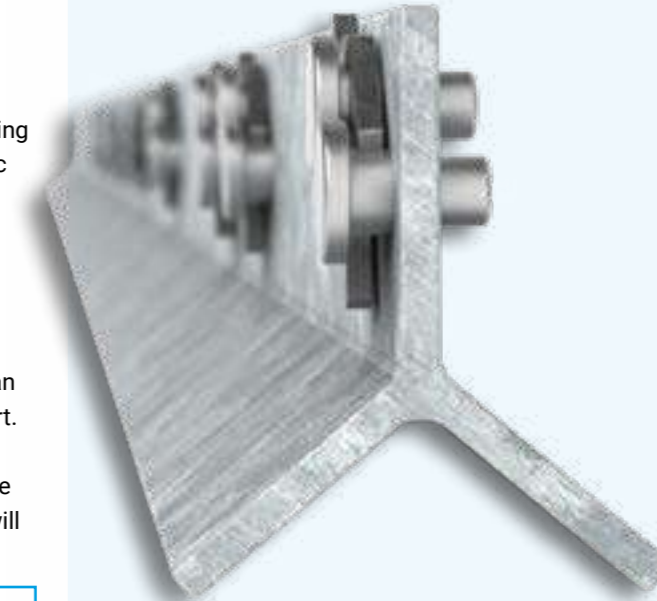
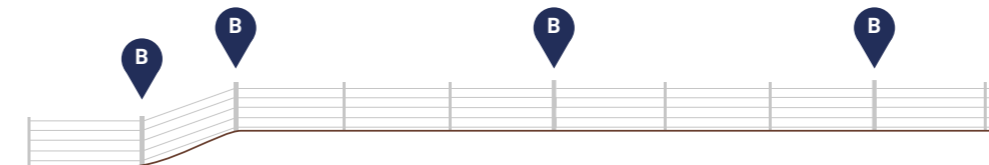

CLIPEX
FENCING



Pasture post Eco post Standard/Beefy post

Did you know?

- Electric insulators can be retro-fitted to any spare clip on any post
- Clipex® caps can be added to any post for added safety
- They also have the facility to take electric tape/rope or wire

SEE PAGE: 47

Did you know?

- You can lengthen or extend any post now with the vertical extension kit

SEE PAGE: 47

Pasture Eco - 4 Clips

- Length: 1.5m
- Weight: 2.16kg
- In ground depth: 600mm (fence height - 900mm)
- Profile: 44mm x 35mm
- Thickness: 2.5mm

CL2705

Pasture Beefy - 4 Clips

- Length: 1.5m
- Weight: 5.25kg
- In ground depth: 600mm (fence height - 900mm)
- Profile: 66mm x 59mm
- Thickness: 3.5mm

CL2708

- Compatible wire**
- Electric rope/wire
 - Barbed wire
 - Line wire

Eco - 10 Clips

- Length: 1.8m
- Weight: 2.59kg
- In ground depth: 720mm (fence height - 1.08m)
- Profile: 44mm x 35mm
- Thickness: 2.5mm

CL2710

Standard - 11 Clips

- Length: 1.8m
- Weight: 3.24kg
- In ground depth: 700mm (fence height - 1.1m)
- Profile: 44mm x 35mm
- Thickness: 3.0mm

CL2715

- Compatible wire**
- Hinge joint 8-80-15
 - Hinge joint 8-80-30
 - Line wire
 - Barbed wire
 - Electric rope/wire

Standard - 11 Clips

- Length: 1.8m
- Weight: 3.24kg
- In ground depth: 700mm (fence height - 1.1m)
- Profile: 44mm x 35mm
- Thickness: 3.0mm

CL2715

Beefy - 11 Clips

- Length: 2.0m
- Weight: 7.0kg
- In ground depth: 900mm (fence height - 1.1m)
- Thickness: 3.5mm
- Profile: 66mm x 59mm

CL2720

- Compatible wire**
- X Fence XHT8-80-15
 - X Fence XHT8-80-22
 - X Fence XHT8-80-30
 - Line wire
 - Barbed wire
 - Electric rope/wire

Rock post Cattle/Railway post Deer post

Rock - 11 Clips

- Length: 1.4m
- Weight: 4kg
- In ground depth: 250mm (fence height - 1.1m)
- Profile: 44mm x 35mm
- Thickness: 3.0mm plus 20mm Re-bar footing

CL2716

- Compatible wire**
- X Fence XHT8-80-15
 - X Fence XHT8-80-22
 - X Fence XHT8-80-30
 - Line wire
 - Barbed wire
 - Electric rope/wire

Standard - 13 Clips

- Length: 2.0m
- Weight: 3.60kg
- In ground depth: 650mm (fence height - 1.35m)
- Profile: 44mm x 35mm
- Thickness: 3.0mm

CLR2710

Beefy - 13 Clips

- Length: 2.1m
- Weight: 7.35kg
- In ground depth: 750mm (fence height - 1.35m)
- Profile: 66mm x 59mm
- Thickness: 3.5mm

CLR2720

- Compatible wire**
- X Fence XHT11-122-15
 - X Fencehorse XHT11-122-7.5
 - Line wire
 - Barbed wire
 - Electric rope/wire

Standard - 14 Clips

- Length: 3.0m
- Weight: 5.40kg
- In ground depth: 900mm (fence height - 2.1m)
- Profile: 44mm x 35mm
- Thickness: 3.0mm

CL2725

Beefy - 14 Clips

- Length: 3.0m
- Weight: 10.5kg
- In ground depth: 900mm (fence height - 2.1m)
- Profile: 66mm x 59mm
- Thickness: 3.5mm

CL2730

- Compatible wire**
- X Fence XHT13-190-15
 - X Fence XLHT13-190-15 (light)
 - X Fence XLHT13-190-7.5 (light)
 - X Fence XHT13-190-7.5
 - Line wire
 - Barbed wire
 - Electric rope/wire

Please note diagrams not to scale

We recommend the use of a CAT scanner before fence installation

Triple X All Steel Strainer

Triple X Strainers have been designed by McVeigh Parker and are proven in the field throughout the UK. Used by contractors, utility companies, farmers and landowners for stock, deer and security fencing.

Our British made strainers are a very good alternative to more traditional timber strainers, lasting much longer and saving significant installation and labour time. When teamed up with the Clipex® posts and our premium quality X Fence alu/zinc wire netting you have a fencing system that has a life expectancy of over thirty years.



Benefits

- Simple and quick installation in under five minutes
- Cost-effective over the lifetime of fence
- Guaranteed to exceed a 30 year life
- Diagonal or Box strainer kits available to suit all terrain and soil
- Only five components, easy to assemble, no fiddly parts to install or lose
- Exceptionally strong, fully welded top cap, the thick-walled tubular strainer can be mechanically or hydraulically driven
- Fully welded 6mm thick breast and thrust/directional plates
- Hot dip galvanised in the UK to BSEN ISO 1461
- Easy transportation (reduces carbon footprint)
- Pre-drilled holes to take multiple struts for two way and corner strainers
- Two lengths to choose from which suit various fence heights
- Corner plate available for retro-fit to create 90° angle

Dimensions of concrete foundations in soft/wet ground

When installing a strainer in soft/wet ground, especially for a railway or highway project, we recommend the use of a concrete foundation.

Soil conditions vary widely and are also dependent on the time of year. We advise using the dimensions shown as a minimum.

We have created an anti-lift plate for those in particularly soft ground that are concerned about the possibility of lifting. This can be retro-fitted. Contact a member of our team for full details.

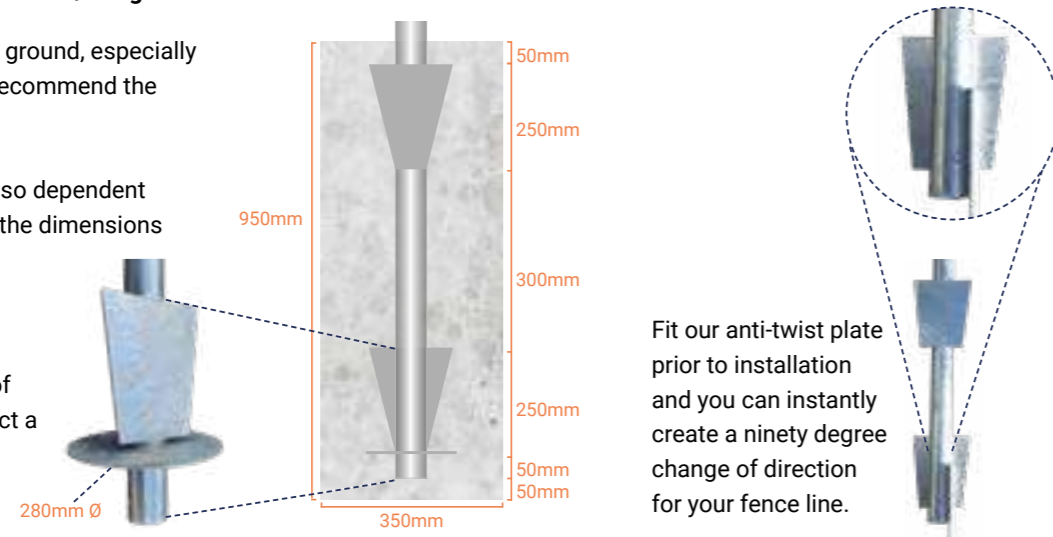

Fit our anti-twist plate prior to installation and you can instantly create a ninety degree change of direction for your fence line.



Diagonal Strainer



Corner/2 way Diagonal Strainer



Box Strainer



Box Corner/2 way

Diagonal Strainer		Box Strainer		Eco Beefy Strainer
Standard Strainer • Length: 2.4m • Weight: 18.5kg • Profile: 75mmØ x 3mm	Deer Strainer • Length: 3.3m • Weight: 27.5kg • Profile: 75mmØ x 3mm	Standard Strainer • Length: 2.4m • Weight: 18.5kg • Profile: 75mmØ x 3mm	Deer Strainer • Length: 3.3m • Weight: 27.5kg • Profile: 75mmØ x 3mm	The Eco Beefy strainer is a cost effective, simple strainer. Ideally suited for electric fence, reinforcing slight angles or a semi-temporary fencing end strainer.
Standard Strut • Length: 2.4m • Weight: 8.25kg • Profile: 48.3mmØ x 3mm	Deer Strut • Length: 3.0m • Weight: 9.01kg • Profile: 48.3mmØ x 3mm	Standard Strut • Length: 3.05m • Weight: 14kg • Profile: 60mmØ x 3mm	Deer Strut • Length: 3.05m • Weight: 14kg • Profile: 60mmØ x 3mm	
End: KCPX10 Corner/2way: KCPX20	End: KCPX30 Corner/2way: KCPX40	End:KCPX18 Corner/2way: KCPX25	End: KCPX35 Corner/2way: KCPX45	Eco Beefy Strainer: KCPX15 See page 16 for all components

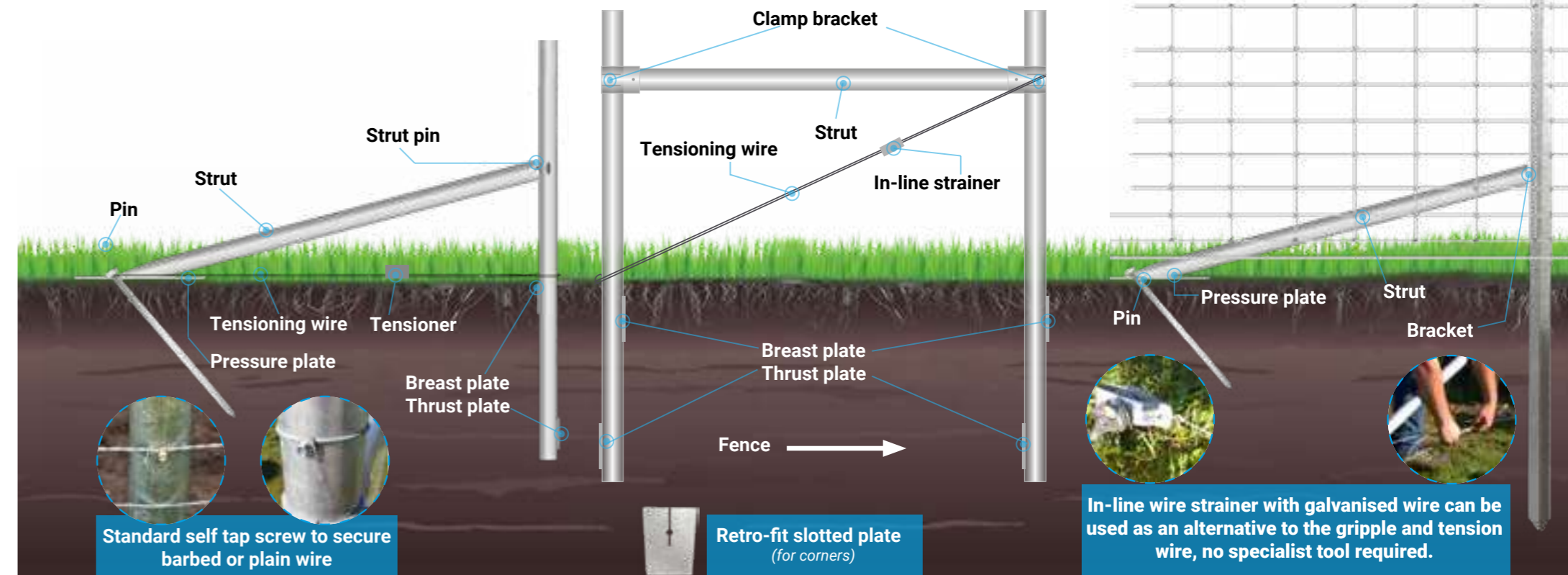

Strainer Components



Stock Fence	End Strainer	Corner/Two Way	Box End	Box Corner/Two Way	Eco End
75mm x 2.4m c/w plates [1]	1	1	2	3	
50mm strut 2.4m, hook [2]	1	2			
60mm strut 3.05m [3]			1	2	
Plate 250mm x 6mm [4]	1	2			1
Pin 750mm x 20mm dia [5]	1	2			1
Tension wire c/w Gripple [6]	1	2	1	2	1
Corner slotted plate* [4]		1 (optional)		1 (optional)	
2.0m Beefy [7]					1
2.1m nib strut [8]					1
Beefy bracket [9]					1
Claw Clamps [10]			2	4	



Deer Fence	End Strainer	Corner/Two Way	Box End	Box Corner/Two Way	Eco End
75mm x 3.3m c/w plates [1]	1	1	2	3	
50mm strut 3.0m, hook [2]	1	2			
60mm strut 3.05m [3]			1	2	
Plate 250mm x 6mm [4]	1	2			
Pin 750mm x 20mm dia [5]	1	2			
Tension wire c/w Gripple [6]	1	2	1	2	
Corner slotted plate* [4]		1 (optional)		1 (optional)	
Claw Clamps [10]			2	4	

*Can be added for additional ground support in softer soil

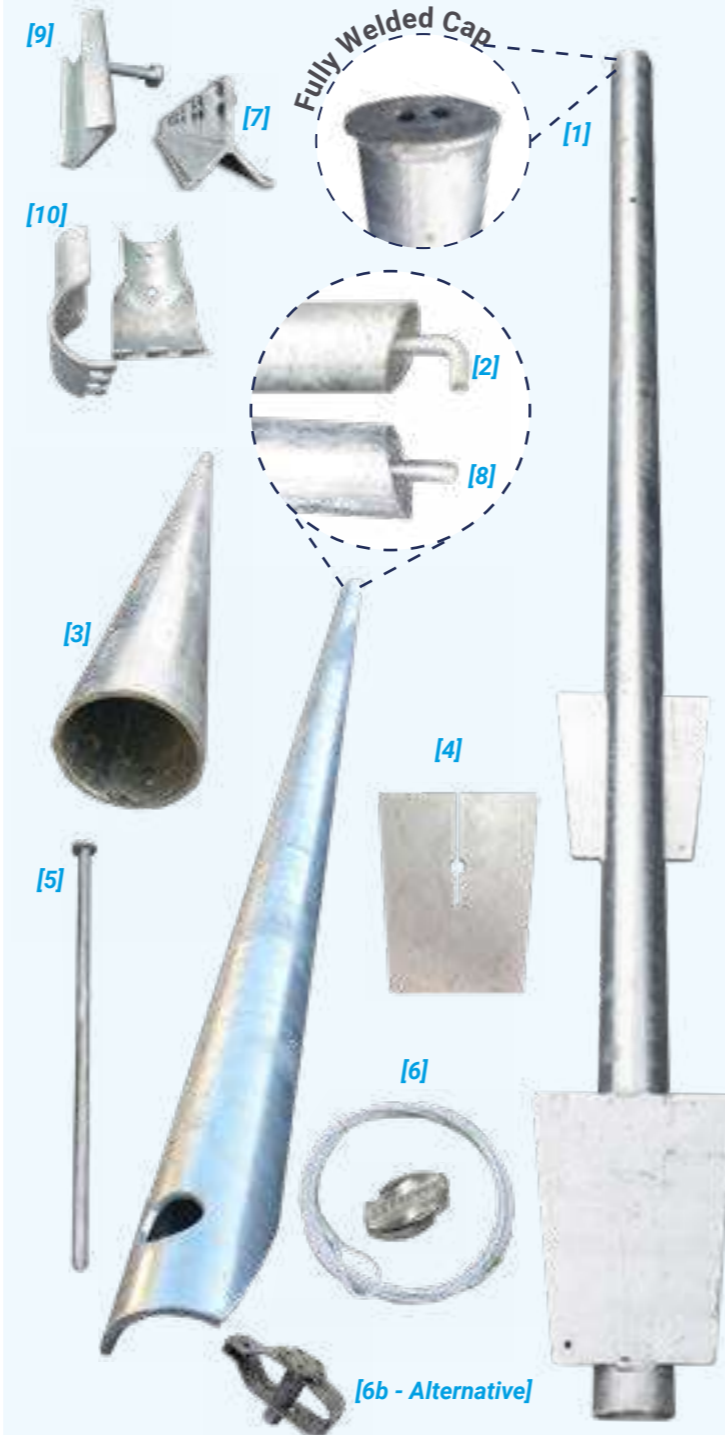

Strainer installation -
Install using post hole digger,
auger or mechanically driven.

Triple X strainer installation
is significantly less labour
intensive than the equivalent
timber strainers.

FOR MORE ON TRIPLE X
INSTALLATION SEE PAGE 45



Triple X 30 Year Service Guarantee

Clipex® posts are manufactured
in 3 gauges 2.5mm, 3.0mm and
3.5mm from high tensile 450
grade steel.

All the posts are hot dip
galvanised exceeding British
Standards. The posts have
aluminium self-locking clips
with stainless steel springs and
rivets. Combine these Clipex®
posts with X Fence wire netting
and Triple X Strainers and you
have an unbeatable fence which
is backed by a 30 Year Service
Life Guarantee, giving peace of
mind that Triple X fencing will
have a long service life, subject to
routine maintenance and industry-
standard installation.

The guarantee must be activated
at the time of purchase by the
original purchaser.

CLIPEX
FENCING

For full T&C's go to
www.mcveighparker.com/triple-x-guarantee





- Manufactured from highest quality primary metals
- 95% Zinc 5% Aluminium
- XTRALIFE coating, 24% stronger knot
- Smooth animal friendly abrasive free design forged X knot



- Tension curves absorb any pressure from climatic change or livestock pressure. Reduce the tension curves by 50% for visible tensioning
- 450mm pre-stripped ends, speeds up tying off time



- One piece uncut vertical wire
- Acts like its own intermediate, provides real strength & rigidity to the fence, almost self-supporting
- Makes installation quicker



- XTRALIFE coating makes the wire more ductile, easier to work
- Resists cracking when tying off unlike some heavy galvanised wire

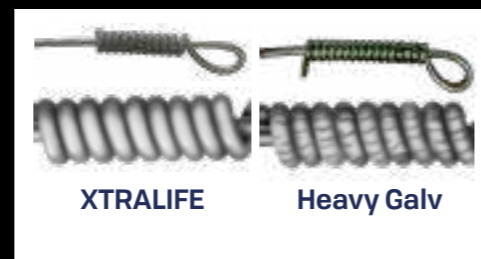

Manufacturing

X Fence is different from the rest. Premium, world-leading, giving you the best return on your investment.

It starts with the raw material – the finest high-grade 100% iron ore, free of impurities – which is then taken to world-leading processing plant to be turned into the premium steel wire used to make X Fence.

Standard galvanising processes use zinc-only coatings for the wire. X Fence is treated with a zinc/aluminium coating. Twice.

Zinc-only coatings don't provide the same levels of protection, making the steel less ductile and thus more prone to cracking when tying off. In addition to the Zinc/Aluminium coating, X Fence's special process differs from other manufacturers as it ensures an even spread, whereas many others can leave an uneven finish which allows for patchy wear and rust. As a result X Fence can give up to three times the lifespan of traditionally galvanised wire.

Batching the coiled wire also guarantees traceability and a consistent quality throughout the manufacturing process, ensuring the tensile strength variation is kept to a minimum, and providing an even tension right across the fabricated net.



Iron ore

Pouring and drawing

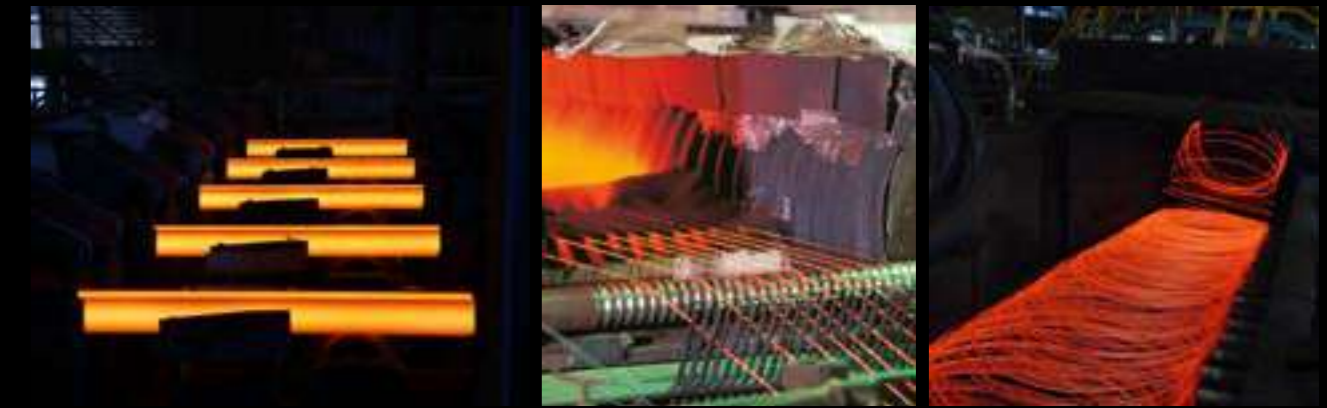

Billet to coil, coating to fabrication



Testing, rolls, to erection to final use

“The wire is only as good as the raw material it's made from”

X Fence® Premium Wire

X Fence Wire Patterns

Pattern	Length	Code
XHT8-80-15 Stock Fence	100m	F2412
	300m	F2414
XHT8-80-22 Lamb Friendly Fence	100m	F2415
	300m	F2419
	500m	F2422
XHT8-80-30 Stock Fence	100m	F2416
	300m	F2418
	500m	F2417
XHT11-122-15 Cattle/Railway	50m	F24055
	100m	F2405
XHT11-122-7.5 Horse Poultry	50m	F24062
	100m	F24065
XHT13-190-22 Deer fence	200m	F2446
XHT13-190-15 Deer fence	100m	F2440
	200m	F2442
XLHT13-190-15 Deer Fence (light)	100m	F2441
XLHT13-190 -7.5 Poultry/ Dogs/Deer (light)	100m	F2448
XHT13-190-7.5 Boar/Poultry/Badger	50m	F2450
	100m	F2452

UNDERSTANDING THE CODES

Example: 8/80/15

8= Horizontal Wires

80= Fence Height (cm)

15= Distance between vertical wires (cm)

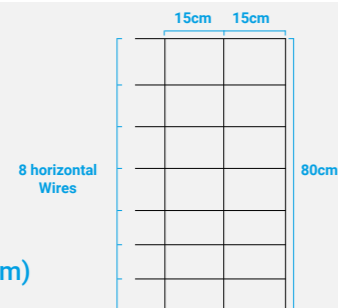

Other stocked patterns

Pattern	Length	Code
XHT10-90-7.5 Horse	50m	F2400
	100m	F2401
XHT12 -110 -7.5 Horse	50m	F2402
	100m	F2403
XHT13-125-7.5 Horse	50m	F2404
	100m	F2406
XHT13-125-5 Foal/Horse	50m	F2408
XHT15-158-7.5 Badger	50m	F2410
	100m	F2411
XHT6 - 80 - 22 Game Bird Fence	100m	F2424
	300m	F2425
XHT17-190-7.5 Badger/Boar/Deer	50m	F2454
	100m	F2455
XLHT6-50-5 Apron fence/Otter/Poultry (light)	100m	F2428
XLHT23-220-5 Hinged Apron Otter Fence (light)	50m	F2462

Other stocked patterns

Pattern	Length	Code
XHT19-180-5 Security/Tree Guards	50m	F2456
XHT26-180-5 Otter	100m	F2460
XHT17-190-15 Deer	100m	F2444



High tensile strength
1235mpa to 1550mpa



The **British Standard EN10244-2** coating lists a sacrificial zinc coat of 230gr/m². X Fence exceeds these standards with Alu/Zinc alloy coating which offers extended life protection.

TYPE	NOMINAL - HORIZONTAL WIRES	VERTICAL WIRES	COATING
XLHT - X knot light (HT)	2.0mm - 1235/1550 (N/mm ²)	2.0mm - 850/950 (N/mm ²)	Alu/Zinc
XHT - X knot (HT)	2.5mm - 1235/1550 (N/mm ²)	2.5mm - 850/950 (N/mm ²)	Alu/Zinc

Barbed Wire

BLACKMAX Bezinal Barbed Wire

- 5.4kn breaking load
- 1.6kn suitable tension
- Barb spacing 100mm
- XTRALIFE zinc/alu Bezinal coating
- Exceeds BSEN 10244-2 Class A



Line wire dia & Tensile Strength	Barb dia & Tensile Strength	Roll Length	Code
2.00mm dia - 1050-1250 N/mm ²	1.9mm dia - 440-540 N/mm ²	500m	F2013

LASTS MORE THAN 4X LONGER THAN STANDARD GALVANISED WIRE

High Tensile Galvanised Barbed Wire

- Manufactured to BSEN 10223-1
- Galvanised to BSEN 10244-2 Class A

Line wire dia & Tensile Strength	Barb dia & Tensile Strength	Roll Length	Code
2.00mm dia - 1050-1250 N/mm ²	1.9mm dia - 440-540 N/mm ²	200m	F2014
		2000m	F2015
1.6mm dia - 1050-1200 N/mm ²	1.45mm dia - 415-495 N/mm ²	200m	F2010

Mild Steel Barbed Wire 200m

F2000

- Zinc coating (HDG) 245grm
- Manufactured to BSEN 10223-1
- Galvanised to BSEN 10244-2 Class A
- Line wire dia & tensile strength: 2.5mm dia - 415-495 N/mm²
- Barb dia & tensile strength: 2.0mm dia - 415-495 N/mm²

Line Wire

High Tensile XTRALIFE Alu/Zinc Coated

- XTRALIFE alu/zinc coated high tensile line wire
- Tensile strength: 1250 -1350 (N/mm²)
- Coating weight: min 240g/m²
- Wire diameter tolerance: +/-0.04(mm)
- Alu/zinc coating which exceeds BSEN 10244-2 Class A

Gauge	Approx. Length	Code
2.50mm	610m	F2142
3.15mm	410m	F2147

High Tensile Line Wire

- Standard high tensile galvanised line wire
- Tensile strength: 1250 -1350 (N/mm²)
- Coating weight: min 240g/m²
- Wire diameter tolerance: +/-0.04(mm)
- Heavily galvanised to BSEN 10244-2 Class A

Gauge	Approx. Length	Code
2.00mm	1017m	F2104
2.50mm	651m	F2140
3.15mm	410m	F2145
4.00mm	254m	F2150

Mild Line Wire

- Tensile strength: 350 -550 (N/mm²)
- Coating weight: min 240g/m²
- Wire diameter tolerance: +/-0.04(mm)
- Heavily galvanised to BSEN 10244-2 Class A

Gauge	Approx. Length	Code
1.89mm	1190m	F2102
2.50mm	651m	F2115
3.15mm	410m	F2120
4.00mm	254m	F2125

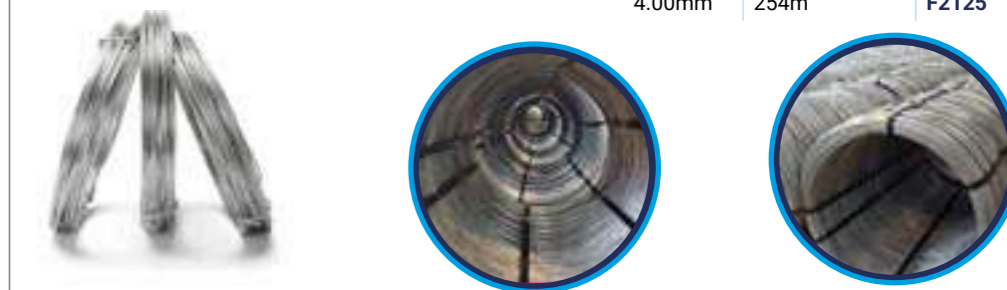

The Reel Wire - Bobbins

- Tensile strength : 1235 -1390 (N/mm²)
- Coating weight : min 240g/m²
- Wire diameter tolerance : +/-0.04(mm)
- Heavily galvanised to BSEN 10244-2 Class A

Gauge	Coil Length	Code
2.50mm	600m	F2141
3.15mm	400m	F2144



Triple X Case Studies



We believe that our exclusive Triple X fencing system is the way forward for a wide range of applications. We have many clients that have realised the huge savings in time, money and maintenance representing significantly better returns on their investment over traditional materials.

The following pages illustrate the wide variety of applications used by some of our Triple X clients. From challenging terrain, security, livestock containment through to badger, otter, poultry and boar fencing. In all these examples the client was faced with a specific problem and Triple X has proved to be the best long-lasting solution.

 Watch case study videos online
www.mcveighparker.com/blog/category/case-studies/

NATIONAL TRUST 'OUT WITH THE OLD'

XHT8-80-22



SURREY 



The National Trust needed to replace their deteriorating original metal fence which had stood for over 100 years. Aesthetic appearance, time and value for money were all considerations. The terrain was extremely challenging. The project required a product that would not only stand up to stock pressure but would be easier to transport and erect on site. Triple X fencing system was chosen as it solved all these problems.

Intermediate posts: 1.8m 11 clip Clipex® Standard posts

Intermediate post centres: 4m centres for woodland perimeter and 3m for dividing paddocks

Beefy intermediates: Used at slight changes in direction

Strainer type: Triple X all steel diagonal strainer

Wire type: X Fence premium long-life lamb friendly wire netting XHT8-80-22, 2.0mm high tensile heavily galvanised barbed wire

Tools used: Hand-held petrol post driver, cutters

CL2715	1.8m 11 clip Clipex® Standard posts
CL2720	2.0m 11 clip Clipex® Beefy posts
KCPX10	Triple X strainer 2.4m, ends c/w struts
KCPX20	Triple X strainer 2.4m, two way/corner c/w struts
F2415	XHT8-80-22 X Fence, 100m
F2014	2.0mm high tensile barbed wire, 200m

“ I initially rejected Clipex® due to its light appearance and what I thought would be fiddly installation. I have been proved wrong. I have been very impressed how quickly it can be erected and combining X Fence and the Triple X strainers makes for a very strong fence. I certainly think it's going to be the future of fencing. ”

-Nathan of NB Fencing Services 

LIVESTOCK TRIPLE X

XHT8-80-22



Kent and East Sussex Railway needed to replace existing trackside fencing. The contractors were limited to working within the land owned by the railway. This meant all materials had to be delivered by train with no access for tractors. Everything then had to be lifted manually and erected over a four mile stretch.

Intermediate posts: 1.8m 11 clip Clipex® Standard posts

Intermediate post centres: 4.5m centres

Strainer type: Triple X diagonal all steel strainer

Wire type: XHT8-80-22 X Fence, high tensile barbed wire, baseline 2.5mm high tensile galvanised wire

“ We were persuaded initially by MP to do a trial run, and were very impressed. The Triple X system has saved us money and increased efficiency. We have gone on to supply and erect for customers such as The Big Cat Foundation, Network Rail, Kent and East Sussex Steam Railway and many farmers in the area. It certainly seems to be the way forward with customers now requesting it. ”

- P.M.Tassell Fencing Contractors

DORSET

Extremely hilly terrain was the problem facing this fencing contractor. We recommended the Triple X fencing system and initially assisted in the installation. Despite the contractor's reservations he was very impressed with the end result.

Intermediate posts: 1.8m 11 clip Clipex® Standard posts

Intermediate post centres: 4.5m centres

Beefy intermediates: Every 5th post

Strainer type: Triple X diagonal all steel strainers

Wire type: XHT8-80-22 X Fence, 2.0mm HT barbed, 2.5 mm baseline

“ Easy to erect, fast and effective - the way forward. ”

- R.Milne, Fencing contractor



KENT

NATIONAL TRUST CISSBURY HILL

XHT8-80-22



SUSSEX

Cissbury Ring is the most historic hill on the South Downs, set high up on a chalk promontory. The National Trust required a fence creating minimal ground disturbance due to the historic importance of the site and one that would not be detrimental to the landscape. It also needed to last longer than current timber fences. Triple X was the preferred choice.

Intermediate posts: 1.8m 11 clip Clipex® Standard posts

Intermediate post centres: 4.5m centres

Strainer type: Triple X all steel strainer every 150m

Wire type: XHT8-80-22 X Fence, high tensile 2.00mm barbed wire, baseline 2.5mm high tensile galvanised wire

“ We were worried about the initial shininess of the new posts but now the fence is up the small profile makes them almost invisible and they have faded over time. We used a post driver on the straining post where we could and used a manual post driver for the rest. We had to use the existing post holes because of the monument status. ”

- Mr Oliver, Head Ranger

SCOTLAND

Replacement roadside stock fence in Scotland. The Triple X system was the fence of choice for the landowner.

Intermediate posts: 1.8m 11 clip Clipex® Standard posts

Intermediate post centres: 4.5m centres

Beefy intermediates: Every 5th post

Strainer type: Triple X diagonal end all steel strainers every 100m

Wire type: XHT8-80-22 X Fence, 2.0mm high tensile electric top line Clipex® and permanent end egg insulators



LIVESTOCK EXTREME TRIPLE X

XHT8-80-22



LIVESTOCK ELECTRIC TRIPLE X

XHT8-80-22



RAILWAY/CATTLE TRIPLE X

XHT11-122-15



Network Rail required a secure, long-lasting and low maintenance track-side fence that would prevent livestock incursion.

The Triple X fencing system ticked all the boxes; long-life, easy to transport to site, simple to install, strength where it matters, alternative options to cope with various terrain, reduced health and safety requirements due to the lighter nature of the products, fewer staff and less heavy machinery required. Also a real return on investment.

The Triple X fencing system was chosen and a fence pattern designed by Network Rail.

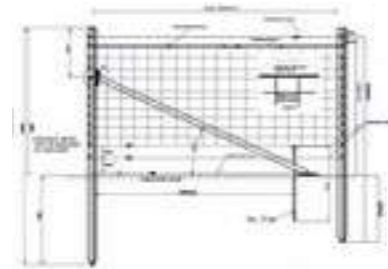

- CLR2710** 2.0m 13 clip Clipex® Cattle/Railway Standard post
- CLR2720** 2.1m 13 clip Clipex® Cattle/Railway Beefy post
- KCPX10** Triple X strainer diagonal 2.4m, ends c/w struts
- KCPX20** Triple X strainer diagonal 2.4m, two way/corner c/w struts
- F2405** XHT11-122-15 X Fence, 100m (XHT11-122-7.5 for horse paddocks)
- F2014** 2.0mm high tensile barbed wire, 200m
- F2140** 2.5mm high tensile baseline
- A1520** Medium, Gripple Plus Wire Joiner
- A1525** Gripple T-clips
- Clipex® Caps (for use in horse paddocks)

Network Rail have also designed a rapid response kit to deal with emergency repairs quickly.

KRRK



NATIONWIDE

POULTRY FENCING TRIPLE X

XHT26-240-5



SECURITY TRIPLE X

XHT19-180-5



The largest free-range poultry producer in Southern England was looking to reduce its annual fence maintenance costs and create a secure fence for its farms. Manager Mr. G. Fuller used his past experience to design an X Fence netting pattern that he was confident would exclude predators. The Triple X system was chosen coupled with special cranks.

Intermediate posts: 3.0m 14 clip Clipex® Deer Standard posts

Clipex® cranked arms & Clipex® insulators

Intermediate post centres: 5m centres

Strainer type: Triple X diagonal all steel strainers

Wire type: X Fence XHT26-240-5 buried, 2.5mm high tensile support lines, Clipex® insulators

“We erected over 10.5km of fencing 1.95m above ground and 450mm buried, including an apron fold above. Working closely with McVeigh Parker on a fence design to future-proof our operations and give us a real R.O.I. We don't have to walk the fence line frequently checking for predator incursion. This fence offers us complete peace of mind, security and durability.”

-G.Fuller, Poultry Manager

SURREY

Security X Fence XHT19-180-5 clipped to high tensile line wires. Using Standard and Beefy Clipex® Deer posts and Triple X strainers. All products had to be carried and manually installed on site.

Intermediate posts: 3.0m 14 clip Clipex® Deer Standard posts

Intermediate post centres: 5m centres

Strainer type: Triple X diagonal all steel strainers

Wire type: Security X Fence XHT19-180-5, 2.5mm HT support lines

Tools used: Manual petrol driver

Use: Person exclusion



SOLAR FARM TRIPLE X

XLHT13-190-15



VINEYARD PROTECTION TRIPLE X

XLHT13-190-15



GLOUCESTERSHIRE

The client's request was to provide a secure fence for a newly developed solar farm. The fence specification had to have a desired life in excess of 25 years. The chosen design involved the cost effective long-life X Fence light deer wire netting with easy to install Clipex® deer posts and one line of high tensile barbed wire. All products were standard and delivered within a week of the order.

Intermediate posts: 3.0m 14 clip Clipex® Deer Standard posts

Intermediate post centres: 3.5m centres

Strainer type: Triple X diagonal all steel strainer

Wire type: X Fence premium long-life lightweight wire netting, XLHT13-190-15, 2.0mm high tensile barbed wire

Tools used: Tractor, knocker, Grippl Plus Wire Joiners, cutters, Clipex® drive sleeve

Use: Deer/person exclusion

CL2725	3.0m 14 clip Clipex® Deer Standard Post
KCPX30	3.0m Triple X strainer ends c/w struts
KCPX40	3.0m Triple X strainer corner/two way c/w struts
F2441	XLHT13-190-15 X Fence light deer netting, 100m
F2014	2.0mm high tensile barbed wire, 200m
CL2790	Clipex® drive sleeve, standard
A1520	Medium, Grippl Plus Wire Joiner
A1525	Grippl T-clips

Vineyard protection fence was required for a recently planted vineyard to protect vulnerable saplings from deer predation. Land owner and contractor erected.

Use: Deer exclusion

SUSSEX



BALCASKIE ESTATE TRIPLE X

XHT8-80-22



FIFE - SCOTLAND

The Balcaskie Estate is in the East Neuk of Fife, source of some of the best ingredients in Scotland, with its rich fertile volcanic soil, bounded on three sides by the sea. The severe weather conditions of the coastal location meant serious consideration had to be given to the type of fencing chosen.

Jim McLure & Poul Thomassen are the two men with the responsibility of maintaining the Balcaskie Estate. They have both been very busy throughout the exceptionally difficult Covid pandemic, and together with all the usual demanding work of the estate, they have managed to install over 20,000m of fencing, choosing the multi award winning Triple X fencing system.

“We would highly recommend it. The cost of Triple X fencing is no more expensive than timber when you take your time into it, and you are making a saving on a fence that will last for generations.”

-Jim McLure, Balcaskie, Farm & Estate Maintenance

Intermediate posts: 1.8m 11 clip Clipex® Standard posts

Intermediate post centres: 4m centres

Beefy intermediates: 2.0m Beefy posts 11 clip (Beefy every 4th post)

Strainer type: Triple X all steel diagonal end and corner/two way strainer

Wire type: X Fence XHT8-80-22 lamb friendly netting, 2.5mm High tensile electric top wire

Tools used: Tractor knocker in the summer months, quad and hand-held petrol post driver in the winter



PORT LYMPNE TRIPLE X

XHT13-190-22

HYTHE 

We got involved in an urgent project erecting a roan antelope fence before the re-opening of Port Lympne Wild Animal Reserve. The project consisted of several challenges; along with the very short time frame, there was a need to have a fence strong enough to contain both roan antelope and camels, plus the aesthetics had to be right for the public to view the animals.

Simon, the reserve director, was looking for a long life fence. Having previously trialled Clipex® posts for electric fencing, he was concerned that the taller deer fencing components used in the Triple X fencing system would be too visible from the visitor lodges.

Contractor P.M.Tassell Fencing was able to complete the job in the short time frame available, and McVeigh Parker was confident we could offer a product that would satisfy the demands of the reserve. All the posts were painted with special adhesive black paint which ensured they would blend into the landscape.

There is occasional concern about the appearance of galvanised posts in sensitive areas. With the narrow profile of the post, at least a third that of timber posts, and the alu/zinc coated wire which darkens over time, we are now confident we have the solution for most applications.

Intermediate posts: 3.0m 14 clip Clipex® Deer Beefy posts

Intermediate post centres: 4.5m centres

Strainer type: Triple X Box all steel strainers

Wire type: X Fence XHT13-190-22

Extras: Gripple T clips at the ends, crimp joins, Deer gates



Bespoke Case Studies

Our belief that the Triple X system is the future of fencing is reinforced by the versatility it offers our customers. The following case studies show how bespoke versions of the system can be adapted to suit almost every project. McVeigh Parker customers are able to use individual elements of Triple X in combination with more traditional fencing materials if the job demands it. The following examples show fencing systems using timber strainers in conjunction with X Fence and Clipex® posts and others using hinge-jointed wire with Triple X strainers and Clipex® posts.

POULTRY FENCING

LHT13-190-7.5

A free range poultry unit required protection from fox predation. High tensile hinge jointed poultry netting was chosen coupled with Clipex® Deer and Pasture posts to form a protective enclosure.

Intermediate posts: 3.0m 14 clip Clipex® Deer posts, 1.5m 4 clip Pasture posts

Intermediate post centres: 6.0m centres

Beefy intermediates: 3.0m 14 clip Clipex® Beefy Deer posts

Strainer type: Triple X diagonal all steel strainers

Wire type: LHT13-190-7.5 hinge jointed, 2.0mm high tensile, electric lines plus separate three line external perimeter electric fence

Use: Predator exclusion / poultry containment

“I've used Clipex® before for my livestock because I was fed up of just constantly re-doing timber fencing. For our new venture of 16,000 laying hens... Clipex® was the only way forward. Far less maintenance and so easy to erect.”

-M.Brown, Free range chicken farmer



SOMERSET



MY DOG FIELD X KNOT FENCE

XLHT13-190-7.5



LANCASHIRE

Innovative new business My Dog Field occupies a picturesque three acre plot of moorland situated between Manchester and Huddersfield. They provide customers with a secure field for hire with other dog owners, or to have sole use of. This allows them to let their dogs run free, in safety, and makes it easier to carry out training without the worry of their pet escaping or being attacked by other dogs.

In order to justify the investment it was vital that the area was secured safely, reliably and with a product that will last a long time. The terrain is steep, rocky and there is no access for heavy machinery. My Dog Field chose X Fence wire, Clipex® posts and creosoted strainers as the perfect solution.

After thoroughly researching all the options the owner Charlotte, chose McVeigh Parker's industry-leading products. Alongside reliable security, an important consideration is value for money – investing in fencing guaranteed to last will save money in the long term.

This type of simple fencing system has since been used on numerous similar projects throughout the UK.

Intermediate posts: 3.0m 14 clip Clipex® Deer Standard posts

Intermediate post centres: 4m centres

Strainer type: Creosoted strainers

Wire type: X Fence XLHT13-190-7.5, lightweight boar/dog

Tools used: Hydraulic post driver, deer clamps and chains, Ezecrimp pliers and crimps



LIVESTOCK X KNOT FENCE

XHT8-80-22



HORSE FENCING X KNOT FENCE

XHT11-122-7.5

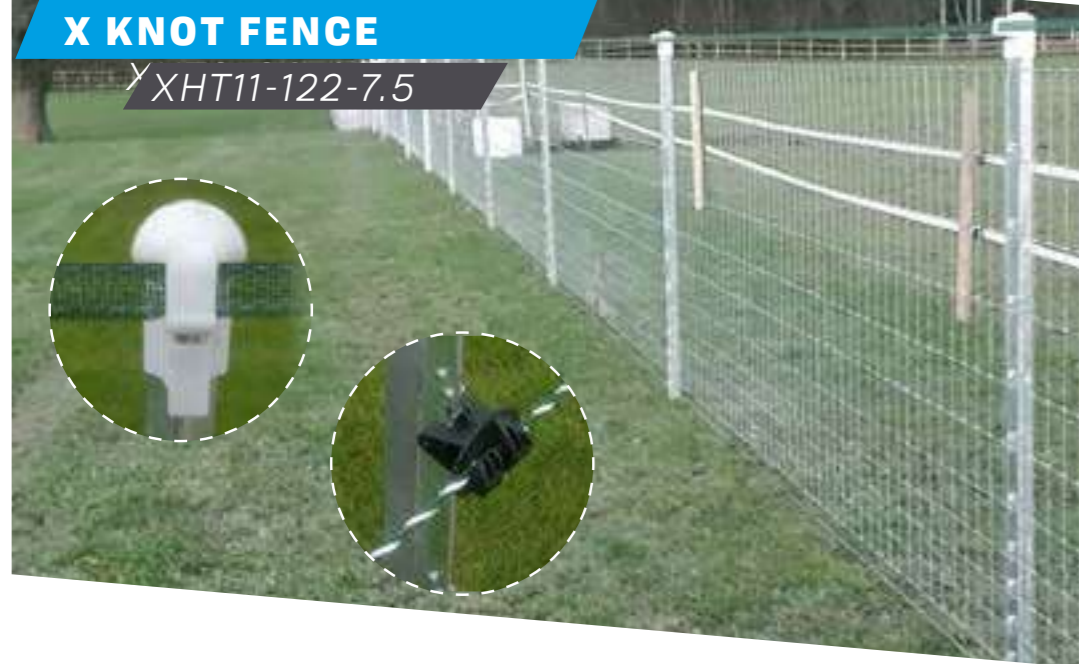

KENT



The Environment Agency needed a long-life fence capable of preventing livestock from breaching a flood defence bund. Once again McVeigh Parker provided the answer.

Beefy intermediates: 2.0m 11 clip Clipex® posts used throughout

Intermediate post centres: 2.0m centres

Strainer type: Pressure creosoted pine strainers

Wire type: X Fence stock wire netting XHT8-80-15, 2.0mm high tensile heavily galvanised barbed wire, 2.5mm galvanised baseline

Tools used: Tractor, knocker, cutters, Clipex® drive sleeve, stapler

SHROPSHIRE

The remit for this large horse rescue centre was to provide a fence that would reduce maintenance, prevent cribbing, last longer than current timber fencing, and contain the horses safely.

Triple X system using X Fence XHT11-122-7.5 horse netting with Clipex® caps and premium Diamond Brand green electric tape.

Intermediate posts: 2.0m 13 clip Clipex® Cattle/Railway Standard posts

Intermediate post centres: 3.5m

Beefy intermediates: Used every 6th post

Strainer type: Triple X diagonal all steel strainer

Wire type: Horse X Fence XHT11-122-7.5, Clipex® post cap insulators, end/corner reinforced tape insulators, 20mm green premium electric horse tape



Matt Smith and his wife Pip occupy 310 acres on the edge of Bodmin Moor, farming over 1,000 ewes & 250 breeding hinds equating to approximately 600 red deer at any one time.

“ We were looking for a long-lasting fence, when we came across McVeigh Parker and the steel post system. Aesthetically it was something I was unsure of at first, but like it or not, you can't deny it makes perfect business sense. I didn't want to fence this farm four times in my lifetime or leave it in a state of disrepair for the next generation.”

- Matt Smith



Watch video online

DEER FARM X FENCE STOCK FENCE

XHT13-190-15

CORNWALL



Well-known for his world record sheep shearing. McVeigh Parker customer and farmer Matt Smith needed a long-lasting fence to contain deer. Clipex® Beefys coupled with X Fence wire were his first choice and Matt then installed the fence himself whilst continuing to farm.

Beefy intermediates: 3.0m 14 clip Clipex® Deer Beefy posts used throughout

Intermediate post centres: 8m

Strainer type: Customer used reclaimed box beam crash barrier

Wire type: XHT13-190-15 X Fence deer netting

Tools used: Tractor and knocker, crimps, clamp bar and staples - two men

Use: Deer containment

“The speed you can put this fence up is phenomenal. Once you understand it. Two of us put up twelve thousand metres of deer fencing in under three months whilst continuing to farm and shear.

We wanted a long-lasting fence, there really was only one choice, quality NZ wire with Clipex® steel posts. It proved to be time and cost effective to erect, a great system, even if half of it is from Oz! ”

-NZ born, M.Smith

TREE PLANTATION DEER PROTECTION

XLHT13-190-15

BERKSHIRE

One of the largest Christmas tree growers in the UK needed protection from deer and rabbit on their new plantation. Light X Fence and hexagonal rabbit netting erected on Clipex® deer posts was the chosen combination that provided the best option.

Intermediate posts: 3.0m 14 clip Clipex® Deer Standard posts

Intermediate post centres: Every 4.5m

Beefy intermediates: Beefy 3.0m 14 clip bespoke Clipex® posts were used every 4th post to strengthen the fence

Strainer type: Triple X diagonal all steel strainers

Wire type: XLHT13-190-15 X Fence light deer netting, 1050mm super 6 heavy gauge hexagonal wire netting at the base

Use: Deer and rabbit exclusion

RABBIT NETTING HEX WIRE NETTING

ON HT LINE WIRE

KENT

The landowner wanted a rabbit fence that would last for many years. In the past he had opted for heavy gauge Super 6 hexagonal rabbit wire netting but wanted longer life posts to support it. Clipex® Standards with two high tensile support wires and two rows of barbed were the products he chose.

Intermediate posts: 1.8m 11 clip Clipex® Standard posts

Intermediate post centres: 5m - 6m

Strainer type: Chestnut strainer ends

Wire type: 18g rabbit netting using high tensile line wire, 2.0mm galvanised barbed wire

Use: Rabbit exclusion



RED DEER FARM X FENCE DEER

XHT17-190-15

A challenging brief to contain red deer around a client's estate, as well as exclude smaller breeds such as Muntjac. The fence had to have a desired life in excess of 25 years. The chosen design involved the long-life X Fence wire netting with long-life Clipex® steel posts and two lines of electric wire.

Intermediate posts: Bespoke design 3.0m 18 clip Clipex® Standard posts

Intermediate post centres: 4m centres (special design, MOQ 2000)

Beefy intermediates: Bespoke design 3.0m 18 clip Clipex® Beefy posts were used every 4th post to strengthen the fence

Strainer type: Customer used reclaimed telegraph poles

Wire type: XHT17-190-15 X Fence premium long wire netting, 2.0mm high tensile heavily galvanised electric lines

Tools used: Tractor and knocker, crimps, clamp bar and staples - two men

Special	3.0m 18 clip Clipex® bespoke Standard posts 3.0m 18 clip Clipex® bespoke Beefy posts
F2444	XHT17-190-15 X Fence, 100m
F2104	2.0mm high tensile plain galvanised wire
CL2790	Clipex® drive sleeve, standard
CL2793	Clipex® drive sleeve, Beefy
EF2055	Clipex® insulators
EF2120	Offset wire insulator, 30cm

Use: Deer containment

NORFOLK



SEMI-PERMANENT ELECTRIC FENCE DESIGN

HT LINE WIRE

BERKSHIRE



Realising pasture potential - UK farmers are looking to optimise their pasture land, Clipex® posts have the answer.

The Clipex® Pasture post system has been designed to facilitate the growing market for managed intensive rotational grazing. Resting grazed land allows the vegetation to renew, rebuild shoots and deepen the root systems, resulting in a long-term increase in biomass.

High quality products were combined to provide a simple long-life electric fence solution. Pasture posts come in an Eco and Beefy profile, neither have anti-lift plates allowing them to be relocated easily. Clipex® insulators are also easily retro-fitted to these four clip posts. The clips are suitably spaced to allow you to install a one, two, three or four line system subject to your livestock type.

The posts can be used to create a permanent ring fence with semi-permanent dividing paddocks allowing for rotational grazing or combined with other pasture control systems providing a stronger, longer lasting fence. Coupled with our range of Gallagher energisers and fittings this is a simple fencing system that allows easy management of stock.

Pasture posts are also ideal for temporary rabbit fencing or simple demarcation line wire fence.

Intermediate posts: 1.5m 4 clip Clipex® Eco and Beefy Pasture posts

Intermediate post centres: 6m -10m centres

Beefy intermediates: At slight change of direction/ends

Wire type: High tensile line wire, Clipex® insulator

“Clipex® has enabled us to permanently fence areas we were unable to with traditional fencing. We have now got a ring fence around the entire farm, something we had not tackled in the past due to the limited access for machinery on the steep downland we graze.”

- S.Cath at West Woodhay



Line Wire Systems

Clipex® heavy hot dip galvanised posts have pre-set clips to match various wire patterns however, this doesn't restrict their use. Clipex® posts are quick and easy to install, provide a strong long-lasting fence and can be used on various different projects using a simple line wire system. Strain three or four support wires and clip them into your chosen spacings on the posts, then your choice of wire netting can easily be clipped to the support wires. This type of fencing system is especially useful when installing a fence line that needs to be trenched in or has a closer mesh pattern.



“One Long-Life Post
- Many Options”



X FENCE SPECIAL

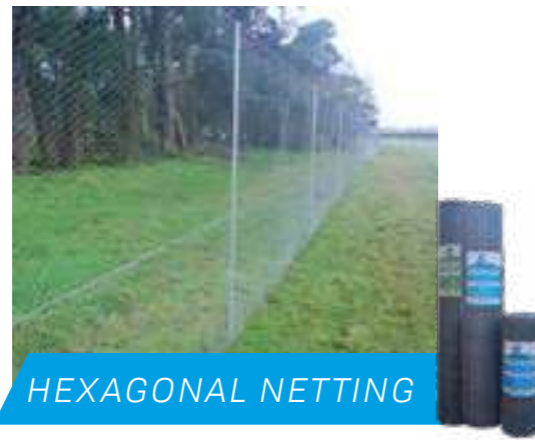

HEXAGONAL NETTING



CHAIN LINK



WELDED MESH

Line Wire Alternatives



SEMI-PERMANENT ELECTRIC FENCE DESIGN

HT LINE WIRE



Wallow Artisan Charcuterie, Guernsey, opted for Clipex® for their new business venture, breeding pedigree free range pigs to create some of the finest locally produced charcuterie.

Intermediate posts: 1.5m 4 clip Clipex® Pasture posts

Intermediate post centres: 6m centres

Wire type: High tensile line wire

Strainer type: UC4 timber

“We had tried timber posts which tended to be difficult to install and failed prematurely. Clipex® allowed us the time to build our business rather than waste time fencing. It's quick and easy to erect, and it can be moved to suit the rotation required with our paddock control.”

- M.Terry



FLOODPLAIN FENCE DESIGN

HT LINE WIRE



The Till river project involved installing 850m of new fence. The site was on the flood plain so traditional fencing could not be used. Due to the speed and ease that it could be erected the perfect solution was Triple X using a single wire system instead of netting. Clipex® steel posts, insulators and three strands of electric wire were quickly installed. The fence was designed to protect the river bank from further livestock damage, allowing the ground to stabilise and vegetation to re-grow. This enabled the landowner to plan a short cycle rotational grazing system, maximising the land value.

Fixings: Clipex® insulators, ratchet winders

“The Triple X system allowed quick and easy erection of new fence lines using wire, stock net or electric lines. Simply clipped onto steel posts. TRRS has worked closely with the landowner and McVeigh Parker to develop a bespoke specification for a floodplain site.”

- Project Officer for The Tweed Forum



LINE WIRE FLOOD FENCE

HT LINE WIRE



After years of having to replace timber posts, clearing debris off netting, tensioning and repairing the fence after flood damage, the landowner needed to look at alternatives. The solution he found was a simple 8-line fence with ratchet tensioners at either end. This allows the tension to be taken off, so the lower line wires can be simply moved up, out of the way of flood damage. Clipex® insulators can be attached easily to the posts and the fence electrified.

Intermediate posts: 1.8m 11 clip Clipex® Standard posts

Fixings: Clipex® insulators, ratchet winders

“After a trial with Clipex®, we now use a line wire system on a flood plain within the estate and Deer posts for a large pheasant pen in our woodland. Ease of use, lightweight and speedy installation along with the 30 year guarantee make this our first choice for fencing.”

- J. Freestone at Overbury



BESPOKE HOP POSTS DESIGN

HOP NETTING

Clipex® bespoke hop posts have been designed for the hop market. The smaller profile enables easier harvesting whilst the strength and galvanised finish give a longer maintenance free life. The post was designed with a self-locking top clip to prevent the harvester hooking out the top wire when picking the hops. Plus a ground base clip to take the base wire so the synthetic netting can be tensioned between the two.

Beefy intermediates: Bespoke 4.5m 2 Clip Beefy posts

Beefy post centres: 7m centres

Wire type: Synthetic netting

“ My reason for choosing Clipex® all steel posts was quite simply the life expectancy of over 30 years. An initial investment but thereafter maintenance is greatly reduced. The smaller profile made installation easier, we did not need heavy machinery, so ground compaction was reduced. The larger Beefy profile has proved very successful, so much so that I plan on replacing my old chestnut poles with Clipex®. ”

- R. Humphreys, Kent Hop Grower



BESPOKE CONTRACTOR DESIGN

HT LINE & BARBED

This customer wanted a cost-effective livestock fence. He designed his own posts to suit line wire and netting. *Minimum bespoke order 2,000 posts.*

Intermediate posts: 1.8m 11 clip Clipex® Standard posts

Strainer type: Creosoted strainers

Wire type: 2.5mm high tensile line wire, 2.0mm high tensile barbed wire

Dropper Line Wire Systems



Clipex® posts coupled with droppers and single strand wire can create a very cost-effective strong and versatile fence.

Intermediate posts can be spaced further apart saving on overall material and labour costs. Droppers can be easily retro-fitted. Combined with tension springs and ratchet winders, this single strand fence can cope with all climatic changes whilst retaining its tension. Various dropper designs available in steel, timber, wire, electric and plastic.



Photos courtesy of Morgan fencing

Adaptable to Your Requirements

Clipex® is unrivalled in its versatility. McVeigh Parker offer five different patterns in five different lengths and it is available in 2.5mm, 3.0mm and 3.5mm thick gauge. Extensions can be added at its base or top to extend it by 510mm. This makes Clipex® very adaptable, many problems can be solved with Clipex®. The Clipex® self-locking clip sits inside the post preventing any damage when it's being driven in.

Installing could not be simpler...

Manually

- Post bumper designed to suit both Standard and Beefy intermediates.
- Post hole diggers are ideal to manually install strainers. (Not essential but strainers can be concreted in)

Petrol post driver

- The perfect partner for the Triple X all steel system, supplied with specific adaptors to suit Clipex® Standard and Beefy posts.
- 1720 percussions per minute ensure a steady and direct hit every time, enabling Clipex® posts to be installed into some of the most difficult ground conditions.



Did you know?

- The 4 stroke petrol post driver has a high impact hammer action of 1720 beats per minute and only weighs 15.3kg, making it ideal for one man operation, even in the most challenging terrain

SEE PAGE: 49 for full specification



Mechanical attachments

- There are various hydraulic and pneumatic vibrating head attachments on the market that can be attached to any mini excavator. The simple percussion hits make them ideal for Triple X fencing installations.

Tractor and track mounted post drivers

- These large bits of kit are ideal for strainers, dispensing wire and transporting product. If using on intermediate posts we recommend a slow percussion rate.

Installation



Step 1
Secure your corner/end strainer



Step 2
Tie off wire netting both ends and tension to middle until upright and taut



Step 3
Place Clipex® posts between vertical wires at even spacings then drive in



Step 4
Push the wire into the slot putting pressure on the keeper



Step 5
Push the wire down, the keeper will automatically close



Step 6
Finally tension fence to allow tension curves to reduce by 50%, Job done!

Wire Joining

Traditional



Crimps



Gripple products



Strainer tie offs

Traditional



Crimps

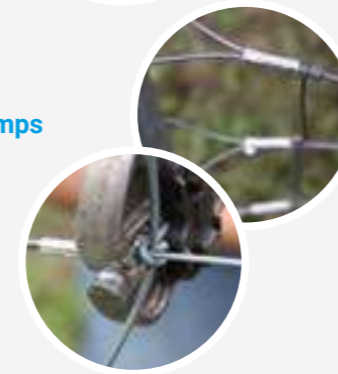

Gripple products

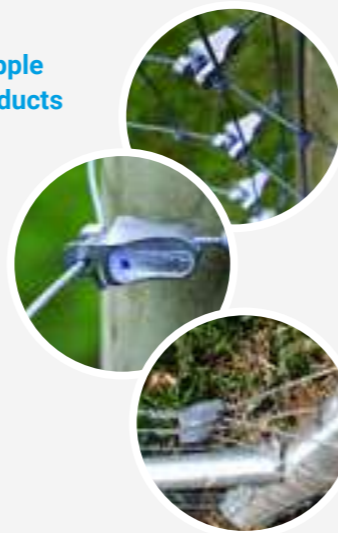

Product Guide



Clipex® Intermediate Posts	Wire	Length	Gauge	Code
Clipex Pasture post 4 Clip	Single wires	1.5m	2.50mm	CL2705
Clipex Pasture post 4 Clip, Beefy	Single wires	1.5m	3.50mm	CL2708
Clipex Eco post 10 Clip	Hinge joint	1.8m	2.50mm	CL2710
Clipex Standard post 11 clip	X Fence	1.8m	3.00mm	CL2715
Clipex Standard 'Rock' post 11 clip	X Fence	1.5m	3.00mm	CL2716
Clipex Beefy post 11 clip	X Fence	2.0m	3.50mm	CL2720
Clipex Railway/Cattle Standard post 13 clip	X Fence	2.0m	3.00mm	CLR2710
Clipex Railway/Cattle Beefy post 13 clip	X Fence	2.1m	3.50mm	CLR2720
Clipex Deer Standard 14 clip	X Fence	3.0m	3.00mm	CL2725
Clipex Deer Beefy 14 clip	X Fence	3.0m	3.50mm	CL2730
Clipex Beefy strut bracket	-	-	-	CL2765
Clipex 51cm Standard offset 3 clip	-	-	-	CL2766
Clipex 51cm Beefy offset 3 clip	-	-	-	CL2767
Clipex Standard 4 bolt ext bracket	-	-	-	CL2768
Clipex Beefy 4 bolt ext bracket	-	-	-	CL2769

EMERGENCY FENCE REPAIR

Did you know?

- Clipex® posts can be used as an emergency repair or to shore up existing post failures

"Always have some posts in stock with Gripple wire joiners for those late night emergencies"



Triple X Strainers	Length	Code
Triple X Diagonal End Strainer Stock c/w 1 x Triple X strut stock assembly	2.4m	KCPX10
Triple X Diagonal Corner/Two Strainer Stock c/w 2 x Triple X strut stock assemblies	2.4m	KCPX20
Triple X Box End Strainer Stock c/w 1 x strut & claw brackets	2.4m	KCPX18
Triple X Box Corner/Two Strainer Stock c/w 2 x struts & claw brackets	2.4m	KCPX25
Beefy End Economy Strainer Stock c/w Beefy 2.0m, 2.4m SFS GPAK3, pin & plate, strut bracket	2.0m	KCPX15
Triple X Diagonal End Strainers Deer c/w 1 x Triple X strut deer assembly	3.3m	KCPX30
Triple X Diag Corner/Two way Strainers Deer c/w 2 x Triple X strut deer assemblies	3.3m	KCPX40
Triple X Box End Strainers Deer c/w 1 x strut & claw brackets	3.3m	KCPX35
Triple X Box Corner/Two way Strainers Deer c/w 2 x struts & claw brackets	3.3m	KCPX45



Accessories & Tools

Clipex® Insulator



- Strong and durable UV protected plastic
- Suitable for wire, poly wire, electric rope
- Quick and easy to install, can also be retro-fitted

Clipex® Post Caps



- Smooth rounded top for safer stock handling
- Quick and easy to install, can also be retro-fitted
- Inbuilt offset insulator to take rope, wire or tape up to 20mm

Size	Code
Standard	EF2058
Beefy	EF2059

Clipex® Bolt on Offset Insulator

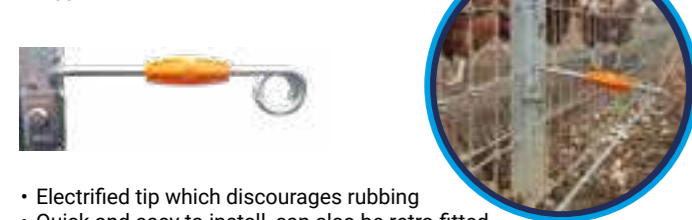

- Electrified tip which discourages rubbing
- Quick and easy to install, can also be retro-fitted
- Unique patented lockset design for solid attachment

Clipex® Extension Brackets



- 4 bolt extension bracket
- Extend the height or depth of your post
- Adaptable extension can be retro-fitted

Size	Code
Standard	CL2768
Beefy	CL2769

Clipex® Vertical Extensions

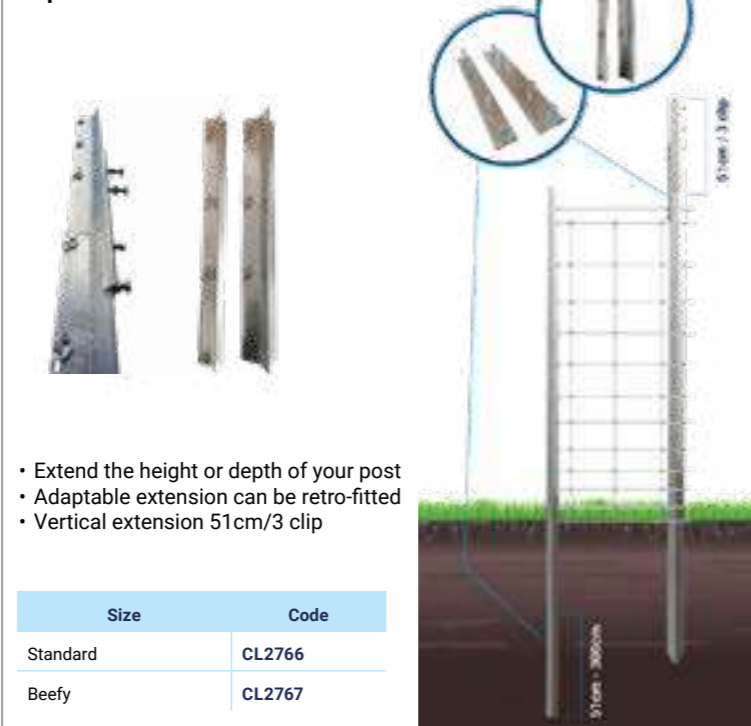

- Extend the height or depth of your post
- Adaptable extension can be retro-fitted
- Vertical extension 51cm/3 clip

Size	Code
Standard	CL2766
Beefy	CL2767

Post Driver Sleeve



- Protects the top of Clipex® posts
- Only use with manual or hydraulic drivers
- Not suitable for use with a petrol post driver

Size	Code
Standard	CL2790
Beefy	CL2793

Clipex® Standard Post Rammer



- Clipex® and timber compatible
- Up to 70mm diameter
- 8kg weight
- 80cm length

Cranked Extensions



Corner and end cranks



We have designed various cranked arm options to take apron fold netting, electric lines or barbed wire.

For more details please contact us with your requirements.

Heavy Duty End Strain insulator



- Suitable for fitting cord or wire to wooden posts
- Super strong - made from polycarbonate
- 10-year product warranty

Cliplock Wire Strainers



- NZ made Cliplock wire strainer
- Smooth clicking action
- Easily operated upside down

Ratchet Handle



- Spring loaded ratchet pin allows easy repeat operation
- Universal handle design allows side tensioning for awkward areas
- Corrosion Protected by gold zinc passivation coating

Tension Springs



- Can be used at end or in-line
- Maximum tension strength 200kg
- Suitable for up to 2.5mm high tensile wire
- Allows wire to expand and contract in climate changes whilst keeping tension

Insulated Clip Strainer



- Specifically designed for electric fencing
- Maximises the spark distance
- Can be threaded directly onto fence wire

Strainer Clamp

Size	Code
Stock fence	A2220
Horse fence	A2225
Deer fence	A2230



- Used to strain wire stock netting
- Available in three heights to suit different fences
- Save time and money reducing labour costs

The Gripper



- Single wire gripper
- Spring loaded so will not slip or drop wire
- Suitable for 1.0 - 4.0mm plain wire

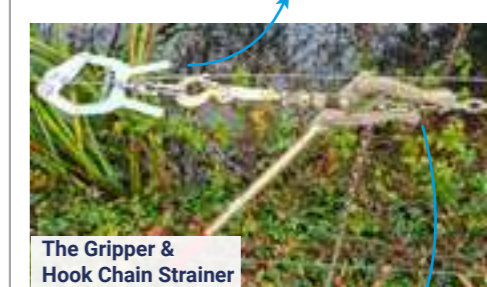

Hook Chain Strainer



- 6m chain
- Use with additional strainer clamps or grippers
- Compatible with any wire size and type

Winch Hoist Strainer



- Non-slip replaceable teeth
- Deliver full load transfer
- Wire strainer, 500kg hoist

StraineX kit consist of - 1 x lever hoist, 2 x Grippers, (tension gauges optional add on, spring or digital) & canvas holdall

Spring Wire Gauge

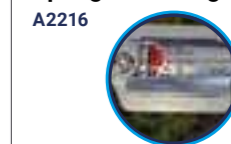

Digital Tension Gauge



Spring Grip Strainer



Carry one tool for straining both plain wire and net fencing with fast and easy to use or remove clip on parts

- Spring loaded grippers
- High tensile walker main body c/w snap hook
- 3 metre stainless steel chain c/w snap hook
- Chain post swivel
- Pawl mounted arm springs
- High tensile steel construction

Wreman Walker classic - 1 x Walker, 3m chain, 2 x Grippers, (tension gauges optional add on, spring or digital)

Wire Grab Chain Strainer



- 'Monkey' wire chain strainer
- Includes 2 x smooth grip jaws
- Compatible with plain or barbed wire 1.6 - 5.0mm

Ezepull
A2247



- Ultracrimp 5 in 1 fencing tool
- Ideal for staple pulling, wire crimping, wire cutting, wire stripping and wire joining

Strainrite Crimps



- Crimps are designed to provide a non-abrasive permanent joint
- Easiest and most effective means of joining wire
- Available in five different sizes

Shop full range online

Collapsible Spinning Jenny

A2201



- Simplest way to uncoil high tensile steel wire without tangling or jamming
- Adjusts to most wire coil sizes
- Folds up for easy carrying

Gripple Tensioning tool

A1510



- Tension wire up to 400kg
- Works on all Gripples up to 6mm
- In-built torque gauge improves life of the wire

Gripple T-Clips



- Fast and easy way to tie-off wire
- Neat professional finish
- Ideal for awkward tight spaces

Knipex Cutters

A2043



- Suitable for soft and hard wire up to 5.2mm
- Recess cutting edge
- Cuts spring steel up to 3.6mm

Wire Twister

A1800



- Simple tool for making neat spiral wraps
- Left or right handed twisting
- Length: 78mm

Gripple Contractor Tool

A1518



- Heavy duty tensioning tool designed for daily use
- Works on all Gripples' products
- Inbuilt torque gauge improves life of the wire

Gripple Wire Joiners

	Size	Code
	Small	A1512
	Medium	A1520
	Large	A1535
	Jumbo	A1540

- Join and tension in one
- High load holding
- Save time installing and repairing fence lines

Maun Side Cutter Parallel Pliers

A2020



- Heavy-duty side-cutting pliers
- Parallel jaws for use cutting and bending high tensile wire and up to 6mm mild steel wire

Netting Pliers

KNP1



- Spring loaded cartridge
- Cartridge capacity 50 pre-formed clips
- Hog ring diameter 5-11mm

RP22 Netting Gun & Clip

KNP2



- Spring loaded cartridge
- Cartridge capacity 50 pre-formed clips
- Triangular ring diameter 6-8mm

Petrol Hand Held Post Driver

CL2795



- Designed to knock any size stake, peg or post into the ground, up to a 100mm dia (subject to soil conditions)

Triple X FAQs

1. How do Clipex® posts compare against creosoted, kiln dried, redwood timber?

A: Lighter to handle, no carcinogenic leaching, easier to drive in, easier to clip wire in, no stapling required, easier to transport. On price marginally more, however 50% lifetime savings are achievable. Lower carbon footprint over the lifetime of the fence. Fully recyclable.

2. Are Clipex® posts permanent?

A: Yes, they have been re-designed with anti-lift plates for the European market, making them virtually impossible to remove by hand. Clipex® galvanised coating and high tensile steel will provide a life in excess of 30 years. We consider this to be permanent.

3. What post spacing is required?

A: This is subject to the wire used and livestock pressure. Mild hinge joint requires around 2.4 metres, high tensile hinge joint at 3.5m centres, X knot wire 4.0m to 6m centres, obviously, the latter will save time, money, materials and labour, and provide a stronger longer lasting fence.

4. Can it be removed/stolen easily?

A: No, the Beefy especially has a larger profile and additional length making it virtually impossible to remove without the aid of machinery. We have designed the product with an anti-lift plate, which not only aids erection when going over undulating ground, it acts as a strong deterrent to any thieves. If additional protection is required in high population areas a simple security plate (CL2770) can be added.

5. Can it be used for permanent electric fence or line wire?

A: Yes, all Clipex® posts can be used for line wire fences then simply converted to electric by adding the unique Clipex® snappy insulator or using the Clipex® electric post cap. We also manufacture a pasture post which doesn't have the anti-lift plate which makes it suitable for semi-permanent electric fencing for sheep, pigs or cattle. Any post can be used to create a line wire and dropper system.

6. Will Clipex® posts fit any wire netting?

A: We have a post to suit most hinge jointed 8/80 fences in either HT or mild, whatever the brand. (Please check when ordering as some manufacturers have slightly different mesh spacings). We also have posts designed to suit our X knot stiffstay netting which offers greater returns on investment.

7. Does the wire rub in the slot scratching the galvanised coating?

A: If the fence is kept taut this should not be an issue. If you have an adjoining fence line that is going to receive a lot of attention it is advisable to use an alu/zinc coated netting such as X Fence as this wire has a sacrificial coating should any wire get exposed.

8. Will the post just pop out of the ground especially when the ground is dry?

A: McVeigh Parker have improved the Australian design to suit the European environment, more clips have been added which means more wires are held in place, and importantly an anti-lift plate reduces the possibility of the post popping out or being easily removed. It increases the holding of the post, especially on undulating ground.

9. How do I protect my animals from harming themselves on the post?

A. The easy to install Clipex® electric post cap slots over the top of the post, an anti-lift clip prevents removal by livestock. It not only offers a smooth non-abrasive surface but also the facility to add an electric line within its construction.

For full FAQs please visit
www.mcveighparker.com/triple-x-faqs

Berkshire Branch

Southend, Bradfield,
Reading, RG7 6HA
Tel: 01189 744777
Email: berks@mcveighparker.co.uk

Cambridge Branch

Caxton Depot, Ermine Street,
Caxton, CB23 3PG
Tel: 01954 714110
Email: cambs@mcveighparker.co.uk

Devon Branch

Muxbeare Lane, Uffculme, Cullompton,
Devon, EX15 3BY
Tel: 01884 824486
Email: devon@mcveighparker.co.uk

Kent Branch

Thornden Farm, Lenham Road,
Headcorn, TN27 9LH
Tel: 01622 891095
Email: kent@mcveighparker.co.uk

Lancashire Branch

Park Lane Industrial Estate, Wigan Road,
Ashton-In-Makerfield, Wigan, WN4 0BZ
Tel: 01942 725523
Email: lancs@mcveighparker.co.uk

Scotland Branch

Market Road, Biggar,
Lanarkshire, ML12 6FX
Tel: 01899 221150
Email: scotland@mcveighparker.co.uk

Sussex Branch

Stane Street,
Billingshurst, RH14 9JR
Tel: 01403 784250
Email: sussex@mcveighparker.co.uk

Worcestershire Branch

Unit 16 Wilden Lane Ind. Estate,
Stourport on Severn, DY13 9JY
Tel: 01299 826111
Email: worcs@mcveighparker.co.uk



Go online now
www.mcveighparker.com
sales@mcveighparker.co.uk

McVeigh Parker

McVeigh Parker landscaping the future with Triple X all steel permanent fencing system.

The unique intermediate Clipex® posts are lightweight, exceptionally strong, very fast and easy to install. Combine with X Fence wire netting and Triple X all steel strainers to make a formidable fence.

The posts are much more durable than traditional timber posts, usually giving a three to four times longer service life, meaning the whole system is very cost-effective.

Huge savings in time, labour and machinery are possible.

WE DELIVER ON

Price

Quality

Service

Experience

Innovation

Key account manager and trade enquiries contact
trade@mcveighparker.co.uk

TRIPLE X
Spec sheet available
to download online





sales@mcveighparker.co.uk

www.mcveighparker.com

www.mcveighparker.com/triple-x-fencing

© McVeigh Parker reserve the right to change any specification and alter design without notice.
All specifications are correct at time of going to print. E&OE.

Version No.4 2023



[/McVeighParker](https://www.facebook.com/McVeighParker)



[@McVeigh_Parker](https://twitter.com/McVeigh_Parker)



[mcveigh_parker_est1979](https://www.instagram.com/mcveigh_parker_est1979)