

# Curve Sketching Assignment

Graph the following curves labelling ALL important points (including  $x$  and  $y$  intercepts, vertices or asymptotes where required.)

## PARABOLAE:-

Basic Curve  $y = x^2$

1.  $y = x^2 + 1$       2.  $y = x^2 - 2$       3.  $y = (x+2)^2$       4.  $y = 3x^2$       5.  $y = (x-1)^2 + 2$   
6.  $y = (3-x)^2$       7.  $y+1 = x^2$       8.  $y = -2x^2$       9.  $y = (x-1)(x+2)$       10.  $y = 4 - x^2$

## CUBICS:-

Basic Curve  $y = x^3$

11.  $y = x^3 - 2$       12.  $y = x^3 + 3$       13.  $y = (x+1)^3$       14.  $y = (x+2)(x-1)^2$       15.  $y = (x-2)^3$   
16.  $y = -x^3$       17.  $y = (x-1)(x+2)(x+3)$       18.  $y = x(x^2 - 1)$       19.  $y = x^2(x-3)$       20.  $y = (x-3)(x+2)^2$

## HYPERBOLAE:-

Basic Curve  $y = \frac{1}{x}$  or  $xy = 1$

21.  $y = \frac{2}{x}$       22.  $xy = 4$       23.  $y = \frac{1}{x} + 1$       24.  $y = \frac{1}{x} - 1$       25.  $y+1 = \frac{1}{x}$   
26.  $y-3 = \frac{1}{x}$       27.  $y = \frac{1}{x+1}$       28.  $y = \frac{1}{x-2}$       29.  $y-2 = \frac{1}{x-2}$       30.  $y = \frac{1}{x+2} - 3$

## EXPONENTIALS:-

Basic Curve  $y = a^x$

31.  $y = 2^x$       32.  $y = 5^x$       33.  $y = 3^x + 1$       34.  $y+1 = 4^x$       35.  $y = 2^{-x}$   
36.  $y = 3^{x+1}$       37.  $y = 1^x$       38.  $y = 3^{-x-1}$       39.  $y+2 = 4^{x+2}$       40.  $y-1 = 2^{1-x}$

## CIRCLES:-

Basic Curve  $x^2 + y^2 = r^2$        $[(x-h)^2 + (y-k)^2 = r^2]$  centre  $(h, k)$

41.  $x^2 + y^2 = 1$       42.  $y^2 = 4 - x^2$       43.  $x^2 + (y-1)^2 = 25$       44.  $(x+2)^2 + (y)^2 = 16$       45.  $y = \pm\sqrt{36-x^2}$   
46.  $y = \sqrt{4-x^2}$       47.  $x = \sqrt{25-y^2}$       48.  $(x-2)^2 + (y+1)^2 = 4$       49.  $x^2 = 1 - y^2$       50.  $(y-2)^2 + (x+3)^2 = 49$

# Curve Sketching Assignment

## PARABOLAE

1.

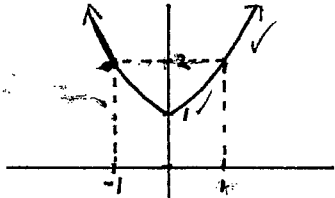

2.

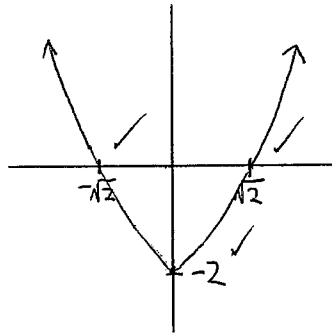

3.

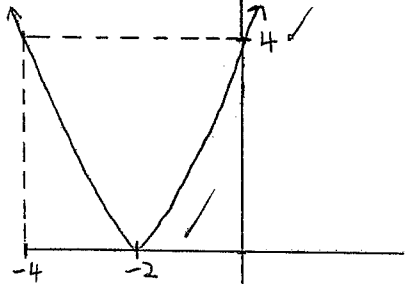

4.

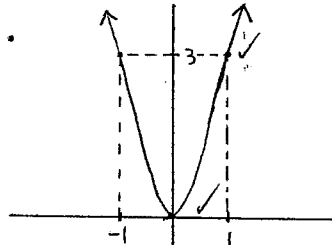

5.

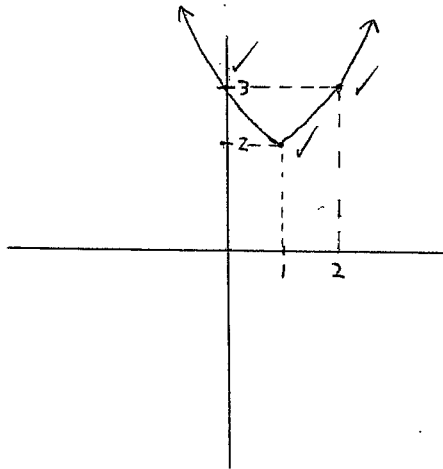

6.

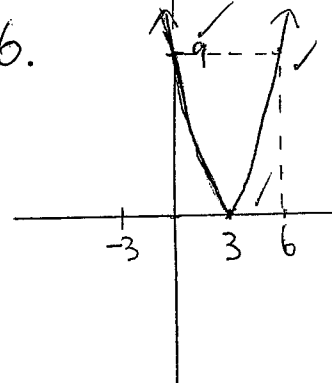

7.

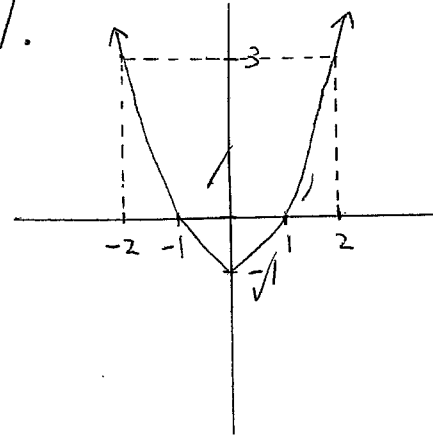

9.

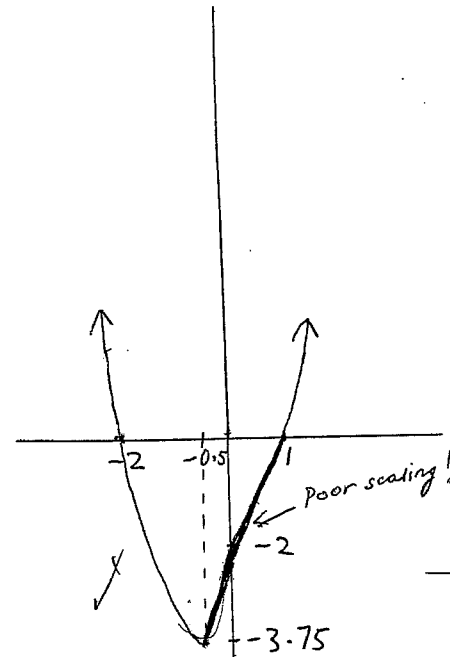

8.

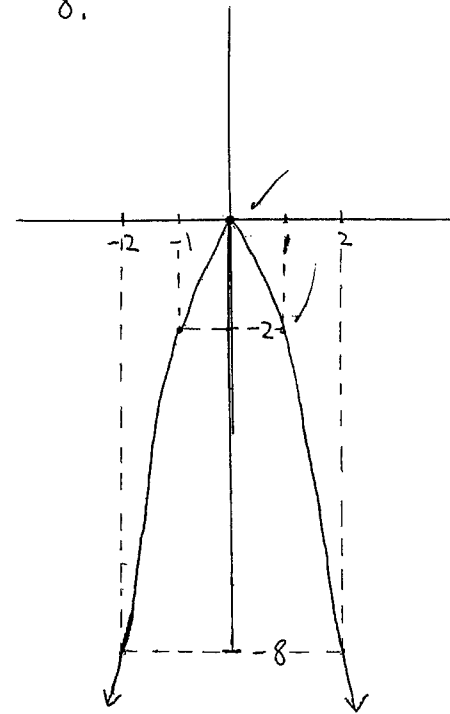

10.

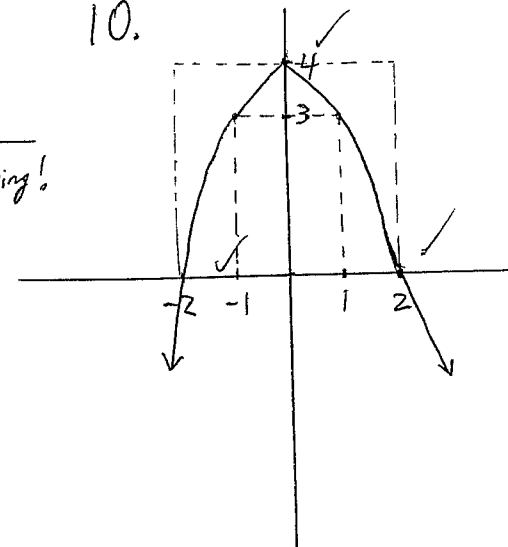

11.

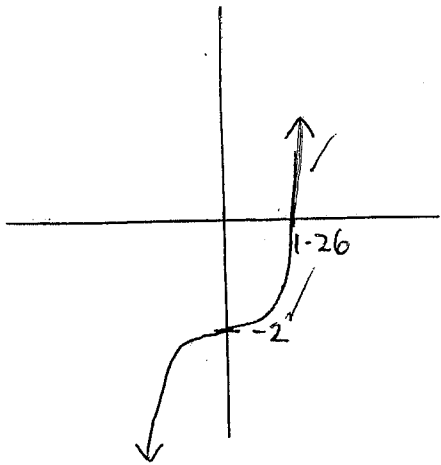

12.

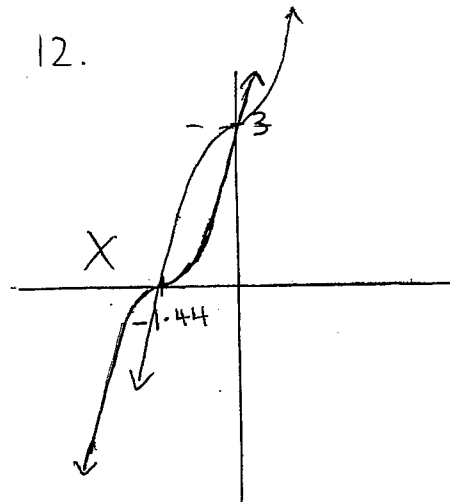

17.

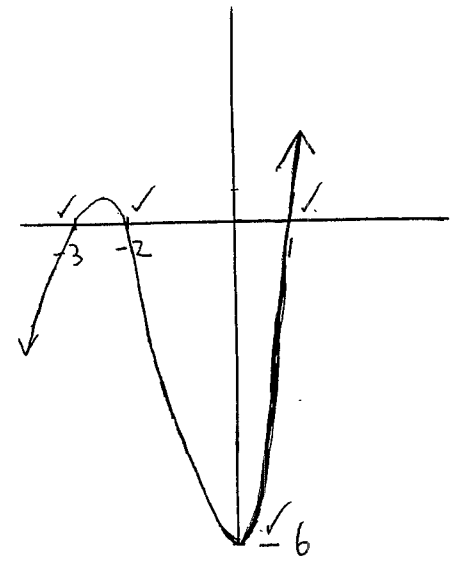

18.

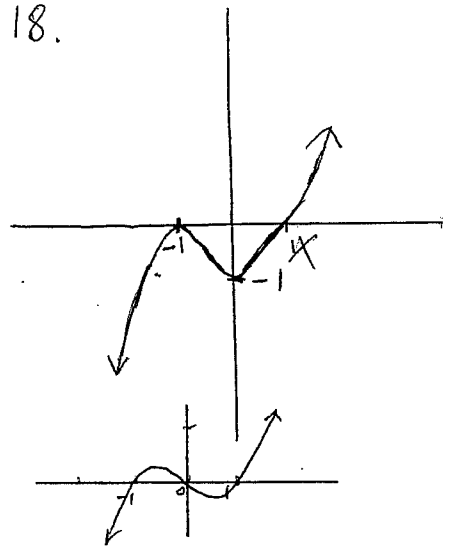

13.

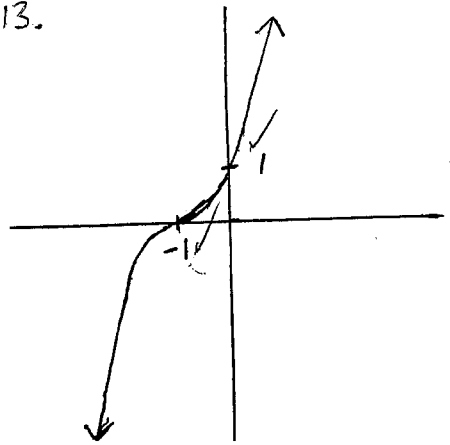

14.

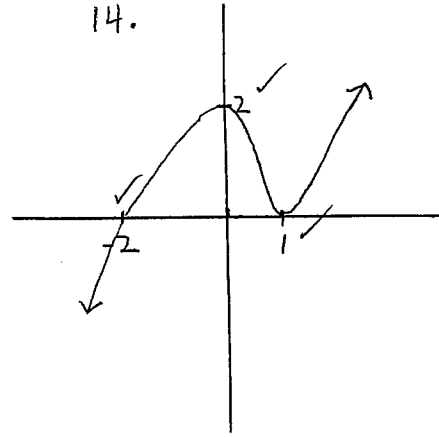

19.

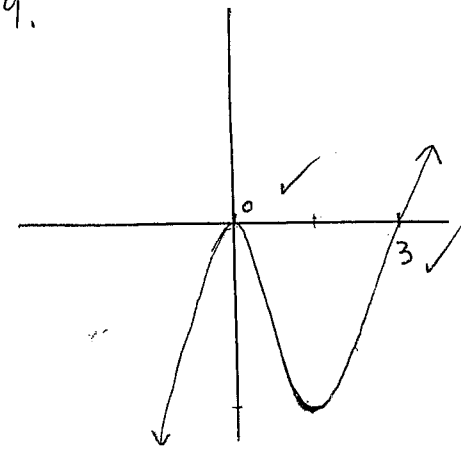

20.

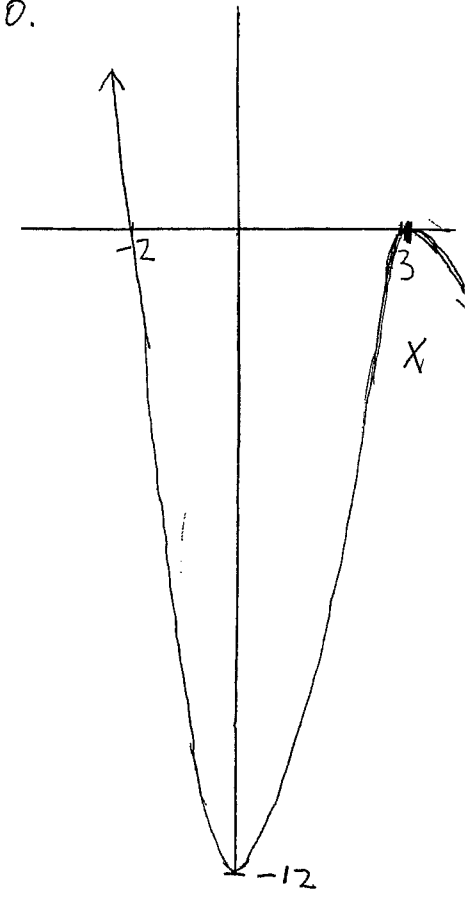

15.

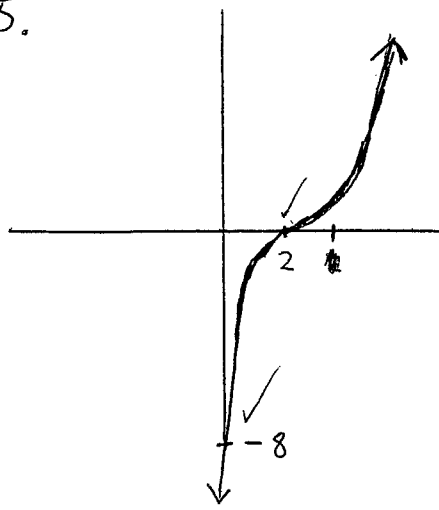

16.

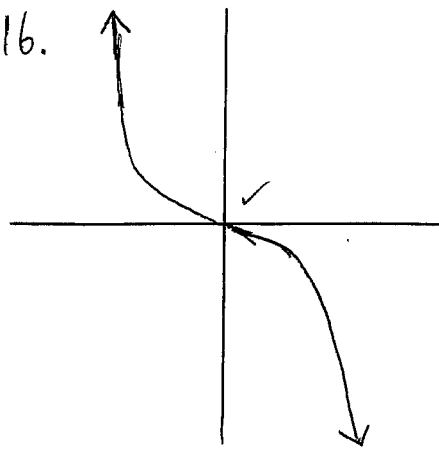

(20)

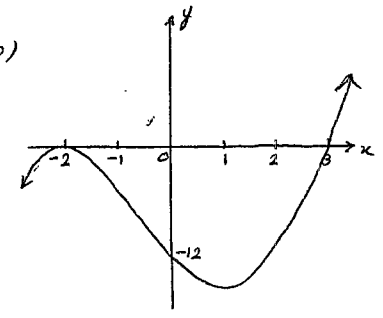

# HYPERBOLAE

21.

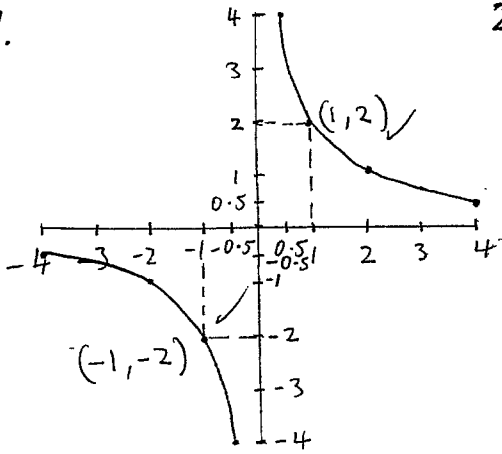

22.

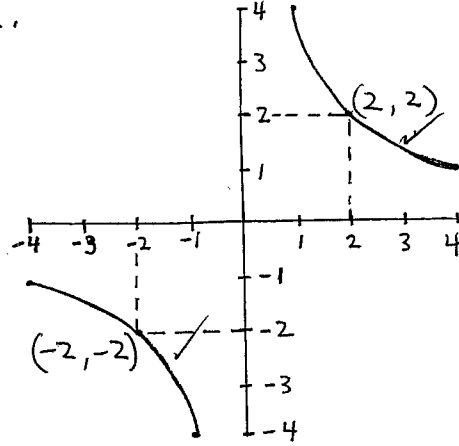

28.

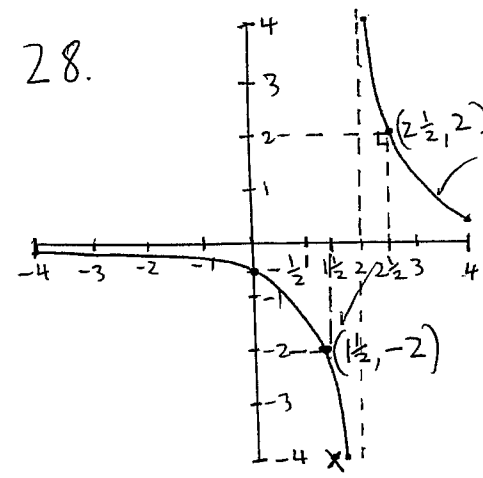

29.

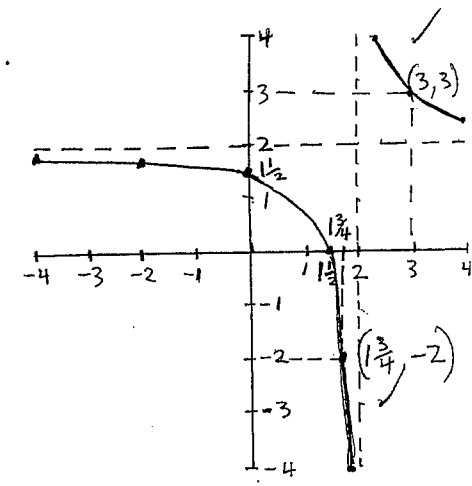

23.

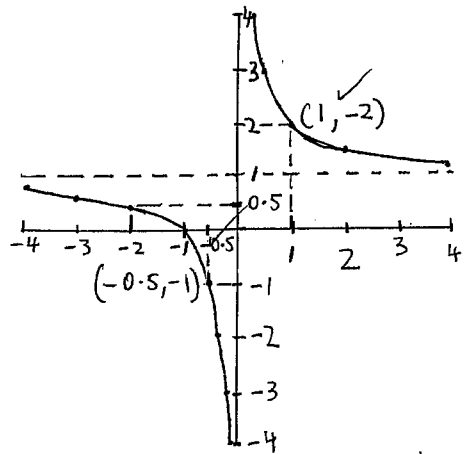

24 & 25.

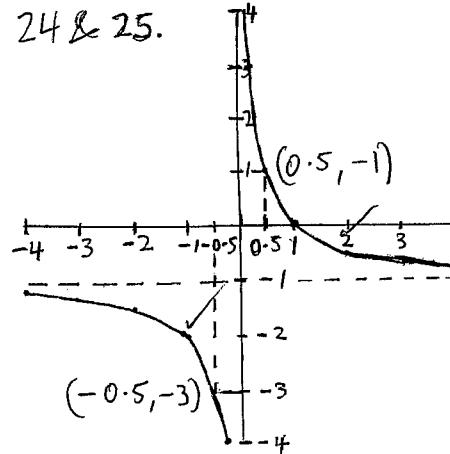

30.

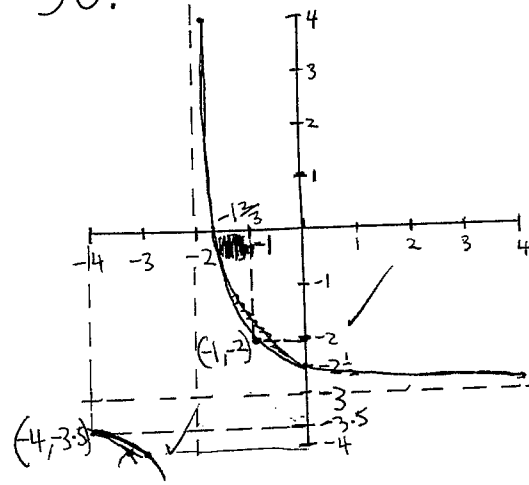

26.

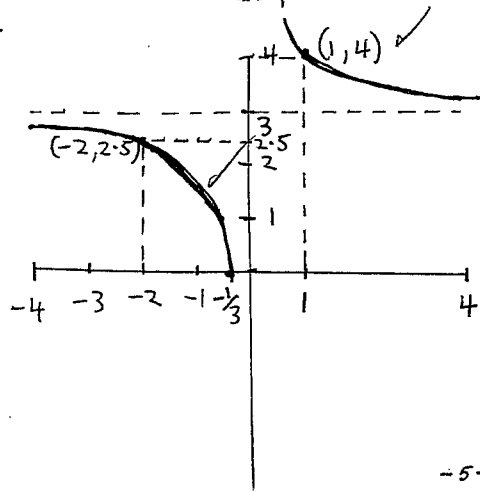

27.

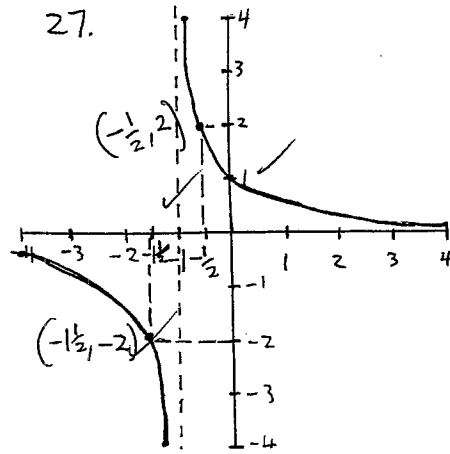

# EXPONENTIALS

31.

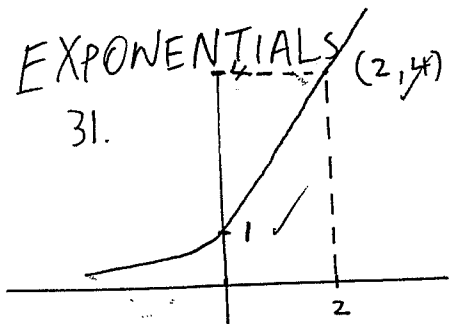

32.

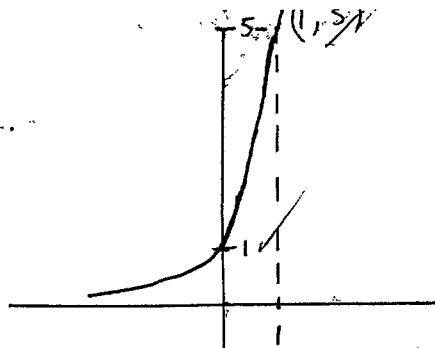

37.

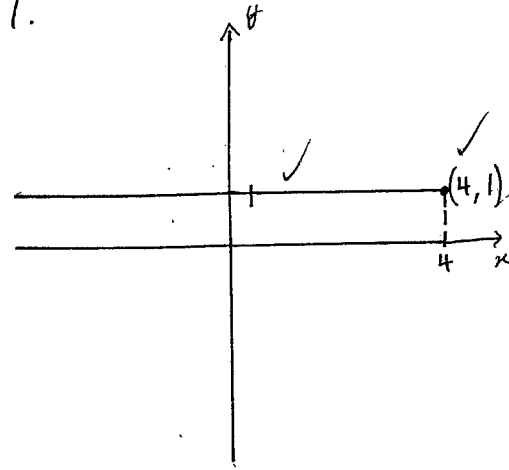

38.

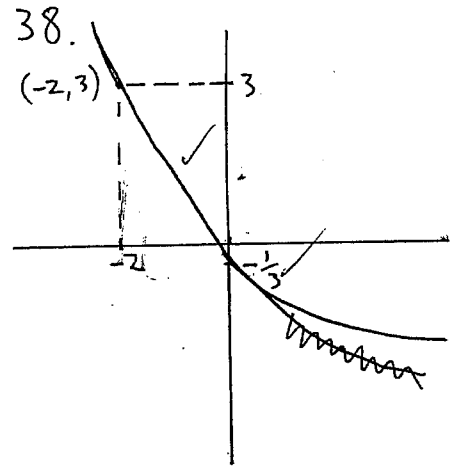

33.

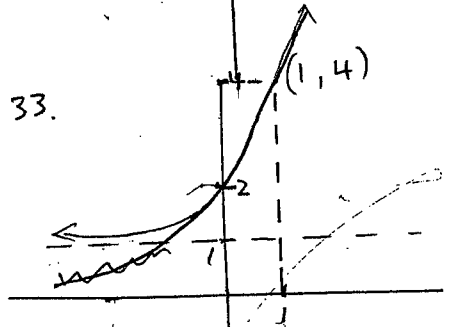

34.

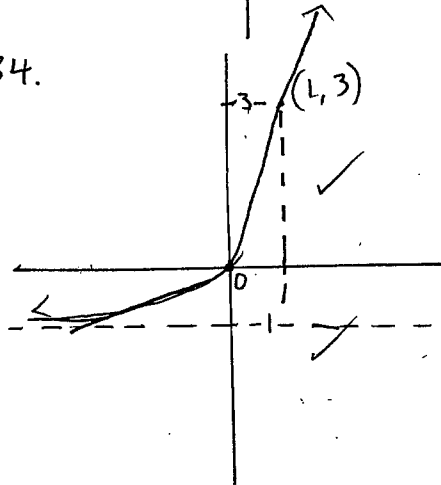

39.

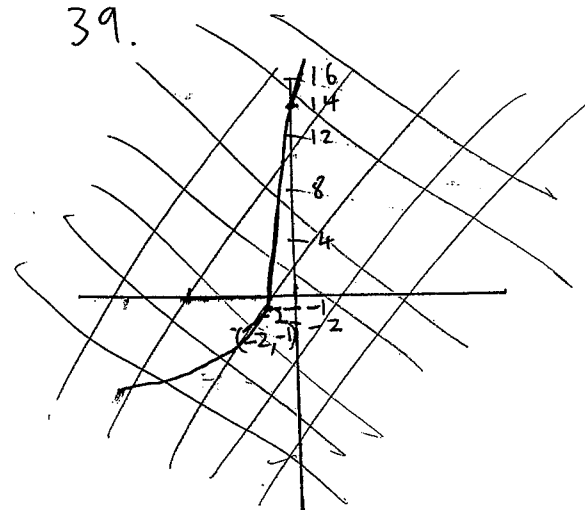

40.

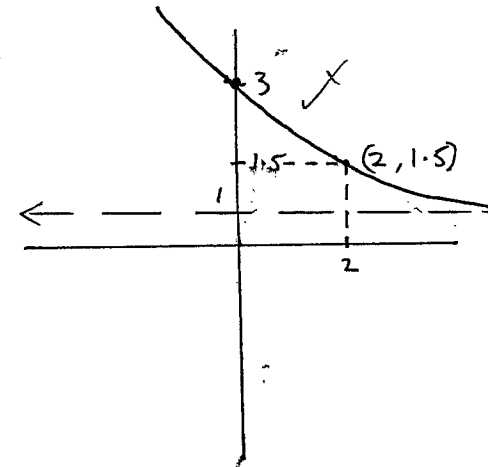

35.

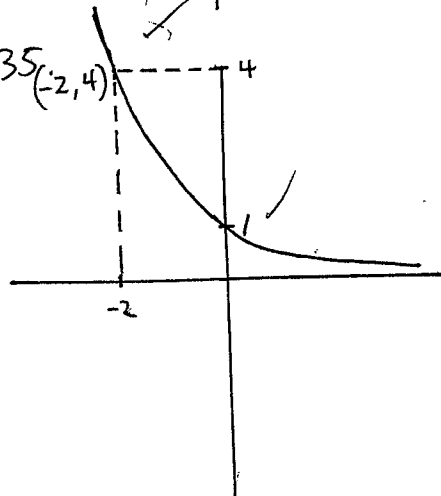

36.

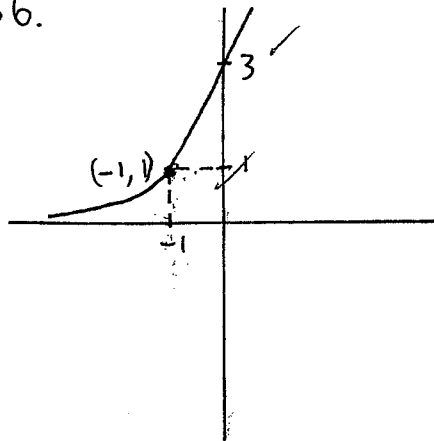

39.

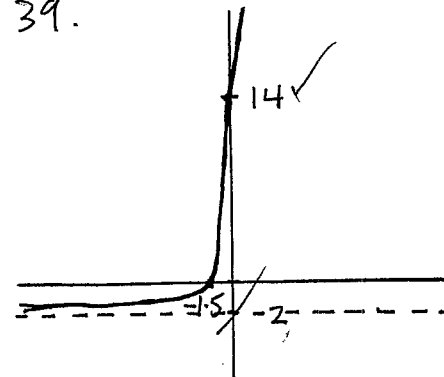

41.

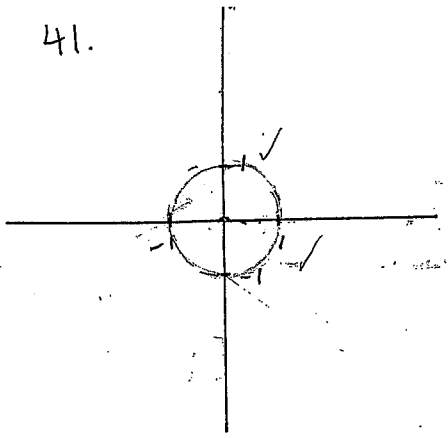

42.

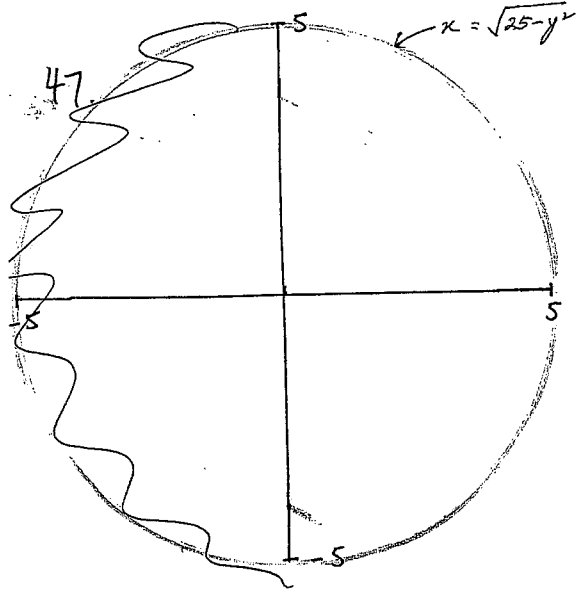
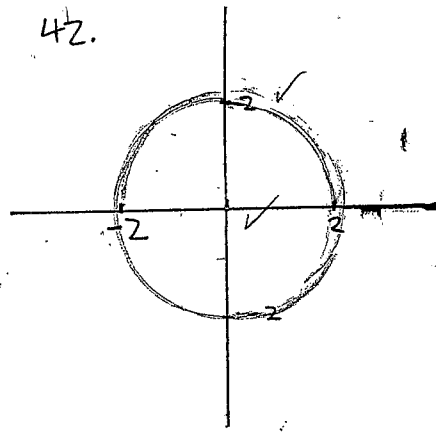

48.

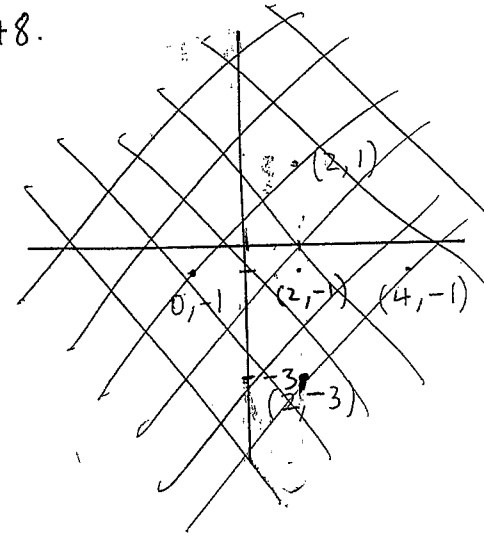

43.

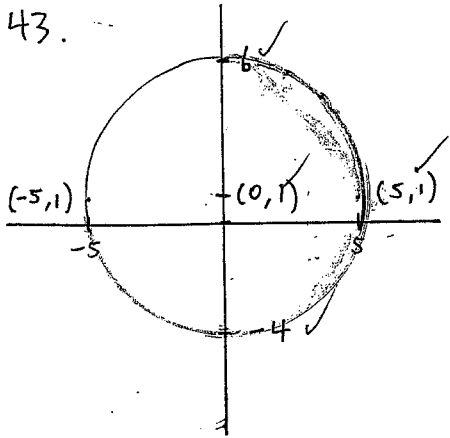

44.

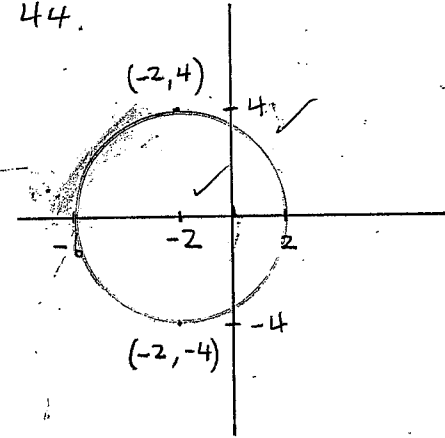

48.

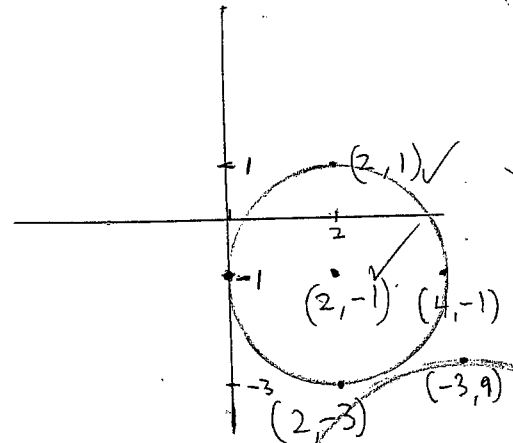

49.

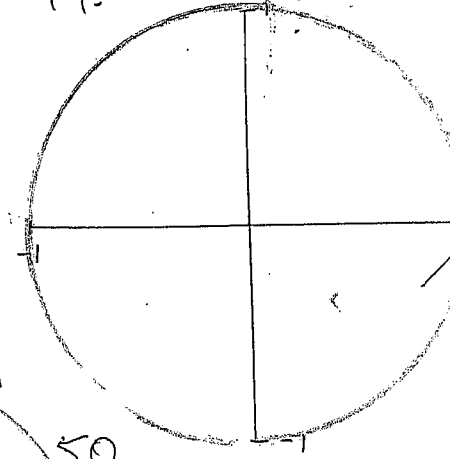

45.

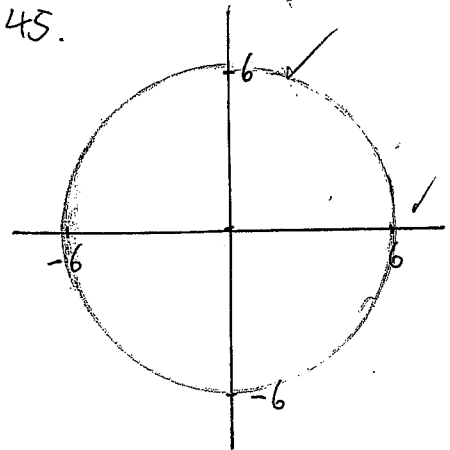

46.

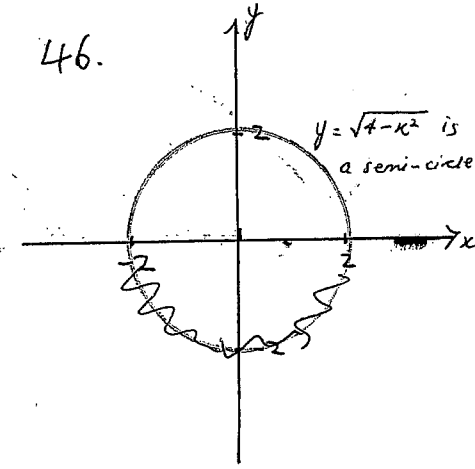

50.

