

MIKE BELL MAPS RETAIL BROCHURE

SPRING 2025



”
LOVELY STUFF, IN A FRAME
IN THE "FALL CORNER"
OF MY MUSIC ROOM.

★★★★★
S.F. ✓

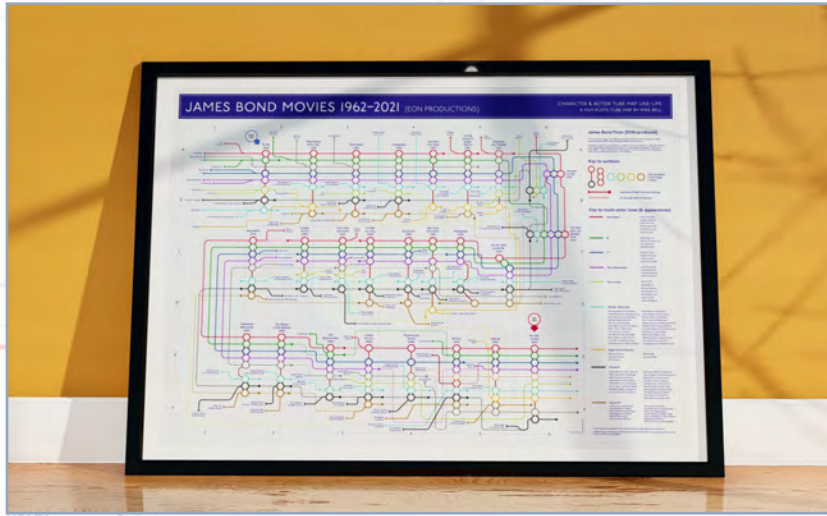

”
EXCELLENT GIFT FOR MY
ABBA-MAD FRIEND

★★★★★
T ✓

”
WE HAVE TWO MAPS. FOO FIGHTERS
AND CHILI PEPPERS. I LOVE THEM
...THEY WILL TAKE PRIDE OF PLACE
IN OUR LIVING ROOM..
GREAT STANDARD

★★★★★
A ✓

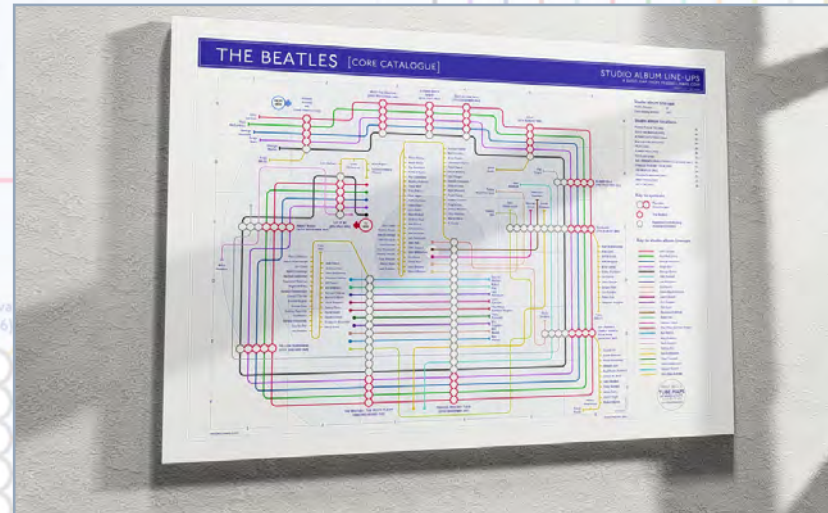

”
EXCELLENTLY DESIGNED MAPS
AND DELIVERED QUICKLY.

★★★★★
T.V. ✓

ART TO EXPLAIN

WWW.MIKEBELLMAPS.COM | MIKE@MIKEBELLMAPS.COM

Studi

- 1. Ring Ri
- 2. Water
- 3. ABBA |
- 4. Arriva
- 5. ABBA.
- 6. Voulet
- 7. Super
- 8. The Vi
- 9. Voyag

Key t



Key 2



“YOUR WORK IS VERY
COOL AND SMART”

DR. SUSAN ROGERS
PRINCE'S PRODUCER

ABOUT MIKE:

I'M MIKE BELL, A UK-BASED DESIGNER SPECIALIZING IN UNIQUE MAPS CHARTING THE RECORDING HISTORIES OF BANDS, FILM PLOTS & MORE. MY BACKGROUND IS IN STAGE DESIGN, HAVING STARTED MY CAREER IN LIVE MUSIC, MOVING ACROSS TO EVENT PRODUCTION AND THEN SHOW DESIGN.

WHEN LOCKDOWN HIT AND MY 3D EVENT WORK VANISHED, I NEEDED A NEW CHALLENGE TO KEEP MY CREATIVITY ALIVE WHILE WAITING FOR FREELANCE WORK TO RETURN.

I BECAME FASCINATED BY THE INTRICATE STORIES OF BANDS AND THEIR STUDIO JOURNEYS, GOING BEYOND TYPICAL FAMILY TREES TO EXPLORE THE CONNECTIONS BETWEEN SESSION MUSICIANS, GUEST ARTISTS, AND THE BROADER LANDSCAPE OF BAND AND SOLO ARTIST DISCOGRAPHIES.

YOU CAN FIND THESE MAPS AT MY BRICK-AND-MORTAR STORE IN LEWES OR PURCHASE THEM ONLINE. MY COLLECTION HAS SINCE EXPANDED TO INCLUDE FILM PLOTS, POLITICAL SATIRE, FI, AND MORE!



MIKE BELL MAP | STUDIO & SHOP LEWES

“**AWESOME**”
WARREN ELLIS

RESIDENT MUSIC A RETAILER'S STORY:



RESIDENT MUSIC | RETAIL DISPLAY | BRIGHTON

“WE STARTED WORKING WITH MIKE OVER XMAS '23 AND WERE TAKEN ABACK BY HOW QUICKLY (THE MAPS) WERE FLYING OFF THE SHELVES, AND THEY'VE CONTINUED SELLING WELL SINCE.

(THEY) ARE RICHLY DETAILED AND WELL PUT TOGETHER AND FEEL LIKE THE PERFECT GIFT FOR PEOPLE WHO LOVE TO SHOW OFF THEIR MUSIC KNOWLEDGE AND HAVE AN APPRECIATION FOR THE DETAIL AND COMPLEXITY OF THEIR FAVOURITE ARTISTS' CAREERS.”

HOW THE MUSIC MAPS WORK

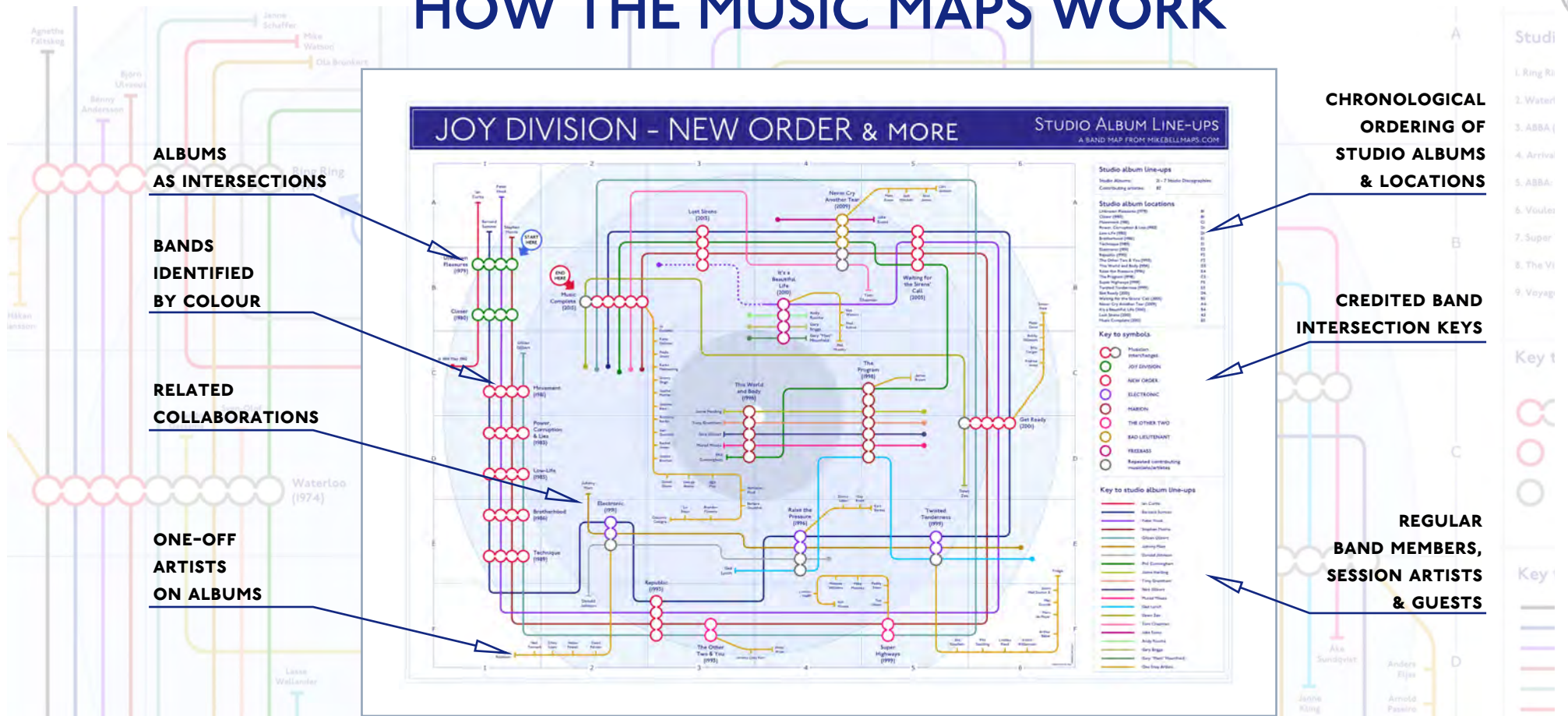

“BRILLIANT IDEA”
BILLY BRAGG

ATTACHED, YOU'LL FIND A DETAILED PRICE LIST OUTLINING THE RECOMMENDED RETAIL PRICES FOR MY PRODUCTS AND WHOLESALE PRICES.
A5 GREETING CARDS, A4, A3, & A2 ART PRINTS
I SUPPLY A STOCK OF ITEMS AND BILL ON 30-DAY SETTLEMENT.
ALL RETAIL SALES ARE VAT REGISTERED.

SHOULD YOU HAVE ANY QUESTIONS OR WISH TO DISCUSS THIS OPPORTUNITY FURTHER, PLEASE DON'T HESITATE TO CONTACT ME:

MUSIC MAP SELECTION

TAYLOR SWIFT

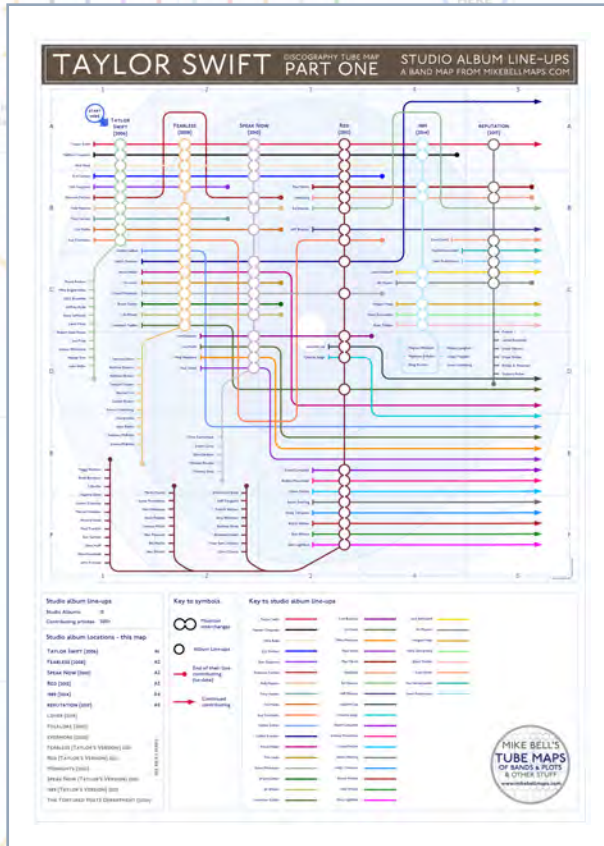

ABBA

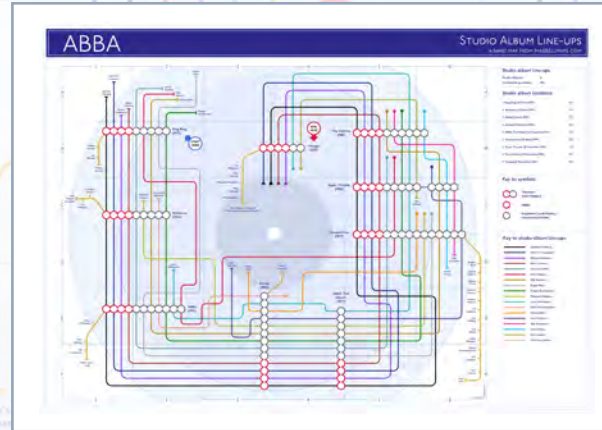

THE BEATLES

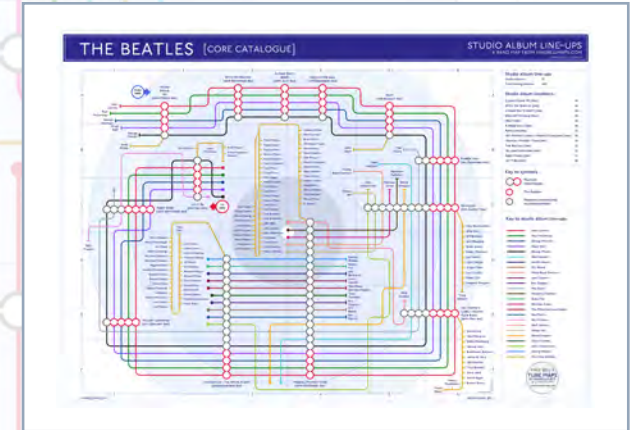

“BRILLIANT SERIES”
SIMON ROGERS
THE FALL / PRODUCER

FOO FIGHTERS / NIRVANA

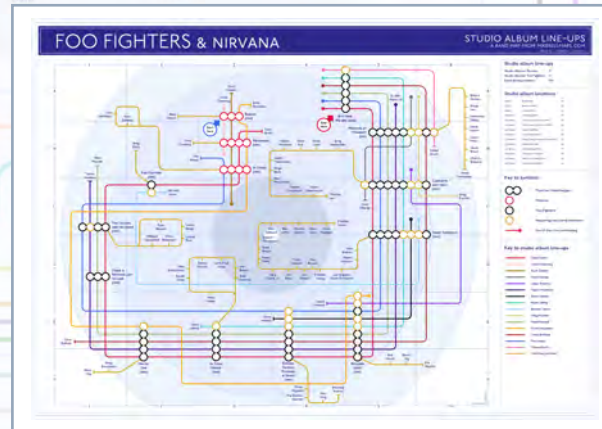

NICK CAVE

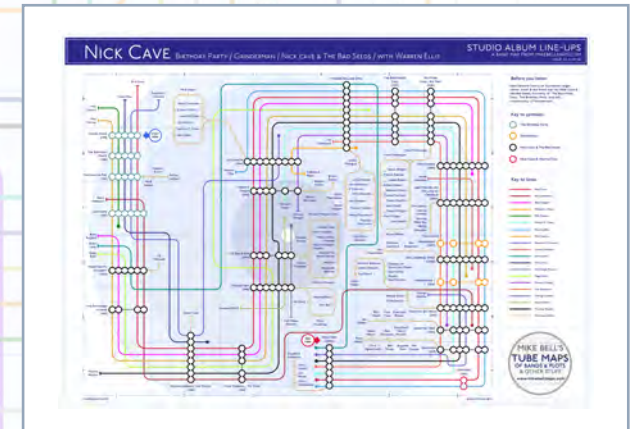

DAVID BOWIE STUDIO ALBUM DISCOGRAPHY MAP

STUDIO ALBUM LINE-UPS

A BAND MAP FROM MIKEBELLMAPS.COM
UPDATED 03 - 17-10-24

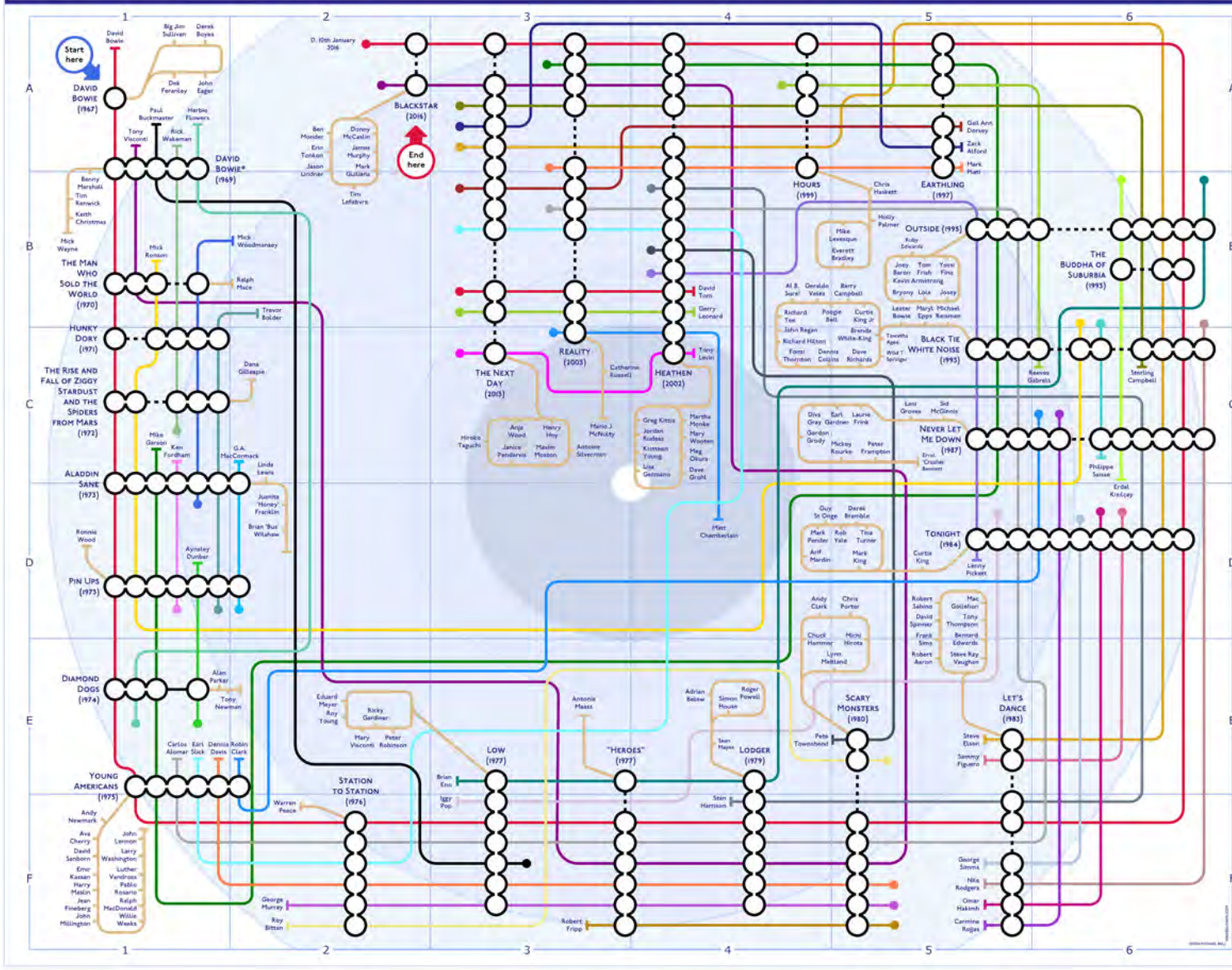

Studio album line-ups
Studio Albums: 26
Contributing artists: 170+

Studio album locations

David Bowie (1967)	AI	Let's Dance (1983)	AI
*David Bowie (1969) - ref as 'Space Odyssey'	AI	Tonight (1984)	AI
The Man Who Sold the World (1970)	BI	Never Let Me Down (1987)	CI
Hunky Dory (1971)	CI	Black Tie White Noise (1993)	CI
The Rise and Fall of Ziggy Stardust and the Spiders from Mars (1972)	CI	The Buddha of Suburbia (1995)	BI
Aladdin Sane (1973)	CI	Outside (1995)	BI
Pin Ups (1973)	CI	Kentucky (1997)	BI
Diamond Dogs (1974)	BI	Mirrors (1999)	BI
Young Americans (1975)	BI	Heathen (2002)	CI
Station to Station (1976)	FJ	Reality (2003)	CI
Low (1977)	CI	The Next Day (2013)	CI
"Heroes" (1977)	CI	Blackstar (2016)	AJ
Lodger (1979)	CI	Blackstar (2016)	AJ
Scary Monsters (1980)	CI	Blackstar (2016)	AJ
Let's Dance (1983)	CI	Blackstar (2016)	AJ

Key to symbols

Musician interchanges

End of their line contributing

- Key to studio album line-ups
- David Bowie
 - Zack Alford
 - Carlos Alomar
 - Roy Bittan
 - Trevor Bolder
 - Paul Buckmaster
 - Starling Campbell
 - Matt Chamberlain
 - Robin Clark
 - Dennis Davis
 - Gail Ann Dorsey
 - Aynsley Dunbar
 - Steve Elson
 - Brian Eno
 - Sammy Figueroa
 - Herbie Flowers
 - Ken Fordham
 - Robert Fripp
 - Reeves Gabrels
 - Mike Garson
 - Omar Hakim
 - Stan Harrison
 - Ernie Kendrick
 - Gerry Leonard
 - Tony Levin
 - G.A. MacCormack
 - George Murray
 - Lenny Pickett
 - Mark Platt
 - Aggie Papp
 - Nick Rodgers
 - Carmine Rojas
 - Mick Ronson
 - Philippe Saisse
 - George Simms
 - Earl Slick
 - Nick Slick
 - David Tom
 - Pete Townshend
 - Tony Visconti
 - Rick Wakeman
 - Mick Woodmansey
 - One Stop Artists

FILM PLOT MAP SELECTION

BOND MOVIES

THE SHINING

JAWS

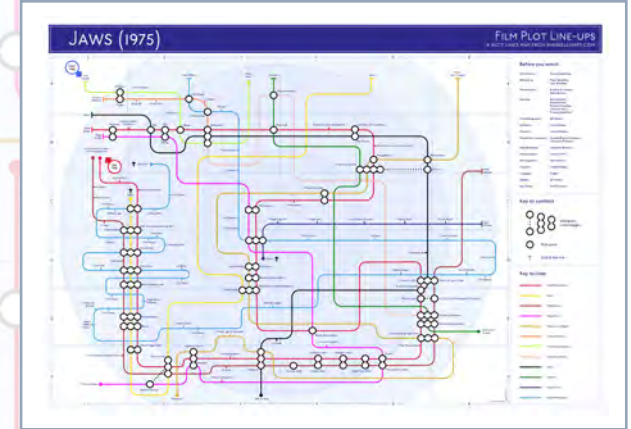
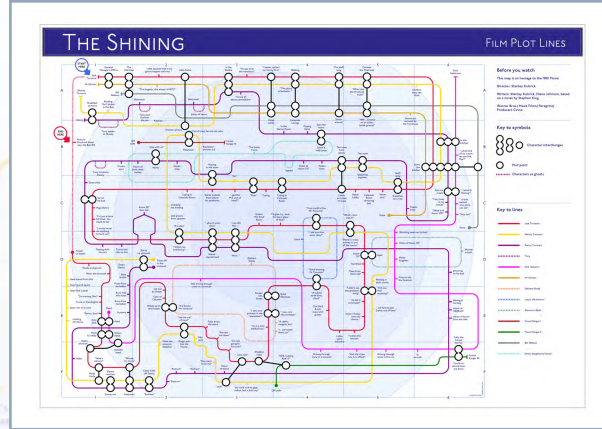
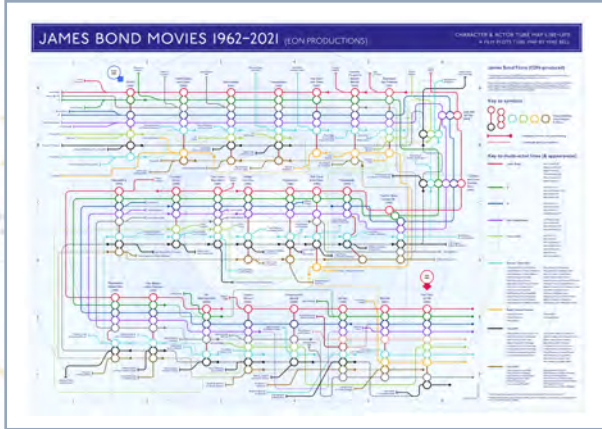

“THE PERFECT GIFT”
RESIDENT MUSIC

BACK TO THE FUTURE

DIRTY DANCING

BLADE RUNNER

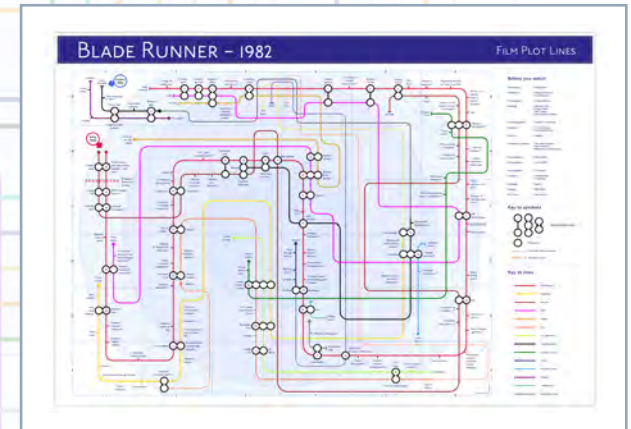
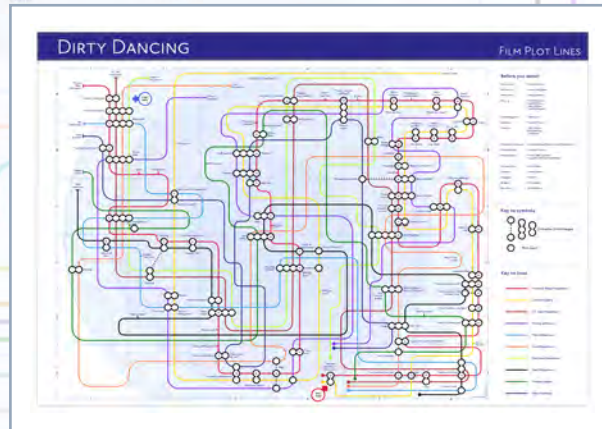
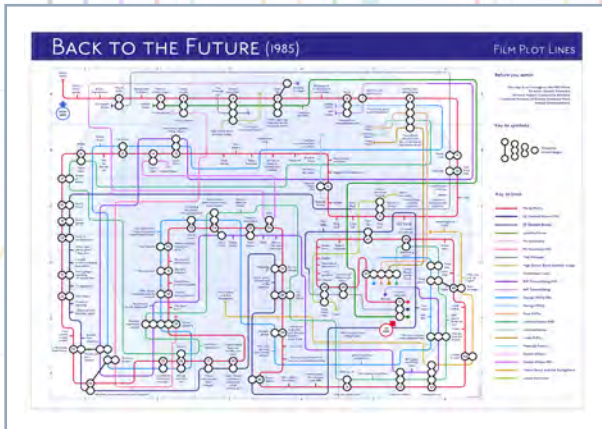

THE SHINING

FILM PLOT LINES

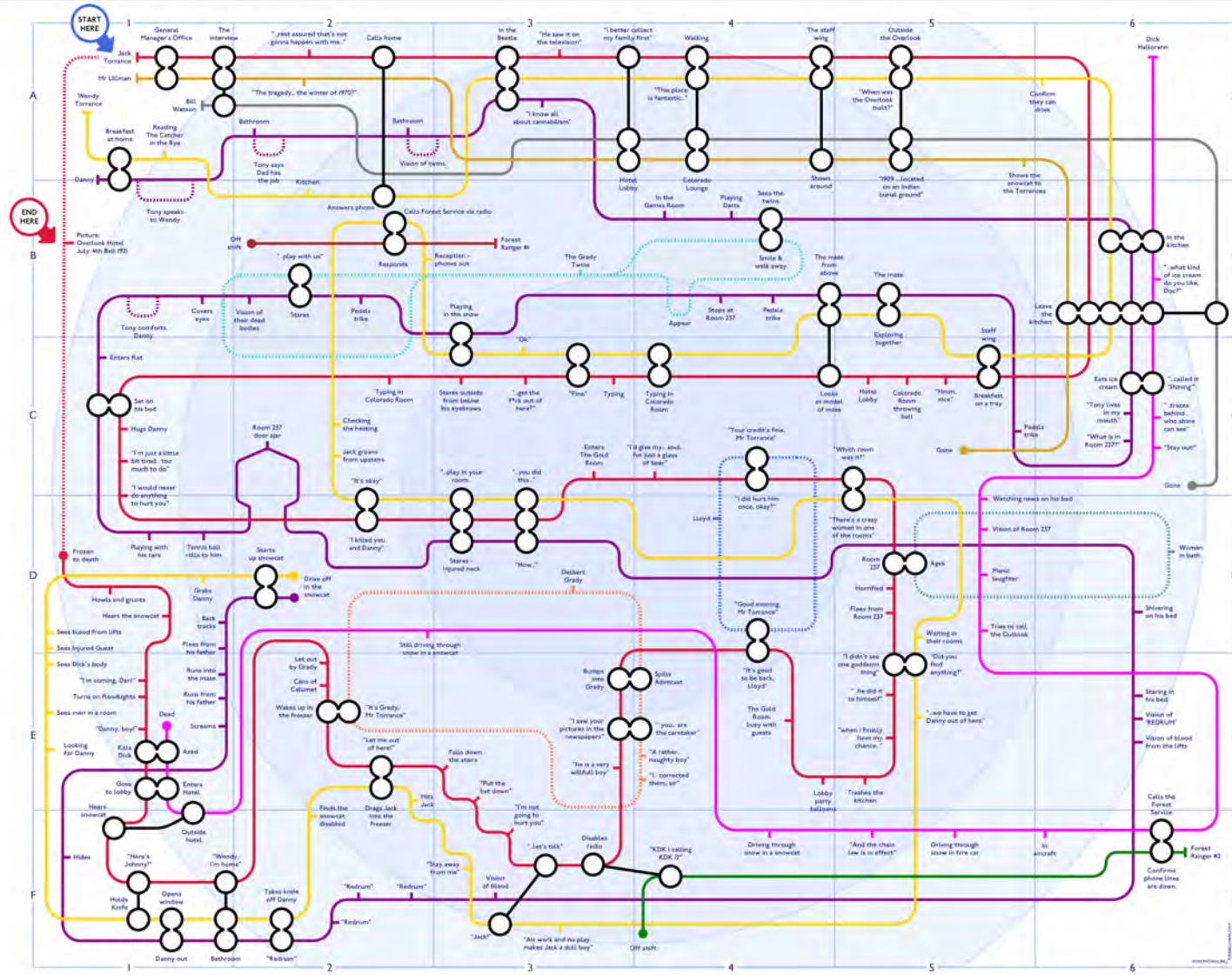

Before you watch
 This map is an homage to the 1980 Movie
 Director: Stanley Kubrick
 Writers: Stanley Kubrick, Diane Johnson, based on a novel by Stephen King
 Warner Bros / Hawk Films / Peregrine / Producers Circle

Key to symbols
 Character interchanges
 Plot point
 Characters as ghosts

Key to lines

- Jack Torrance
- Wendy Torrance
- Danny Torrance
- Tony
- Dick Halloran
- Mr Ullman
- Dickert Grady
- Lloyd, the barman
- Women in Bath
- Forest Ranger 1
- Forest Ranger 2
- Bill Watson
- Grady Daughters (Twins)

FILM PLOT SAMPLE

OTHER SUBJECTS

FOOTBALL

POLITICAL HISTORY

POLITICAL SATIRE

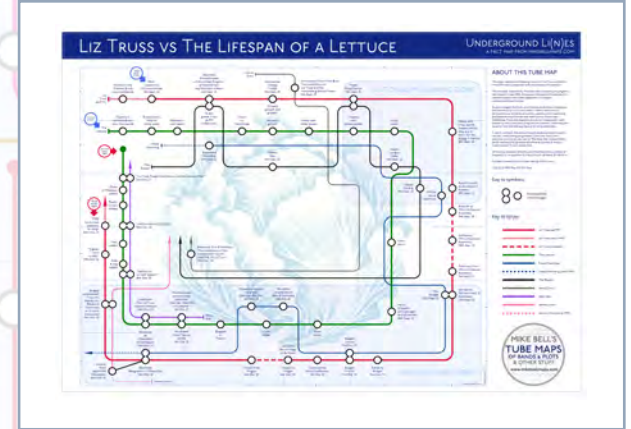
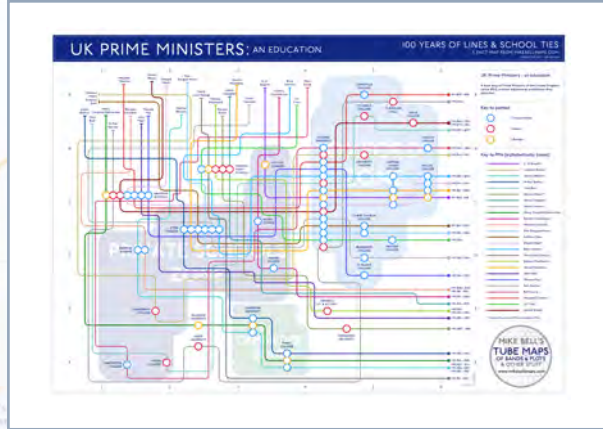
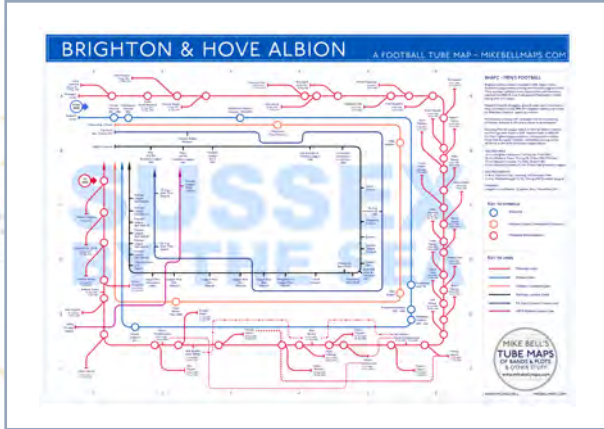

POLITICAL FACTS

FORMULA ONE

PRODUCTION

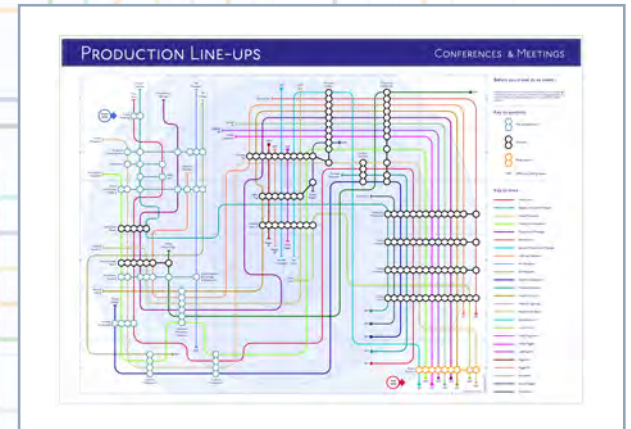
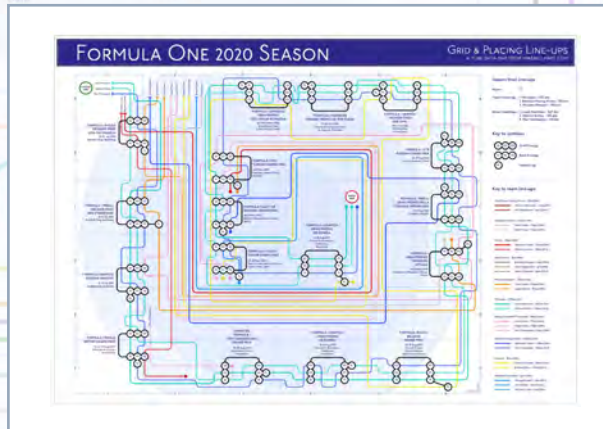
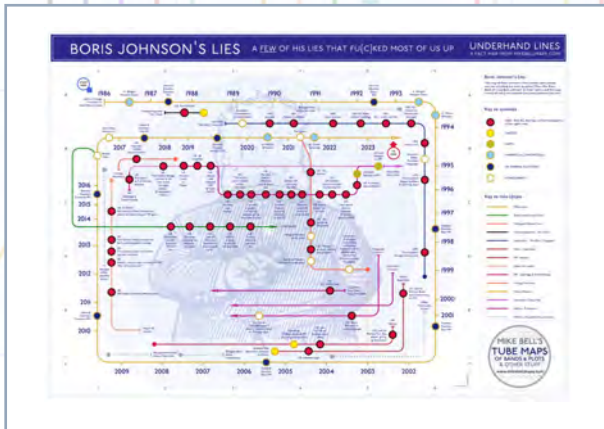

IT'S IN THE DETAIL .. CONNECTING MORE

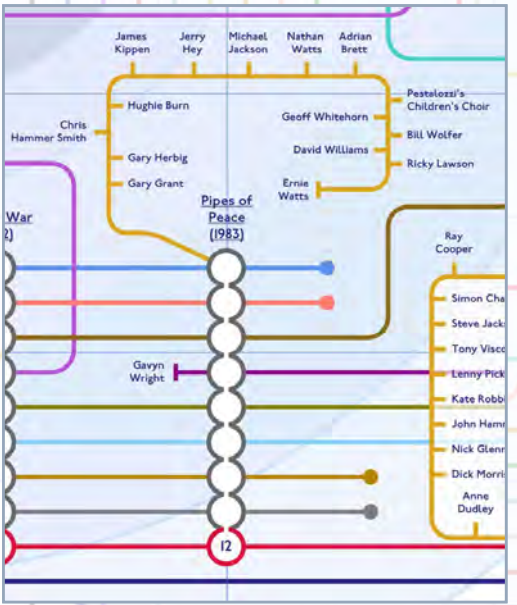
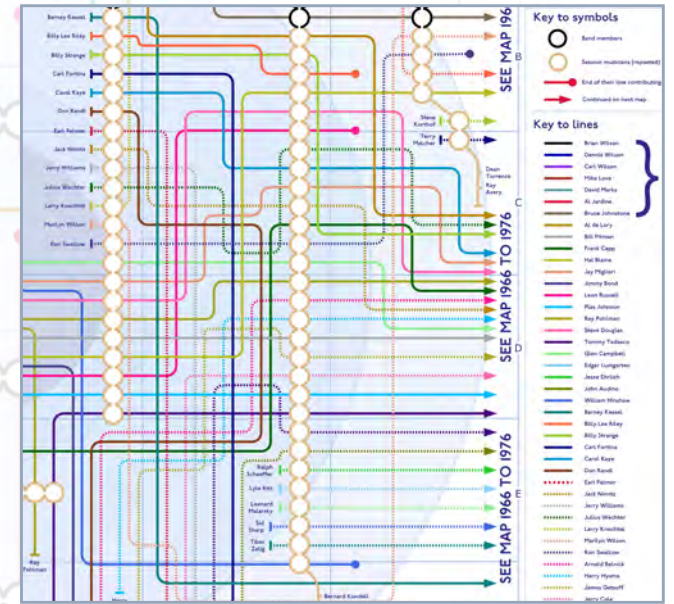
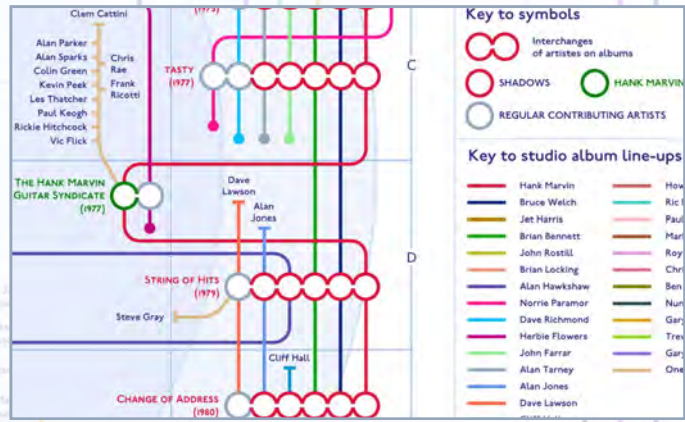
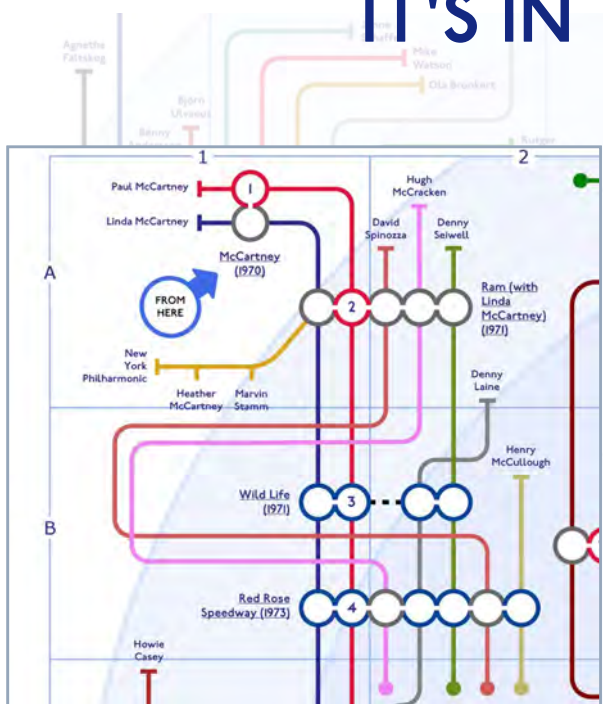

PRODUCT FORMATS

ART PRINTS: 210 GSM+ FINE PAPER | SIZES: A4 / A3 / A2

ART PRINTS IN BIO-DEGRADABLE BAGS/RECYCLED BACKINGS
FSC PAPER / RE-CYCLED STOCKS USED WHEREVER POSSIBLE

POSTERS: 130 GSM | SIZES: A3 / A2

POSTERS IN CARDBOARD TUBES
FSC PAPER / RE-CYCLED STOCKS USED WHEREVER POSSIBLE

Z-FOLD MAPS: 130 GSM | SIZE - EXPANDS TO A2

Z-FOLD MAPS IN BIO-DEGRADABLE BAGS/RECYCLED BACKINGS
FSC PAPER / RE-CYCLED STOCKS USED WHEREVER POSSIBLE

GREETING CARDS (BLANK) WITH ENVELOPE | SIZE: A5

GREETING CARDS IN BIO-DEGRADABLE BAGS/RECYCLED BACKINGS
FSC PAPER / RE-CYCLED STOCKS USED WHEREVER POSSIBLE

JIGSAW PUZZLES - 500 / 1,000 PIECE

100% RECYCLED BOARD | UK-MADE | COMPLETED: 66 X 50 CM

ART PRINTS ON ALUMINIUM: LIMITED EDITIONS

BRUSHED ALUMINIUM - ARTBOX FRAMED
IMAGE 56.6 X 40 CM / OUTER 57.8 X 41.2 CM

LEAD TIMES VARY ACROSS ALL PRODUCTS - DELIVERY ESTIMATE GIVEN ON ORDER



WINTER '24 PRODUCT LIST

MUSIC MAPS

ABBA
THE BEACH BOYS 1962-65 - MAP 1 OF 3
THE BEATLES
BILLY BRAGG
BLONDIE / DEBBIE HARRY SOLO
BOB MARLEY & THE WAILERS
BRUCE SPRINGSTEEN
THE BYRDS
THE CHARLATANS
CROWDED HOUSE
CURE, THE
DAVID BOWIE
DEEP PURPLE
DIRE STRAITS / JOHN ILLSLEY
ECHO & THE BUNNYMEN
EDWYN COLLINS / ORANGE JUICE
ELO
THE FALL
FLEETWOOD MAC
FOO FIGHTERS / NIRVANA
GEORGE HARRISON
HAWKWIND
HOUSEMARTINS/ BEAUTIFUL SOUTH, THE
JETHRO TULL
JOE JACKSON
JOHN LENNON
JOHN LYDON / SEX PISTOLS / PIL
JOHNNY MARR (INC THE SMITHS)
JOY DIVISION - NEW ORDER & MORE
KATE BUSH
THE KINKS

LEONARD COHEN
LEVELLERS
LLOYD COLE / THE COMMOTIONS
MANIC STREET PREACHERS
MATT JOHNSON / THE THE
MORRISSEY (INC THE SMITHS)
MUMFORD & SONS
NICK CAVE
OASIS & LIAM AFTERWARDS
OASIS & NOEL AFTERWARDS
OASIS REUNITED
OMD
PAUL MCCARTNEY
PAUL WELLER
PINK FLOYD
QUEEN
R.E.M.
RAMONES
RED HOT CHILI PEPPERS
THE ROLLING STONES
THE ROLLING STONES - GOATS HEAD SOUP
SHADOWS - HANK MARVIN
SIMPLE MINDS
THE SMITHS, THE SPLIT
SPARKS
SQUEEZE
STEELY DAN
THE STRANGLERS
TAYLOR SWIFT - THREE MAPS
TOM PETTY / HEARTBREAKERS / WILBURYS
THE WHO
Z-FOLD - DAVID BOWIE

FILM PLOT LINE MAPS

BACK TO THE FUTURE (1985)
BLADE RUNNER (1982)
DIRTY DANCING
JAMES BOND FILMS
JAWS
THE SHINING

POLITICAL LI(N)ES MAPS

BORIS JOHNSON'S FIRST 1,000 DAYS & PARTIES
LIZ TRUSS VS THE LIFESPAN OF A LETTUCE
UK PRIME MINISTERS
BORIS JOHNSON'S LIES
BREXIT BENEFITS
TAN LINES OF THE WHITE RIGHT
NO 'ISTS

SPORTS

BRIGHTON & HOVE ALBION HISTORY MAP
FORMULA ONE - 1984 SEASON
FORMULA ONE - 1986 SEASON
FORMULA ONE - 2019 SEASON
FORMULA ONE - 2020 SEASON



BELLAMY'S LIMITED | COMPANY REG: 06614918 | VAT REG: 131 1475 52
REG OFFICE: HORNS LODGE MERES LANE HEATHFIELD TN21 0TY

WWW.MIKEBELLMAPS.COM | MIKE@MIKEBELLMAPS.COM