



SHELL SCHEME FOR EXHIBITIONS AND EVENTS

COMPLETE



FEATURES

Your shell scheme stand can be enhanced with a range of optional features to create the perfect environment for displaying your products or services.

STORAGE AREA (SA): ENCLOSURE PARTITIONING (WP)

These panels are required to create separate storage, cloakrooms or office areas.

2500mm x 992mm

DISPLAY PANELS

Available in two sizes:
DP1 = 1000mm x 1000mm
DP2 = 2000mm x 1000mm

With a variety of colours available, display panels can be used for graphics and small exhibits. Items can be fixed with hooks, Velcro or pins.

RAISED PLATFORM (RP)

Platform with 100mm black skirting covered with 18mm ply. This is a convenient way to conceal pipe work, cabling or plumbing.

FLOOR FLATS

18mm plywood used for carpeted venues if a change of carpet colour is required. Aluminium edging is needed for open sided stands.





SLAT WALL PANEL (SWP)

2360mm x 992mm
Hooks not included.



FLAT SHELVES (FS)

992mm x 300mm ideal for exhibits or literature.



SLOPING SHELVES (SS)

992mm x 300mm ideal for exhibits or literature.



MUSLIN CEILING (MC)

Create that intimate atmosphere on your stand. Available in white or other colours, including black, on request.



DOOR (EWD) OR CURTAINED ENTRANCE (EWC)

Can be used to create an enclosed area along with a Wall Panel (WP)
2500mm x 992mm



GARMENT HANGING RAIL (GHR)

A simple rail 992mm long



SINK UNIT

Basic sink units can be installed where needed. Please contact your venue about water and waste facilities.



NIGHTSHEETS (NS)

Although not a security device, night sheets act as a deterrent and are supplied with a padlock.

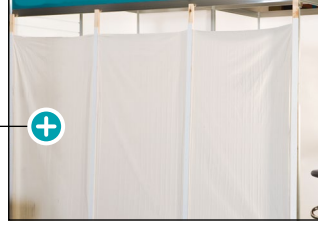
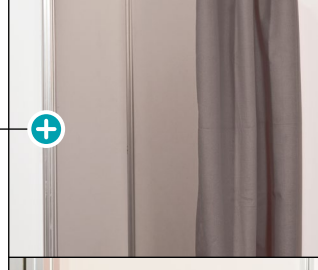
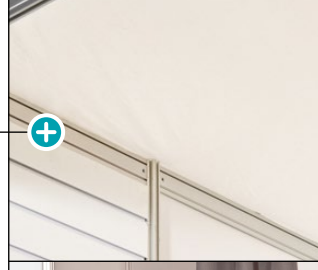
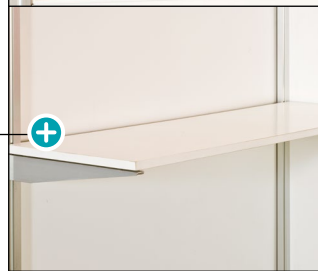
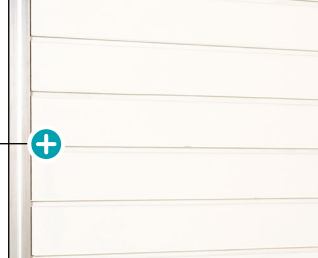

PLASMA SCREEN

Please contact our ServiCentre for advice on plasma screens

To order visit ordering.ges.com (select GES UK from the drop down) or call our ServiCentre on +44 (0)2476 380 183

Please note: All measurements are in millimetres DIA = diameter D = depth H = height W = width SH = seat height L = length
These images are examples only, your shell scheme may vary

SPECIFICATIONS

BASIC SHELL SCHEME

- Name Panel
- Fascia
- Ceiling Beams
- Modular Wall Panels in white
- Intermediate support on all frontages in excess of 4m
- Corner support

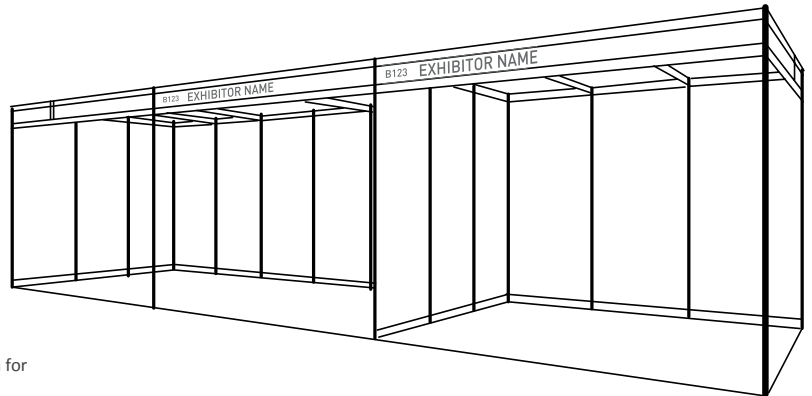

The illustration depicts typical sites. Check your own space allocation for dimensions, number and location of open frontages etc.

SHELL DIMENSIONS

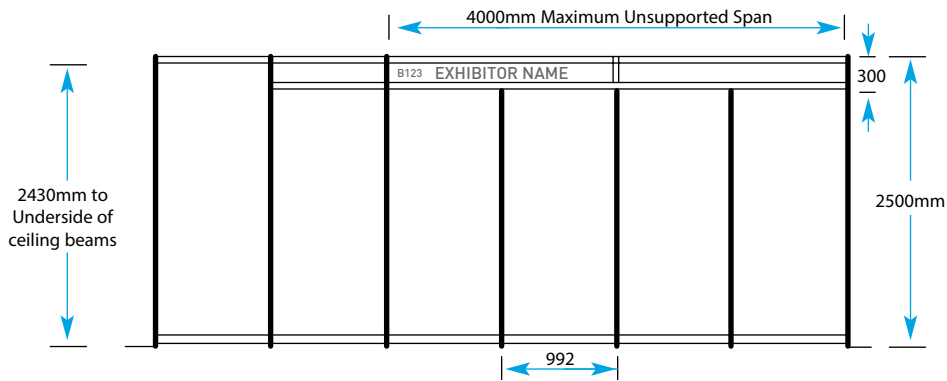

PANEL DIMENSIONS

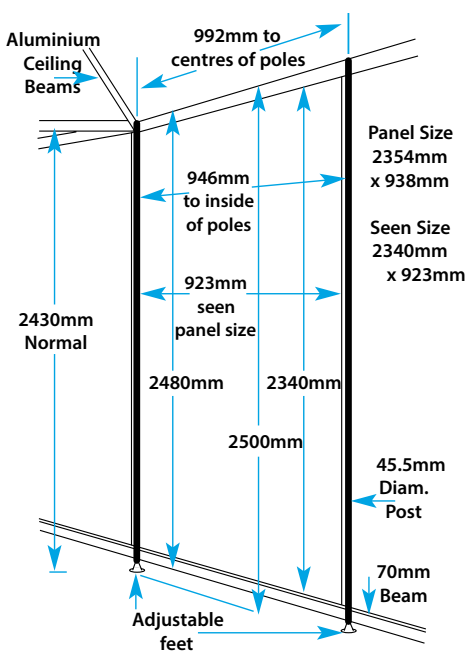

POST SECTION

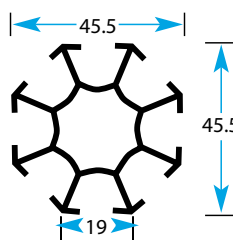

BEAM SECTION

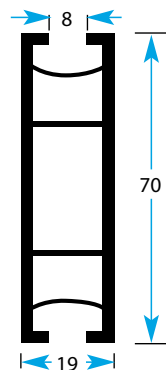

* Cross section

POSTERS & PANELS

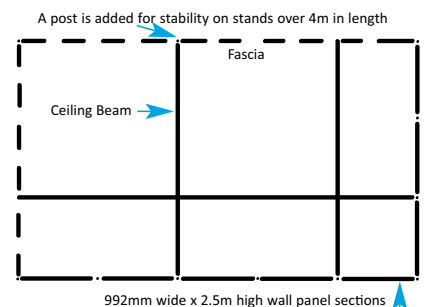
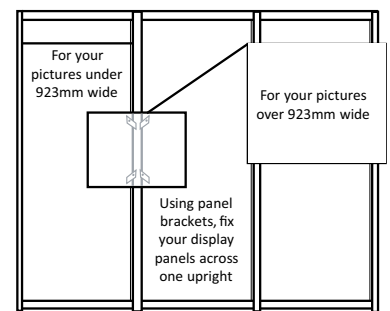

DO'S & DON'TS

We hope you find your shell scheme in order. Please observe the do's and don'ts associated with this system.

The use of the fixings below is strictly forbidden on this system:



FIXING IS PERMITTED BY:

Melamine/Vinyl Panels

- Double sided tabs
- Velcro hook and loop
- Panel brackets
- Hanging chains for heavy exhibits

Loop Nylon Panels

- Velcro hook
- Panel brackets
- Hanging chains for heavy exhibits

GES approved d/s pads and Velcro tape only to be used (available for sale at the front of the halls at the Service Desk)

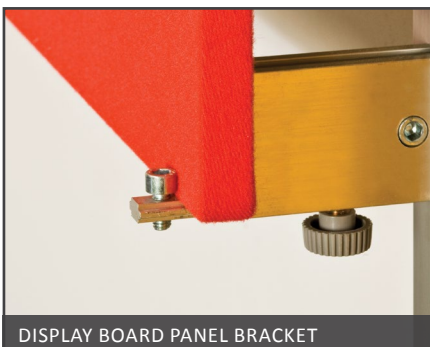

DISPLAY BOARD PANEL BRACKET



SODEM SHELL SCHEME BRACKET

FAQ

Q. I missed the deadline date on the order forms; will there be a charge?

A. Deadlines are shown to encourage exhibitors to reply early. Surcharges will be applied to electrical orders only after this date (except late exhibitors). Furniture orders should be made as early as possible due to stock levels. Place any other orders (name panels, shell scheme extras, etc) as soon as possible.

Q. Do I have to have the Fascia and Grid Ceiling?

A. No. Please contact our ServiCentre if you would like them to be removed, however if a wall is over 4000mm in length and doesn't back onto another shell scheme, bracing may be needed for stability. Please note on certain events this is subject to event organisers approval.

Q. What do I need to order to create a storage area in the corner of my stand?

A. To create a 1000mm wide x 1000mm deep store you will need to select at least 1 x wall panel (WP) and 1 x Lockable Door Section (EWD) or Entrance Way Curtain (EWC) on the order form (shell scheme only). This depends on the number of open sides you have.

Q. If I want to change the colour of the wall panels, what are the options?

A. Shell scheme walls are usually white PVC but there is the option of covering the panel with Display Loop Nylon (Velcro Compatible) or Vinyl Covering on one side before the panel is set into the framework.

Q. How do I calculate how many panels I have on my stand?

A. Shell scheme walling is made up of 1000mm wide x 2500mm high sections. Therefore, if your stand has a back and sidewall (a corner plot) and the stand size is 4000mm x 4000mm you have 8 panels.

Q. I would like to cover the shell scheme panel with my own graphics, what is the size of the wall panel?

A. The visible panel size is 923mm wide x 2340mm high.

Q. What is the visible size of half a metre wide panel?

A. The visible area is 428mm wide x 2340mm high.

Q. I have lightweight posters or pictures, how do I fix these to the wall panels?

A. Velcro or sticky pads are the best options, (blue-tack doesn't work) these can be purchased from our Service Desk during the exhibition.

Q. I have heavy panels, how do I fix these to the shell scheme?

A. Under 992mm wide: using brackets fixed into the upright grooves across 1 support pole, or hook and chain. Over 1000mm wide: using brackets fixed into the upright grooves across 2 support poles. Panel brackets are available from our Service Desk during the exhibition.

Q. I would like to drape the interior of the shell scheme with a material such as muslin, how do I attach this?

A. You will need to order muslin batten, we will then fix this onto the top of the framework - this can then be stapled to.

Q. I would like to clad the interior of the shell scheme with foam board/ chipboard, how do I calculate the measurements?

A. Please call our ServiCentre if you require assistance. Alternatively, you can order chipboard from us for which the charges include installation.

Q. I would like to change the colour of the carpet, what are the options?

A. You can change the colour of the carpet to another colour in the same range for a small charge (providing we are the contractor) please contact our ServiCentre.

Q. I cannot find exactly what I am looking for, do you hire out any other items?

A. Please contact the ServiCentre with any requests and we will try our best to meet your requirements.

To order visit ordering.ges.com (select GES UK from the drop down) or call our ServiCentre on +44 (0)2476 380 183

Please note: All measurements are in millimetres DIA = diameter D = depth H = height W = width SH = seat height L = length
These images are examples only, your shell scheme may vary



COMPLETE SHELL SCHEME FOR EXHIBITIONS AND EVENTS

