

**MITSA**  **ALLOY**  
EXPLORE WITH NO LIMITS

# 2024 BROCHURE



# CONTENTS

## INTRODUCTION

ABOUT MITS  
PICKING YOUR SETUP  
OUR RELIABLE NETWORK

## TRAYS

STANDARD INCLUSIONS & OPTIONS  
DUAL CAB TRAYS  
EXTRA CAB TRAYS  
SINGLE CAB TRAYS  
AMERICAN TRAYS

## CANOPIES

STANDARD INCLUSIONS & OPTIONS  
DUAL CAB CANOPIES  
EXTRA CAB CANOPIES  
SINGLE CAB CANOPIES  
AMERICAN CANOPIES  
CANOPY ACCESSORIES  
CANOPY INTERNAL LAYOUT OPTIONS  
12V SYSTEMS

## CONTACT US

GET A QUOTE



# ABOUT MITS

MITS Alloy was born from the ever-increasing amount of requests that were received for quality trays, canopies, toolboxes and service bodies that could stand up to the harsh abuse of work and mine sites. Over the last 5 years, the 'shed' has grown from a small single bay to spanning across multiple locations and a dozen buildings to incorporate linear production strategies and introduce advanced manufacturing techniques and procedures. MITS Alloy manages everything from powder coating to 12V installations, in-house. In 2020, MITS Alloy gained certified status as an Australian made product.

Throughout this expansion, product line refinements and extensive R&D programs that covered hundreds of thousands of kilometres means continual improvement across our product offerings. This real-world testing leads to innovative features not seen anywhere else in the sector and places MITS Alloy at the forefront of the tray and canopy market.

Partnerships with local material and hardware suppliers has supported local industry and jobs, and key alignments with other premium aftermarket accessory suppliers means the optional extras we supply are of the same quality that MITS Alloy customers expect.

Helping our customers realize their dream utility vehicle for work, play, or both, has become a reality for MITS Alloy not only here in Australia, but also in locations around the globe, including North America and New Zealand. Whether it is during the initial consultation stage, production of your new tray and canopy, handing over your pride and joy or listening to feedback and ideas in our after-sales support team, every MITS Alloy employee is as passionate as you about exploration and off road adventure. We are here to help you get the most out of your investment in your vehicle.



## EXPLORE WITH NO LIMITS!

# OUR NATIONWIDE NETWORK

Looking to make yours a MITS, but are not located around our showrooms in Newcastle, NSW or Brendale, QLD? We have dealers all over Australia to make sure you're able to get your hands on a MITS Alloy tray and canopy. Our packages are built in our headquarters and shipped to your selected dealer of ours, where they install the package. This means you get our lifetime manufacturers warranty and a simple process where all you have to do is drop the vehicle off and pick it up later!

Have all your 4WD gear fitted at the one place, so you can get our enjoying the wide open road quicker and easier. Explore with no limits!



**VISIT ONE OF OUR  
SHOWROOMS OR A  
MITS STOCKIST  
TODAY**



## MITS ALLOY NEWCASTLE

121 WOODSTOCK ST,  
MAYFIELD NORTH NSW 2304

## MITS ALLOY BRENDALE

1/55 DOHERTY ST,  
BRENDALE QLD 4500



**SCAN OR TAP QR CODE TO FIND YOUR LOCAL DEALER.**



# HOW TO PICK YOUR SETUP

We have made our products **modular**, so you don't have to be locked in to the same setup forever! The three steps below will ensure you get everything you need, and if you can't decide, that's ok because we can add to your epic setup at a later stage. Our range is also **compatible with other brands**, so reach out if you want particular products in your build.

<p><b>1</b></p> <p><b>PICK YOUR TRAY</b></p>	<p><b>2</b></p> <p><b>CHOOSE YOUR CANOPY SETUP</b></p>	<p><b>3</b></p> <p><b>DECIDE ON INTERNAL LAYOUT</b></p>
<p>First we start with your base! Manufactured from heavy-duty aluminium and built to handle the rigors of harsh everyday use, our trays are built to last a lifetime and make for the perfect base to build your dream package.</p>	<p>The canopy is where the customisation begins! We have a range of sizes, dependent on your vehicle use. Made from tough aluminium and created for flexibility when it comes to the layout of your vehicle, the possibilities are endless.</p>	<p>Now it's all about what you carry. Build an internal layout to suit your requirements and make it a dream to work and play from! The modular design means that you can change your layout when you need to.</p>



## THE MITS ALLOY UNIQUE UNISTRUT SYSTEM

### WHAT DOES THIS MEAN?

Simply, all of our internal accessories are bolt-in, meaning you can remove them quickly and easily with a 13mm socket should you need more space in your canopy or if your daily operation changes.

Not sure what you want? That's fine! Because all of our accessories bolt into our canopies, you can do the internal fit-out later on!



UNISTRUT SYSTEM INSIDE CANOPY



# TRAYS

## STANDARD INCLUSIONS & OPTIONS

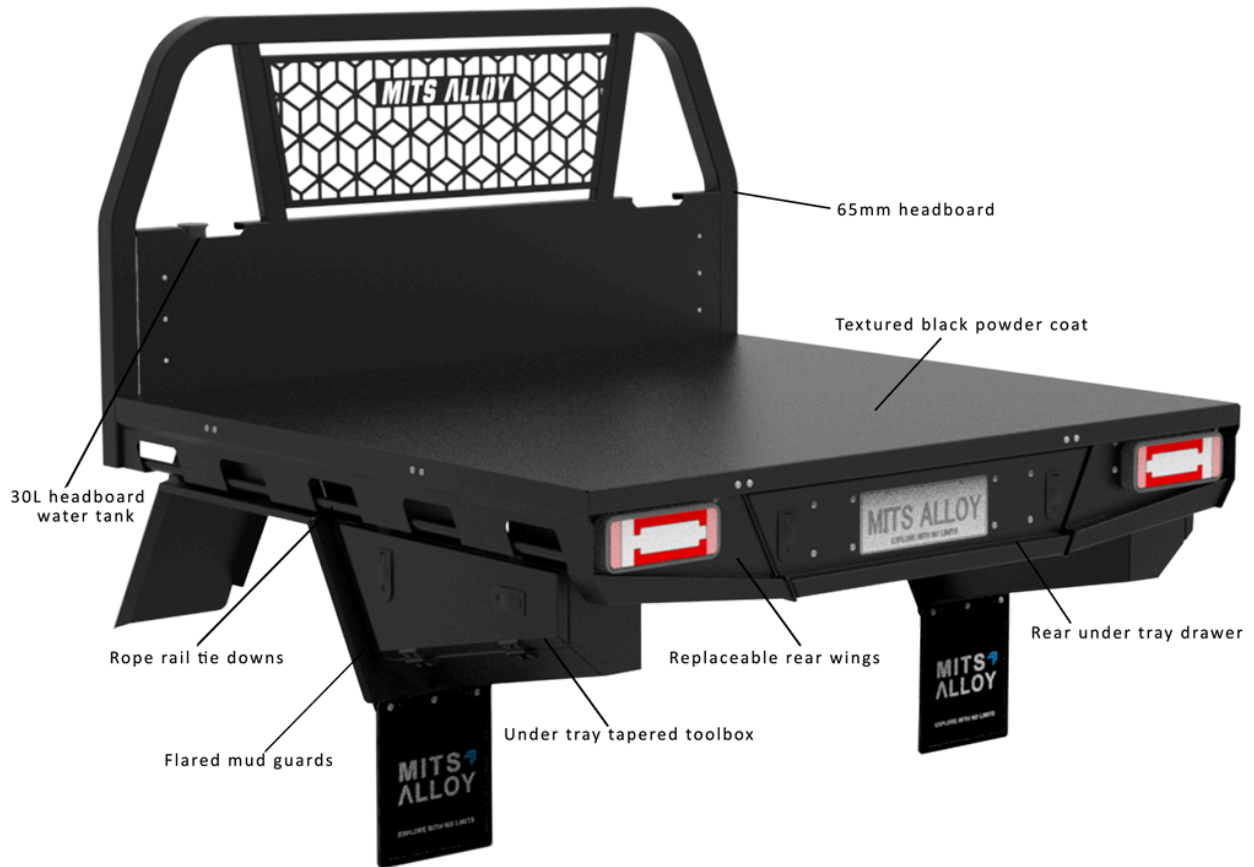

**ALL MITS ALLOY TRAYS COME WITH STANDARD INCLUSIONS.**

- 65MM HEADBOARD
- TEXTURED BLACK POWDER COAT
- REAR UNDER TRAY DRAWER
- REPLACEABLE REAR WINGS
- UNDER TRAY TAPERED TOOLBOX
- FLARED MUD GUARDS
- ROPE RAIL TIE DOWNS
- 30L HEADBOARD WATER TANK



# TRAYS

## OPTIONAL EXTRAS

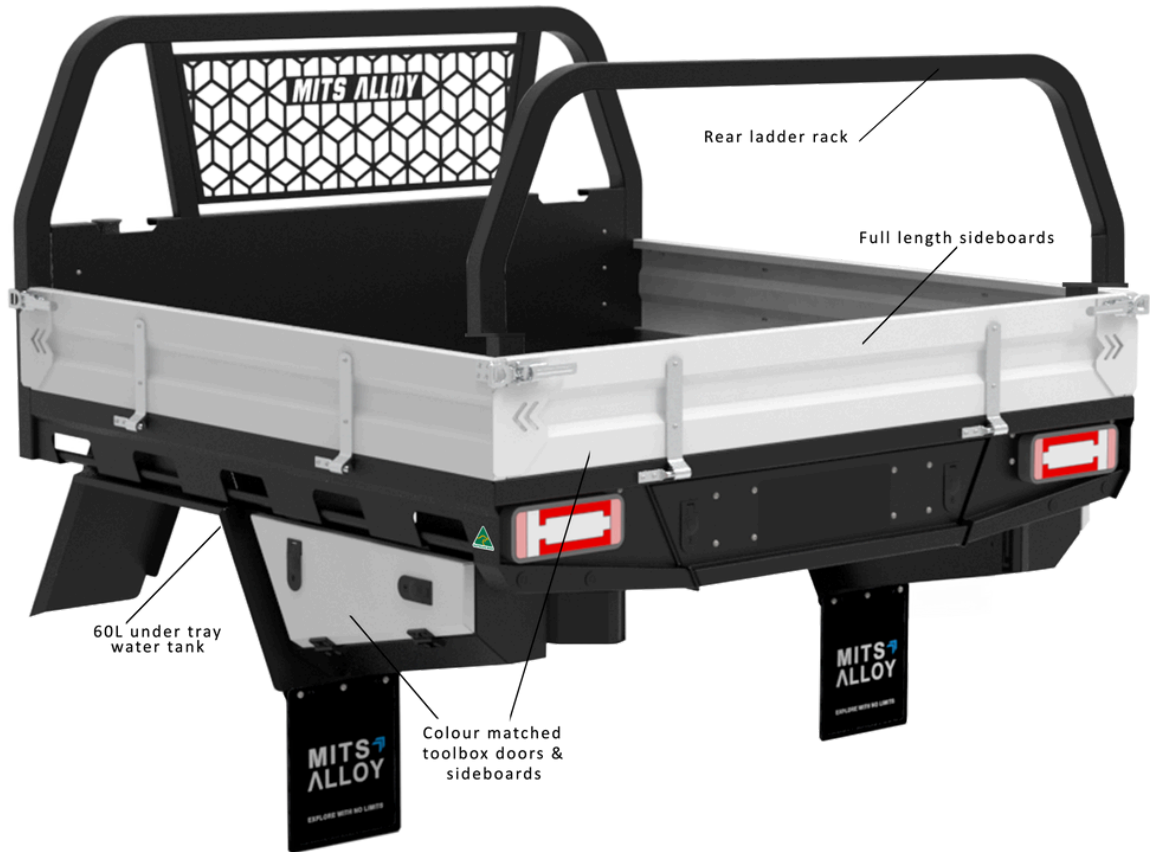

LOOKING FOR ADDITIONAL FEATURES?  
WE HAVE SOME OPTIONAL EXTRAS YOU MIGHT LIKE!

---

REAR LADDER RACK  
FULL LENGTH SIDEBOARDS  
COLOUR MATCHING ON YOUR TOOLBOX DOORS & SIDEBOARDS  
60L UNDER TRAY WATER TANK



# TRAYS



USE THE TABLE BELOW TO FIND YOUR TRAY!

TRAY SIZE	WEIGHT	CAB	VEHICLE
1765(L) 1870(W) 850(H)	227kg	DUAL CAB	HiLux, Ranger, D-MAX, BT-50, Triton, Colorado, Navara, Gladiator, Amarok (2023 on) & 79 Series.
2050(L) 1870(W) 850(H)	253kg	EXTRA CAB	HiLux, Ranger, D-MAX, BT-50, Triton, Colorado, Navara & 79 Series (300mm ext).
2415(L) 1870 (W) 850(H)	278kg	SINGLE CAB	HiLux, Ranger, D-MAX, BT-50, Triton, Colorado, Navara & 79 Series.
1765(L) 1870(W) 850(H)	227KG	MID SIZE SWB	Tacoma, Ranger, Colorado, Gladiator.
2050(L) 1870(W) 850(H)	254KG	MID SIZE LWB	Tacoma, Ranger, Colorado, Gladiator.
2000(L) 2050(W)	269kg	6.4FT USA	RAM 1500, F-150, Silverado/GMC 1500.
2200(L) 2050(W)	283kg	7FT USA	RAM 2500/3500, F-250.
2500(L) 2050(W)	307kg	8FT USA	F-350, Silverado/GMC 2500/3500.

FEATURES: 30L HEADBOARD WATER TANK | 1500MM REAR UNDER TRAY DRAWER | FLARED MUDGUARDS | REAR UNDER TRAY TOOLBOXES | TEXTURED BLACK POWDER COAT | INSTALLATION INCLUDED | LIFETIME MANUFACTURING WARRANTY | FACTORY CAMERA/SENSOR RELOCATING INCLUDED | FREIGHT PRICED SEPARATELY IF REQUIRED | 60L UNDER TRAY WATER TANK AVAILABLE | 79 SERIES HEADBOARD HEIGHT 960MM WHERE APPLICABLE.





# CANOPY

## STANDARD INCLUSIONS

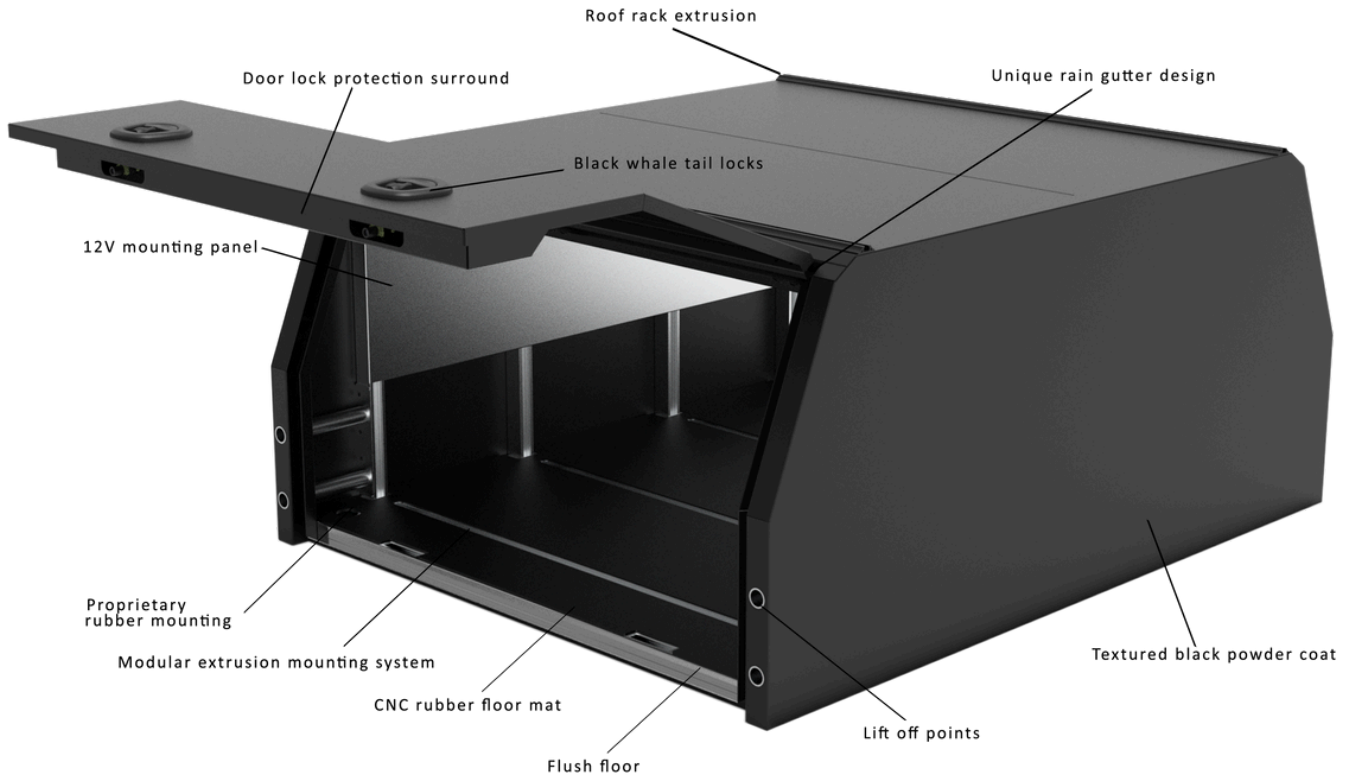

**ALL MITS ALLOY CANOPIES COME  
WITH STANDARD INCLUSIONS.**

ROOF RACK EXTRUSION  
UNIQUE RAIN GUTTER DESIGN  
TEXTURED BLACK POWDER COAT  
LIFT OFF POINTS  
FLUSH FLOOR  
CNC RUBBER FLOOR MAT  
MODULAR EXTRUSION MOUNTING SYSTEM  
PROPRIETARY RUBBER MOUNTING  
12V MOUNTING PANEL  
DOOR LOCK PROTECTION SURROUND  
BLACK WHALE TAIL LOCKS



# CANOPY OPTIONAL EXTRAS

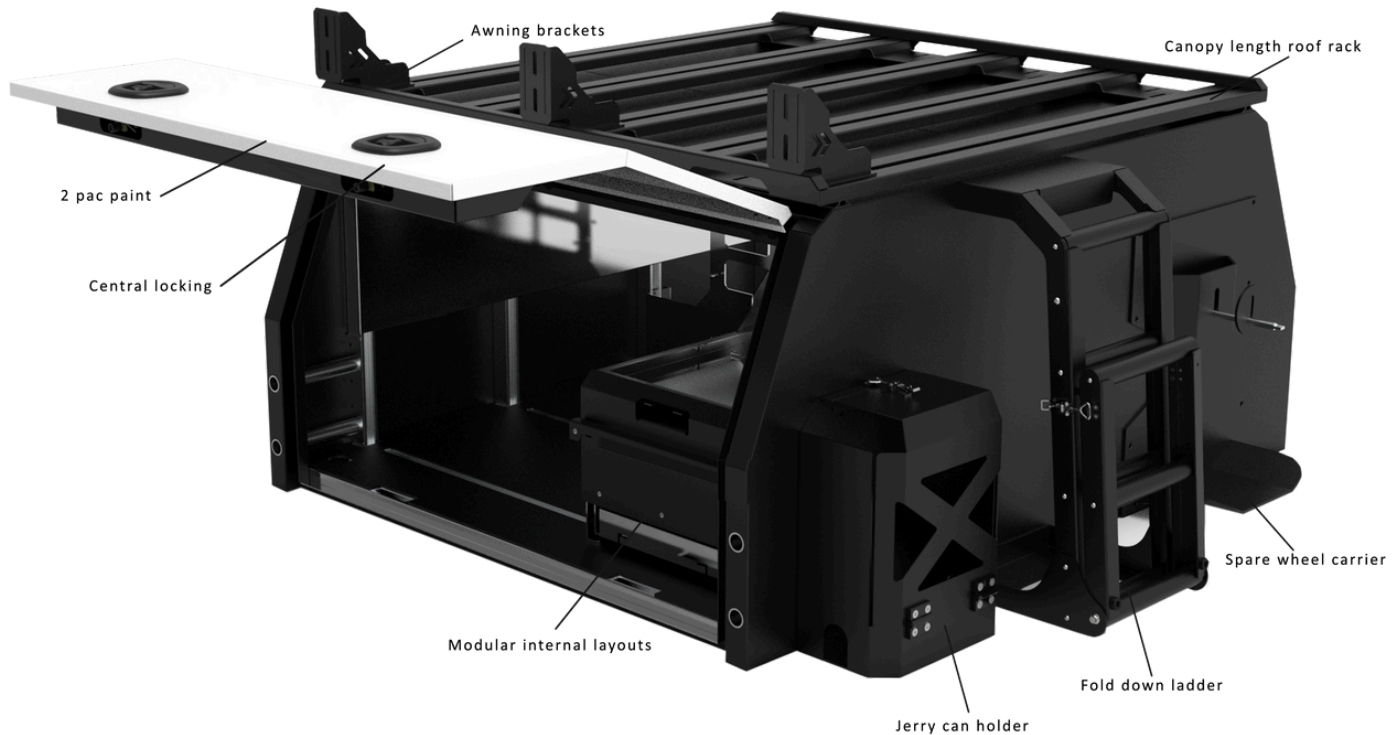

## OPTIONAL EXTRAS YOU CAN ADD TO YOUR MITS ALLOY SETUP

CANOPY LENGTH ROOF RACK  
SPARE WHEEL CARRIER  
FLOD DOWN LADDER  
JERRY CAN HOLDER  
MODULAR INTERNAL LAYOUTS  
CENTRAL LOCKING  
2-PAC PAINT  
AWNING BRACKETS



# CANOPIES



USE THE TABLE BELOW TO FIND YOUR CANOPY!

CAB	VEHICLE	CANOPY SIZES AVAILABLE	CANOPY WEIGHTS
DUAL CAB	HiLux, Ranger, D-MAX, BT-50, Triton, Colorado, Navara, Gladiator, Amarok (2023 on only) & 79 Series.	1000MM, 1320MM 1500MM, 1700MM	122KG, 136KG 160KG, 178KG
EXTRA CAB	HiLux, Ranger, D-MAX, BT-50, Triton, Colorado, Navara, Gladiator, Amarok (2023 on only) & 79 Series.	1000MM, 1320MM 1500MM, 1700MM 1985MM	122KG, 147KG 160KG, 178KG 185KG
SINGLE CAB	HiLux, Ranger, D-MAX, BT-50, Triton, Colorado, Navara, Gladiator, Amarok (2023 on only) & 79 Series.	1000MM, 1320MM 1500MM, 1700MM 1985MM, 2350MM	122KG, 144KG 160KG, 178KG 185KG, 197KG
USA TO SUIT 6FT TRAY	RAM 1500, F-150, Silverado/GMC 1500.	3FT, 4FT 5FT, 5.7FT 6FT	140KG, **KG 178KG, 198KG, 205KG
USA TO SUIT 7FT TRAY	RAM 2500/3500, F-250, Silverado/GMC 2500.	3FT, 4FT 5FT, 5.7FT 6FT, 7FT	140KG, **KG 178KG, 198KG, 205KG, 212KG
USA TO SUIT 8FT TRAY	F-350, Silverado/GMC 3500.	3FT, 4FT 5FT, 5.7FT 6FT, 7FT 8FT	140KG, **KG 178KG, 198KG, 205KG, 212KG 220KG

FEATURES: TEXTURED BLACK POWDER COAT | INSTALLATION INCLUDED | LIFETIME MANUFACTURING WARRANTY | FREIGHT PRICED SEPARATELY IF REQUIRED |



# CANOPY ACCESSORIES



## UPRIGHT PANTRY

BOLT IN UPRIGHT PANTRY  
WEIGHT: 18KG



## FOLD DOWN LADDER

BOLT IN, FOLD DOWN  
WEIGHT: 8KG



## SPARE WHEEL CARRIER

35INCH BOLT IN (37INCH ALSO AVAILABLE)  
WEIGHT: 7.5KG



## JERRY CAN HOLDER

BOLT IN, LOCKABLE, SUITS 20L  
WEIGHT: 6.5KG



## CANOPY LENGTH ROOF RACK

HEIGHT: 55 INTERNAL WIDTH: 1440  
WEIGHT: 18KG+

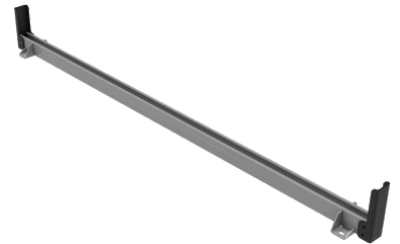

## MULTI RACK

FOR EASY ROOFTOP TENT MOUNTING  
WEIGHT: 3KG+



## AWNING BRACKETS

BOLT IN AWNING BRACKET  
WEIGHT: 0.5KG



## DROP SHELF

BOLT IN. AVAILABLE IN 3 SIZES  
WEIGHT: 600 - 6.9KG, 900 - 8.1KG,  
1200 - 9.4KG



## EVO DRAWER

BOLT IN FRIDGE DRAWER  
WEIGHT: 28KG  
FRIDGE DRAWER MOUNT: 11.2KG



# CANOPY ACCESSORIES



## TRADIE SHELVES

BOLT IN SHELVES  
WEIGHT: 25.8KG



## TRADIE DRAWERS

BOLT IN DRAWERS  
WEIGHT: 51KG



## TRADIE DRAWER & TABLE

BOLT IN  
WEIGHT: 58KG



## SHOWER TENT BRACKETS

WEIGHT: 7.3KG



## AIR FRYER BRACKET

2.93KG MOUNT  
+ 8.5KG AIR FRYER



## LIGHTING

A RANGE OF WORK LIGHTS  
AND MINE BAR PACKAGES.



## ECOXGEAR SE18

SOUNDEXTREME ELITE 300W IP66  
WATERPROOF, DUST PROOF  
INTEGRATED WITH ECOCAST AND  
LEDCAST  
LIGHTING CONTROL WITH THE  
SOUNDEXTREME APP.  
SIZE: 430MM (W), 114MM (H), 114MM (D)  
WEIGHT: 3.63KG



## ECOXGEAR SE26

SOUNDEXTREME POWERSPORTS  
500W IP66 WATERPROOF, DUST  
PROOF INTEGRATED WITH ECOCAST  
AND LEDCAST  
LIGHTING CONTROL WITH THE  
SOUNDEXTREME APP.  
SIZE: 648MM (W), 114MM (H), 114MM (D)  
WEIGHT: 4.8KG



## ECOXGEAR SE28

SOUNDEXTREME ELITE 500W IP66  
WATERPROOF, DUST PROOF  
INTEGRATED WITH ECOCAST AND  
LEDCAST  
LIGHTING CONTROL WITH THE  
SOUNDEXTREME APP.  
SIZE: 696MM (W), 114MM (H), 114MM (D)  
WEIGHT: 4.98KG



# CANOPY INTERNAL SETUP



## P1 - BASIC

UPRIGHT FRIDGE CAGE  
WEIGHT: 10KG

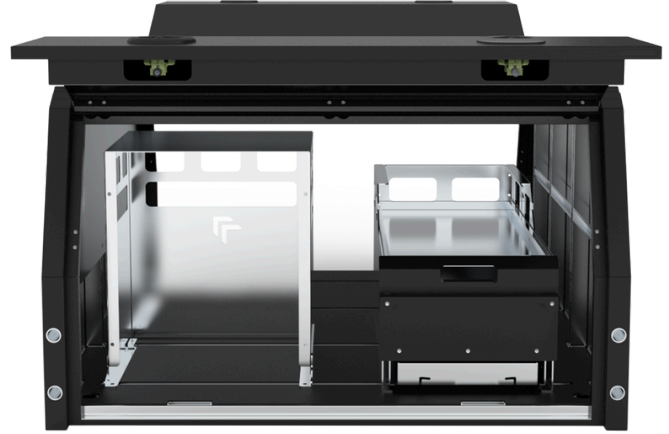

## P2 - WEEKENDER

UPRIGHT FRIDGE CAGE,  
SINGLE DRAWER & TABLE  
WEIGHT: 45KG

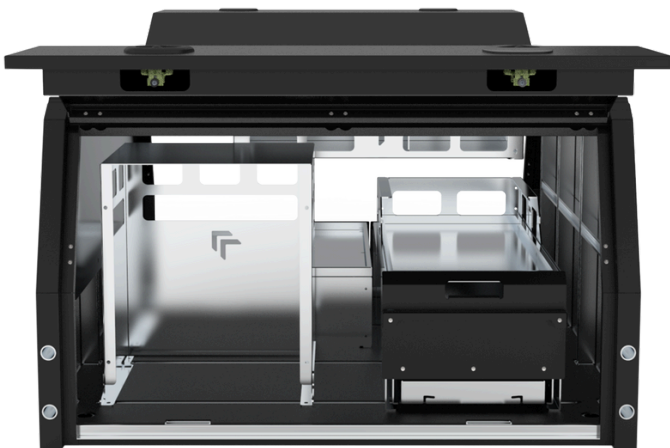

## P3 - ADVENTURER

UPRIGHT FRIDGE CAGE,  
SINGLE DRAWER & TABLE, DROP SHELF  
WEIGHT: 62KG



## P4 - EXPLORER

UPRIGHT FRIDGE CAGE,  
SINGLE DRAWER & TABLE, DROP SHELF,  
SIDE BY SIDE DRAWER SYSTEM  
WEIGHT: 100KG



# CANOPY INTERNAL SETUP

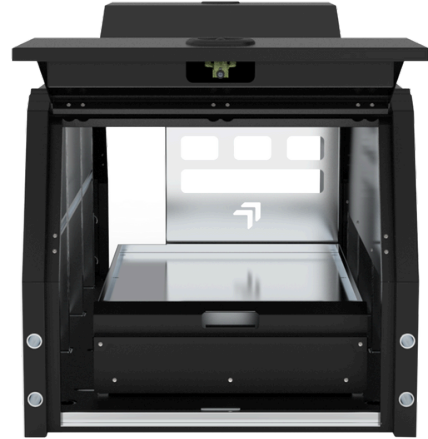

## DOG BOX LAYOUT

A LAYOUT TO TRANSPORT  
YOUR BEST MATE.  
WEIGHT:

## HALF CANOPY LAYOUT

FRIDGE SURROUND,  
SINGLE DRAWER  
WEIGHT: 30KG







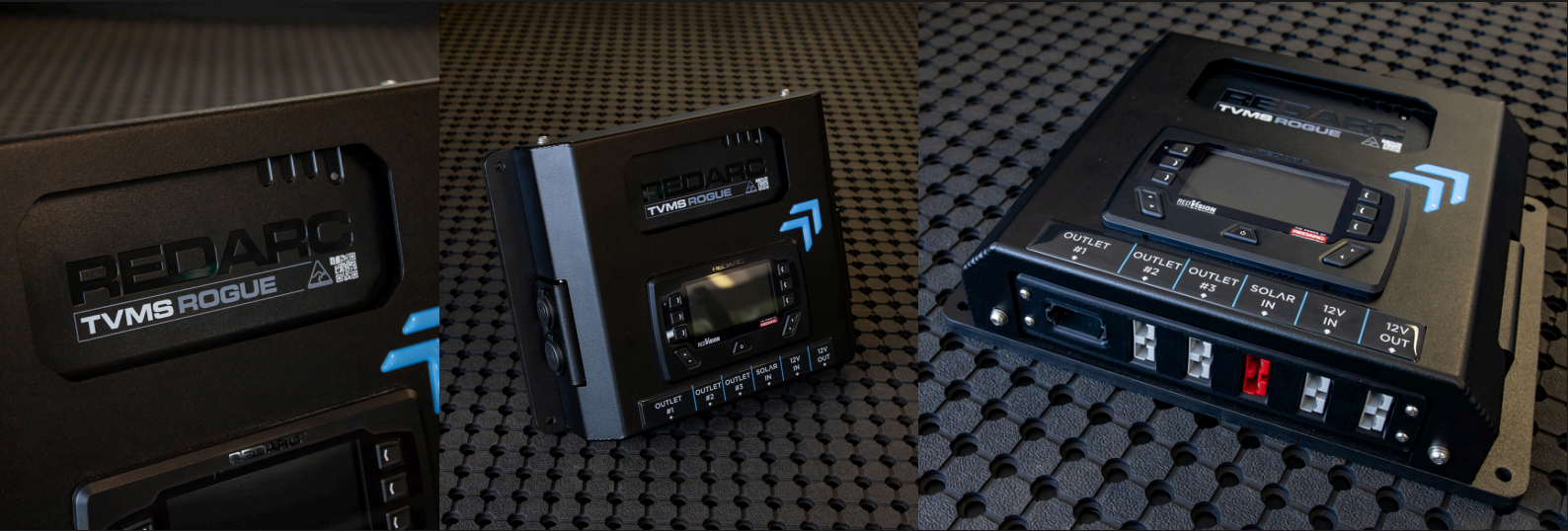

# COMPACT POWER HUB



TVMS ROGUE CONTROL MODULE | REDVISION DISPLAY | BCDC CORE 40A DC BATTERY CHARGER | SMART BATTERY MONITOR | POWDER COATED TEXTURE BLACK | PLASTIC BACKING PLATE | 4 POINT SURFACE MOUNTED | 10 OUTPUTS | TWIN USB OUTLET | CIG SOCKET OUTLET | 2 ANDERSON OUTLETS | 6 PIN DEUTSCH PLUG | ANDERSON PLUG FOR SOLAR INPUT | ANDERSON PLUGS FOR 12V IN AND 12V OUT

## WHY YOU NEED IT:

-  **COMPACT BUT POWERFUL:** THE PERFECT OPTION FOR WHEN YOU NEED POWER FROM YOUR WAGON, BEHIND SEATS, TOOLBOX, CARAVAN OR CAMPER TRAILER.
-  **VERSATILITY AT ITS BEST:** MULTIPLE PORT OPTIONS INCLUDING USB, CIGARETTE SOCKET AND ANDERSON PLUGS, SO YOU CAN POWER ALL YOUR LIGHTING AND ACCESSORIES - FOR WORK AND PLAY!
-  **COMPATIBLE WITH REVISION APP:** WITH THE APP YOU CAN CONFIGURE AND ACCESS EVERYTHING CONVENIENTLY FROM YOUR PHONE.
-  **MADE TOUGH:** CREATED TO WITHSTAND THE RIGOURS OF DAILY USE. A POWER HUB THAT YOU CAN RELY ON!



ASK US ABOUT OUR OPTIONAL  
ACCESSORIES (SOLD SEPARATELY)





# 12V SYSTEMS



REDARC ULTIMATE



REDARC ELITE



- TVMS ROGUE WITH REDVISION DISPLAY
- MANAGER ALPHA50 BATTERY MANAGEMENT SYSTEM
- 1 X ALPHA150 12V LITHIUM BATTERY
- 2000W 12V RS3 PURE SINE WAVE INVERTER
- 1 X 180W MONOCRYSTALLINE SOLAR PANEL
- HARDKORR TRI-COLOUR LED CAMP LIGHTS
- DUAL CIG/USB SOCKETS
- FRIDGE ANDERSON PLUG

- TVMS ROGUE WITH REDVISION DISPLAY
- MANAGER ALPHA75 BATTERY MANAGEMENT SYSTEM
- 2 X ALPHA150 12V LITHIUM BATTERY
- 3000W 12V RS3 PURE SINE WAVE INVERTER
- 2 X 180W MONOCRYSTALLINE SOLAR PANEL
- HARDKORR TRI-COLOUR LED CAMP LIGHTS
- DUAL CIG/USB SOCKETS
- FRIDGE ANDERSON PLUG

# SCAN OR TAP TO GET YOUR QUOTE



 [mitsalloy.com.au](https://mitsalloy.com.au)

 [info@mitsalloy.com.au](mailto:info@mitsalloy.com.au)

 1300 006 487

**PLEASE NOTE:**  
MITS CANOPIES AREN'T AVAILABLE FOR SALE SEPARATELY UNLESS YOU  
ALREADY HAVE A MITS TRAY OR YOU ARE PURCHASING BOTH.

**NOT SURE WHAT IS INCLUDED AS STANDARD? CHECK OUT THE VALUE-PACKED  
INCLUSIONS ON OUR TRAYS AND CANOPIES.**

