

MW
www.toolboxmel.com.au
1800 554 434

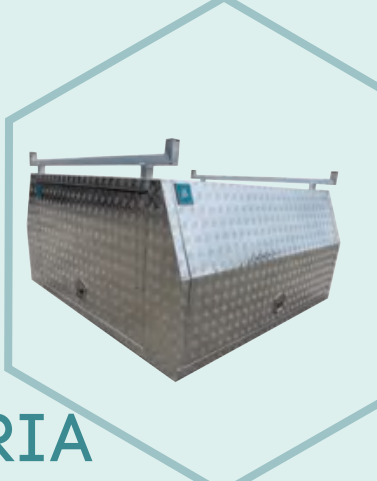
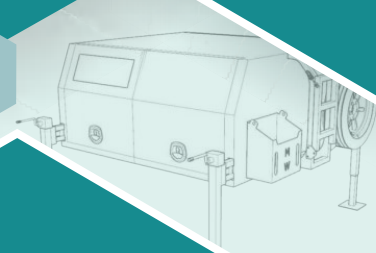
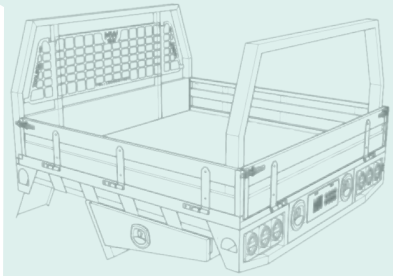
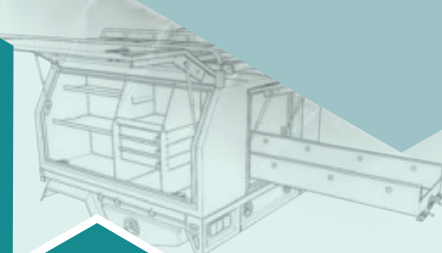

MW VICTORIA CATALOGUE 2021 - 2022

Quality Custom Made for Everyone

CUSTOM BUILD • DESIGN • MANUFACTURE
CANOPIES • TRAYS • TOOLBOXES • TRAILERS

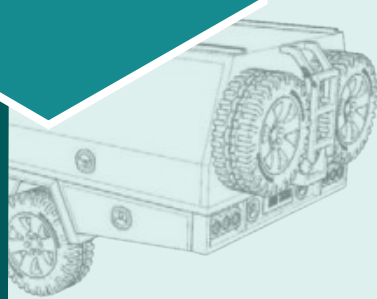

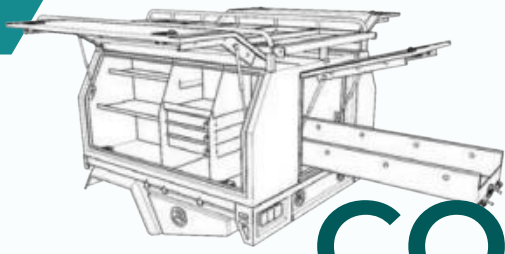

CONTENTS

Service Body	2
Canopy	6
Standard Canopy	6
Custom Tray-mount Canopy	7
Tray	8
Standard Aluminium Tray	8
Custom Built 4x4 Tray	9
Tray & Canopy Package	10
Standard Combo	10
Premium Combo	11
Deluxe Combo	12
Aluminium Tub Canopy	13
Truck Body & Toolboxes	14
Motop® Roof Top Tent V4.0	15
Camper Canopy	17
Standard Toolboxes	19
Accessories	23
Trailer	24
Gallery	25

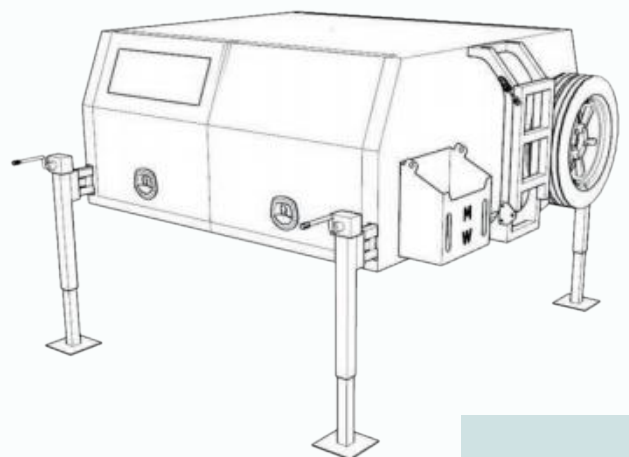
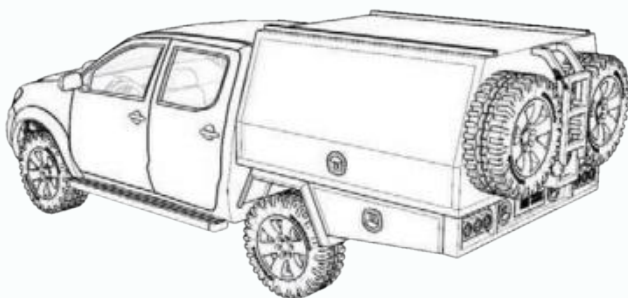



















SERVICE BODY

Direct chassis-mounted full body.
No tray required.



OPTIONS

Material	 Checker Plate 2.5mm 3.0mm	 Flat Plate 3.0mm	
Finish	 Natural	 Powder Coating	 2-pac Painting
Extra Storage	 Under-tray Lockers	 Under-tray Drawer	
Lock	Central locking for canopy (intergrated with vehicle central locking)		
Water Tank	Headboard Tank 40 Litre	Undertray Tank 40/60 Litre	
Roof Racks	 Bar Racks	 Tradesman Rack	 Luggage Rack
Taillights	 Standard LED Lights	 Maxi LED Lights	
Parts	 Jerry Can Holder	 Spare Wheel Holder	 Foldable Rear Ladder
Interior Fit outs	 Dividers & Shelves	 Drawers & Slides	 12V Power System

Make for
Ford Ranger



Make for
Toyota Hilux



Make for
Toyota Landcruiser



Make for
Volkswagen Amarok



Make for
Isuzu Dmax



Make for
Mazda BT-50



Make for
Mitsubishi Triton



Make for
Nissan Navara



Make for
Holden Colorado



Make for
Dodge Ram, Mercedes-Benz and others



CANOPY

Standard or custom-made tray-mount body

Standard Canopy

Fully enclosed aluminium canopy

Checker Plate

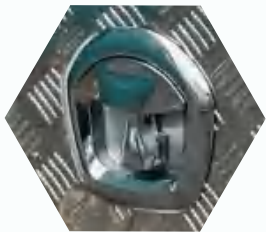

Premium 3-point whale tail lock

Monocoque construction with internal reinforcements



Recessed door with gas struts and rubber seal

Floor with rubber mat



Doors with alarms

Flat Plate

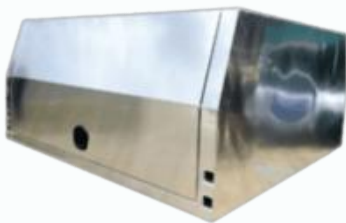









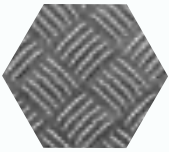
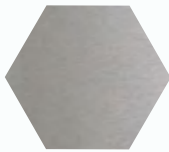

Checker Plate	Length (mm)	Width (mm)	*Height (mm)	Material (mm) Thickness	Bar Roof Racks	Doors
Dual cab	1800	1770	850	2.5	2	3
Extra cab	2100	1770	850	2.5	2	3
Single cab	2400	1770	850	2.5	2	3
Jack-off dual cab	1800	1770	850	2.5	2	3
Flat Plate						
Dual cab	1650	1770	850	2.5	Optional Extra	2
Dual cab	1800	1770	850	2.5	Optional Extra	2

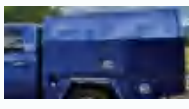
* The height does not include the roof racks

Custom Tray-mount Canopy Build to fit

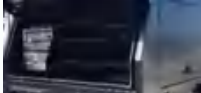
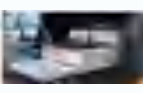

OPTIONS

Material		Checker Plate 2.5mm 3.0mm		Flat Plate 3.0mm		
Finish		Natural		Powder Coating		2-pac Painting
Lock	Central locking for canopy (intergrated with vehicle central locking)					
Roof Racks		Bar Racks		Tradesman Rack		Luggage Rack
Parts	Jerry Can Holder		Spare Wheel Holder		Foldable Rear Ladder	
Interior Fit outs		Dividers & Shelves		Drawers & Slides		12V Power System



TRAY

The most versatile way to maximise the space

Standard Aluminium Tray

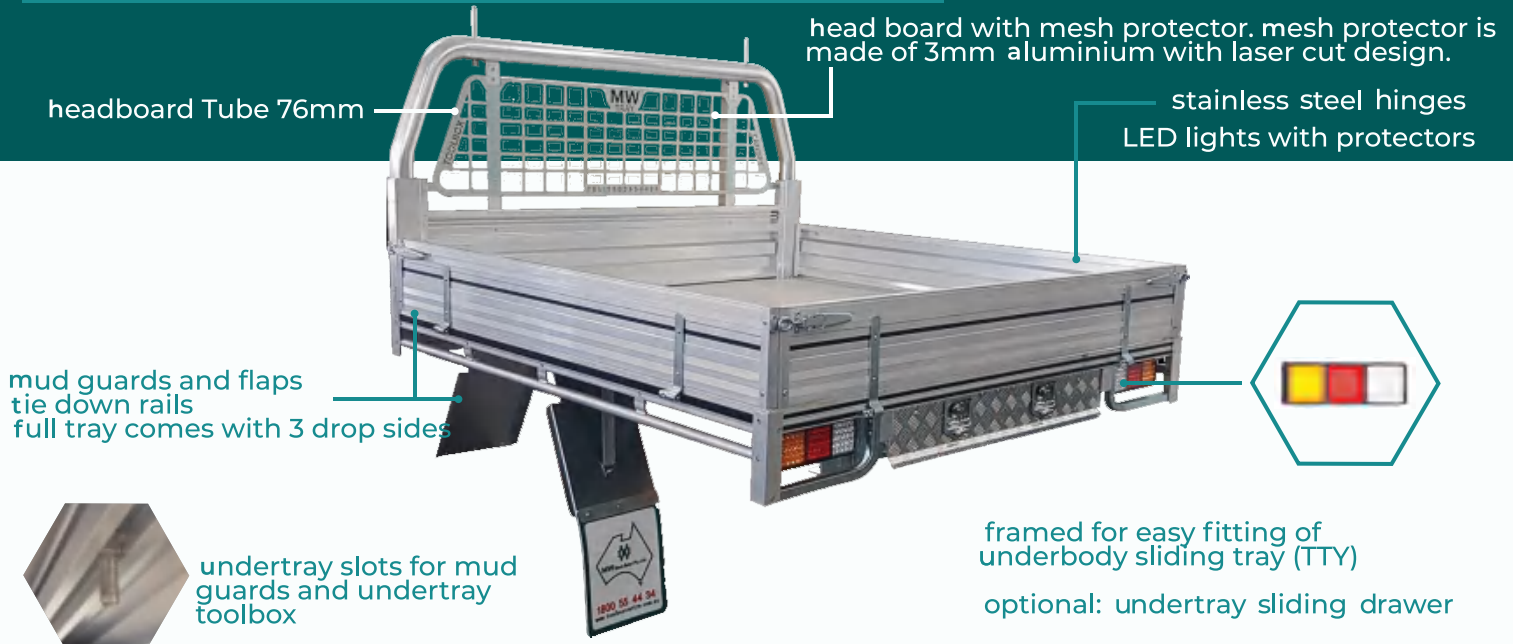

Full Tray



Model	Size (mm)	Weight (kg)
Dual cab	1650L X 1860W	100
Dual cab	1800L X 1860W	115
Extra cab	2100L X 1860W	122
Single cab	2420L X 1860W	135

Tray Deck Only



Model	Size (mm)	Weight (kg)
Dual cab	1650L X 1860W	78
Dual cab	1850L X 1860W	85
Extra cab	2150L X 1860W	100
Single cab	2450L X 1860W	113

Optional Extras



Removable Rear Rack

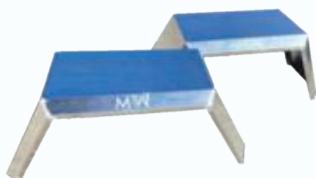

Flared Mud Guards



Checker Plate Under-tray Lockers



Flat Plate Under-tray Lockers



Under-tray Drawer

Custom Built 4x4 Tray



80*50 R.H.S heavy duty headboard with mesh protection

Premium

Full aluminium construction

Fabricated drop-sides with stainless hinges and latches



Laser cut plate mount rope rails

Adventure

OPTIONS

Material

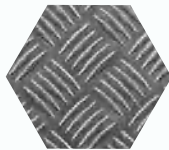

Checker Plate
2.5mm
3.0mm

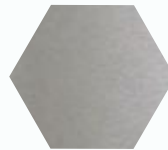

Flat Plate
3.0mm

Finish



Natural
Checker Plate Only



Powder
Coating

Extra Storage



Under-tray
Lockers



Under-tray
Drawer

Taillights



Standard
LED Lights



Maxi
LED Lights

Water Tank

Headboard Tank
40 Litre

Undertray Tank
40/60 Litre

TRAY & CANOPY PACKAGE

Good value with ultimate flexibility

Standard Combo

Standard Tray Deck + Standard Enclosed Canopy



MW Standard Tray Deck

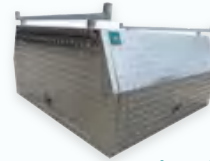

Standard Enclosed Canopy

Standard Full Tray + Standard Jack-off Canopy



MW Standard Full Tray



Standard Jack-off Canopy



Optional Extras



Powder Coating



Roof Rack



Under-tray Lockers



Under-tray Drawer



Premium Combo

Standard Tray Deck + Custom Canopy



MW Standard Tray Deck



Standard Full Tray + Custom Jack Off Canopy



MW Standard Full Tray
(Optional: Power Coating; Flared Mud Guards)



Optional Extras



Powder Coating



Roof Rack



Under-tray Lockers



Under-tray Drawer



Deluxe Combo

Custom 4x4 Tray + Custom Canopy



Premium Tray



Adventure Tray



Full-size Canopy (jack-off)



Half-size Canopy



ALUMINIUM TUB CANOPY

Custom build for great value and style

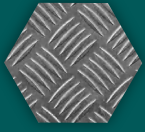

Checker / Flat plate finish



Locking the tailgate

Outstanding security and weatherproofing

Optional Accessories

Lock Central locking for canopy (intergrated with vehicle central locking)

Roof Racks



Bar racks



Custom luggage rack

Tub Drawers



TRUCK BODY & TOOLBOXES

Built to be tough

Built to same height of the cab

Made of 3.0mm checker plate or flat plate aluminium

Strong square tube reinforcement inside

Straight or angled profile design available

Custom drawers and shelving up

Half tray or full tray design



MOTOP[®] ROOF TOP TENT v4.0

Lightest and most compact aluminium hard shell roof top tent



Premium off-centre latches
(pad lockable)

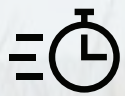

Opens in seconds



- Advanced honeycomb aluminium constructed hard shell with inner insulation liner
- 280GSM poly-cotton waterproof, breathable and tear-resistant canvas
- Stainless gas struts assisted pop-up design with maximum 30kg loading capacity
- Triple point window and entrance with fly screen. Rear entrance with awning
- 2.3m aluminium retractable sliding ladder
- Faux suede self-inflation mattress
- Internal LED lighting with switch and USB port (power in)



Build-in rails for accessories



Large entrance with screen



Ceiling storage pockets

Model	MT-120	MT-135	MT-120 Plus	MT-135 Plus
External dimension (closed mm)	2250L x 1280W x 160H	2250L x 1430W x 160H	2250L x 1280W x 200H	2250L x 1430W x 200H
Weight (kg)	69	73	74	78

Accessories



Awning Brackets (pair)



Down Blanket

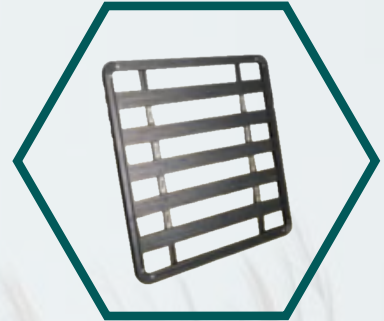

Luggage Rack

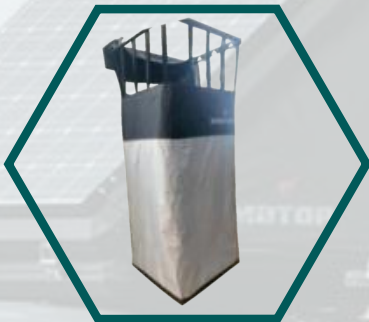

Shower Tent



Solar Panel Roof Racks



Tie-down Rings



CAMPER CANOPY



12V Electrical Control Panel



Electronic Controlled Popup Roof



270 Degree Awning



4 LED Light Strips & 4 Electric Fans



Sitting Area



2200L x 1400W Mattress

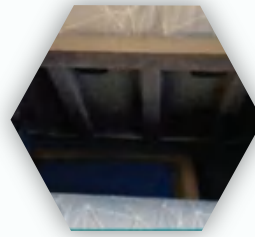

Storage Under Mattress



Cooking station

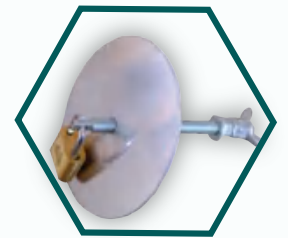

Spare Wheel Carrier

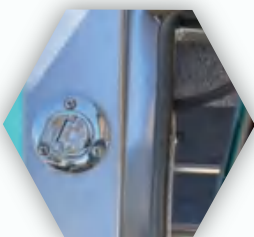

100L Water Tank with Electronic Water Pump



Premium Whale Tail Lock / Central Locking



12V Anderson Plug



Uni Struts Roof Rack

Model	Dual Cab	Extra Cab	Single Cab
Material	2.5mm Flat Aluminium		
Body Length (mm)	1800	2100	2400
Pop Up Total Length (mm)	2800	2800	2800
Body Width (mm)	1800	1800	1800
Body Height (mm)	1050	1050	1050
Pop Up Total Height (mm)	1250	1250	1250
Net Weight (kg)	450	500	550

Accessories



130L Upright Fridge



Cooktop with Sink



Heavy Duty Jack Off Legs



STANDARD TOOLBOXES

Mini Canopy & Dog Cage



Product	Length (mm)	Width (mm)	Height (mm)	Material (checker palte)
Mini Canopy	700	1770	850	2.5mm
Mini Canopy with half dog cage	700	1770	850	2.5mm
Tube & Mesh Dog Cage	700	1770	850	40 alloy RHS
1200mm Canopy	1200	1770	850	2.5mm

**standard canopy/dog cage design may vary due to product enhancement*

F Series Side Opening

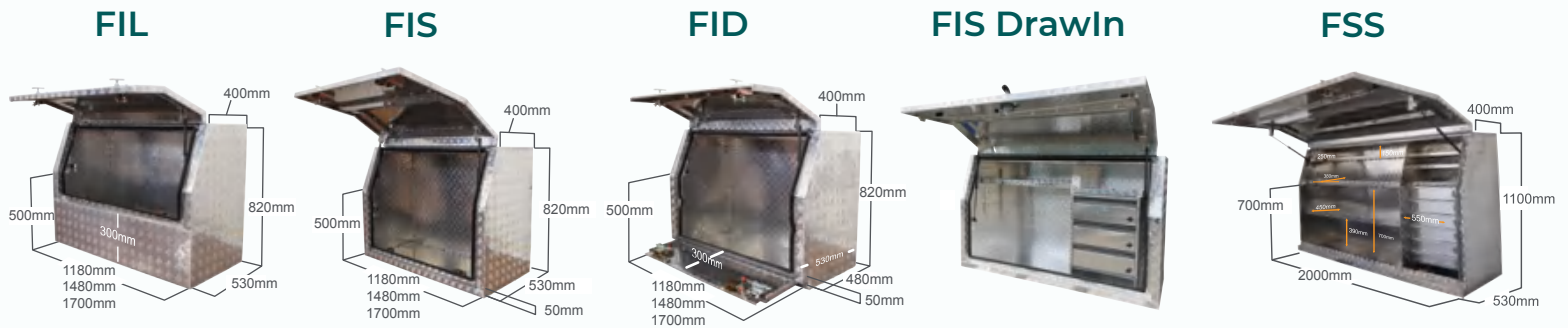

FIC 2 drawers

FIC 3 drawers

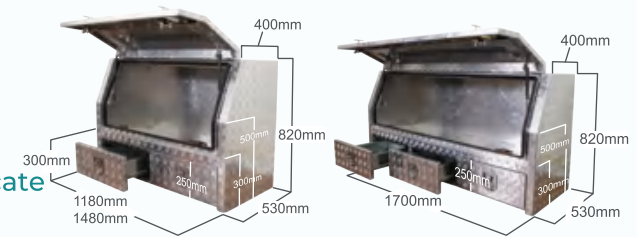

Features

- Lifted lid provides shield from the rain
- Drop down lid makes lifting in and out easy (FID model)
- Storage space created in between a pair of boxes
- Shelves & drawers keep all loose items organised and easy to locate
- Concealed lid and 4-fold frame structure provides top security and water resistance

Model	Length(mm)	Width(mm)	Height(mm)
A-FIL-BTL	1180 / 1480 / 1700	530	820
A-FIS-BTL	1180 / 1480 / 1700	530	820
FIS-DrawIn	1180 / 1480 / 1700	530	820
A-FID-BTL	1180 / 1480 / 1700	530	820
A-FIC-BTL	1180 / 1480 / 1700	530	820
A-FSS-BTL	2000	530	1100
A-FIS-BTL	2100	550	850

ST Series Top Opening

Features

- Wide opening for bulky items
- Larger capacity, accommodate a range of tools
- Low height to ensure clear view of traffic
- Drop-down lid at front (STD) provides easier access for bulky / heavy items
- Perfect for nail guns and drop-saw

STS Top Opening

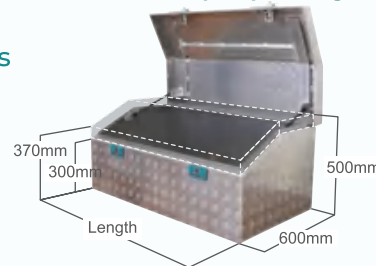

STD Top and Front Opening

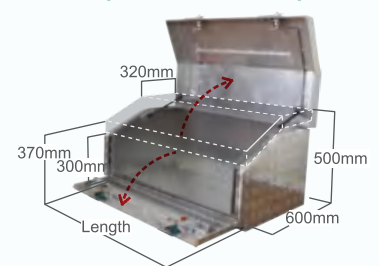

Model	Length(mm)	Width(mm)	Height(mm)
A-STS-BGS	1100 / 1400 / 1730	600	500
A-STD-BGS	1100 / 1400 / 1700	600	500

REC Series Top Opening

A-REC-BCS C-lock

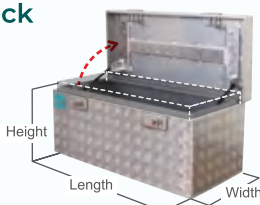

Model	Length(mm)	Width(mm)	Height(mm)
A-REC-BCS	900	400	400
A-REC-BCS	1100	500	420
A-REC-BCS	1400	500	420
A-REC-BCS	1700	550	450
A-REC-BCS	1000	600	600

LJB Site Box

Features

- Reinforcement brace on body provides extra strength
- Heavy gauge material (2.5mm) Aluminium Checker plate or 1.6 mm (Gal steel)
- Heavy duty handles and casters designed for tough building site environment
- Light weight and easy handling



Galvanised steel plate powder coated



Model	Length(mm)	Width(mm)	Height(mm)
A-LJB-BCL	1180	700	750
G-LJB-BCL (Powder Coated)	1160	700	750

TSO Wide Opening

Features

- Wide access for bulky items, such as jackhammers, generators



Opening Style



Model	Length(mm)	Width(mm)	Height(mm)
A-TSO-BTS	1100	500	500
A-TSO-BTL	1400 / 1800	600	700

DB Series Gullwing Box

Features

- Gull-wing lids enable easy access from either side
- Sit across back of tray against cab, providing ample space on tray
- Low height to ensure clear view of traffic
- Balanced weight on tray

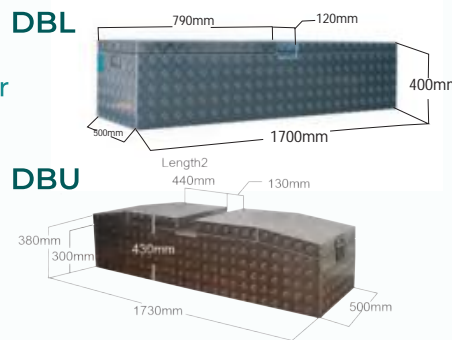

Opening Style



Model	Length1(mm)	Length2(mm)	Width(mm)	Height(mm)
A-DBL-BCS	1700	790	500	400
A-DBU-BGS	1730	440	500	430

UI Series Side Opening

Features

- Storage space created in between a pair of boxes when installed
- Concealed lid and 4-fold frame structure provides top security and water resistance
- Lifted lid provides shield from the rain

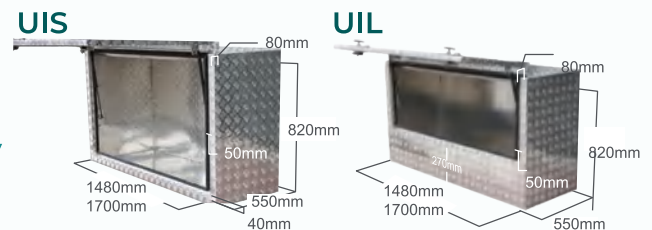

Model	Length(mm)	Width(mm)	Height(mm)
A-UIS-BTL	1480 / 1700	550	820
A-UIL-BTL	1480 / 1700	550	820

ALT In Tub Toolbox

Features

- Suitable for tub trays, pickup utes and can be accommodated in most vehicle models
- Top level with tub can be stored under hard lid/tonneau cover

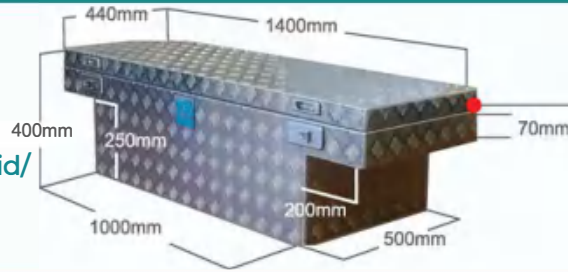

Model	Front / Back Length(mm)	Height1 / Height2(mm)	Top / Bottom Width(mm)
A-ALT-BCS	1400 / 1000	400 / 250	440 / 500

TDB Trailer Drawbar Box

Features

- Matches 4ft/ 5ft wide trailer
- Rear step allows full opening of lid
- Will not interfere with your turning circle

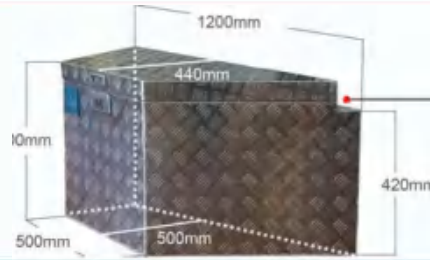

Model	Front / Back Length(mm)	Height1 / Height2(mm)	Top / Bottom Width(mm)
A-TDB-Trailerbox-C	500 / 1200	440 / 500	500 / 420

TTY Under Body Sliding Tray



G-TTY(steel)

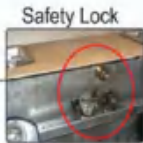

A-TTY (aluminum)

G-TTY (steel)

- Heavy-duty galvanised steel structure for max 100kg spread loading
- Folded drawer core with horizontal and vertical rollers
- MW exclusive heavy-duty whale-tail and safety locks

A-TTY (aluminum)

- Marine grade aluminum construction with 100kg spread loading capacity
- 227 kg rated heavy duty telescopic runners
- MW exclusive heavy-duty whale-tail locks
- 95% slide-out length, maximised accessible distance
- Dual gas struts assisted lid
- Lid has 400mm rebate at its far end, ideal to clear obstacles such as spare wheel on the canopy

Model	Length(mm)	Width(mm)	Height(mm)	Capacity(kg)
G-TTY(Steel)	1700/2100	750	170	100 (Evenly spread load)
A-TTY(Aluminum)	950/1250/1550/1750	750	180	100 (Evenly spread load)

UT Series Under Body Boxes

Features

- Match mudguards (UTS and UTC models)
- Clearance for rope rails
- Great for the storage of smaller items
- UTC has Left and Right angles
- Left angle suites rear passenger side or front driver side
- Right angle suites front passenger side or rear driver side

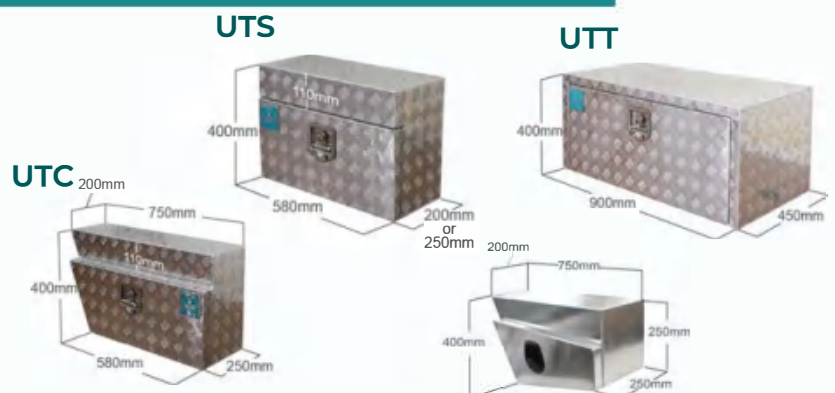

Model	Top Length(mm)	Bottom Length(mm)	Top Width(mm)	Bottom Width(mm)	Height (mm)
A-UTC-LTN / A-UTC-RTN	750	580	200	250	400
A-UTS-BTN	580	580	200 or 250	200 or 250	400
A-UTT-BTN	900	900	450	450	400

*standard boxes design pattern may vary due to product enhancement

Roller Door Toolboxes

Features

- 2.5mm Marine Grade Aluminum Flat Plate 5005 Series.
- Roller door with lock.
- Two adjustable shelves for flexible storage.
- Three size available for all kinds of Ute and trucks.
- Powder coated interior and exterior area.
- Fully Rubber Sealed, Weather Resistant.

Roller Door
(no shelves)



Model	Length(mm)	Width(mm)	Height(mm)	Thickness
Roller Door (no shelves)	2000	600	1200	2.5
Roller Door with shelves	1200 / 1500 / 1800	600	930	2.5

GB Generator Box

Model	A-GBB-TS
Length(mm)	620
Width(mm)	400
Height(mm)	500

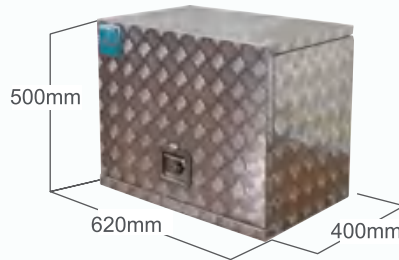

Opening Style



ACCESSORIES

LOCKS



B Lock



C Lock



G Lock



H Lock



T Lock

Whale Tail Lock (Black/Silver)



Available in Manual or Central Locking System

OTHERS

Bottle Holder (A-OBH)



430mm(L)x190mm(W)x300mm(H)

Small Toolbox (A-HDF)



580mm(L)x280mm(W)x200mm(H)

Hand Carry case



660mm(L)x260mm(W)x265mm(H)

OTHERS



Gas Struts



Anchor Point



Catch Fasteners



Spring Loaded



Handle



Vent



Wheels

ALUMINIUM DRAWER

2 Drawers



520mm(L)x420mm(W)x430mm(H)

3 Drawers

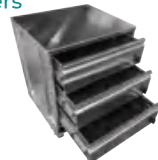

520mm(L)x430mm(W)x580mm(H)

4 Drawers



520mm(L)x430mm(W)x580mm(H)

5 Drawers

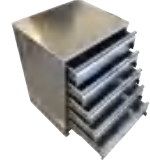

520mm(L)x430mm(W)x700mm(H)

Classic Drawer Slide



550mm(L)x600mm(W)x350mm(H)

"D" Series Drawer Slide



550mm(L)x600mm(W)x350mm(H)

Maxx Drawer Slide



550mm(L)x600mm(W)x300mm(H)

Double D Drawer with Bench



800mm(L)x750mm(W) x 450mm(H)

MATERIALS



A: Aluminium Checker Plate

Thickness: 2.0mm / 2.5mm / 3.0mm



F: Aluminium Flat Plate

Thickness: 2.5mm / 3.0mm



P: Aluminium Propeller Plate







Thickness: 3.0mm



G: Galvanised Steel Plate

Thickness: 1.2mm / 1.6mm

ALLOY TRAILERS

WT-1		WT-2		WT-3		WT-4E	
							
2 doors, fully enclosed		3 doors, fully enclosed		Box Trailer		3 doors, fully enclosed	
WT-5			WT-UTE-D (with 1 drawer and brakes)		WT-UTE (without drawer and brakes)		
							
3 doors, fully enclosed			Toolboxes sections and drawer				
Product Code			Standard Size		Dimension (mm/ft)		
WT-1 / WT-2 / WT-3		Single Axle	1800x1200 6x4	2100x1200 7x4	1800x1500 6x5	2100x1500 7x5	2400x1500 8x5
WT-4E / WT-5		Double Axle					
WT-UTE		Single Axle					
WT-UTE-D		Single Axle					

Standard trailer bodies are made of 2mm thick aluminum checker plate and chassis are hot-deep galvanized.

ALLOY TRAILERS COVERS

TC-1		TC-2		TC-3		TC-4		TC-5		TC-6	
											
200mm high		200mm high		400mm high		200mm high		500mm high		950mm high	
Product Code			Standard Size		Dimension (mm/ft)						
TC-1 / TC-2 / TC-3			1840x1290	2140x1290	1840x1590	2140x1590	2440x1590				
TC-4 / TC-5 / TC-6			6x4	7x4	6x5	7x5	8x5				

Standard thickness 2.0mm (checker plate)



Custom-made Aluminium Trailers



GALLERY

Canopies



Toolboxes



UTE Trays



Truck Boxes



NSW & ACT

NSW Service Centre



St. Peters
 Add: 578 Princes Highway, St. Peters, NSW 2044
 Tel: 02 9519 4714
 Fax: 02 9519 3600



Wollongong
 Add: 8C Flinders Street, Wollongong NSW 2500
 Tel: 02 4200 9029



Ryde
 Add: 121 Church Street, Ryde, NSW 2112
 Tel: 02 9809 0977
 Fax: 02 9519 3600



Canberra
 Add: 155 Newcastle Street, Fyshwick ACT 2609
 Tel: 02 6239 3259



Bankstown
 Add: 99 Canterbury Road, Bankstown, NSW 2200
 Tel: 02 9707 4660
 Fax: 02 9708 0229



Newcastle
 Add: 3/85 Griffiths Road, Lambton, NSW 2299
 Tel: 02 4952 1609
 Fax: 02 9012 0465



Penrith
 Add: 2063 Castleleigh Road, Penrith, NSW 2750
 Tel: 02 4722 8366
 Fax: 02 4722 8399

VIC

VIC Factory Shop



Clayton Shop
 Add: 69-81 Garden Rd, Clayton, VIC 3168
 Tel: 03 9547 7279 / 04 2099 2066



Bulleen
 Add: 12 Manningham Road, Bulleen, VIC 3150
 Tel: 03 9850 3199

VIC Service Centre



Service Centre
 Add: 9-15 Longford Court, Springvale VIC 3171
 Tel: 03 9543 4800



Dandenong
 Add: 75 Lonsdale Street, Dandenong, VIC 3175
 Tel: 03 9791 6499



Pakenham
 Add: Factory 4, 100 Bald Hill Road, Pakenham VIC 3810
 Tel: 03 5948 3001



Bayswater
 Add: 236 Canterbury Road, Bayswater North, VIC 3153
 Tel: 03 9738 1006



Campbellfield
 Add: 45A Cooper Street, Campbellfield, VIC 3061
 Tel: 0475 796 666



Mentone
 Add: 36 Nepean Highway, Mentone, VIC 3194
 Tel: 03 9583 4799



Braybrook
 Add: 251 Ballarat Road, Braybrook, VIC 3019
 Tel: 03 9317 0962



Geelong
 Add: 257 Melbourne Road, North Geelong, VIC 3215
 Tel: 03 5277 1022

QLD

QLD Service Centre



Coopers Plains Factory
 Add: 100 Musgrave Road, Coopers Plains, QLD 4108



Townsville
 Add: 1/298 Bayswater Road, Garbutt, QLD 4814
 Tel: 07 4725 5280



Coopers Plains Shop
 Add: 754 Beaudesert Road, Coopers Plains, QLD 4108
 Tel: 07 3875 1066



Rockhampton
 Add: 397 Yaamba Road, Park Avenue, QLD 4701
 Tel: 07 4928 1977
 Fax: 07 4928 2977



Brendale
 Add: 65 Kremzow Road, Brendale, QLD 4500
 Tel: 07 3092 2530



Virginia
 Add: 2/2023 Sandgate Road, Virginia, QLD 4014
 Tel: 07 3865 3300
 Fax: 07 3633 0411



Gold Coast
 Add: 223 Brisbane Road, Labrador, QLD 4215
 Tel: 07 5537 7004
 Fax: 07 5537 7967

SA

SA Service Centre



Melrose Park
 Add: 969 South Road, Melrose Park, SA 5039
 Tel: 0413 113 969



Enfield
 Add: 453 Main North Road, Enfield, SA 5085
 Tel: 0413 113 929



Ottoway
 Add: 167 Grand Junction Road, Ottoway, SA 5013
 Tel: 0413 113 696

WA

WA Service Centre



O'Connor
 Add: 28 Peel Road, (Cnr of Stock Rd & Peel Rd) O'Connor, WA 6163
 Tel: 08 9337 1339
 Fax: 08 9337 1976

🌐 **Campbelltown** (reseller)

Add: 1/4A Hollylea Road, Leumeah NSW 2560
 Tel: 02 4625 2111

🌐 **Wagga Wagga** (reseller)

Add: 18 Chaston Street, Wagga Wagga, NSW 2650
 Tel: 0407 262 967

🌐 **Coffs Harbour** (reseller)

Add: 144A Pacific Highway, Coffs Harbour, NSW 2450
 Tel: 02 6651 6461

🌐 **Central Coast** (reseller)

Add: 338 Central Coast Highway, Erina, NSW 2250
 Tel: 02 4367 7690
 Fax: 02 4367 7894

🌐 **Taree** (reseller)

Add: 26-28 Oxley Street, Taree NSW 2430
 Tel: 02 6551 2479

🌐 **Camden** (reseller)

Add: 2/51 Topham Rd, Smeaton Grange NSW 2567
 Tel: 02 4607 2520



1800 554 434

VIC: www.toolboxmel.com.au