

Australia
NORWELD

UTE TRAYS AND CANOPIES

TRAYS | CANOPIES | TOOLBOXES



UTE TRAYS | CANOPIES | TOOLBOXES



YOUR JOURNEY STARTS HERE

Back yourself with Norweld's range of purpose-built tray and canopy packages, set up to suit your needs.

Norweld's expert team is ready to help you plan the right build from the start.

Call us today on **1300 302 899**

NOTHING BEATS A NORWELD	2
UTE TRAYS AND CANOPY BASES	4
HALF CANOPIES	10
LIFESTYLE CANOPIES	14
TRADIE CANOPIES	18
GULLWING TOOLBOXES	22
WIRING PACKAGES	26
ACCESSORIES	28

NOTHING BEATS A NORWELD.

Norweld ute trays and canopies are built unlike any other available, and we do mean that literally.

Our commitment to quality, and passion for innovation drive us to continuously push the boundaries of work and adventure.

Custom aluminium extrusions, designed by us, specifically for our products, form the frame of all Norweld trays and canopies.

Single sheets of aluminium form the roof, walls and floor of all our canopies and the deck of all our trays. This means no rivets and no seams.

You won't see our locks or taillights available anywhere else either. We've thought of everything, even down to the smallest details, to make sure everything not only works, but looks the best too.

Everything stays in place, exactly where it should with independently engineered, 10mm thick alloy welded mounts.

Finally, when it comes to installation, our skilled technicians will manage the relocation of factory cameras, sensors and radars, ensuring a flawless fit and smooth integration.

Braced doors that won't twist or buckle

Single piece aluminium canopy roof

Dual locking roller compression locks (exclusive to Norweld), central locking upgrade available

Two easy access side canopy doors with gutter system and rubber seal



LOCAL SERVICE
NATIONAL SUPPORT



LOCAL SERVICE, NATIONAL SUPPORT

It's not just our products that make us unbeatable. With eight Norweld owned branches around Australia, and over 20 Authorised Fitment Agents, you'll find a fitment location close to you. If you ever find yourself in need of assistance you're never on your own.

LIFETIME WARRANTY
ON WORKMANSHIP



LIFETIME WARRANTY ON ALL WORKMANSHIP

Norweld ute trays and canopies are designed and built to last a lifetime of use in some of the harshest conditions in Australia.

With precision laser cut and a fully welded aluminium construction, our ute trays and canopies deliver a strong lightweight build.



THE ORIGINAL HEAVY-DUTY TRAY MOUNT

Drive with confidence through tough terrain with 10mm thick welded aluminium mounts.

Part of the Norweld difference for over a decade.

AUSTRALIAN MADE & OWNED SINCE 1971

Being Australian Made and owned has always been something we are proud of. We don't just build the ultimate trays and canopies; we're dedicated to upholding the high standards of Australian manufacturing.

We're deeply passionate about passing on our skills and expertise to the next generation, empowering them to excel and continue the legacy of Australian craftsmanship.



Under tray water tank with headboard mounted filler and mounted tap on the driver side

Sequential LED tail lights (exclusive to Norweld)

Extruded sideboards and tailgate with built-in stiffeners

Heavy-duty stainless steel catches

High tensile, 4mm thick one-piece aluminium plate floor



UTE TRAYS AND CANOPY BASES

Deluxe Plus Tray (1850mm Length) |
Toyota LandCruiser 79 Dual Cab
Elite Tray (1850mm Length) |
Toyota HiLux Dual Cab

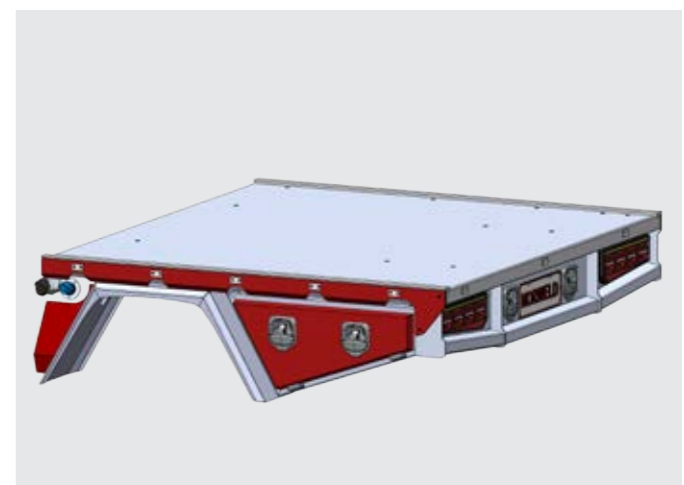

UTE TRAY

Our signature range of Deluxe, Deluxe Plus and Elite Trays are packed with premium features and come standard with sideboards, tailgate and headboard.

CANOPY BASE

For full-time canopy use, these bases save on overall mass and centralise weight with no headboard at the front of the deck.

ELITE TRAY

Elite Tray (1826mm Length) |
Ford Ranger Dual Cab



CONTEMPORARY HEADBOARD
Featuring 3mm router cut, colour-coded infill panel, and a mandrel bent tube with aerodynamic profile. Headboard base features integrated tie down points.



1200MM LONG REAR TRUNDLE DRAWER WITH DROP IN TABLE
Store tools, shovels or spare parts in a 1200mm dust and water resistant trundle drawer. Made with heavy-duty 227kg rated drawer slides. Drop in table included as standard.



UNDER TRAY TOOLBOXES WITH CONSTANT TORQUE HINGES
Secure under tray storage free from dust and water. Standard inclusion on all Norweld Trays. Premium hinges keep tension on toolbox lids to hold in position when open.

DELUXE PLUS TRAY



MANDREL-BENT TUBE HEADBOARD

76mm x 5mm mandrel-bent aluminium tube headboard with integrated spare wheel holders.



1200MM LONG REAR TRUNDLE DRAWER

Store tools, shovels or spare parts in a 1200mm dust and water resistant trundle draw. Made with heavy-duty 227kg rated drawer slides.



UNDER TRAY TOOLBOXES

Secure under tray storage free from dust and water. Standard inclusion on all Norweld Trays.

HALF CANOPIES



Deluxe Plus Tray (2526mm Length) |
Deluxe Dog Pod Half Canopy (950mm Length)
Toyota LandCruiser 79 Single Cab



BASIC CANOPY

Empty internal layout ready for you to configure with our range of optional bolt-in storage accessories.

DELUXE LITE CANOPY

Drivers side empty, with allocated space for fridge mounting on the passenger side.

DELUXE CANOPY

Drivers side features full-width lockable drawer, with allocated space for fridge mounting on the passenger side.

DELUXE DOG POD CANOPY

Vented and washable compartment on drivers side, with allocated space for fridge mounting on the passenger side.

Norweld half canopies are 950mm long.

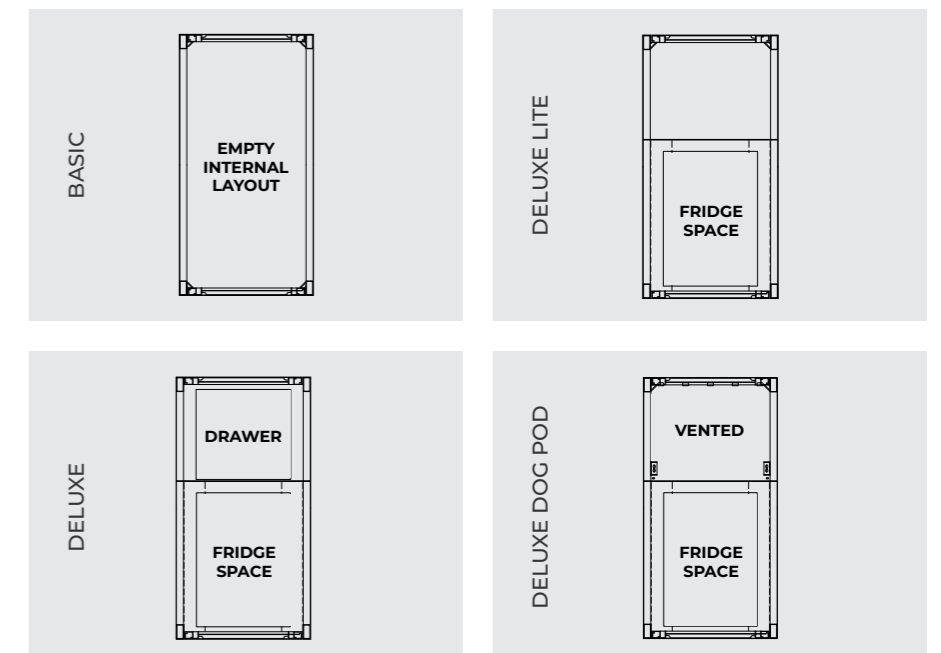

← FRONT OF VEHICLE

HALF CANOPIES



Deluxe Lite Half Canopy (950 Length) |
Elite Tray (1826mm Length) |
Isuzu D-MAX Dual Cab



BEST OF BOTH WORLDS

Our range of half canopies are designed to provide you with the flexibility of dust and water resistant storage, while retaining usable tray space.

These are a great option if you use your tray everyday but need a fridge and secure storage.

UPRIGHT OR DROP SLIDE FRIDGE COMPATIBLE

The choice is yours! Allocated space in Norweld Deluxe canopies to accommodate either an upright fridge or a Clearview Easy Slide to suit chest-style fridges and freezers up to 80L.

INCLUDED SHELF

Medium bolt-in overhead shelf measuring 600mm wide included in all Deluxe Lite, Deluxe and Deluxe Dog Pod Half Canopies as standard.



LIFESTYLE CANOPIES

Deluxe Canopy (1900mm Length) |
Elite Tray (1986mm Length) |
Chevrolet Silverado 2500



BASIC CANOPY

Empty internal layout ready for you to configure with our range of optional bolt-in storage accessories.

DELUXE LITE CANOPY

Drivers side empty, with allocated space for fridge mounting and slide out drawer and table on passenger side.

DELUXE CANOPY

Drivers side features 1200mm wide lockable drawer, with allocated space for fridge mounting and slide out drawer and table on passenger side.

DELUXE DOG POD CANOPY

Vented and washable compartment on drivers side, with allocated space for fridge mounting and slide out drawer and table on passenger side.

2-Door Canopies available in 1500mm, 1740mm, 2040mm and 2200mm lengths.

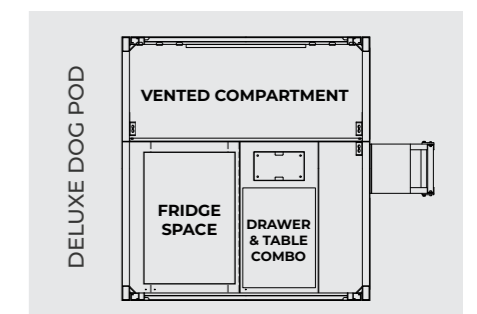
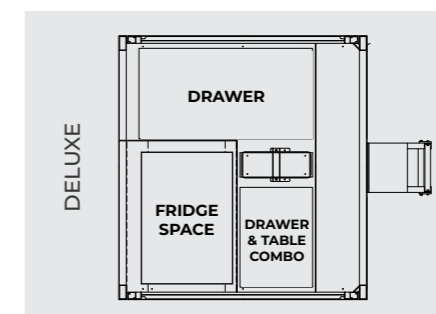
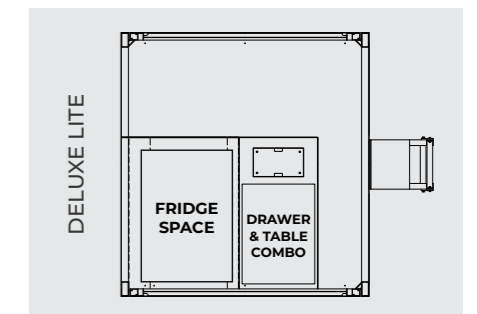
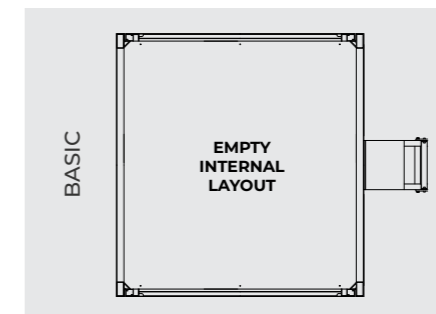

← FRONT OF VEHICLE

LIFESTYLE CANOPIES

Deluxe Lite Compact Canopy (1500mm Length) |
Deluxe Plus Tray (1826mm Length) |
Toyota LandCruiser 79 Dual Cab



HEAVY-DUTY DRAWER AND SLIDE OUT TABLE

Drawers are designed and built with a one-piece non-removable drawer runner, providing heavier load rating. Slide out drawer and table combo is available on Deluxe Lite, Deluxe and Deluxe Dog Pod Full Length and Compact canopies.

UPRIGHT OR DROP SLIDE FRIDGE COMPATIBLE

The choice is yours! Allocated space in Norweld Deluxe canopies to accommodate either an upright fridge or a Clearview Easy Slide to suit chest-style fridges and freezers up to 80L.

INCLUDED LARGE SHELF

Large bolt-in overhead shelf measuring 1075mm wide included in all Deluxe Lite, Deluxe and Deluxe Dog Pod Full Length and Compact canopies as standard.

TRADIE CANOPIES

Elite Tray (1950mm Width | 2126mm Length) |
 3-Door Contractor Canopy (1950mm Width | 2040mm Length)
 Ford Ranger Super Duty Extra Cab

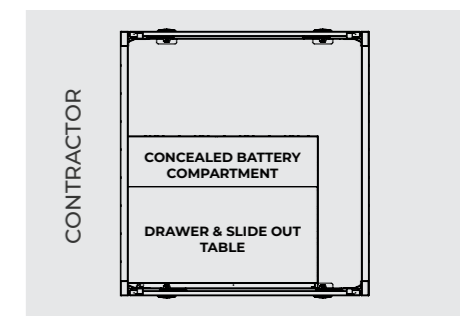
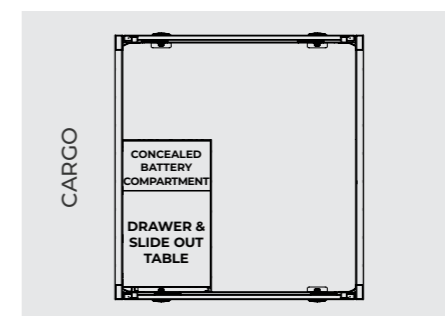
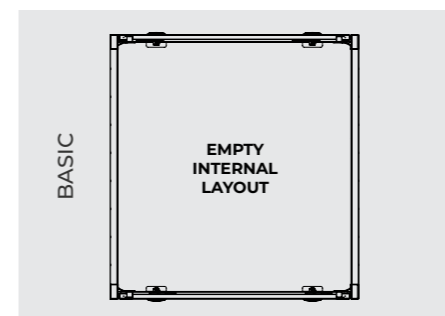

← FRONT OF VEHICLE

BASIC CANOPY

Ready for you to configure with our range of optional bolt-in storage accessories such as shelves and drawers as well as food storage and preparation gear like fridges.

CARGO CANOPY

Fully welded 510mm slide out drawer and table on passenger side. A concealed battery compartment is located behind the drawer.

CONTRACTOR CANOPY

Fully welded 1200mm slide out drawer and table on passenger side. A concealed battery compartment is located behind the drawer.

2-Door Canopies available in 1500mm, 1740mm, 2040mm and 2200mm lengths.
 3-Door Canopies available as full length only (1740mm, 2040mm and 2440mm).

TRADIE CANOPIES

Tradie 3-Door Cargo Canopy (1740mm Length) |
Elite Tray (1826mm Length) |
Ford Ranger Dual Cab



BOLT-IN STORAGE

Range of bolt-in shelves and drawers available to set up your canopy to work best for you and your tools.

Available as an optional accessory in 600mm and 1075mm widths.



BOLT-IN PARTITIONS

Segment equipment inside your canopy and create additional tie down points.

Available as an optional accessory in four sizes to suit all canopy configurations.



FLUSH CANOPY FLOOR

Ergonomic flush canopy floor reduces the risk of potential back injuries and assists with loading and unloading heavy or bulky equipment from your canopy.

Included as standard on all Tradie Canopies.



GULLWING TOOLBOXES

Diesel Fitter Gullwing Toolboxes (1500mm Length) |
 Deluxe Plus Tray (1826mm Length) |
 Toyota LandCruiser 79 Dual Cab



BASIC TOOLBOX

Empty internal layout ready for you to configure to with bolt-in adjustable shelves and dividers.

Available in 1500mm and 1740mm lengths.

DIESEL FITTER TOOLBOX

Pre-configured drawer and shelf layout to accommodate tools and parts of all sizes. Using our innovative, grease-free poly drawer slides, these drawers will not jam from built up dust or dirt.

Available in 1500mm length.

GULLWING TOOLBOXES

Dual Basic Gullwing Toolbox (1500mm Length) |
 Deluxe Plus Tradie Tray (1826mm Length) |
 Toyota HiLux Dual Cab



REAR GATE

Helps restrict loose items and creates a secure, ventilated storage space between two toolboxes.

Made with premium constant torque hinges, and Norweld exclusive dual locking roller compression locks.

Available as an optional accessory.

HEADBOARD GUARD

Protects your rear windscreen when running a full-time canopy without a headboard.

It also helps restrict loose items and reduces the risk of them protruding through the rear windscreen.

Available as an optional accessory.

CENTRE TILT ROOF

Strut-assisted action helps lifting the tilt roof, while the grab handle doubles as a locking device when the rear gate is closed. It also helps create a secure, ventilated space inside your canopy.

The design allows for a 120W solar panel on top.

Available as an optional accessory.

WIRING PACKAGES

No Norweld canopy package is complete without one of our canopy wiring packages. These kits are designed to cater for everything from everyday use to serious overlanding and long-distance travel.

Scan or visit the link below for more information on Norweld's range of wiring packages.

norweld.com.au/wiring-packages

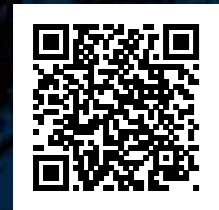

WEEKENDER WIRING

The Enerdrive Weekender Wiring Package includes a 100Ah lithium battery and a 40Ah DC-to-DC charger.

This entry level wiring package is great for short trips away and will power your 12V fridge, lights, Travel Buddy Oven and central locking for your canopy.

TOURER WIRING

The Enerdrive Tourer Wiring Package takes your canopy to a new level.

With a 1000W inverter this package can handle smaller current drawing tasks such as charging your power tools, drones and computers, as well as powering your 12V fridges, lights and accessories.

EXTREME WIRING

The Enerdrive Extreme Wiring Package can power any off-grid journey you can dream of.

With a 2000W inverter this package can handle larger current drawing appliances such as coffee machines and cooktops, as well as your 12V fridge, lights and charging your power tools, drones and computers.



ON-SITE SERIES

Built for our Tradie range of canopies and Gullwing Toolboxes, the On-Site Series Wiring packages will handle any work day. With enough power to charge your tools and laptop, as well as keeping your drinks cold and your smoko hot.

ULTIMATE WIRING

With a 2000W inverter, increased battery capacity and the Manager 30 BMS this package can handle larger current drawing appliances such as coffee machines and cooktops, as well as your 12V fridge, lights and charging your tools.

PLATINUM WIRING

The Platinum Wiring Package is Norweld's flagship wiring solution. Redarc's TVMS allows you to control, monitor and set up automation for your canopy. This package can handle larger current drawing appliances such as a coffee machines and cooktops, as well as your 12V fridge, lights and charging your power tools, drones and computers.

ACCESSORIES

"THIS DEFIES ALL PHYSICS. IT'S AN ANTI-GRAVITY PANTRY. ... NONE OF THIS STUFF HAS BOUNCED OUT, NONE OF IT. ..."
RONNY DAHL



BOLT-IN PANTRY

Mounted into the roof of the canopy, the bolt-in pantry is a drop-down shelving option ideal for storing food and condiments.



WIND OFF JACKS

Wind off jacks come as a set of four with handles to allow easy removal of your canopy.



TRAVEL BUDDY OVEN KIT

Fast food takes on a new meaning with the Travel Buddy. This portable, lightweight, 12V oven can cook, bake and warm foods while you travel.

Conveniently install it into your Norweld canopy with our specially designed bolt-in mount that secures to the canopy roof.



JERRY CANS AND HOLDER

Norweld designed and made jerry can holder is bolted into the spare tyre mounts of your tray or canopy.

Norweld jerry cans are Australian made and come in two options:

- 25L Water (grey)
- 25L Diesel (black)



AIR COMPRESSOR AND TANK

Whether it's inflating your tyres after hitting the beach or blowing off some bulldust, our twin air compressor kit is a great add on for your canopy. Featuring the ARB twin motor design and a 4L air tank, an additional hose, air duster and tyre inflator.

Installed securely to the ceiling of your canopy with a Norweld designed and built bracket.



UPRIGHT FRIDGE

Norweld offers mounting options for the following models:

- 95L Engel Upright Fridge
- 110L Dometic Upright Fridge
- 116L Dometic NRX115 Upright
- 130L Bushman Upright Fridge

The Bushman 130L upright fridge is also available from Norweld.



CLEARVIEW EASY SLIDE

This state-of-the-art fridge lowering slide is easy to use and access from within your canopy.

Smoothly lowers the fridge up to 290mm, with the option of 3 different platform heights to choose from.

Unobtrusive handle allows for uninterrupted access to your fridge.



Australia
NORWELD
UTE TRAYS AND CANOPIES

Cairns

139-143 Hartley Street
Bungalow QLD 4870

Townsville

6/547 Woolcock Street
Mount Louisa QLD 4814

Brisbane

56 Griffin Crescent
Brendale QLD 4500

Newcastle

4/5 Coal Wash Drive
Mayfield West NSW 2304

Sydney

2/1003-1009 Canley Vale Road
Wetherill Park NSW 2164

Melbourne

2/37 Garden Street
Kilsyth VIC 3137

Adelaide

24 Fifth Street
Bowden SA 5007

Perth

22 Opportunity Street
Wangara WA 6065

For more information
visit norweld.com.au
or call 1300 302 899

LOCAL SERVICE
NATIONAL SUPPORT

LIFETIME WARRANTY
ON WORKMANSHIP



NORWELD.COM.AU | 1300 302 899



GET A QUOTE

