



LED STRIP CATALOGUE

VIVALYTE B.V.
Tel.: +32 56 42 65 35
Mail: info@vivalyte.com Web: www.vivalyte.com
Add.: Kouterstraat 6, Wevelgem, B-8560, Belgium VAT: BE500611159
Rev.: June 2021

- 003 2110 Series
- 017 Flexible Panel Series

- 047 2016 LED Series
- 049 2835 LED Series
- 051 3528 LED Series
- 053 5050 LED Series



- 023 Long Run Series
- 029 Current Regulator And High Efficacy Series
- 039 MINI Series

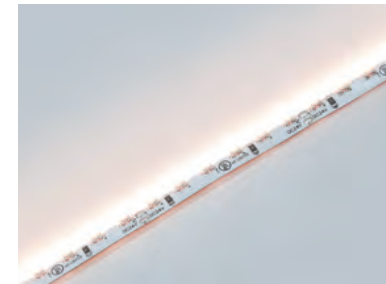

- 085 Side Emitting Series
- 087 Short Cutable Series
- 091 Constant Current Drive Series

- 055 CCT/Color Controllable Series
- 073 Digital Series
- 079 Linear
- 083 Dim To Warm Series



- 093 Power Supply
- 094 Indoor Power Supply
- 095 Accessories
- 096 Quick Connector
- 098 LED Controller

2110 SERIES

Backlit, aluminum profile
and other lighting.

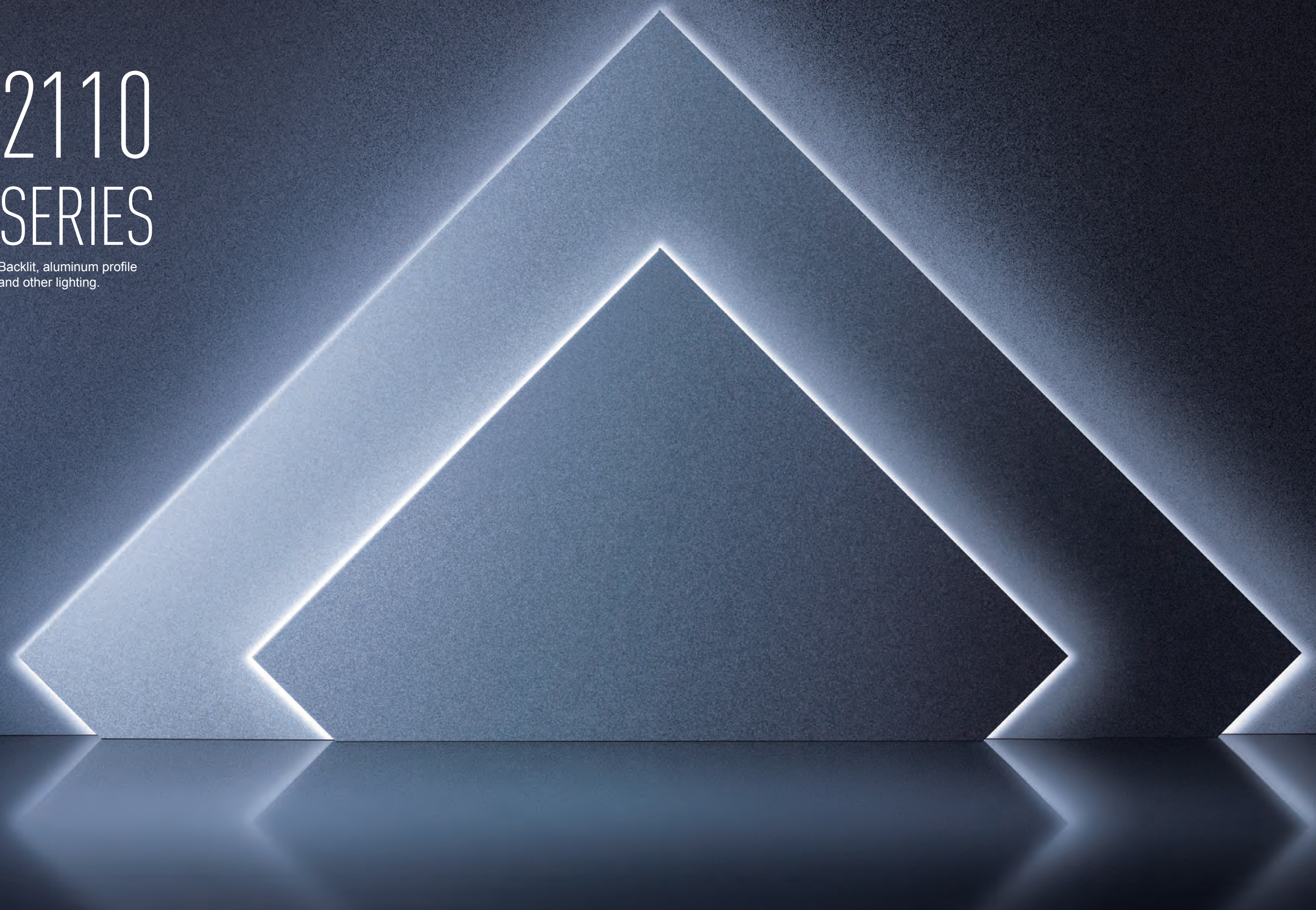

2110 STANDARD SERIES



DC 24V **5 yrs warranty**

Color Available



Optical & Electrical Parameters

Model No.	Light Color	Color Temperature(K)	Luminous Flux(lm/m)	CRI/Ra	Efficacy(lm/W)	Power(W/m)
VFN-2110-266-24	W	2700-6000	1203-1381	90/95+	88-100	13.68
VFN-2110-350-24			1296-1497		90-104	14.40
VFN-2110-490-24			1495-1747		89-104	16.8
VFN-2110-630-24			1876-2203		87-102	21.6
VFN-2110-700-24			1970-2300		82-96	24

Other Parameters

Model No.	LED Quantity(pcs/m)	Max Run(m/inch)	Min Cuttable Length (mm/inch)	Standard Packing Size/Reel L*W(mm/inch)
VFN-2110-266-24	266	4.0[157.48]	26.3 [1.04]	5000X10 [196.85X0.39]
VFN-2110-350-24	350	4.0[157.48]	20.0 [0.79]	
VFN-2110-490-24	490	3.5[137.79]	14.3 [0.56]	
VFN-2110-630-24	630	3.0[118.11]	11.1 [0.44]	
VFN-2110-700-24	700	2.5[98.42]	10.0 [0.39]	

Profile Drawings

Length Unit : mm/inch

VFN-2110-266-24

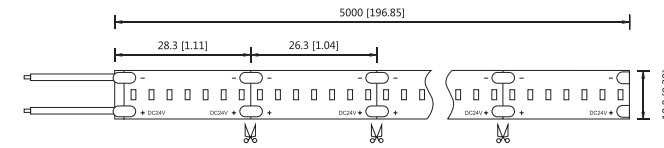

VFN-2110-630-24

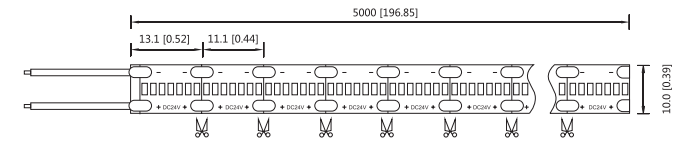

VFN-2110-350-24

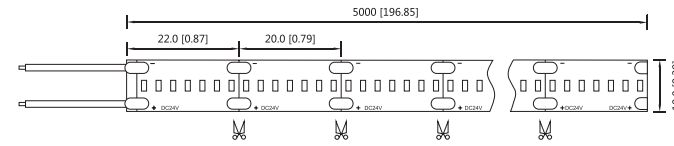

VFN-2110-700-24

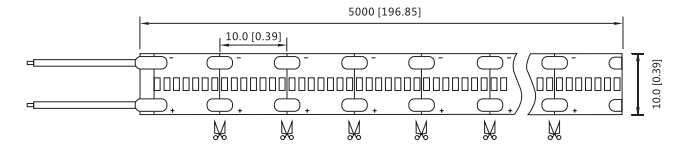

VFN-2110-490-24

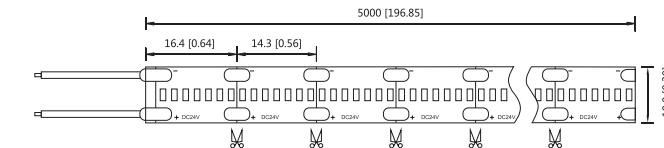

Joint



VFN-W10CF2 VFN-W10FF2 S10W1 S10W2 S10W0

NOTE: Only show IP22 accessories list, Please refer to the accessories page for the list of other waterproof accessories

Aluminum Profile

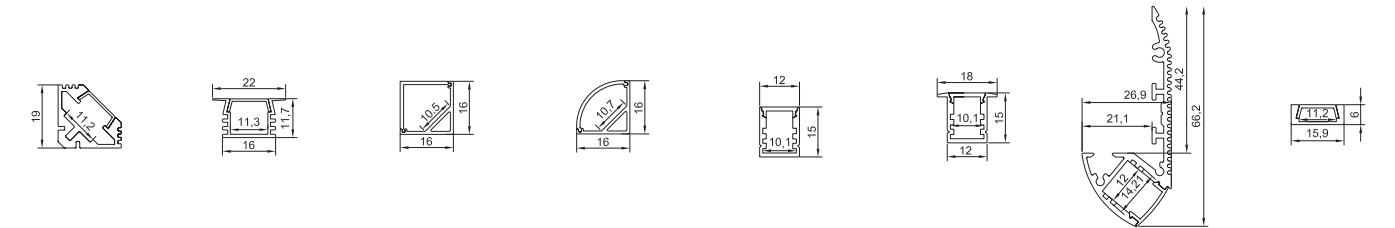

SL191911-A SL221211-A SL161610-B SL161610-A SL121510-A SL181510-A XT662712-A SL150611-A

NOTE: Only some common profiles are displayed, please refer to the list of specific profiles for the rest

2110 MINI SERIES

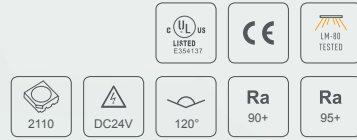

DC 24V **5 yrs warranty**

Color Available



Optical & Electrical Parameters

Model No.	Light Color	Color Temperature(K)	Luminous Flux(lm/m)	CRI/Ra	Efficacy(lm/W)	Power(W/m)
VMN-2110-238-24	W	2700	1052	90/95+	86	12.24
		3000	1077		88	
		4000	1126		92	
		5000	1187		97	
		6000	1224		100	

Other Parameters

Model No.	LED Quantity(pcs/m)	Max Run(m/inch)	Min Cuttable Length (mm/inch)	Standard Packing Size/Reel L*W(mm/inch)
VMN-2110-238-24	238	2.0[78.74]	29.4[1.16]	5000X4[196.85X0.16]

Profile Drawings

Length Unit : mm/inch

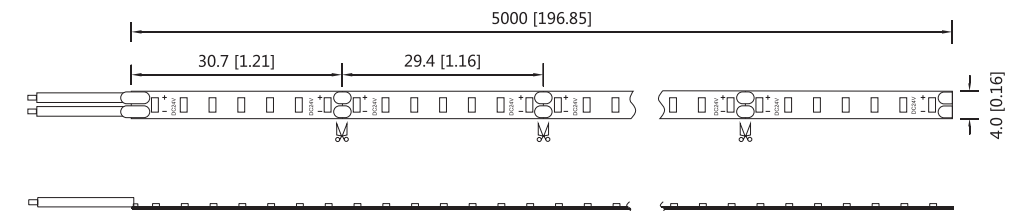

Aluminum Profile



SL080805-A



SL080804-A



SL161508-A



SL101508-A

NOTE: Only some common profiles are displayed, please refer to the list of specific profiles for the rest

2110 CURRENT REGULATOR SERIES



DC 24V **5 yrs warranty**

Color Available

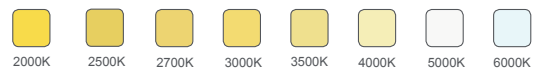

Optical & Electrical Parameters

Model No.	Light Color	Color Temperature(K)	Luminous Flux(lm/m)	CRI/Ra	Efficacy(lm/W)	Power(W/m)
VCN-2110-216-24	W	2700	778	90/95+	60	13.0
		3000	792		61	
		4000	843		65	
		5500	880		68	
		6000	905		70	

Other Parameters

Model No.	LED Quantity(pcs/m)	Max Run(m/inch)	Min Cuttable Length (mm/inch)	Standard Packing Size/Reel L*W(mm/inch)
VCN-2110-216-24	216	8.0[314.96]	27.8 [1.09]	5000X10 [196.85X0.39]

Profile Drawings

Length Unit : mm/inch

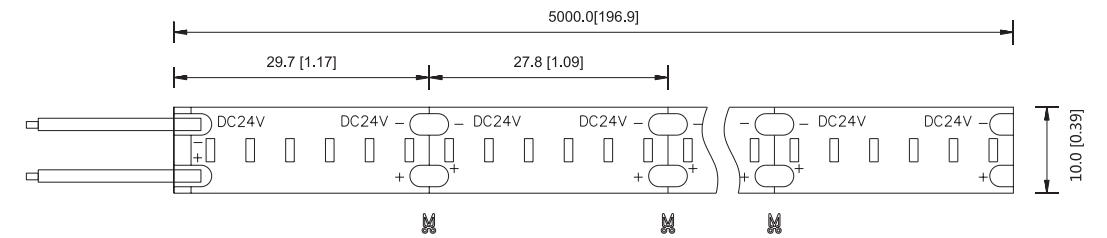

clip



VFN10MC

NOTE: Only show IP22 accessories list, Please refer to the accessories page for the list of other waterproof accessories

Joint



VFN-W10CF2

VFN-W10FF2

S10W1

S10W2

S10W0

NOTE: Only show IP22 accessories list, Please refer to the accessories page for the list of other waterproof accessories

Aluminum Profile

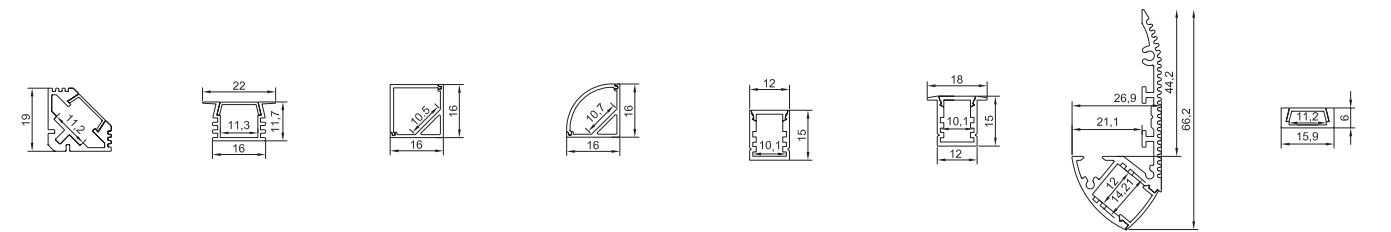

SL191911-A

SL221211-A

SL161610-B

SL161610-A

SL121510-A

SL181510-A

XT662712-A

SL150611-A

NOTE: Only some common profiles are displayed, please refer to the list of specific profiles for the rest

2110 RGB/RGBW SERIES



DC 24V **4** yrs warranty

Color Available

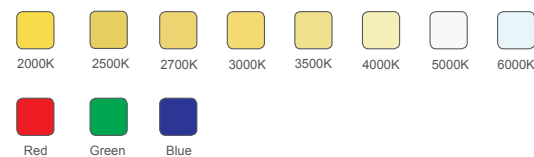

Optical & Electrical Parameters

Model No.	Light Color	Color Temperature/Wavelength(K/nm)	Typical Luminous Flux (lm/m)	CRI/Ra	Efficacy(lm/W)	Power(W/m)
VTN-2110-384-24-RGBW	R	620-625	48	--	--	3.84
	G	460-470	68	--	--	3.84
	B	515-520	330	--	--	3.84
	R+G+B	100000	435	--	--	11.52
	W	2000-6000	343	90+	89	3.84
	R+G+B+W	12000	756	--	--	15.36
VTN-2110-396-24-RGB	R	620-625	52	--	--	5
	G	515-520	414	--	--	5
	B	465-470	106	--	--	5
	RGB	100000	575	--	--	15

Other Parameters

Model No.	LED Quantity(pcs/m)	Max Run(m/inch)	Min Cuttable Length (mm/inch)	Standard Packing Size/Reel L*W(mm/inch)
VTN-2110-384-24-RGBW	384	3.0[118.11]	62.5[2.46]	5000X10 [196.85X0.39]
VTN-2110-396-24-RGB	396	1.0[39.37]	45.5[1.79]	5000X8 [196.85X0.31]

Profile Drawings

Length Unit : mm/inch

VTN-2110-384-24-RGBW

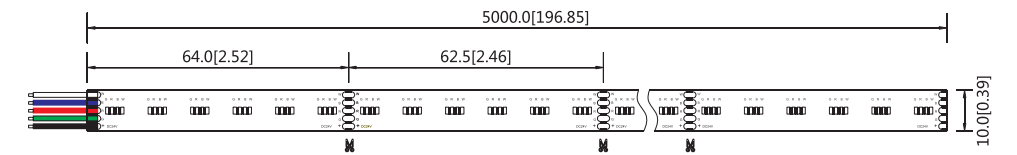

VTN-2110-396-24-RGB

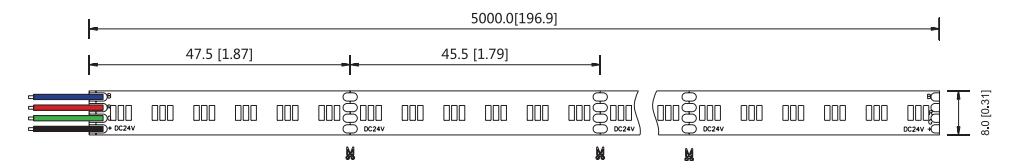

clip



VFN10MC



VFN08MC

NOTE: Only show IP22 accessories list, Please refer to the accessories page for the list of other waterproof accessories

Aluminum Profile

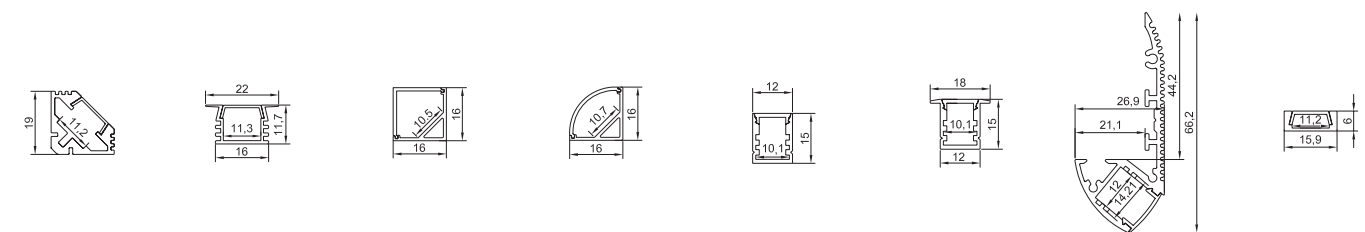

SL191911-A SL221211-A SL161610-B SL161610-A SL121510-A SL181510-A XT662712-A SL150611-A

NOTE: Only some common profiles are displayed, please refer to the list of specific profiles for the rest

2110 CCT TUNABLE SERIES



DC 12V/24V **4** yrs warranty

Color Available



Optical & Electrical Parameters

Model No.	Light Color	Color Temperature/Wavelength(K/nm)	Typical Luminous Flux (lm/m)	CRI/Ra	Efficacy(lm/W)	Power(W/m)
VTN-2110-240-12-CW	WW	2000	384	90+	53	7.2
	CW	6500	547	90+	76	7.2
VTN-2110-280-24-CW	WW	2000	470	90+	65	7.2
	CW	6500	670	90+	93	7.2

Other Parameters

Model No.	LED Quantity(pcs/m)	Max Run(m/inch)	Min Cuttable Length (mm/inch)	Standard Packing Size/Reel L*W(mm/inch)
VTN-2110-240-12-CW	240	1.5[59.05]	25[0.98]	5000X8 [196.85X0.31]
VTN-2110-280-24-CW	384	3.0[118.11]	50[1.97]	5000X8 [196.85X0.31]

Profile Drawings

Length Unit : mm/inch

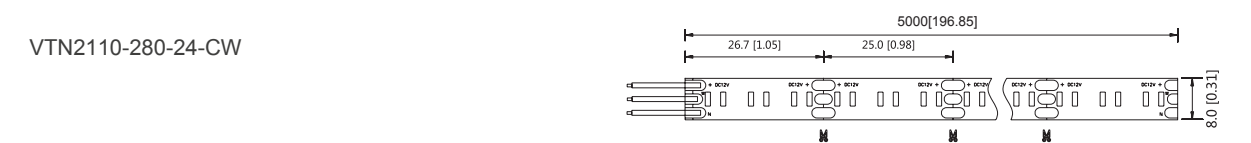
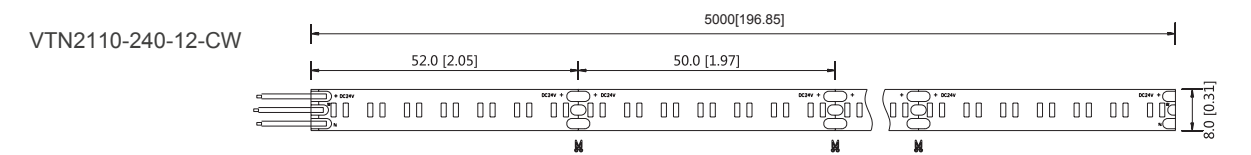

clip



VFN08MC

NOTE: Only show IP22 accessories list, Please refer to the accessories page for the list of other waterproof accessories

Aluminum Profile



NOTE: Only some common profiles are displayed, please refer to the list of specific profiles for the rest

2110 DIM TO WARM



ZL 2017 2 1153882.0

DC 24V **5 yrs warranty**

Color Available



Optical & Electrical Parameters

Model No.	Light Color	Color Temperature/Wavelength(K/nm)	Typical Luminous Flux (lm/m)	CRI/Ra	Efficacy(lm/W)	Power(W/m)
VPTW-2110-224-24-WN	WW	2000	690	90+	60	12
	CW	6500	1036	90+	90	12

Other Parameters

Model No.	LED Quantity(pcs/m)	Max Run(m/inch)	Min Cuttable Length (mm/inch)	Standard Packing Size/Reel L*W(mm/inch)
VPTW-2110-224-24-CW	224	4.0[157.48]	62.5[2.46]	5000X12 [196.85X0.47]

Profile Drawings

Length Unit : mm/inch

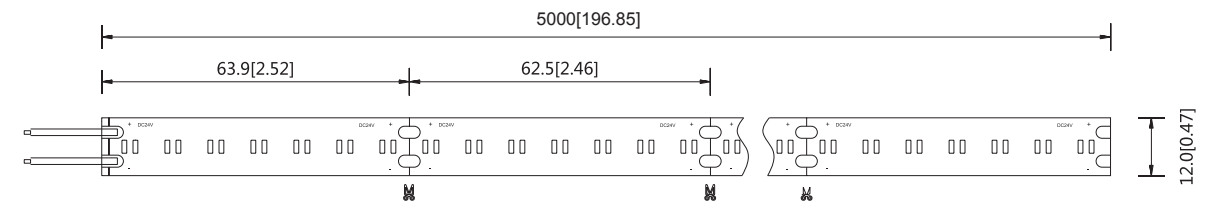

clip



VFN12MC

NOTE: Only show IP22 accessories list, Please refer to the accessories page for the list of other waterproof accessories

Aluminum Profile

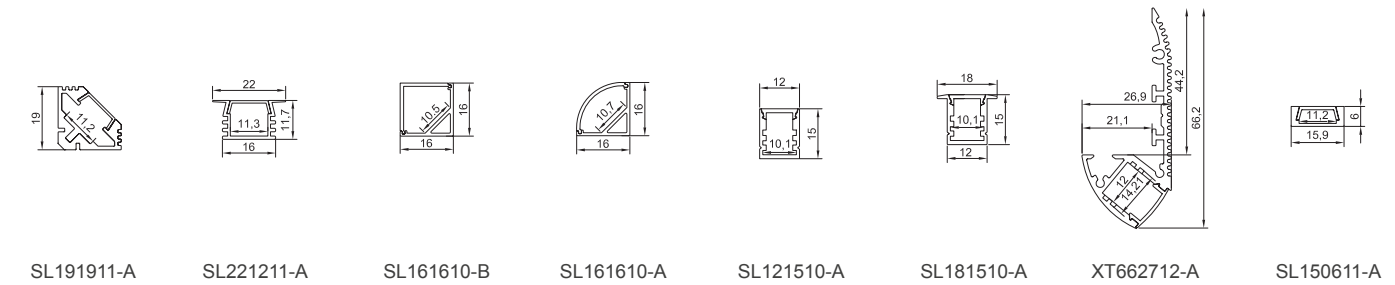

NOTE: Only some common profiles are displayed, please refer to the list of specific profiles for the rest

FLEXIBLE PANEL

Light box, signage, general lighting and costume etc.

Curving Space Applications

Architectural Area Lighting

Illuminated Signage

Luminous Ceilings

Large Graphic Displays

Back-lit Lighting Box



H150 SERIES

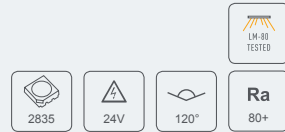

Smart Lighting

DC 24V **3** yrs warranty

Color Available (Tunable White)

Dimension Unit : mm/inch

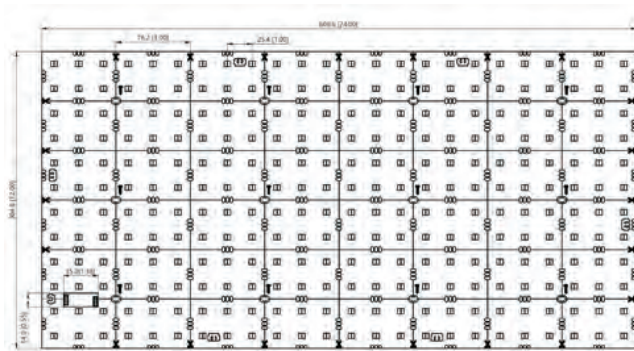
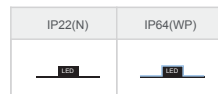

Note: Data of other CCT, please consult with sales rep.

Optical & Electrical Parameters

Model No.	Light Color	Color Temperature/Wavelength(K/nm)	Luminous Flux(lm/pc)	CRI/Ra	Efficacy(lm/W)	Power(W/pc)
VLE-H150-WN-TN2835-576-24	W	6500	2188	80+	95	23
	N	2700	2096	80+	91	23
	W+N	4300	4285	80+	93	46

Other Parameters

Model No.	LED Quantity(pcs)	Max Run (pc/inch)	Min Cuttable Length (mm/inch)	Standard Packing Length L*W(mm/inch)
VLE-H150-WN-TN2835-576-24	576	3	76.2X50.8[3.0X2.0]	610X305[24.01X12.00]

Accessories

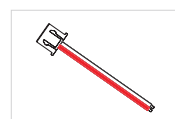

XH-2Y Power cable

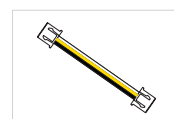

XH-3Y Joint line

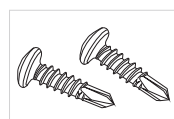

Screw

H150 SERIES



Smart Lighting

DC 24V **3** yrs warranty

Color Available

Dimension Unit : mm/inch

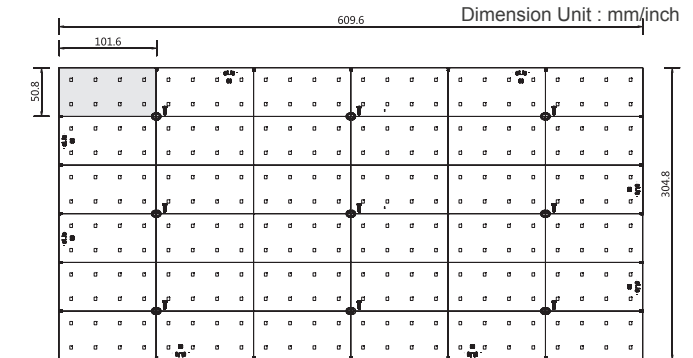
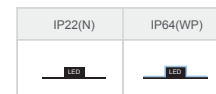

Note: Data of other CCT, please consult with sales rep.

Optical & Electrical Parameters

Model No.	Light Color	Color Temperature/Wavelength(K/nm)	Luminous Flux(lm/pc)	CRI/Ra	Efficacy(lm/W)	Power(W/pc)
VLE-H150-W-CNH2835-288-24	W	3000	3110	80+	120	25.92
		4000	3162		122	
		5000	3214		124	
		6500	3266		126	

Other Parameters

Model No.	LED Quantity(pcs)	Max Run (pc/inch)	Min Cuttable Length (mm/inch)	Standard Packing Length L*W(mm/inch)
VLE-H150-W-CNH2835-288-24	288	5	101X50.8[3.97X2.0]	610x305[24.0X12.0]

Accessories

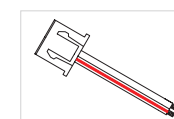

XH-2Y Power cable

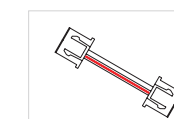

XH-2Y Joint line

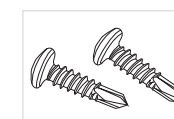

Screw

H150 SERIES

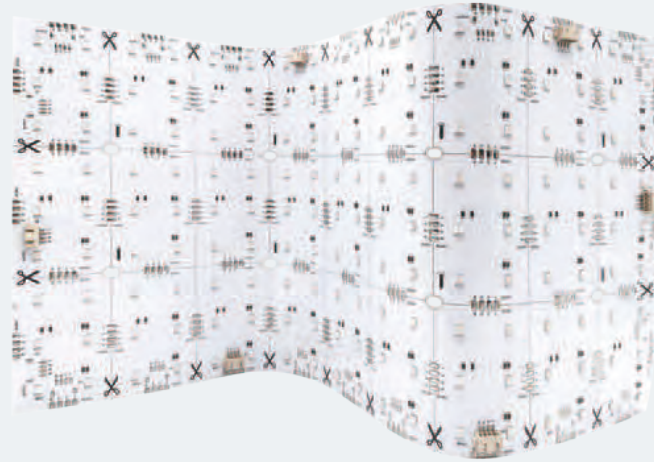
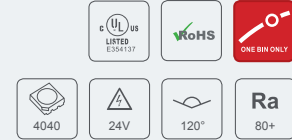

Smart Lighting

DC 24V **3** yrs warranty

Color Available



IP22(N)	IP64(WP)

Dimension Unit : mm/inch

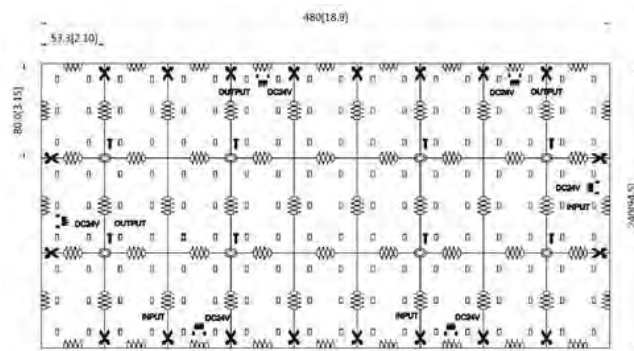

Optical & Electrical Parameters

Model No.	Light Color	Color Temperature(K)	Luminous Flux(lm/pc)	CRI/Ra	Efficacy(lm/W)	Power(W/pc)
VLE-H150-RGB-TN4040-162-24	R	615-630	272	--	28	9.72
	G	515-530	457	--	47	9.72
	B	460-470	102	--	10.5	9.72
	RGB	100000	845	--	29	29.16

Other Parameters

Model No.	LED Quantity(pcs)	Max Run (pc/inch)	Min Cuttable Length (mm/inch)	Standard Packing Length L*W(mm/inch)
VLE-H150-RGB-TN4040-162-24	162	4	80X53.3[3.15X2.10]	480X240[18.89X9.44]

Accessories

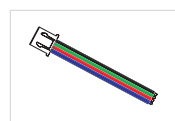

XH-4Y Power cable

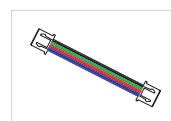

XH-4Y Joint line

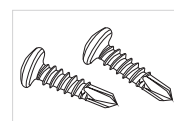

Screw

H150 SERIES

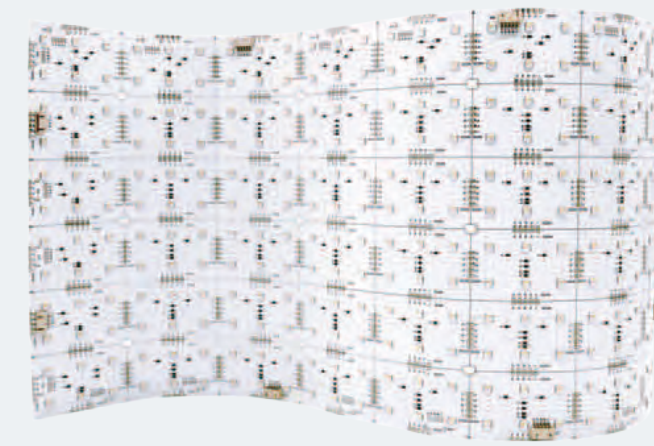
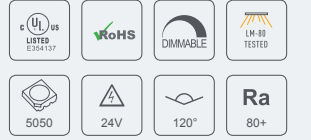

Smart Lighting

DC 24V **3** yrs warranty

Color Available

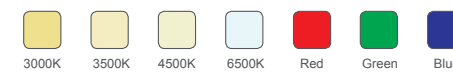

IP22(N)	IP64(WP)

Dimension Unit : mm/inch

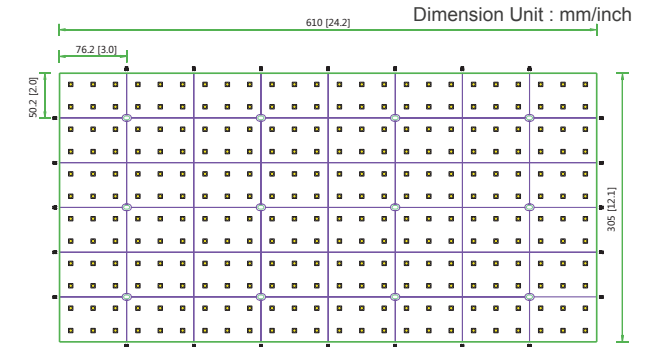

Optical & Electrical Parameters

Model No.	Light Color	Color Temperature(K)	Luminous Flux(lm/pc)	CRI/Ra	Efficacy(lm/W)	Power(W/m)
VLE-H150-RGBW-TN5050-288-24	R	615-630	296	--	--	11.5
	G	515-530	845	--	--	11.5
	B	460-470	171	--	--	11.5
	W	3000	1034	90+	90	11.5
	R+G+B	100000	1274	--	--	34.5
	RGB+W	100000	2200	--	--	46.0

Other Parameters

Model No.	LED Quantity(pcs)	Max Run (pc/inch)	Min Cuttable Length (mm/inch)	Standard Packing Length L*W(mm/inch)
VLE-H150-RGBW-TN5050-288-24	288	2	76.2X50.8[3.0X2.0]	610X305[24.01X12.00]

Accessories

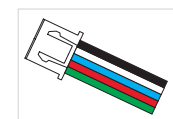

XH-5Y Power cable

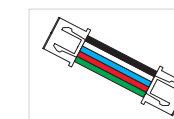

XH-5Y Joint line



Screw

LONG RUN SERIES



Ideal for the residential and commercial use,
such as kitchen, bedroom, closet, stair, shops,
retails, offices etc.

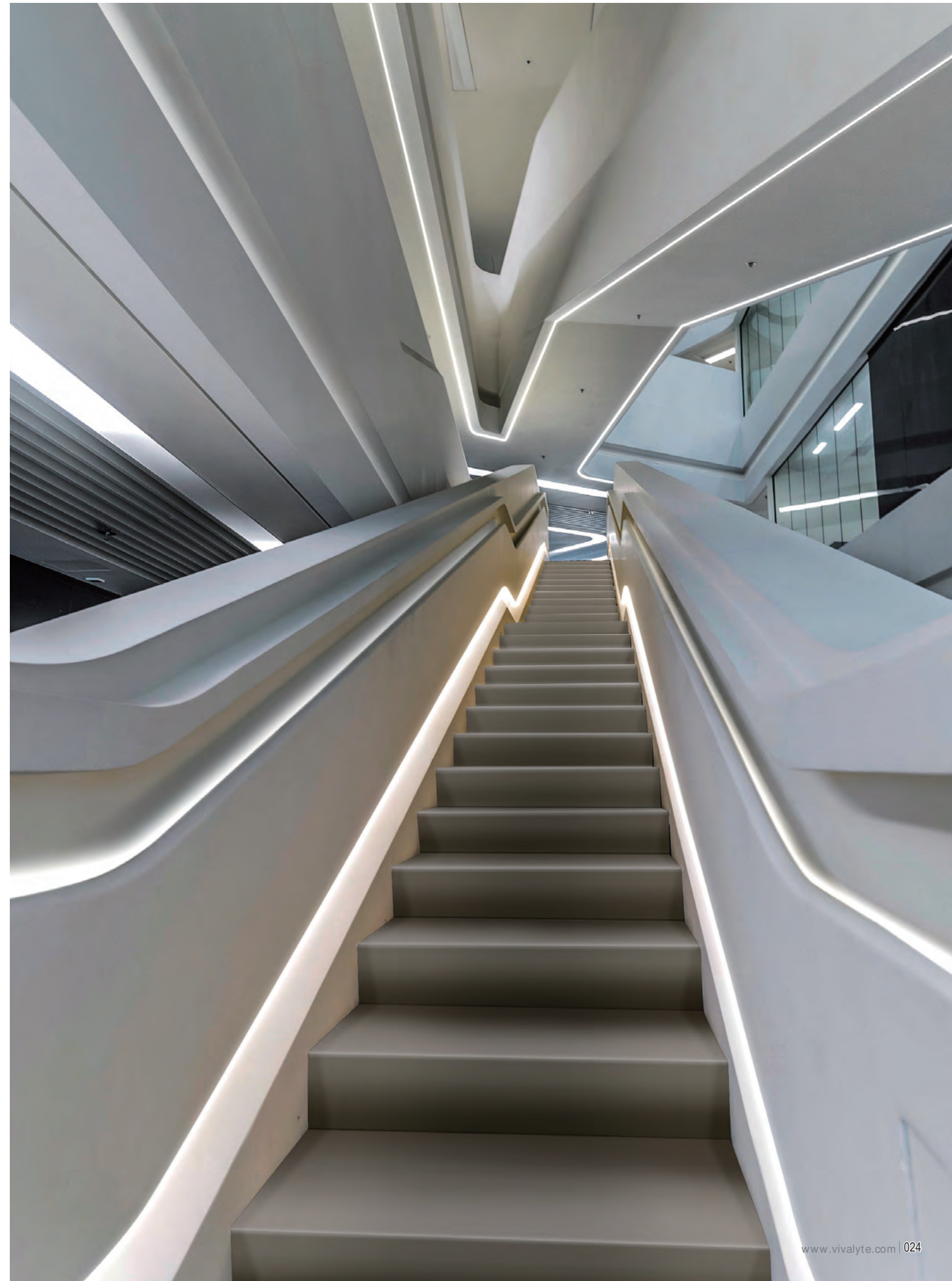

LONG RUN SERIES

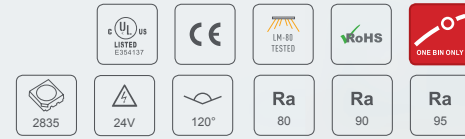

DC 24V **5** yrs warranty

Color Available

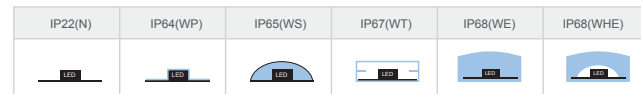
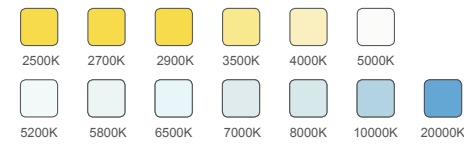

Optical & Electrical Parameters

Model No.	Light Color	Color Temperature(K)	Luminous Flux(lm/m)	CRI/Ra	Efficacy(lm/W)	Power(W/m)
VLN-2835A-60-24-5W	W	1900-9000	423-449	80+	84-89	5.04
VLN-2835A-120-24-6W	W	1900-9000	516-546	80+	84-89	6.0
VLN-2835A-120-24-10W	W	1900-9000	847-897	80+	84-89	10.8

Other Parameters

Model No.	LED Quantity(pcs/m)	Max Run(m/inch)	Min Cuttable Length (mm/inch)	Standard Packing Size/Reel L*W(mm/inch)
VLN-2835A-60-24-5W	60	21[826.77]	100[3.94]	50000X10[1968.50X0.39]
VLN-2835A-120-24-6W	120	21[826.77]	50[1.97]	50000X10[1968.50X0.39]
VLN-2835A-120-24-10W	120	16[629.92]	50[1.97]	50000X10[1968.50X0.39]

Profile Drawings

Length Unit : mm/inch

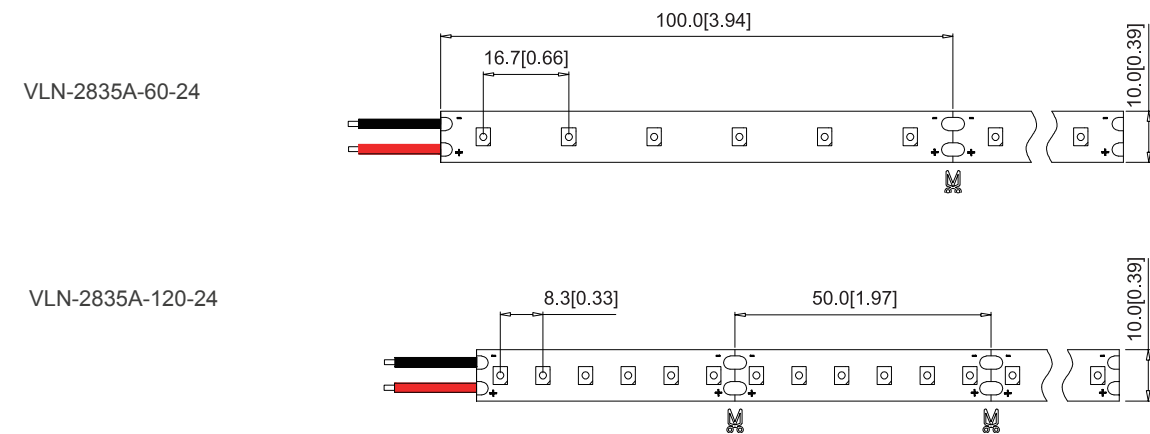

clip



VFN10MC

NOTE: Only show IP22 accessories list, Please refer to the accessories page for the list of other waterproof accessories

Joint



VFN-W10CF2

VFN-W10FF2

S10W1

S10W2

NOTE: Only show IP22 accessories list, Please refer to the accessories page for the list of other waterproof accessories

Aluminum Profile

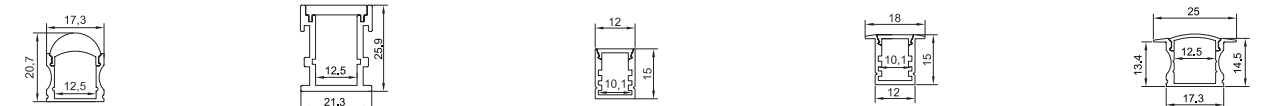

SL172012-A

SL212612-A

SL121510-A

SL181510-A

SL251512-A

NOTE: Only some common profiles are displayed, please refer to the list of specific profiles for the rest

LONG RUN SERIES



DC 24/36V **5** yrs warranty

Color Available



NOTE: Only non-waterproof can be made for 50 meters long each

Optical & Electrical Parameters

Model No.	Light Color	Color Temperature(K)	Luminous Flux(lm/m)	CRI/Ra	Efficacy(lm/W)	Power(W/m)
VLN-H2835-60-24-2.4W	W	1900-9000	182-211	80+	76-88	2.4
VLN-H2835-80-36-5.2W	W	1900-9000	477-529	80+	92-102	5.2

Other Parameters

Model No.	LED Quantity(pcs/m)	Max Run(m/inch)	Min Cuttable Length (mm/inch)	Standard Packing Size/Reel L*W(mm/inch)
VLN-H2835-60-24-2.4W	60	50[1968.50]	100[3.94]	50000X10[1968.50X0.39]
VLN-H2835-80-36-5.2W	80	50[1968.50]	125[4.92]	50000X10[1968.50X0.39]

Profile Drawings

Length Unit : mm/inch

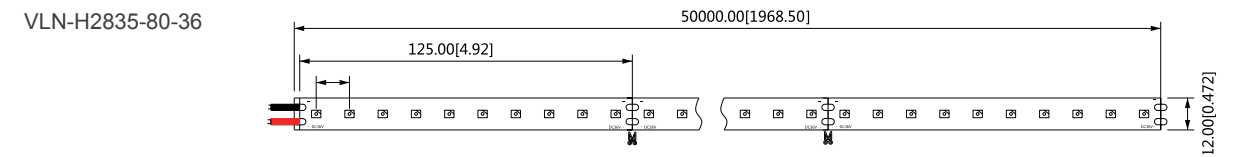
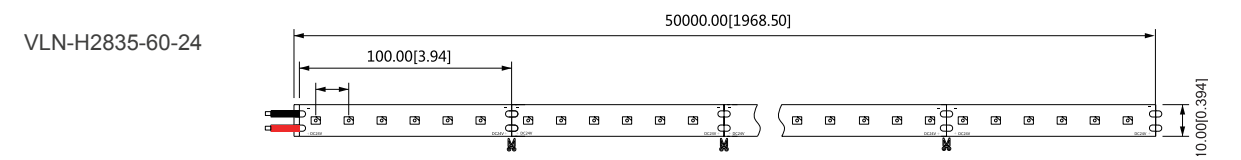

clip



VFN10MC



VFN12MC

NOTE:
Only show IP22 accessories list, Please refer to the accessories page for the list of other waterproof accessories

Joint



VFN-WC10CF2



VFN-WC10FF2



S10W1



S10W2

NOTE: Only show IP22 accessories list, Please refer to the accessories page for the list of other waterproof accessories

Aluminum Profile



SL172012-A

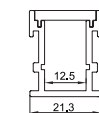

SL212612-A



SL121510-A



SL181510-A

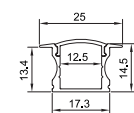

SL251512-A

NOTE: Only some common profiles are displayed, please refer to the list of specific profiles for the rest

CURRENT REGULATOR AND HIGH EFFICACY SERIES

Indoor and outdoor decorative lighting, general lighting, channel letters, signage, light box, costumes, artware etc.



CURRENT REGULATOR HIGH EFFICACY SERIES

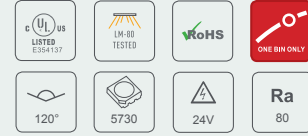

DC 24V **5** yrs warranty

Color Available

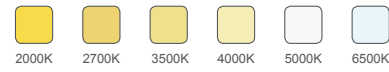

Optical & Electrical Parameters

Model No.	Light Color	Color Temperature(K)	Luminous Flux(lm/m)	CRI/Ra	Efficacy(lm/W)	Power(W/m)
VCN-H5730-64-24	W	3000-6500	2195-2400	80+	141	11.52
VCN-H5730-128-24	W	3000-6500	2800-3000	80+	136	23.04

Other Parameters

Model No.	LED Quantity(pcs/m)	Max Run(m/inch)	Min Cuttable Length (mm/inch)	Standard Packing Size/Reel L*W(mm/inch)
VCN-H5730-64-24	64	5.0[196.9]	125[4.92]	5000X10[196.85X0.39]
VCN-H5730-128-24	128	6.5[255.90]	62.5[2.46]	5000X10[196.85X0.39]

Profile Drawings

Length Unit : mm/inch

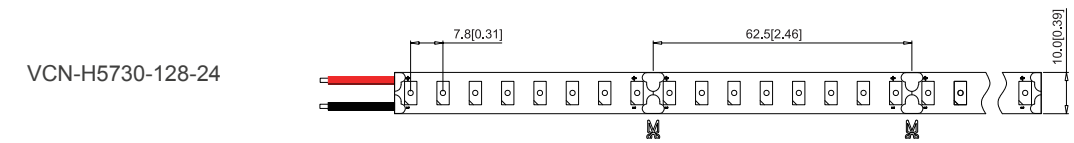
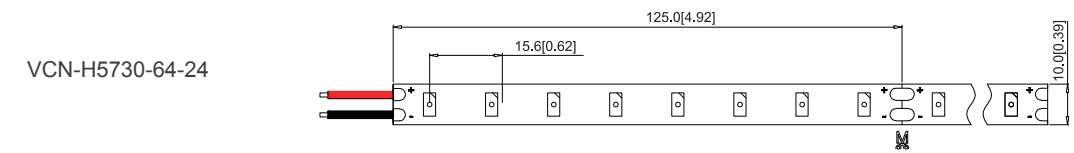

clip



VFN10MC

NOTE: Only show IP22 accessories list, Please refer to the accessories page for the list of other waterproof accessories

Joint



VFN-WC10CF2



VFN-WC10FF2



S10W1



S10W2

NOTE: Only show IP22 accessories list, Please refer to the accessories page for the list of other waterproof accessories

Aluminum Profile

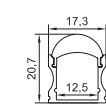

SL172012-A

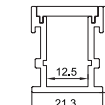

SL212612-A

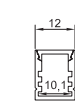

SL121510-A

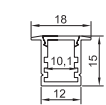

SL181510-A

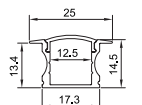

SL251512-A

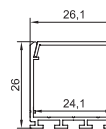

SL262624-A

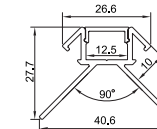

SL412812-A

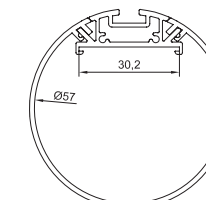

XT606030-A

NOTE: Only some common profiles are displayed, please refer to the list of specific profiles for the rest

CURRENT REGULATOR HIGH EFFICACY SERIES

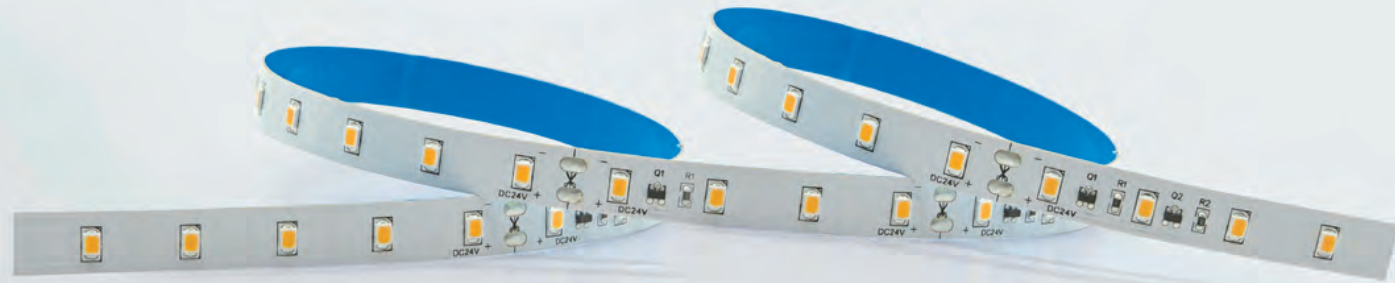
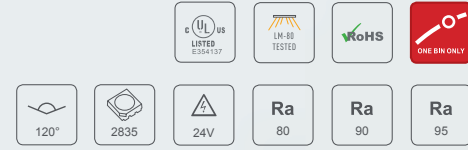

DC 24V **5** yrs warranty

Color Available



IP22(N)	IP64(WP)	IP65(WS)	IP67(WT)	IP68(WHE)	IP68(WE)	IP68(WTS/WTU)

Optical & Electrical Parameters

Model No.	Light Color	Color Temperature(K)	Luminous Flux(lm/m)	CRI/Ra	Efficacy(lm/W)	Power(W/m)
VCN-H2835-64-24	W	1900-9000	968-1065	80+	126-138	7.68
VCN-H2835-128-24	W	1900-9000	1498-1698	80+	130-147	11.52
VCN-H2835-160-24	W	1900-9000	1872-2088	80+	130-145	14.4
VCN-H2835-240-24	W	1900-9000	2700-3024	80+	125-140	21.6

Other Parameters

Model No.	LED Quantity(pcs/m)	Max Run(m/inch)	Min Cuttable Length (mm/inch)	Standard Packing Size/Reel L*W(mm/inch)
VCN-H2835-64-24	64	9.5[374.01]	125.0[4.92]	5000X10[196.85X0.39]
VCN-H2835-128-24	128	7.0[275.59]	62.5[2.46]	5000X10[196.85X0.39]
VCN-H2835-160-24	160	5.5[216.53]	50.0[1.97]	5000X10[196.85X0.39]
VCN-H2835-240-24	240	7.0[275.59]	33.33[1.31]	5000X14[196.85X0.55]

Profile Drawings

Length Unit : mm/inch

VCN-H2835-64-24

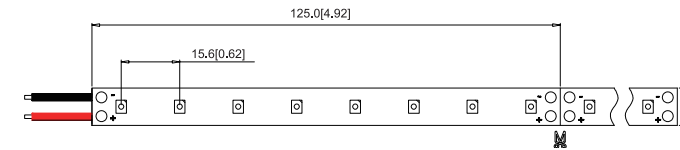

CN-H2835-160-24

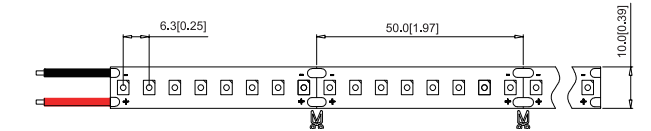

VCN-H2835-128-24

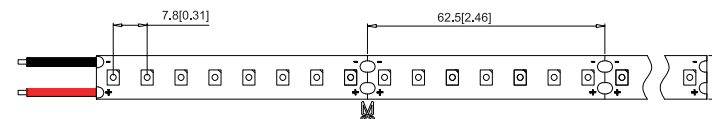

CN-H2835-240-24

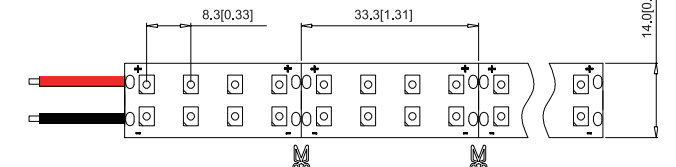

clip



VFN10MC

NOTE: Only show IP22 accessories list, Please refer to the accessories page for the list of other waterproof accessories

Joint



VFN-WC10CF2



VFN-WC10FF2



S10W1



S10W2

NOTE: Only show IP22 accessories list, Please refer to the accessories page for the list of other waterproof accessories

Aluminum Profile

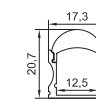

SL172012-A

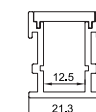

SL212612-A

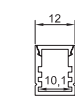

SL121510-A

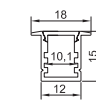

SL181510-A

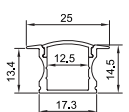

SL251512-A

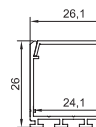

SL262624-A

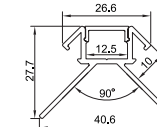

SL412812-A

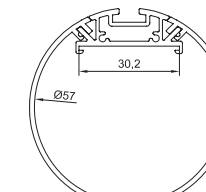

XT606030-A

NOTE: Only some common profiles are displayed, please refer to the list of specific profiles for the rest

HIGH EFFICACY SERIES

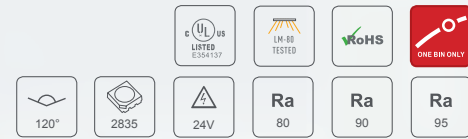

DC 24V **5** yrs warranty

Color Available

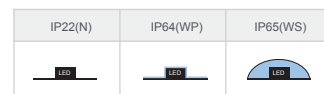

Optical & Electrical Parameters

Model No.	Light Color	Color Temperature(K)	Luminous Flux(lm/m)	CRI/Ra	Efficacy(lm/W)	Power(W/m)
VFN-H2835-288-24	W	1900-9000	3240-3681	80+	125-142	25.92
VFN-H2835-416-24	W	1900-9000	4755-5391	80+	127-144	37.44
VFN-H2835-432-24	W	1900-9000	4860-5521	80+	125-142	38.88

Other Parameters

Model No.	LED Quantity(pcs/m)	Max Run(m/inch)	Min Cuttable Length (mm/inch)	Standard Packing Size/Reel L*W(mm/inch)
VFN-H2835-288-24	288	4.5	83.3[3.28]	5000X14[196.85X0.87]
VFN-H2835-416-24	416	6.5	38.5[1.51]	5000X50[196.85X1.97]
VFN-H2835-432-24	432	5	18.5[0.73]	5000X28[196.85X1.10]

Profile Drawings

Length Unit : mm/inch

VFN-H2835-288-24

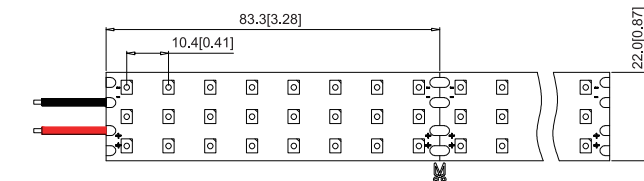

VFN-H2835-416-24

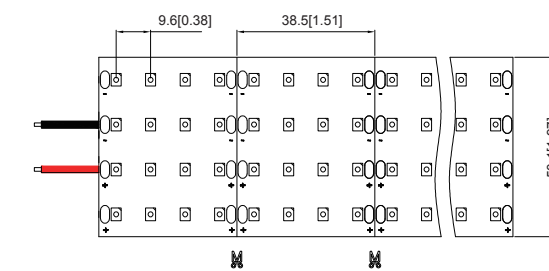

VFN-H2835-432-24

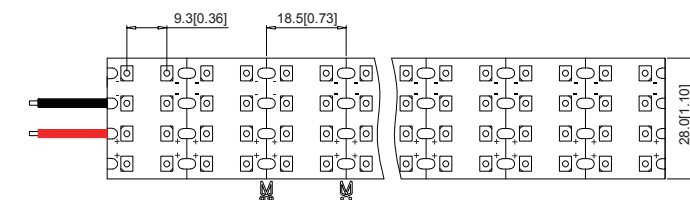

Aluminum Profile

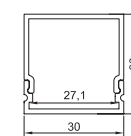

SL303027-A

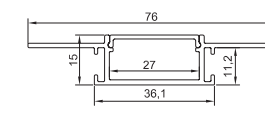

SL761527-A

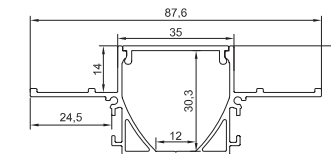

XT883312-A

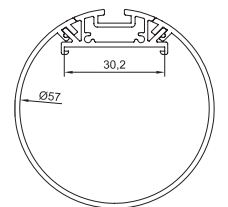

XT606030-A

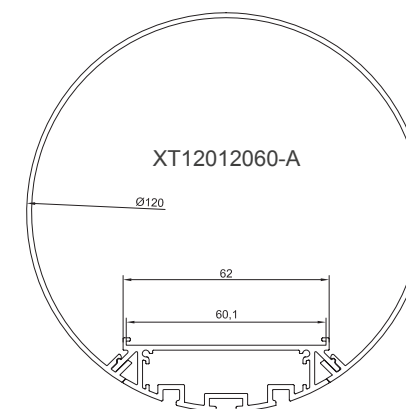

NOTE: Only some common profiles are displayed, please refer to the list of specific profiles for the rest

CURRENT REGULATOR SERIES

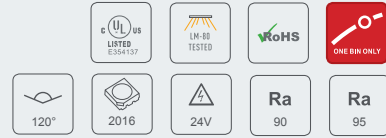

DC 24V **5** yrs warranty

Color Available



IP22(N)	IP64(WP)	IP65(WS)	IP67(WT)

Optical & Electrical Parameters

Model No.	Light Color	Color Temperature(K)	Luminous Flux(lm/m)	CRI/Ra	Efficacy(lm/W)	Power(W/m)
VCN-2016A-180-24	W	1900-100000	972-1188	90+	83	12.96

Other Parameters

Model No.	LED Quantity(pcs/m)	Max Run(m/inch)	Min Cuttable Length (mm/inch)	Standard Packing Size/Reel L*W(mm/inch)
VCN-2016A-180-24	180	5.0[196.85]	33.3[1.31]	5000X10[196.85X0.39]

Profile Drawings

Length Unit : mm/inch

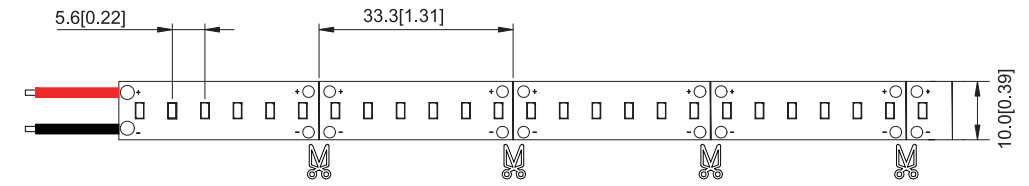

clip



VFN10MC

NOTE: Only show IP22 accessories list, Please refer to the accessories page for the list of other waterproof accessories

Joint



VFN-WC10CF2

VFN-WC10FF2

S10W1

S10W2

NOTE: Only show IP22 accessories list, Please refer to the accessories page for the list of other waterproof accessories

Aluminum Profile



SL191911-A



SL221211-A



SL161610-B



SL161610-A



SL121510-A



SL181510-A

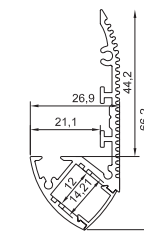

XT662712-A



SL150611-A

NOTE: Only some common profiles are displayed, please refer to the list of specific profiles for the rest

MINI SERIES



Luminous letter, signage, general lighting, etc.



MINI SERIES-5MM



DC 24V **5** yrs warranty

Color Available



Optical & Electrical Parameters

Model No.	Input Voltage	Color Temperature(K)	Luminous Flux(lm/m)	CRI/Ra	Efficacy(lm/W)	Power(W/m)
VMN-2835A-60-12/24	12/24V	1900-9000	456-478	80+	95-100	4.8
VMN-2835A-90-12	12V	1900-9000	684-718	80+	95-100	7.2

Other Parameters

Model No.	LED Quantity(pcs/m)	Max Run(m/inch)	Min Cuttable Length (mm/inch)	Standard Packing Size/Reel L*W(mm/inch)
VMN-2835A-60-12	60	3.0[118.11]	50[1.97]	5000X5[196.85X0.20]
VMN-2835A-60-24	60	5.0[196.85]	100[3.94]	5000X5[196.85X0.20]
VMN-2835A-90-12	90	2.5[98.42]	33.3[1.31]	5000X5[196.85X0.20]

Profile Drawings

Length Unit : mm/inch

VMN-2835A-60-12

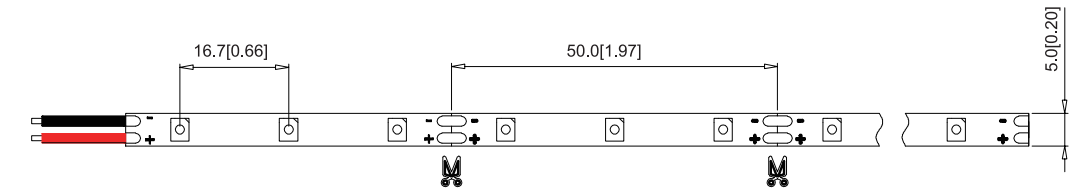

VMN-2835A-60-24

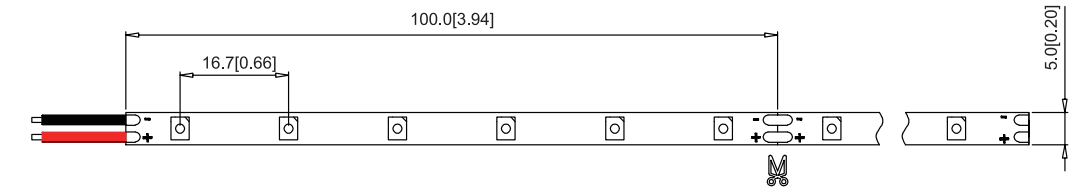

VMN-2835A-90-12

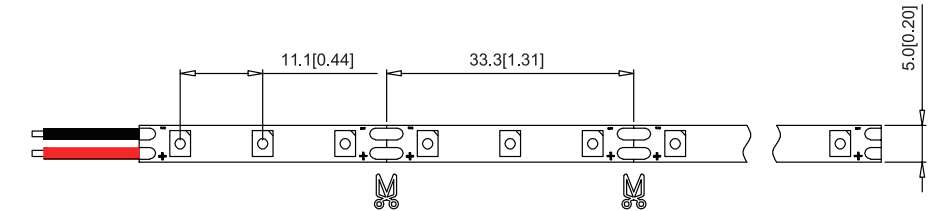

clip



VFN08MC

NOTE: Only show IP22 accessories list, Please refer to the accessories page for the list of other waterproof accessories

Aluminum Profile



SL080805-A



SL101508-A



SL101008-A

NOTE: Only some common profiles are displayed, please refer to the list of specific profiles for the rest

MINI SERIES-4MM



DC 12/24V **5** yrs warranty

Color Available

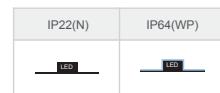

Optical & Electrical Parameters

Model No.	Input Voltage	Color Temperature(K)	Luminous Flux(lm/m)	CRI/Ra	Efficacy(lm/W)	Power(W/m)
VMN-2835A-120-12	12V	1900-9000	912-956	80+	95-100	9.6
VMN-2835A-120-24	24V	1900-9000	912-956	80+	95-100	9.6

Other Parameters

Model No.	LED Quantity(pcs/m)	Max Run(m/inch)	Min Cuttable Length (mm/inch)	Standard Packing Size/Reel L*W(mm/inch)
VMN-2835A-120-12	120	1.5[59.05]	25.5[1.00]	5000X4[196.85X0.16]
VMN-2835A-120-24	120	3.0[118.11]	50.0[1.97]	5000X4[196.85X0.16]

Profile Drawings

Length Unit : mm/inch

VMN-2835A-120-12

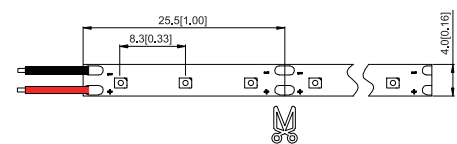

VMN-2835A-120-24

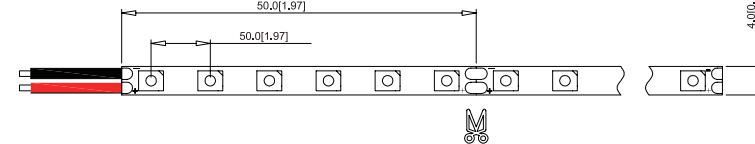

clip

Aluminum Profile



MINI SERIES



DC 24V **5** yrs warranty

Color Available



Optical & Electrical Parameters

Model No.	Input Voltage	Color Temperature(K)	Luminous Flux(lm/m)	CRI/Ra	Efficacy(lm/W)	Power(W/m)
VMN-2016A-182-24	12V	2700-6500	819-900	90+	87-96	9.36
VMN-5630A-60-24	24V	2700-6500	1710-1900	80+	60-66	28.8

Other Parameters

Model No.	LED Quantity(pcs/m)	Max Run(m/inch)	Min Cuttable Length (mm/inch)	Standard Packing Size/Reel L*W(mm/inch)
VMN-2016A-182-24	182	3.5[137.79]	38.46[1.51]	5000X5.0[196.85X0.20]
VMN-5630A-60-24	60	2.0[78.74]	100.0[3.93]	5000X6.5[196.85X0.26]

Profile Drawings

Length Unit : mm/inch

VMN-2016A-182-24

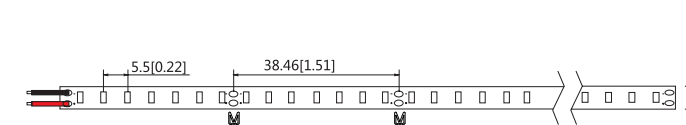

VMN-5630A-60-24

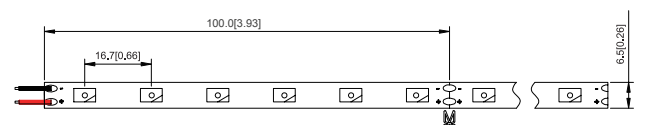

clip

Aluminum Profile

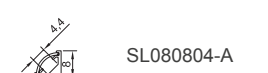
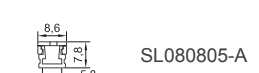

2016 LED
2835 LED
5050 LED



Luminous letter, signage, general lighting.

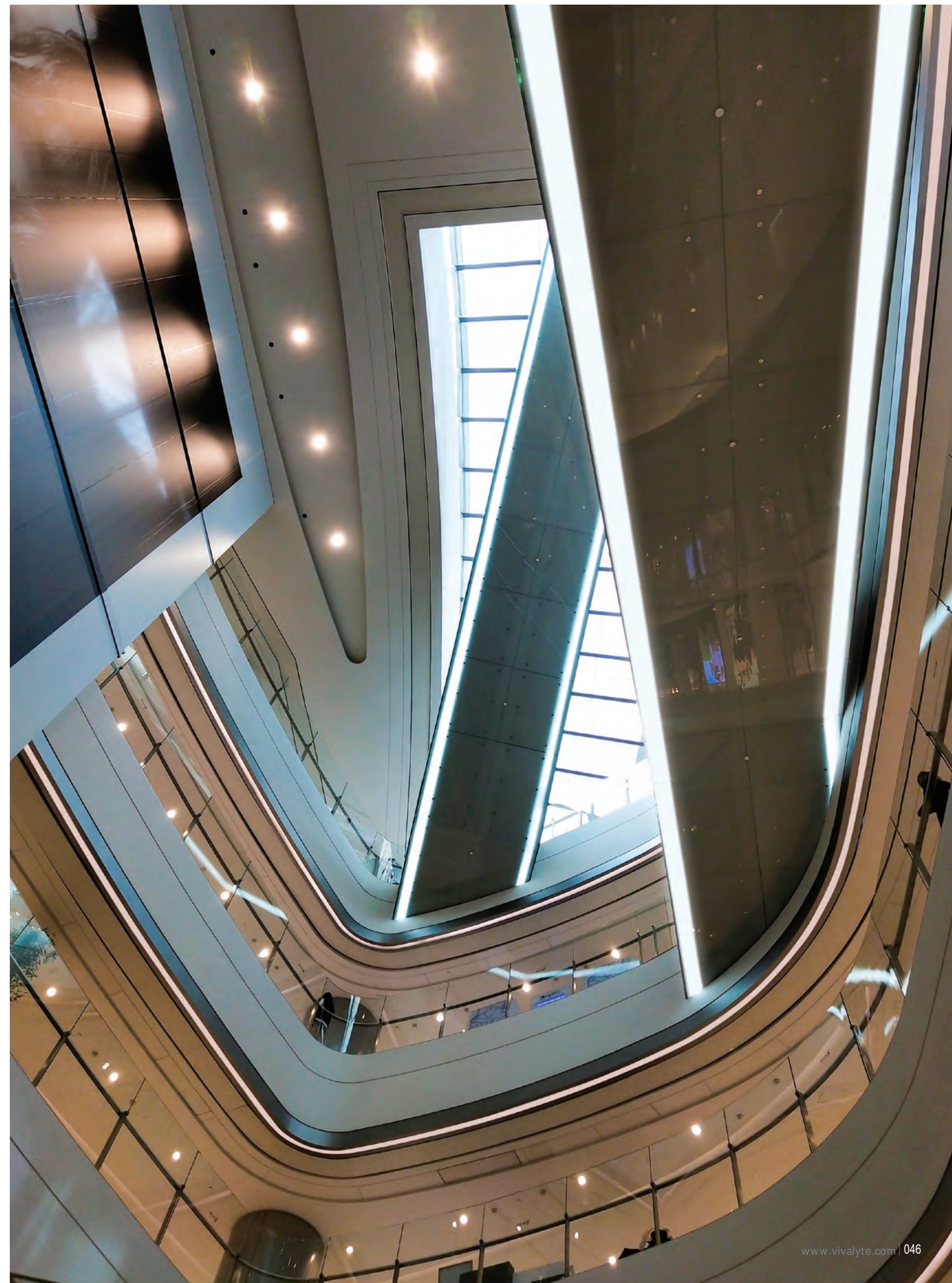

2016 LED SERIES

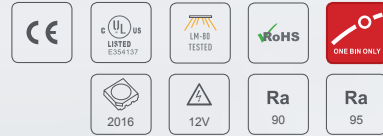

DC 24V **5 yrs warranty**

Color Available



IP22(N)	IP64(WP)	IP65(W5)	IP67(WT)	IP68(WHE)	IP68(WE)	IP68(WTS/WTU)

Optical & Electrical Parameters

Model No.	Input Voltage	Color Temperature(K)	Luminous Flux(lm/m)	CRI/Ra	Efficacy(lm/W)	Power(W/m)
VFN-2016A-240-24	24V	2700-6500	1200-1800	90+	70-104	17.28
VFN-2016A-266-24	24V	2700-6500	1436-1755	90+	62-91	16.42
VFN-2016B-294-24	24V	2700-6500	1296-1584	90+	85-104	15.12

Other Parameters

Model No.	LED Quantity(pcs/m)	Max Run(m/inch)	Min Cuttable Length (mm/inch)	Standard Packing Size/Reel L*W(mm/inch)
VFN-2016A-240-24	240	4.5[177.16]	25.0[0.98]	5000X10[196.85X0.39]
VFN-2016A-266-24	266	4.0[157.48]	26.3[1.04]	5000X10[196.85X0.39]
VFN-2016B-294-24	294	4.5[177.16]	23.8[0.94]	5000X10[196.85X0.39]

Profile Drawings

Length Unit : mm/inch

VFN-2016A-240-24

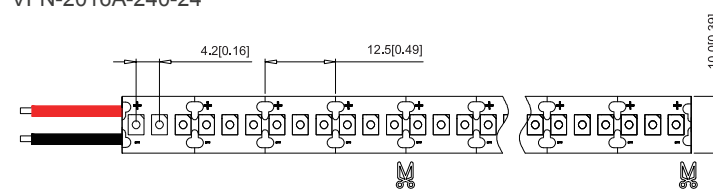

VFN-2016B-294-24

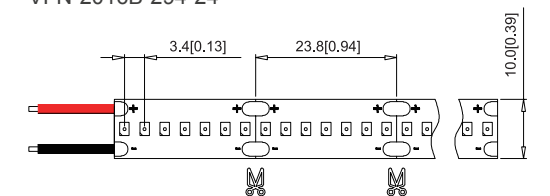

VFN-2016A-266-24

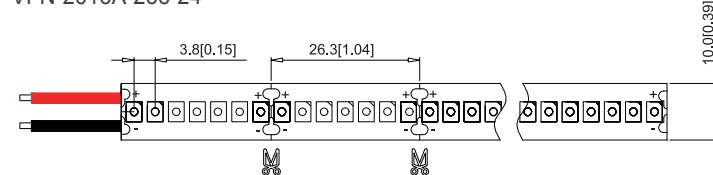

clip



VFN10MC

NOTE: Only show IP22 accessories list, Please refer to the accessories page for the list of other waterproof accessories

Joint



NOTE: Only show IP22 accessories list, Please refer to the accessories page for the list of other waterproof accessories

Aluminum Profile



NOTE: Only some common profiles are displayed, please refer to the list of specific profiles for the rest

2835 LED SERIES



DC 12/24V **5** yrs warranty

Color Available



IP22(N)	IP64(WP)	IP65(WS)	IP67(WT)	IP68(WHE)	IP68(WE)	IP68(WTS/WTU)

NOTE: For FN-2835A-432-24, the IP grade only IP22, IP64, IP65.

Optical & Electrical Parameters

Model No.	Input Voltage	Color Temperature(K)	Luminous Flux(lm/m)	CRI/Ra	Efficacy(lm/W)	Power(W/m)
VFN-2835A-30-12/24	12/24	1900-9000	612-642	80+	85-90	7.2
VFN-2835A-60-12/24	12/24	1900-9000	1224-1285	80+	85-90	14.4
VFN-2835A-120-12/24	12/24	1900-9000	1324-1390	80+	91-96	14.4
VFN-2835A-240-12/24	12/24	1900-9000	2440-2592	80+	84-90	28.8
VFN-2835A-432-24	24	1900-9000	4354-4572	80+	84-88	51.8

Other Parameters

Model No.	LED Quantity (pcs/m)	Max Run(m/inch)	Min Cuttable Length (mm/inch)	Standard Packing Size/Reel L*W(mm/inch)
VFN-2835A-30-12/24	30	7[275.59] / 12[472.44]	100[3.94] / 200[7.87]	5000X10[196.85X0.39]
VFN-2835A-60-12/24	60	4.5[177.16] / 8[314.96]	50[1.97] / 100[3.94]	5000X10[196.85X0.39]
VFN-2835A-120-12/24	120	4.5[177.16] / 8[314.96]	25[0.98] / 50[1.97]	5000X10[196.85X0.39]
VFN-2835A-240-12/24	240	3[118.11]/5[196.85]	25[0.98]	5000X14[196.85X0.55]
VFN-2835A-432-24	432	4.0[157.48]	55.6[2.19]	5000X28[196.85X1.10]

Profile Drawings

Length Unit : mm/inch

VFN-2835A-30-12

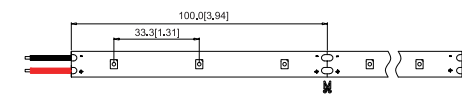

VFN-2835A-30-24

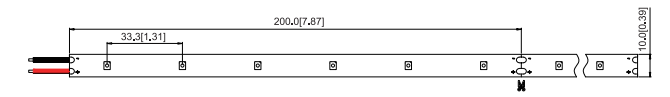

VFN-2835A-60-12

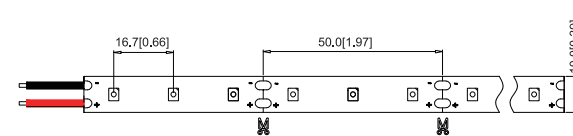

VFN-2835A-60-24

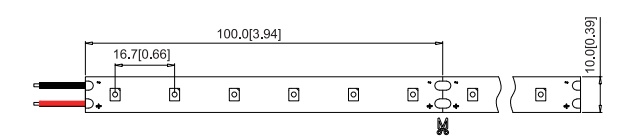

VFN-2835A-120-12

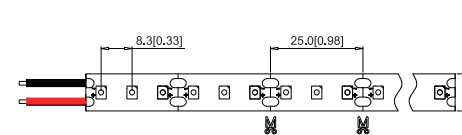

VFN-2835A-120-24

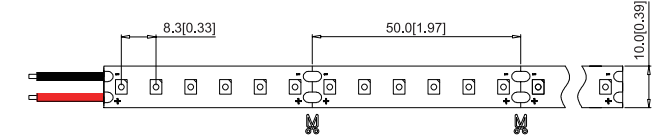

VFN-2835A-240-12/24

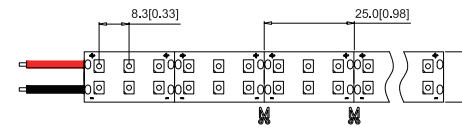

VFN-2835A-432-24

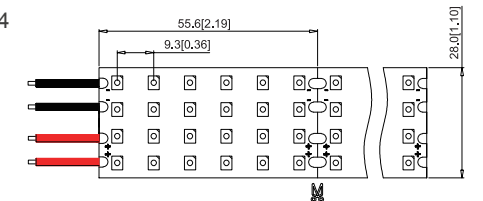

clip



VFN08MC VFN10MC VFWS08MC VFWS10MC

NOTE: Only show IP22 accessories list, Please refer to the accessories page for the list of other waterproof accessories

Joint



VFN-W8FF2 VFWS-W8FF2 VFN-W10FF2 VFWS-W10FF2 S8W1 S10W1 S8W2



S10W2

NOTE: Only show IP22 accessories list, Please refer to the accessories page for the list of other waterproof accessories

Aluminum Profile

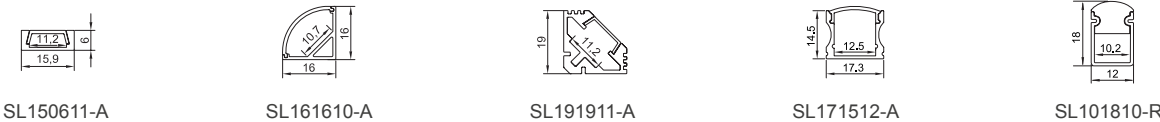

SL150611-A SL161610-A SL191911-A SL171512-A SL101810-R

NOTE: Only some common profiles are displayed, please refer to the list of specific profiles for the rest

3528 LED SERIES

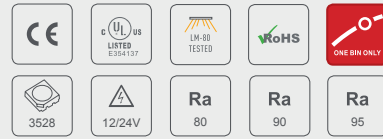

DC 12/24V 5 yrs warranty

Color Available



Optical & Electrical Parameters

Model No.	Input Voltage	Color Temperature(K)	Luminous Flux(lm/m)	CRI/Ra	Power(W/m)
VFN-3528A-60-12/24	12/24	3000-9000	420-480	80+	4.8
VFN-3528A-120-12/24	12/24	3000-9000	840-960	80+	9.6
VFN-3528A-240-12/24	12/24	3000-9000	1680-1920	80+	19.2

Other Parameters

Model No.	LED Quantity (pcs/m)	Max Run(m/inch)	Min Cuttable Length (mm/inch)	Standard Packing Size/Reel L*W(mm/inch)
VFN-3528A-60-12/24	60	4.5[177.16] / 6[236.22]	50[1.97] / 100[3.94]	5000X8[196.85X0.31]
VFN-3528A-120-12/24	120	2.5[98.42] / 4.0[157.48]	25[0.98] / 50[1.97]	5000X8[196.85X0.31]
VFN-3528A-240-12/24	240	2.5[98.42] / 4.0[157.48]	25[0.98] / 50[1.97]	5000X14[196.85X0.55]

Profile Drawings

Length Unit : mm/inch

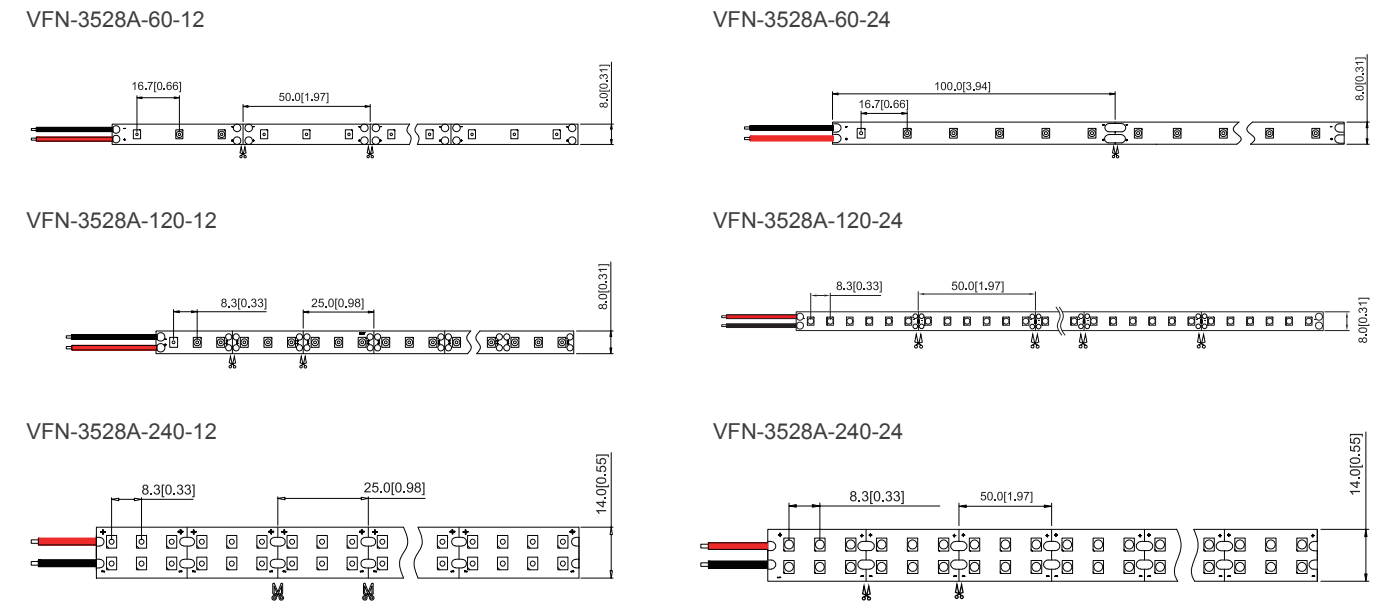

clip



VFN08MC

NOTE: Only show IP22 accessories list, Please refer to the accessories page for the list of other waterproof accessories

Joint



VFN-WC10CF2 VFN-WC10FF2 S10W1 S10W2 S10W0

NOTE: Only show IP22 accessories list, Please refer to the accessories page for the list of other waterproof accessories

Aluminum Profile

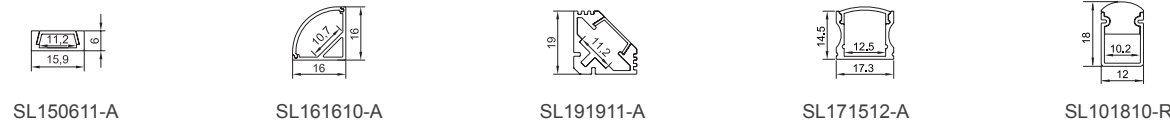

NOTE: Only some common profiles are displayed, please refer to the list of specific profiles for the rest

5050 LED SERIES

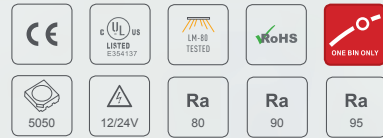

DC 12/24V **5** yrs warranty

Color Available



Optical & Electrical Parameters

Model No.	Input Voltage	Color Temperature(K)	Luminous Flux(lm/m)	CRI/Ra	Efficacy(lm/W)	Power(W/m)
VFN-5050A-30-12/24	12/24	2700-12000	540-660	80+	75-91	7.2
VFN-5050A-60-12/24	12/24	2700-12000	1080-1260	80+	75-87	14.4
VFN-5050A-120-12/24	12/24	2700-12000	2040-2400	80+	70-83	28.8

Other Parameters

Model No.	LED Quantity (pcs/m)	Max Run(m/inch)	Min Cuttable Length (mm/inch)	Standard Packing Size/Reel L*W(mm/inch)
VFN-5050A-30-12/24	30	3.5[137.79] / 5[196.85]	100[3.94] / 200[7.87]	5000X10[196.85X0.39]
VFN-5050A-60-12/24	60	2.5[98.42] / 4[157.48]	50[1.97] / 100[3.94]	5000X10[196.85X0.39]
VFN-5050A-120-12/24	120	2.5[98.42] / 4[157.48]	50[1.97]	5000X20[196.85X0.78]

Profile Drawings

Length Unit : mm/inch

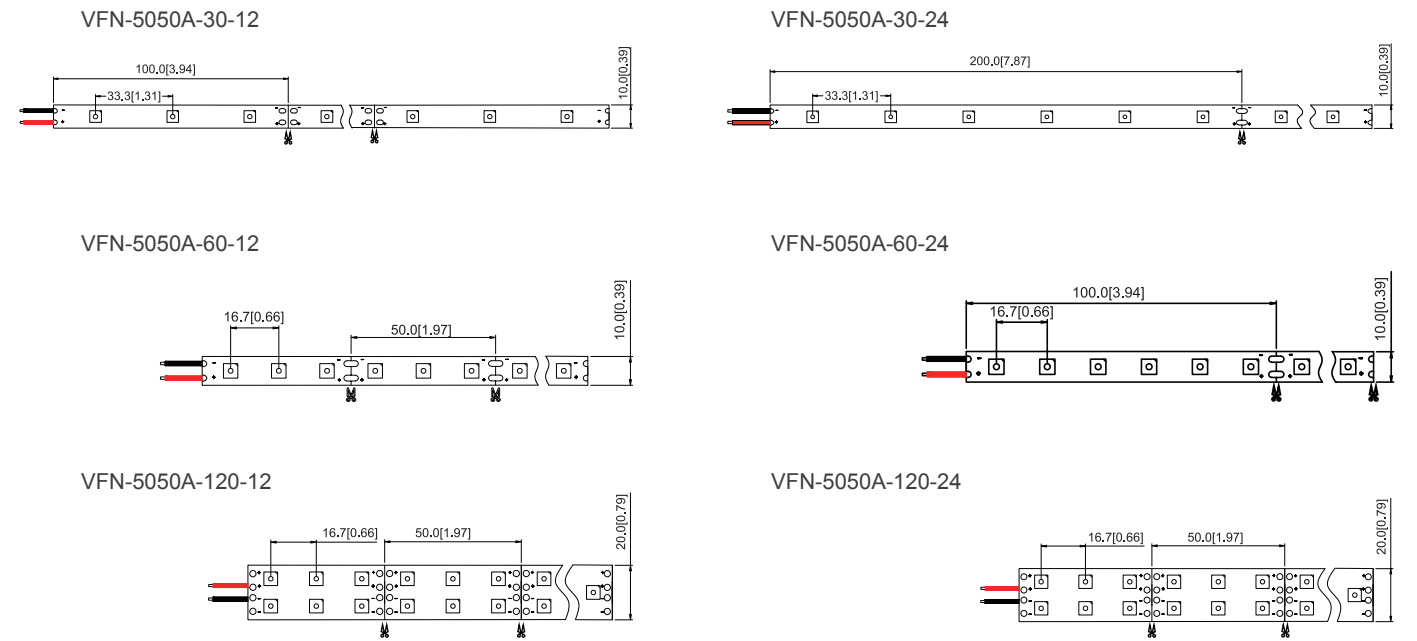

clip



VFN10MC

NOTE: Only show IP22 accessories list, Please refer to the accessories page for the list of other waterproof accessories

Joint



VFN-WC10CF2 VFN-WC10FF2 S10W1 S10W2 S10W0

NOTE: Only show IP22 accessories list, Please refer to the accessories page for the list of other waterproof accessories

Aluminum Profile



SL150611-A SL161610-A SL191911-A SL191911-A

NOTE: Only some common profiles are displayed, please refer to the list of specific profiles for the rest



CCT/COLOR CONTROLLABLE SERIES

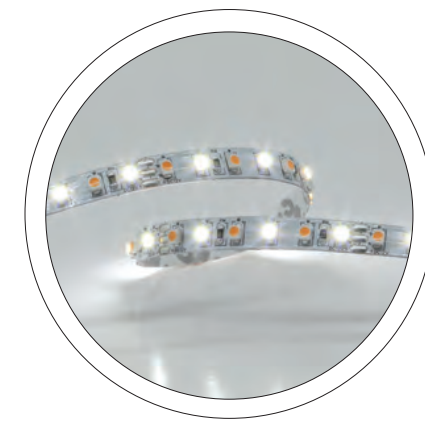

decorative lighting, cove lighting, etc.

CCT/COLOR CONTROLLABLE SERIES

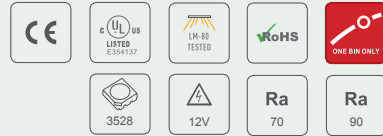

DC 12V **5 yrs warranty**

Color Available

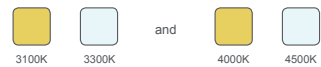

Optical & Electrical Parameters

Model No.	Light Color	Color Temperature(K)	Luminous Flux(lm/m)	CRI/Ra	Efficacy(lm/W)	Power(W/m)
VTN-T3528-120-12-WN	W	2700-3200	660-780	90+	68-81	9.6
	N	6000-6500	690-840	90+	71-87	9.6
	W+N	--	1320-1500	90+	68-78	19.2

Other Parameters

Model No.	LED Quantity(pcs/m)	Max Run(m/inch)	Min Cuttable Length (mm/inch)	Standard Packing Size/Reel L*W(mm/inch)
VTN-T3528-120-12-WN	120	1.5[59.05]	25.0[0.98]	5000X8[196.85X0.31]

Profile Drawings

Length Unit : mm/inch

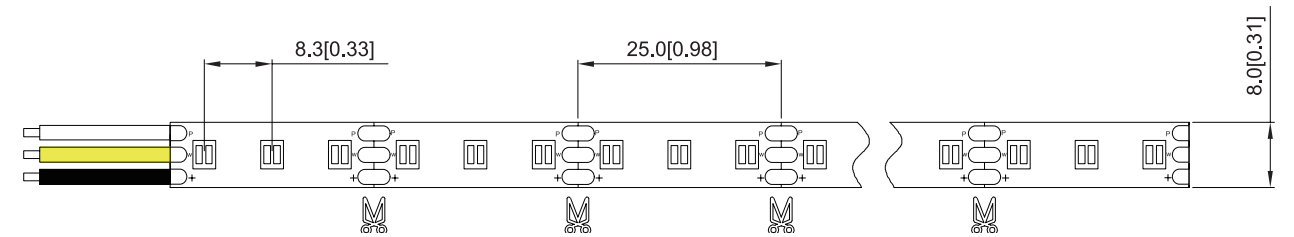

clip



VFN08MC

NOTE: Only show IP22 accessories list, Please refer to the accessories page for the list of other waterproof accessories

Aluminum Profile

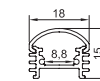

SL181508-A



SL101508-A



SL150611-A



SL101008-A



SL161610-A

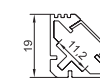

SL191911-A



SL171512-A

NOTE: Only some common profiles are displayed, please refer to the list of specific profiles for the rest

CCT/COLOR CONTROLLABLE SERIES

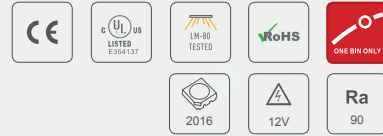

DC 12V **5** yrs warranty

Color Available



Optical & Electrical Parameters

Model No.	Light Color	Color Temperature(K)	Luminous Flux(lm/m)	CRI/Ra	Efficacy(lm/W)	Power(W/m)
VTN-2016A-180-12-WN	W	1800-3500	405-495	90+	62-76	6.48
	N	5000-9000	450-540	90+	69-83	6.48
	W+N	--	810-1015	90+	62-78	12.96
VTN-2016A-240-12/24-WN	W	1800-3500	540-660	90+	62-76	8.64
	N	5000-9000	600-720	90+	69-83	8.64
	W+N	--	1100-1350	90+	53-78	17.28

Other Parameters

Model No.	LED Quantity (pcs/m)	Max Run(m/inch)	Min Cuttable Length (mm/inch)	Standard Packing Size/Reel L*W(mm/inch)
VTN-2016A-180-12-WN	180	2.5[98.42]	33.3[1.31]	5000X10[196.85X0.39]
VTN-2016A-240-12/24-WN	240	2.5[98.42] / 3.5[137.79]	25[0.98] / 50[1.97]	5000X10[196.85X0.39]

Profile Drawings

Length Unit : mm/inch

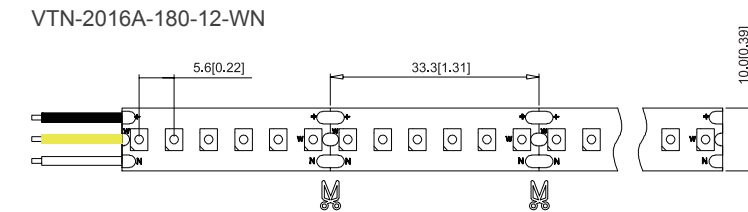

VTN-2016A-240-12-WN

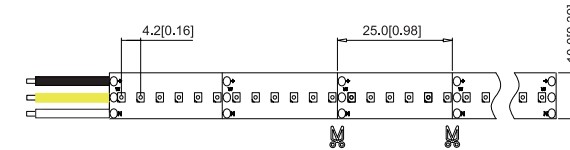

TN-2016A-240-24-WN

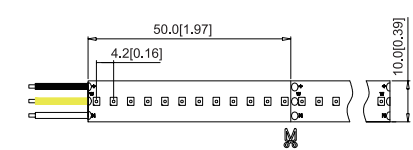

clip



VFN10MC

NOTE: Only show IP22 accessories list, Please refer to the accessories page for the list of other waterproof accessories

Joint



VFN-WC10CF2



VFN-WC10FF2



S10W1



S10W2



S10W0

NOTE: Only show IP22 accessories list, Please refer to the accessories page for the list of other waterproof accessories

Aluminum Profile



SL150611-A



SL161610-A



SL191911-A



SL191911-A

NOTE: Only some common profiles are displayed, please refer to the list of specific profiles for the rest

CCT/COLOR CONTROLLABLE SERIES



DC 12/24V **5** yrs warranty

Color Available

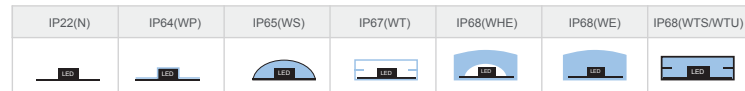

Optical & Electrical Parameters

Model No.	Light Color	Input Voltage(V)	Main wavelength(nm)	Luminous Flux(lm/m)	CRI/Ra	Power(W/m)
VTN-5050A-30-12/24-RGB	R	12/24V	620-625	60	--	2.4
	G		515-525	101		2.4
	B		460-470	24		2.4
	RGB		--	175		7.2
VTN-5050A-60-12/24-RGB	R	12/24V	620-625	125	--	4.8
	G		515-525	206		4.8
	B		460-470	48		4.8
	RGB		--	360		14.4

Other Parameters

Model No.	LED Quantity (pcs/m)	Max Run(m/inch)	Min Cuttable Length (mm/inch)	Standard Packing Size/Reel L*W(mm/inch)
VTN-5050A-30-12/24-RGB	30	4[157.48] / 5[196.85]	100[3.94] / 200[7.87]	5000X10[196.85X0.39]
VTN-5050A-60-12/24-RGB	60	2.5[98.42] / 3[118.11]	50[1.97] / 100[3.94]	5000X10[196.85X0.39]

Profile Drawings

Length Unit : mm/inch

VTN-5050A-30-12-RGB

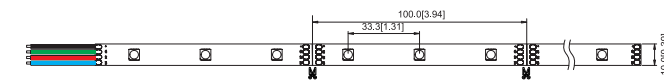

VTN-5050A-30-24-RGB

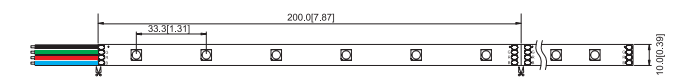

VTN-5050A-60-12-RGB

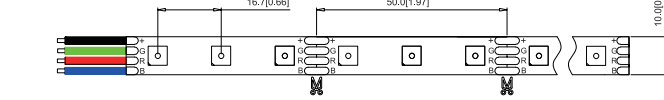

VTN-5050A-60-24-RGB

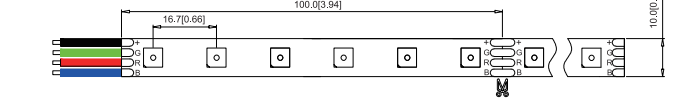

clip



FN10MC



FWS10MC

NOTE: Only show IP22 accessories list, Please refer to the accessories page for the list of other waterproof accessories

Joint



VFN-W10CF4



VFWS-W10CF4



VFWT-W10CFF4



VFN-W10FF4



VFWS-W10FF4



VFWT-W10FF4



RGB10W1



RGB10W2



RGB10W0

NOTE: Only show IP22 accessories list, Please refer to the accessories page for the list of other waterproof accessories

Aluminum Profile

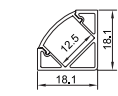

SL191911-C

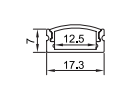

SL170712-A

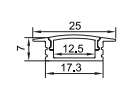

SL250712-A

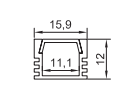

SL161210-A

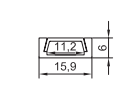

SL150611-A

NOTE: Only some common profiles are displayed, please refer to the list of specific profiles for the rest

CCT/COLOR CONTROLLABLE SERIES



DC 12/24V **4** yrs warranty

Color Available

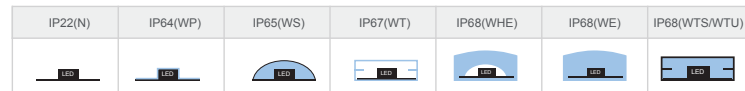

Optical & Electrical Parameters

Model No.	Light Color	Input Voltage(V)	Color Temperature(K) Main wavelength(nm)	Luminous Flux(lm/m)	CRI/Ra	Power(W/m)
VTN-F5050-60-12/24-RGBW	W	12/24	3000	370	90+	4.8
	R		620-625	117.6	--	4.8
	G		515-520	326	--	4.8
	B		460-470	52.8	--	4.8
	R+G+B		100000	396	--	14.4
	R+G+B+W		4700	921	--	19.2

Other Parameters

Model No.	LED Quantity (pcs/m)	Max Run(m/inch)	Min Cuttable Length (mm/inch)	Standard Packing Size/Reel L*W(mm/inch)
VTN-F5050-60-12-RGBW	60	2.5[98.42]	50[1.97]	5000X14[196.85X0.55]
VTN-F5050-60-24-RGBW	60	4.5[177.16]	100[3.94]	5000X14[196.85X0.55]

Profile Drawings

Length Unit : mm/inch

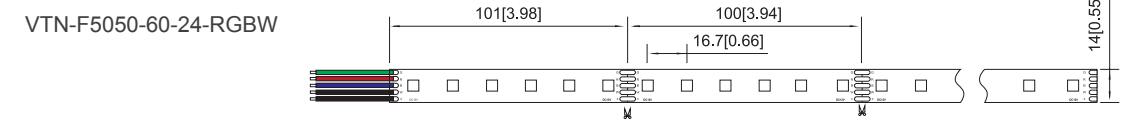
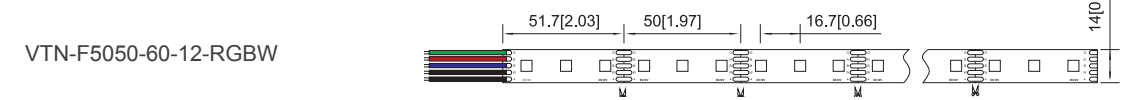

Joint



NOTE: Only show IP22 accessories list, Please refer to the accessories page for the list of other waterproof accessories

Aluminum Profile

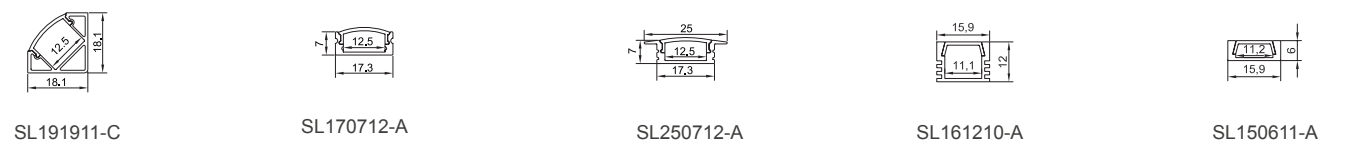

NOTE: Only some common profiles are displayed, please refer to the list of specific profiles for the rest

CCT/COLOR CONTROLLABLE SERIES

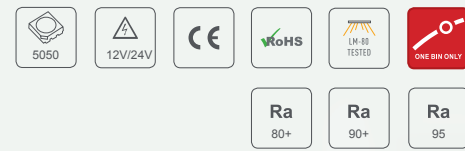

DC 12/24V **4** yrs warranty

Color Available

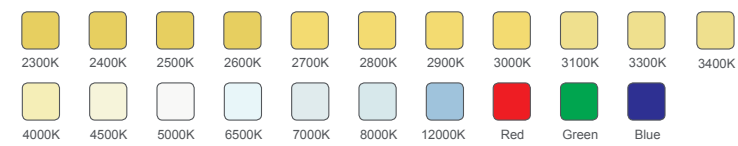

Optical & Electrical Parameters

Model No.	Light Color	Input Voltage(V)	Color Temperature(K) Main wavelength(nm)	Luminous Flux(lm/m)	CRI/Ra	Power(W/m)
VTN-5050A-60-12/24- RGB+W	R	12/24	620-630	60	--	2.4
	G		460-470	24	--	2.4
	B		515-530	101	--	2.4
	W		4000	107	80+	7.2
	RGB		--	175	--	7.2
	RGB+W		--	280	--	14.4

Other Parameters

Model No.	LED Quantity (pcs/m)	Max Run(m/inch)	Min Cuttable Length (mm/inch)	Standard Packing Size/Reel L*W(mm/inch)
VTN-5050A-60-12- RGB+W	60	3.0[118.11]	100[3.94]	5000X14[196.85X0.55]
VTN-5050A-60-24- RGB+W	60	5.0[196.85]	200[7.87]	5000X14[196.85X0.55]

Profile Drawings

Length Unit : mm/inch

VTN-5050A-60-12-
RGB+W

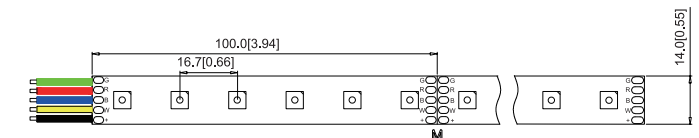

VTN-5050A-60-24-
RGB+W

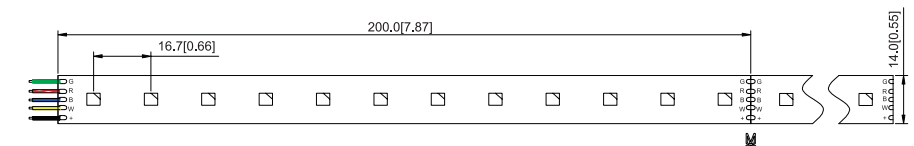

Joint



NOTE: Only show IP22 accessories list, Please refer to the accessories page for the list of other waterproof accessories

Aluminum Profile

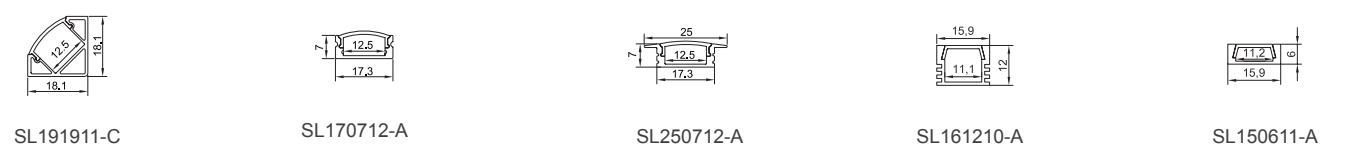

NOTE: Only some common profiles are displayed, please refer to the list of specific profiles for the rest

CCT/COLOR CONTROLLABLE SERIES

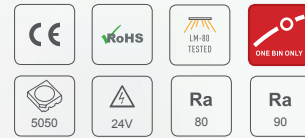

DC 24V **4 yrs warranty**

Color Available



Profile Drawings

Length Unit : mm/inch

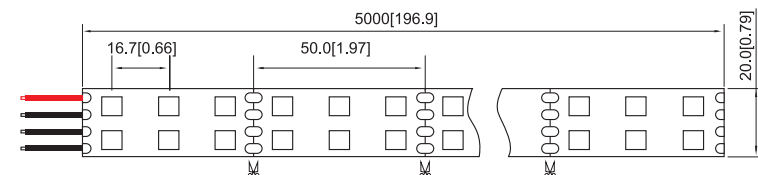

Optical & Electrical Parameters

Model No.	Light Color	Input Voltage(V)	Color Temperature(K) Main wavelength(nm)	Luminous Flux(lm/m)	CRI/Ra	Power(W/m)
VTN-5050A-120-24-RGB+W	R	24	620-625	172	--	4.8
	G		515-520	341	--	4.8
	B		460-470	80	--	4.8
	W		3000	590	80+	14.4
	RGB		--	1136	--	14.4
	RGB+W		--	1712	--	28.8

Other Parameters

Model No.	LED Quantity (pcs/m)	Max Run(m/inch)	Min Cuttable Length (mm/inch)	Standard Packing Size/Reel L*W(mm/inch)
VTN-5050A-120-24-RGB+W	120	4.0[157.48]	100[3.94]	5000X20[196.85X0.78]

Aluminum Profile

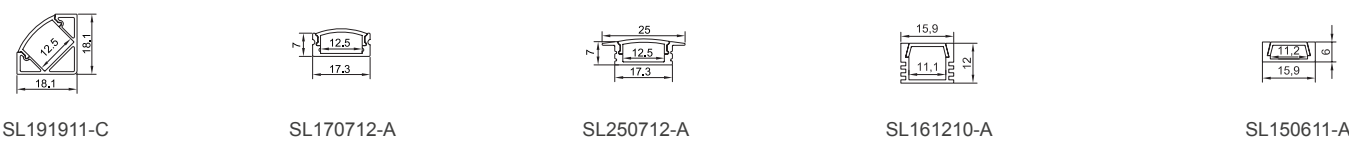

CCT/COLOR CONTROLLABLE SERIES



DC 24V **4 yrs warranty**

Color Available

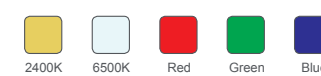

Profile Drawings

Length Unit : mm/inch

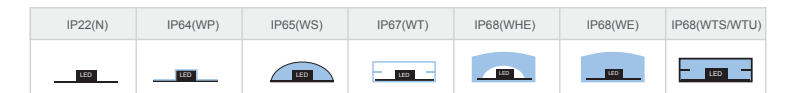
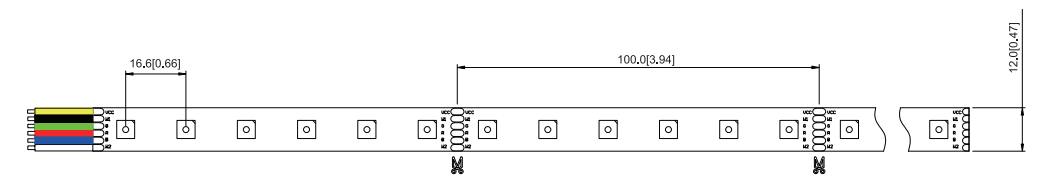

Optical & Electrical Parameters

Model No.	Light Color	Input Voltage(V)	Color Temperature(K) Main wavelength(nm)	Luminous Flux(lm/m)	CRI/Ra	Power(W/m)
VTN-S5050-60-24-RGBWN	R	24	615-625	82	--	2.4
	G		515-525	175	--	
	B		460-470	39	--	
	WW		2300-2600	193	80+	12.0
	NW		6500-7000	231	80+	
	RGBWN		--	690	--	

Other Parameters

Model No.	LED Quantity (pcs/m)	Max Run(m/inch)	Min Cuttable Length (mm/inch)	Standard Packing Size/Reel L*W(mm/inch)
VTN-S5050-60-24-RGBWN	60	3.5[137.79]	100[3.94]	5000X12[196.85X0.47]

clip



Aluminum Profile

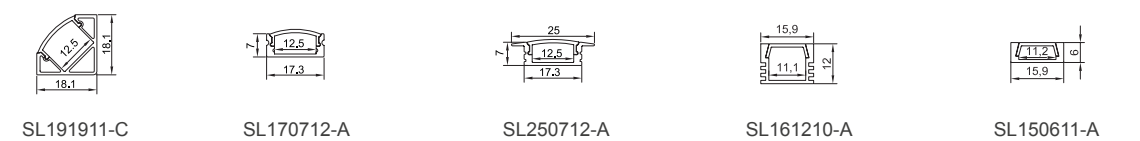

CCT/COLOR CONTROLLABLE SERIES

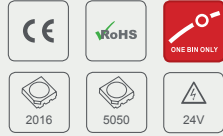

DC 24V **3 yrs warranty**

Color Available

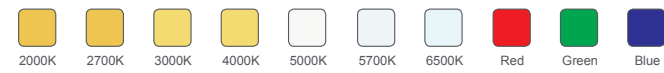

Optical & Electrical Parameters

Model No.	Light Color	Input Voltage(V)	Color Temperature(K)	Luminous Flux(lm/m)	CRI/Ra	Power(W/m)
VTN-S5050-180-24-RGB+WN	R	24	620-625	67	--	2.4
	G		515-520	118	--	2.4
	B		460-470	28	--	2.4
	WW		152	80+	2.4	
	NW		223	80+	2.4	

Other Parameters

Model No.	LED Quantity (pcs/m)	Max Run(m/inch)	Min Cuttable Length (mm/inch)	Standard Packing Size/Reel L*W(mm/inch)
VTN-S5050-180-24-RGB+WN	180	4[157.48]	100[3.94]	5000X14[196.85X0.55]

Profile Drawings

Length Unit : mm/inch

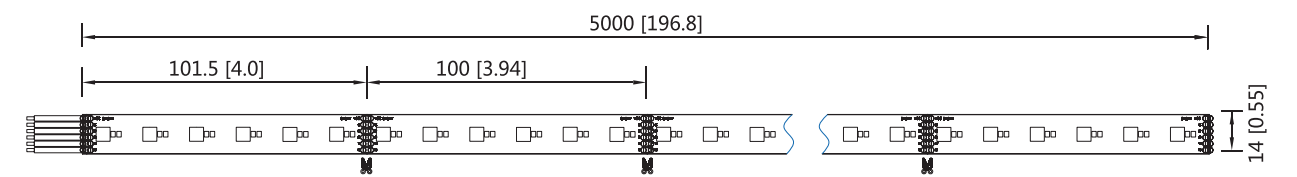

Aluminum Profile

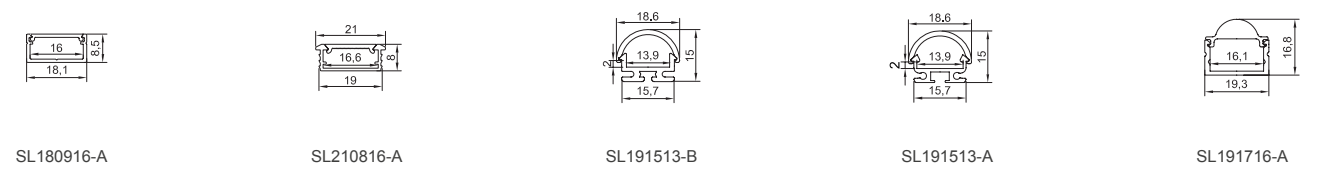

NOTE: Only some common profiles are displayed, please refer to the list of specific profiles for the rest

CCT/COLOR CONTROLLABLE SERIES

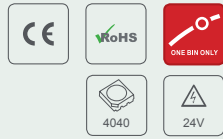

DC 24V **3** yrs warranty

Color Available

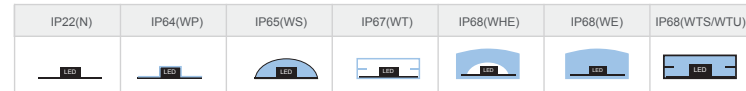
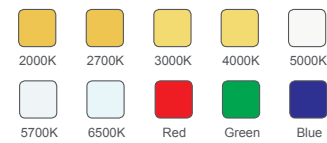

Optical & Electrical Parameters

Model No.	Light Color	Color Temperature/Wavelength(K/nm)	Luminous Flux(lm/m)	Efficacy(lm/W)	Power(W/m)
VTN-4040A-96-24-RGB	R	615-630	169	33	5.2
	G	515-530	307	60	5.2
	B	460-470	64	12.4	5.2
	RGB	10000	492	32	15.6
VTN-4040A-120-24-RGB	R	615-630	311	66	6.4
	G	515-530	384	60	6.4
	B	460-470	87	13.5	6.4
	RGB	10000	614	32	19.2

Other Parameters

Model No.	LED Quantity (pcs/m)	Max Run(m/inch)	Min Cuttable Length (mm/inch)	Standard Packing Size/Reel L*W(mm/inch)
VTN-4040A-96-24-RGB	96	3[118.1]	62.5[2.46]	5000X6[196.85X0.24]
VTN-4040A-120-24-RGB	120	4[157.4]	50.0[1.97]	5000X8[196.85X0.31]

Profile Drawings

Length Unit : mm/inch

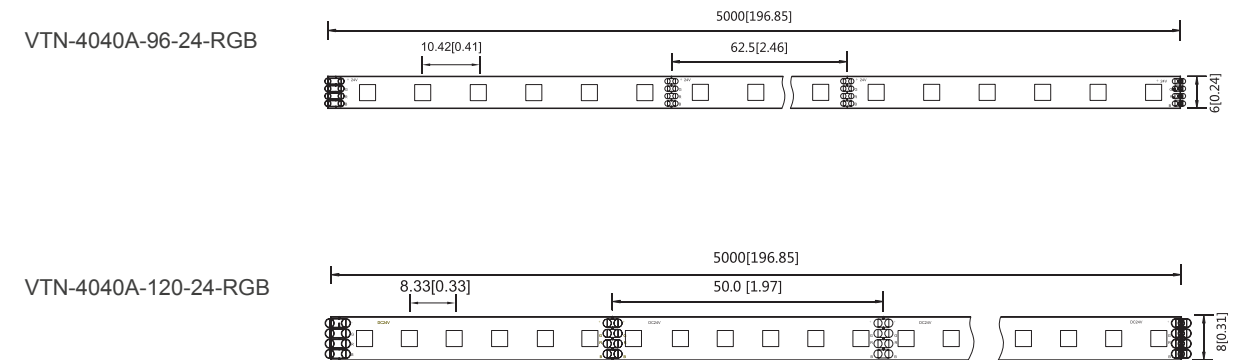

clip



VFN08MC

NOTE: Only show IP22 accessories list, Please refer to the accessories page for the list of other waterproof accessories

Aluminum Profile

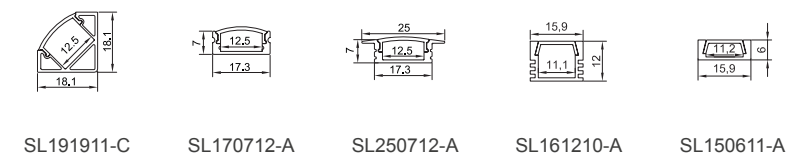

NOTE: Only some common profiles are displayed, please refer to the list of specific profiles for the rest

DIGITAL SERIES

Andscape lighting, decorative lighting and cove lighting.



DIGITAL SERIES

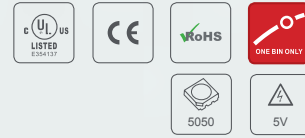

DC 5V **4 yrs warranty**

Color Available



IP22(N)	IP64(WP)	IP65(WS)	IP67(WT)	IP68(WHE)	IP68(WE)	IP68(WTS/WTU)

Optical & Electrical Parameters

Model No.	Light Color	Color Temperature/Wavelength(K/nm)	Luminous Flux(lm/m)	Efficacy(lm/W)	Power(W/m)
VDN-N5050-30-5-RGB	R	615-630	33	15	2.2
	G	515-530	79	36	2.2
	B	460-470	17	8	2.2
	R+G+B	10000	122	23	5.4
VDN-N5050-60-5-RGB	R	615-630	64	17	3.8
	G	515-530	150	41	3.8
	B	460-470	32	9	3.8
	R+G+B	10000	230	23	10.8

Other Parameters

Model No.	LED Quantity (pcs/m)	Max Run(m/inch)	Min Cuttable Length (mm/inch)	Standard Packing Size/Reel L*W(mm/inch)
VDN-N5050-30-5-RGB	30	4[157.48]	33.3[1.31]	5000X10[196.85X0.39]
VDN-N5050-60-5-RGB	60	2.5[98.42]	16.7[0.66]	5000X10[196.85X0.39]

Profile Drawings

Length Unit : mm/inch

VDN-N5050-30-5-RGB

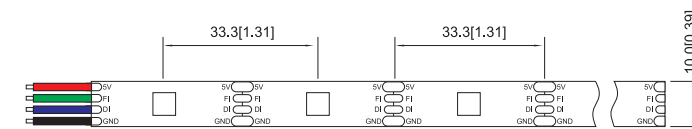

VDN-N5050-60-5-RGB

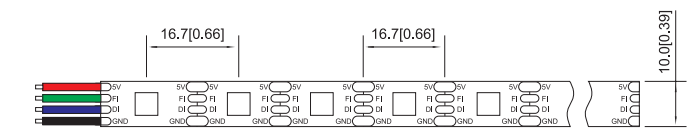

Digital Controller



VCS-BV-1000



VCS-BV-T1000



VCS-BV-502

Joint



VFN-W10CF4



VFWS-W10CF4



VFN-W10FF4



VFWS-W10FF4



VFWT-W10FF4



RGB10W1



RGB10W2

NOTE: Only show IP22 accessories list, Please refer to the accessories page for the list of other waterproof accessories

Aluminum Profile

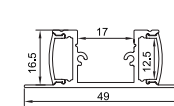

SL491712-A

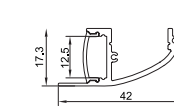

SL421712-A

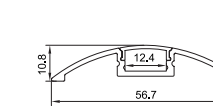

SL571012-A

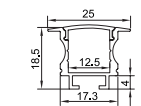

SL251912-A

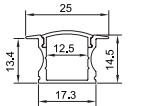

SL251512-A

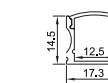

SL171512-A

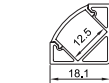

SL191911-C

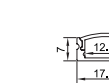

SL170712-A

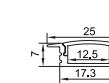

SL250712-A

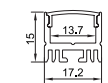

SL171513-A

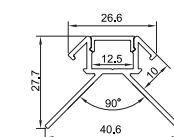

SL412812-A

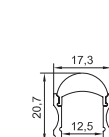

SL172012-A

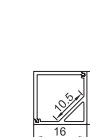

SL161610-B



SL161610-A

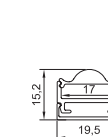

SL201517-A

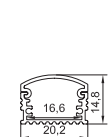

SL201516-A

NOTE: Only some common profiles are displayed, please refer to the list of specific profiles for the rest

DIGITAL SERIES

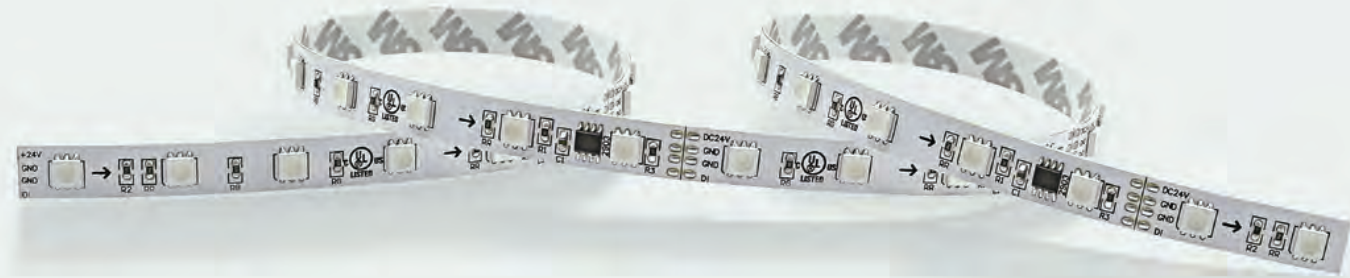
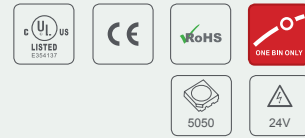

DC 12/24V **4** yrs warranty

Color Available

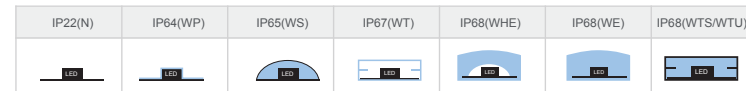

Optical & Electrical Parameters

Model No.	Light Color	Color Temperature/Wavelength(K/nm)	Luminous Flux(lm/m)	Efficacy(lm/W)	Power(W/m)
VDN-5050A-48-12/24- RGB/W	R	615-630	37.5	11.5	3.26
	G	515-530	18	5.5	3.26
	B	460-470	80	24.5	3.26
	R+G+B	100000+	196	789-930	9.79
	W	1900-9000	637-930	80-95	9.79

Other Parameters

Model No.	LED Quantity (pcs/m)	Max Run(m/inch)	Min Cuttable Length (mm/inch)	Standard Packing Size/Reel L*W(mm/inch)
VDN-5050A-48-12- RGB/W	48	3[118.11]	62.5[2.46]	5000X10[196.85X0.39]
VDN-5050A-48-24- RGB/W	48	5[196.85]	125.0[0.42]	5000X10[196.85X0.39]

Profile Drawings

Length Unit : mm/inch

VDN-5050A-48-12-
RGB/W

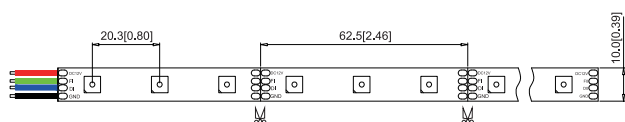

VDN-5050A-48-24-
RGB/W

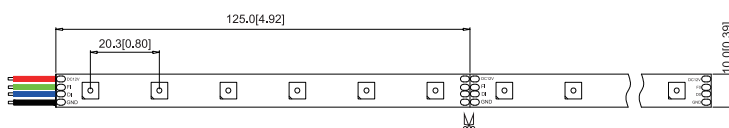

Smart Power Supply



VPSU-LPV-20 VPSU-LPV-35 VPSU-LPV-60 VPSU-LPV-100 VPSU-LPV-150 VPSU-LPVI-150

Indoor Power Supply



VPSU-BV-W36 VPSU-BV-W24 VPSU-BV-D60 VPSU-BV-D100

Digital Controller



VCS-BV-1000 VCS-BV-T1000 VCS-BV-502

Joint



VFN-W10CF4 VFWS-W10CF4 VFN-W10FF4 VFWS-W10FF4 RGB10W1 RGB10W2

NOTE: Only show IP22 accessories list, Please refer to the accessories page for the list of other waterproof accessories

Aluminum Profile

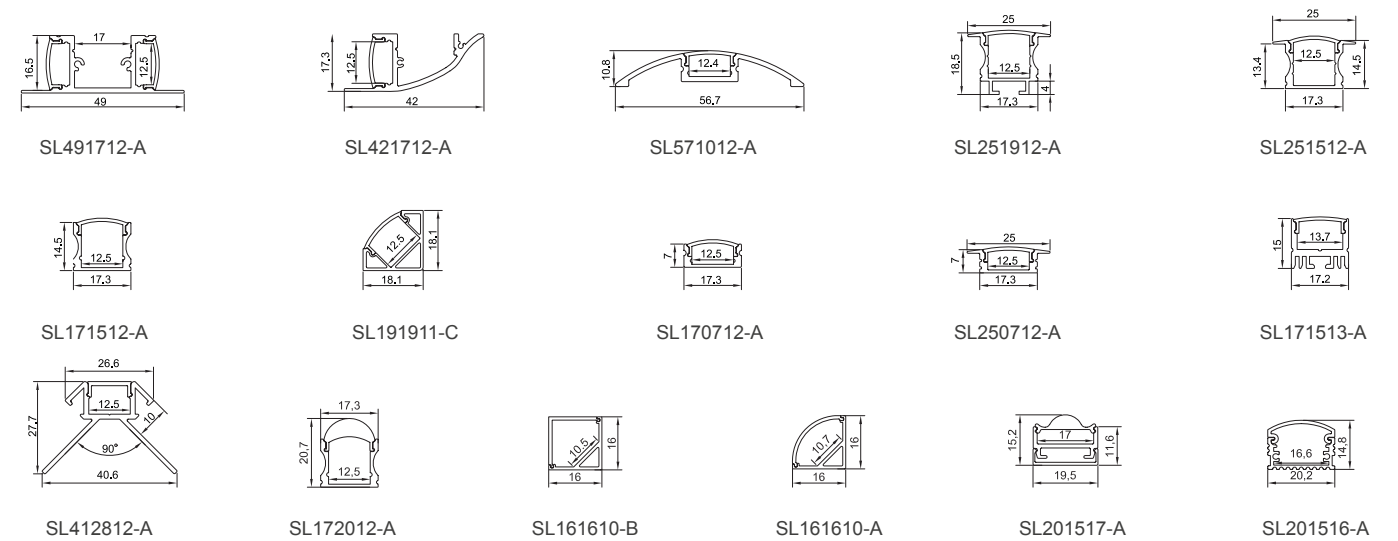

NOTE: Only some common profiles are displayed, please refer to the list of specific profiles for the rest

LINEAR STRIP
DIM TO WARM
SIDE EMITTING
SHORT CUTTABLE
CONSTANT CURRENT DRIVE



Landscape lighting, decorative lighting and cove lighting.



LINEAR

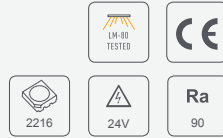

Color Available

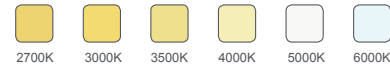

DC 24V **4** yrs warranty

Features

1. Adopt unique silica gel material great linear effect with no light spot,suitable for display lighting etc
2. Great linear effect for uniform light,different for traditional lighting product structure.
3. Small size,easy mounting for small characters.
4. Beam angle 120°
5. Multiple color temperture optional.
6. Working voltage DC24V.



Optical & Electrical Parameters

Model No.	Light Color	Color Temperature(K)	Typical Luminous Flux value(lm/m)	CRI/Ra	Efficacy(lm/W)	Power(W/m)
VFWSL2216-300-24-6	W	2700	682	90+	52	14.4
		6500	771		58	
VFWSL2216-300-24-10	W	2700	832	90+	48	14.4
		6500	964		55	

Other Parameters

Model No.	LED Quantity (pcs/m)	Max Run(m/inch)	Min Cuttable Length (mm/inch)	Standard Packing Size/Reel L*W(mm/inch)
VFWSL2216-300-24-6	300	5.5[216.53]	20[0.79]	5000X6[196.85X0.24]
VFWSL2216-300-24-10	300	4.5[177.16]	20[0.79]	5000X10[196.85X0.39]

Profile Drawings

Length Unit : mm/inch

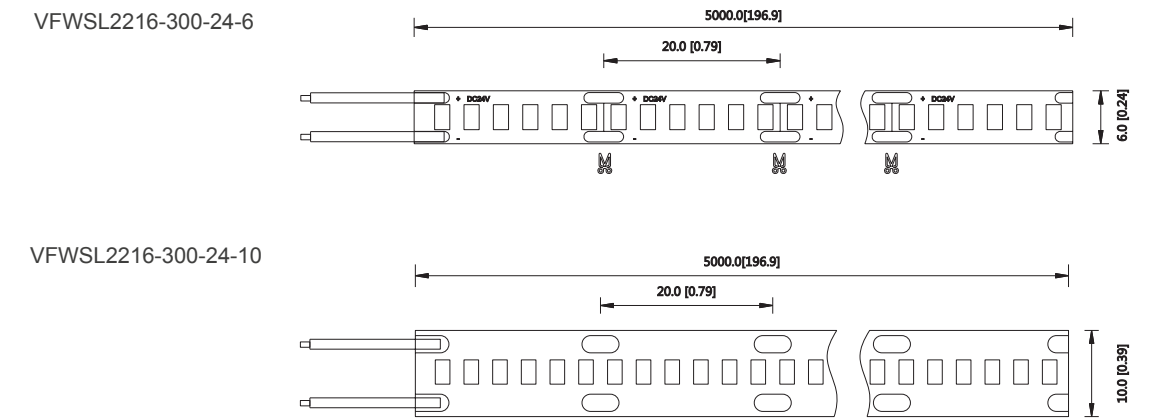

clip



VFWS08MC



VFWS10MC

NOTE: Only some common profiles are displayed,please refer to the list of specific profiles for the rest

Joint



VFWS-W10CF2



VFWS-W10FF2

NOTE: Only some common profiles are displayed, please refer to the list of specific profiles for the rest

DIM TO WARM SERIES

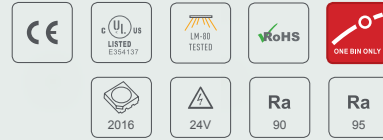

DC 24V **5** yrs warranty

Color Available

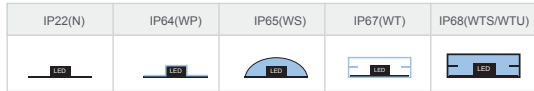

Optical & Electrical Parameters

Model No.	Light Color	Color Temperature(K)	Luminous Flux(lm/m)	CRI/Ra	Efficacy(lm/m)	Power(W/m)
VPTW-2016A-224-24-WN	W	2500-4500	1000	90+	--	10.8
VVTW-2016A-224-24-WN	W	2500-4500	1120	90+	--	10.8

Other Parameters

Model No.	LED Quantity (pcs/m)	Max Run(m/inch)	Min Cuttable Length (mm/inch)	Standard Packing Size/Reel L*W(mm/inch)
VPTW-2016A-224-24-WN	224	4[157.48]	62.5[2.46]	5000X12[196.85X0.47]
VVTW-2016A-224-24-WN	224	4[157.48]	71.4[2.81]	5000X12[196.85X0.47]

Profile Drawings

Length Unit : mm/inch

VPTW-2016A-224-24-WN

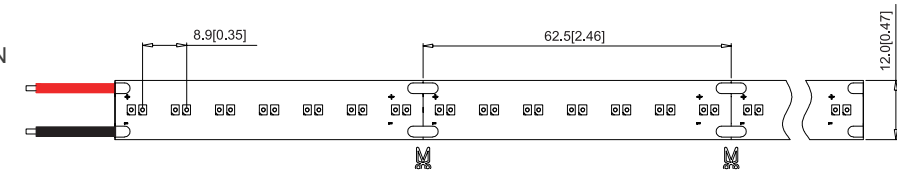

VVTW-2016A-224-24-WN

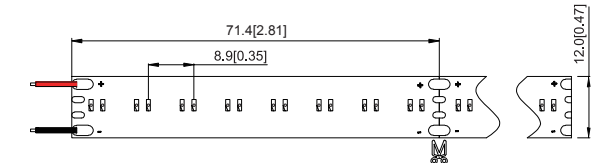

clip



VFN08MC

NOTE: Only show IP22 accessories list, Please refer to the accessories page for the list of other waterproof accessories

Joint



VFN-WC10CF2

VFN-WC10FF2

S10W1

S10W2

S10W0

NOTE: Only show IP22 accessories list, Please refer to the accessories page for the list of other waterproof accessories

Aluminum Profile



SL150611-A



SL161610-A

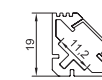

SL191911-A



SL171512-A



SL101810-R

NOTE: Only some common profiles are displayed, please refer to the list of specific profiles for the rest

SIDE EMITTING SERIES



DC 12V/24V **5** yrs warranty

Color Available

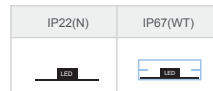

Optical & Electrical Parameters

Model No.	Light Color	Color Temperature(K)	Luminous Flux(lm/m)	CRI/Ra	Efficacy(lm/m)	Power(W/m)
VFN-3014A-60-12/24	W	2700-6500	367-403	80+	76-84	4.8

Other Parameters

Model No.	LED Quantity (pcs/m)	Max Run(m/inch)	Min Cuttable Length (mm/inch)	Standard Packing Size/Reel L*W(mm/inch)
VFN-3014A-60-12	60	3.0[118.11]	50[1.97]	5000X5[196.85X0.20]
VFN-3014A-60-24	60	3.5[137.79]	100[3.94]	5000X5[196.85X0.20]

Profile Drawings

Length Unit : mm/inch

VFN-3014A-60-12

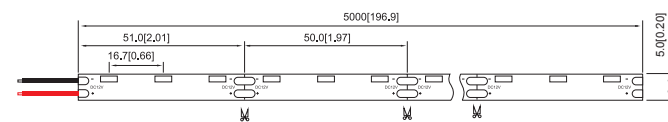

VFN-3014A-60-24

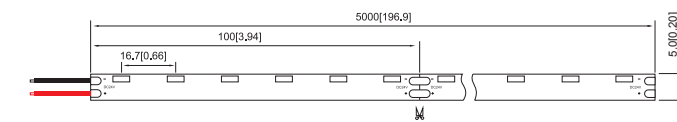

clip



VFN08MC

NOTE: Only show IP22 accessories list, Please refer to the accessories page for the list of other waterproof accessories

SIDE EMITTING SERIES



DC 12V/24V **5** yrs warranty

Color Available



Optical & Electrical Parameters

Model No.	Light Color	Color Temperature(K)	Luminous Flux(lm/m)	CRI/Ra	Efficacy(lm/m)	Power(W/m)
VFN-3014A-120-12/24	W	2700-6500	652-725	80+	68-75	9.6

Other Parameters

Model No.	LED Quantity (pcs/m)	Max Run(m/inch)	Min Cuttable Length (mm/inch)	Standard Packing Size/Reel L*W(mm/inch)
VFN-3014A-120-12	120	2.5[98.42]	25[0.98]	5000X8[196.85X0.20]
VFN-3014A-120-24	120	3[118.11]	50[1.96]	5000X8[196.85X0.20]

Profile Drawings

Length Unit : mm/inch

VFN-3014A-120-12

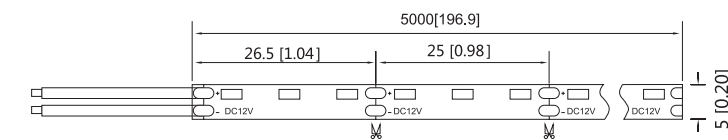

VFN-3014A-120-24

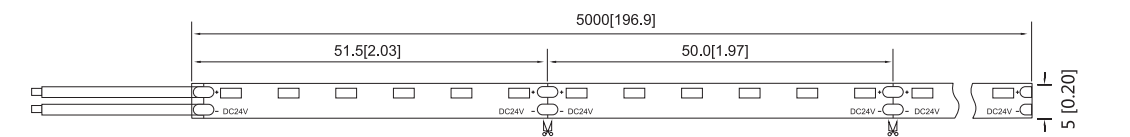

SHORT CUTTABLE SERIES



DC 12V/24V 5 yrs warranty

Color Available

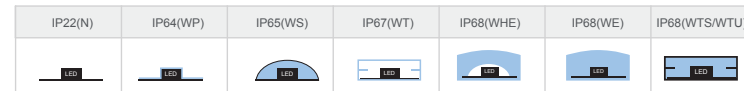

Optical & Electrical Parameters

Model No.	Light Color	Color Temperature(K)	Luminous Flux(lm/m)	Efficacy(lm/W)	CRI/Ra	Power(W/m)
VFN-F2835A-30-12	W	1900-9000	590-619	81-86	80+	7.2
VFN-F2835A-30-24	W	1900-9000	590-619	81-86	80+	7.2

Other Parameters

Model No.	LED Quantity (pcs/m)	Max Run(m/inch)	Min Cuttable Length (mm/inch)	Standard Packing Size/Reel L*W(mm/inch)
VFN-F2835A-30-12	30	7[275.59]	33.3[1.31]	5000X10[196.85X0.39]
VFN-F2835A-30-24	30	11[433.07]	67.7[2.67]	5000X10[196.85X0.39]

Profile Drawings

Length Unit : mm/inch

VFN-F2835A-30-12

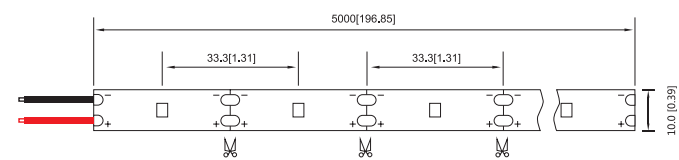

VFN-F2835A-30-24

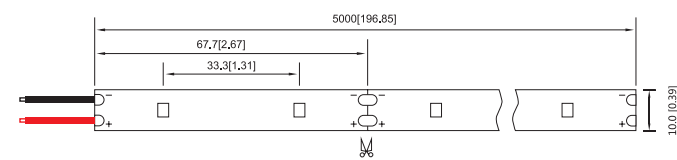

clip

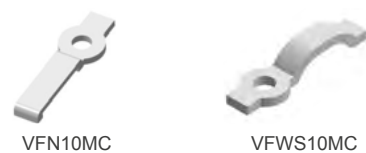

Joint



SHORT CUTTABLE SERIES

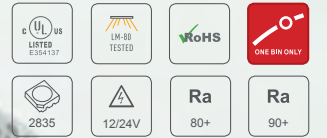

DC 12V/24V 5 yrs warranty

Color Available



Optical & Electrical Parameters

Model No.	Light Color	Color Temperature(K)	Luminous Flux(lm/m)	Efficacy(lm/W)	CRI/Ra	Power(W/m)
VFN-F2835A-60-24	W	1900-9000	1180-1239	81-86	80+	14.4

Other Parameters

Model No.	LED Quantity (pcs/m)	Max Run(m/inch)	Min Cuttable Length (mm/inch)	Standard Packing Size/Reel L*W(mm/inch)
VFN-F2835A-60-24	60	5.5[216.53]	33.3[1.31]	5000X10[196.85X0.39]

Profile Drawings

Length Unit : mm/inch

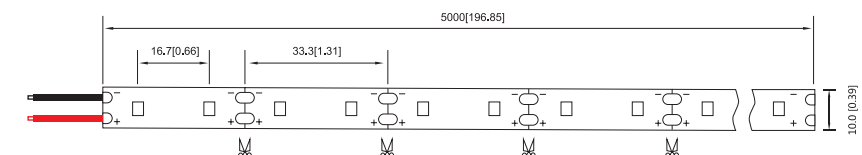

Joint



Aluminum Profile



SHORT CUTTABLE SERIES



DC 24V **5** yrs warranty

Color Available



IP22(N)	IP64(WP)	IP65(WS)	IP67(WT)	IP68(WHE)	IP68(WE)	IP68(WTS/WTU)

Optical & Electrical Parameters

Model No.	Light Color	Color Temperature(K)	Luminous Flux(lm/m)	CRI/Ra	Efficacy(lm/W)	Power(W/m)
VFN-F2835A-120-24	W	1900-9000	1831-1922	80+	84-89	21.6

Other Parameters

Model No.	LED Quantity (pcs/m)	Max Run(m/inch)	Min Cuttable Length (mm/inch)	Standard Packing Size/Reel L*W(mm/inch)
VFN-F2835A-120-24	120	3.5[137.79]	16.7[0.66]	5000X10[196.85X0.39]

Profile Drawings

Length Unit : mm/inch

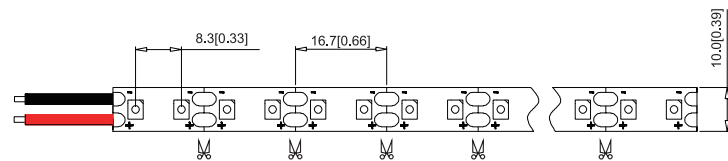

Joint



Aluminum Profile



CONSTANT CURRENT DRIVE SERIES

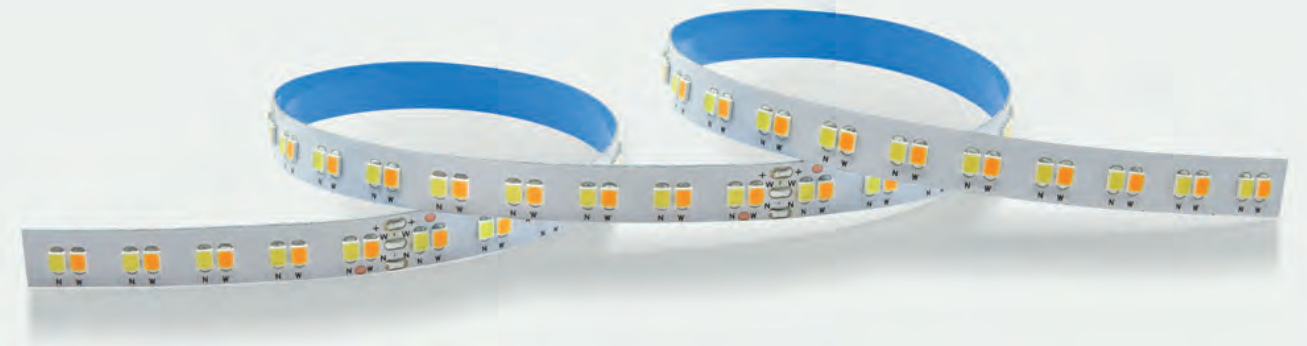
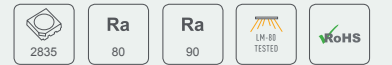

DC 30V/39V **5** yrs warranty

Color Available



IP22(N)	IP64(WP)	IP65(WS)	IP67(WT)	IP68(WHE)	IP68(WE)	IP68(WTS/WTU)

Optical & Electrical Parameters

Model No.	Light Color	Color Temperature/ Wavelength(K/nm)	Luminous Flux (lm/m)	CRI/Ra	Efficacy (lm/W)	Input Voltage (V/DC)	Power(W/m)
VTCCN-H2835-168-39-WN	WW	2700	1600	80+	134	36-42	11.9
	CW	6500	1700	80+	142	36-42	11.9
VTCCN-H2835-200-30-WN	WW	2700	1700	80+	150	27-33	11.3
	CW	6500	1800	80+	160	27-33	11.3

Other Parameters

Model No.	LED Quantity (pcs/m)	Max Run(m/inch)	Min Cuttable Length (mm/inch)	Standard Packing Size/Reel L*W(mm/inch)
VTCCN-H2835-168-39-WN	168	5[196.85]	166.7[6.56]	5000X10[196.85X0.39]
VTCCN-H2835-200-30-WN	200	5[196.85]	100[3.94]	5000X10[196.85X0.39]

Profile Drawings

Length Unit : mm/inch

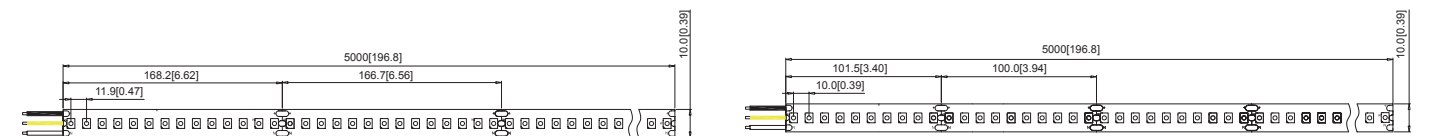

clip

Aluminum Profile

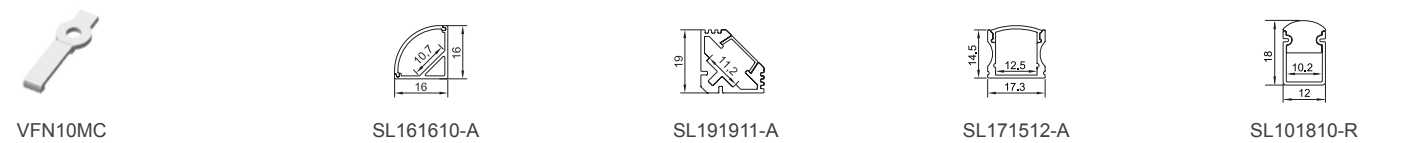

CONSTANT CURRENT DRIVE SERIES

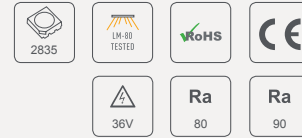

DC 36V **3** yrs warranty

Color Available

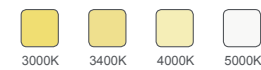

IP22(N)	IP64(WP)	IP65(W5)	IP67(WT)	IP68(WHE)	IP68(WE)	IP68(WTS/WTU)

Optical & Electrical Parameters

Model No.	Light Color	Color Temperature(K)	Luminous Flux(lm/m)	CRI/Ra	Input Voltage(V)	Power(W/m)
VCCN-G2835-78-36	W	1900-9000	1508-3626	90+	30-40	12.88-40.13
VCCN-G2835-160-36	W	1900-9000	1930-4490	80+	30-36	12.67-30.32

Other Parameters

Model No.	LED Quantity (pcs/m)	Max Run(m/inch)	Min Cuttable Length (mm/inch)	Standard Packing Size/Reel L*W(mm/inch)
VCCN-G2835-78-36	78	--	25.4[1.00]	5000X10[196.85X0.39]
VCCN-G2835-160-36	160	--	25[0.98]	5000X14[196.85X0.55]

Profile Drawings

Length Unit : mm/inch

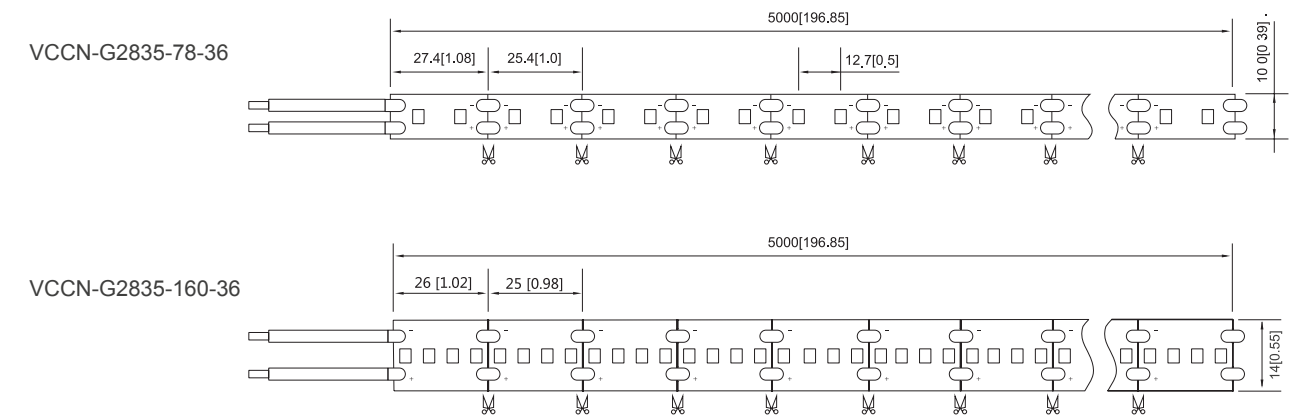

clip



NOTE: Only some common profiles are displayed,, please refer to the list of specific profiles for the rest

Joint

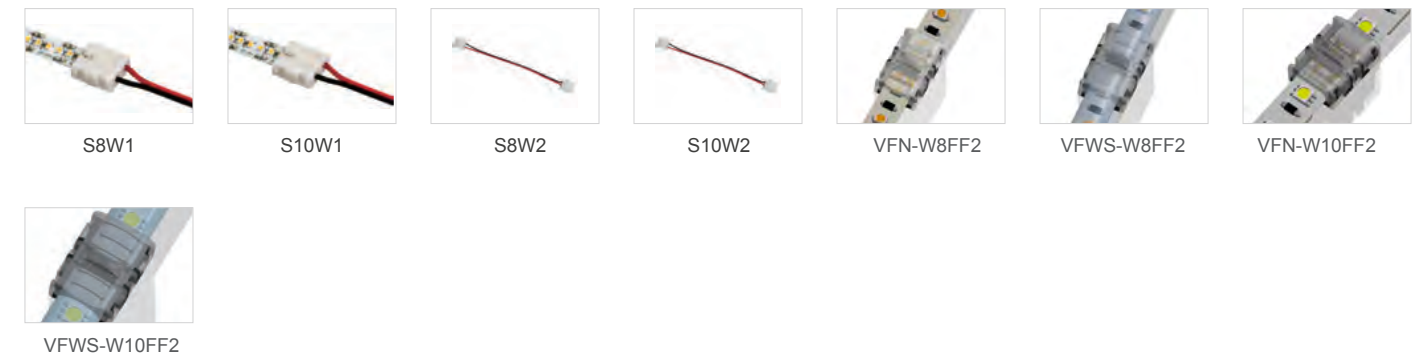

NOTE: Only some common profiles are displayed,, please refer to the list of specific profiles for the rest



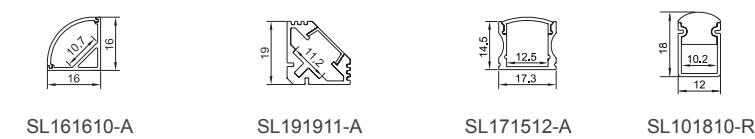

Aluminum Profile



NOTE: Only some common profiles are displayed,please refer to the list of specific profiles for the rest

ACCESSORIES

Cable Joiner

H1	H2	T1	T2
			
<p>Cable Joiner in 1PIN Working Vol.:0-36V Working Current:0-8A Cable Size:AWG18-22#(or<math>\Phi</math>2.1mm)</p>	<p>Cable Joiner in 2PIN Working Vol.:0-36V Working Current:0-8A Cable Size:AWG18-22#(or<math>\Phi</math>2.1mm)</p>	<p>T Cable Joiner in 1PIN Working Vol.:0-36V Working Current:0-8A Cable Size:AWG18-22#(or<math>\Phi</math>2.1mm)</p>	<p>T Cable Joiner in 2PIN Working Vol.:0-36V Working Current:0-8A Cable Size:AWG18-22#(or<math>\Phi</math>2.1mm)</p>

IP22 Tape Light Holder

VFN-08MC	VFN-10MC	VFN-12MC	
			
<p>IP22 Tape Light Holder Available Color:Transparent,White Applied:8mm width FPC</p>	<p>IP22 Tape Light Holder Available Color:Transparent,White Applied:8mm width FPC</p>	<p>IP22 Tape Light Holder Available Color:Transparent,White Applied:12mm width FPC</p>	

IP65(IP44) Glue Coating Tape Light Holder

VFWS-08MC	VFWS-10MC	
		
<p>IP65(IP44)Tape Light Holder Available Color:Transparent,White Applied:8mm width FPC</p>	<p>IP65(IP44)Tape Light Holder Available Color:Transparent,White Applied:10mm width FPC</p>	

QUICK CONNECTOR

Joiner-Input Cable/Tape Light

VFN-W8CF2	VFWS-W8CF2	VFN-W10CF2	VFWS-W10CF2
			
<p>IP22 Joiner for Cable to Tape Light in 2PIN Apply:8mm-Signle Color Tape Light Working Vol.:0-36V Working Current:0-3A Cable Size:AWG18-22#(or<math>\Phi</math>2.1mm)</p>	<p>IP65(IP44,glue coated) Joiner for Cable to Tape Light in 2PIN Apply:8mm-Signle Color Tape Light Working Vol.:0-36V Working Current:0-3A Cable Size:AWG18-22#(or<math>\Phi</math>2.1mm)</p>	<p>IP22 Joiner for Cable to Tape Light in 2PIN Apply:10mm-Signle Color Tape Light Working Vol.:0-36V Working Current:0-3A Cable Size:AWG18-22#(or<math>\Phi</math>2.1mm)</p>	<p>IP65(IP44,glue coated) Joiner for Cable to Tape Light in 2PIN Apply:10mm-Signle Color Tape Light Working Vol.:0-36V Working Current:0-3A Cable Size:AWG18-22#(or<math>\Phi</math>2.1mm)</p>

VFN-W10CF3	VFWS-W10CF3	VFN-W10CF4	VFWS-W10CF4
			
<p>IP22 Joiner for Cable to Tape Light in 3PIN Apply:10mm-Dual White Tape Light Working Vol.:0-36V Working Current:0-3A Cable Size:AWG18-22#(or<math>\Phi</math>2.1mm)</p>	<p>IP65(IP44,glue coated) Joiner for Cable to Tape Light in 3PIN Apply:10mm-Dual White Tape Light Working Vol.:0-36V Working Current:0-3A Cable Size:AWG18-22#(or<math>\Phi</math>2.1mm)</p>	<p>IP22 Joiner for Cable to Tape Light in 4PIN Apply:10mm-RGB Tape Light Working Vol.:0-36V Working Current:0-3A Cable Size:AWG18-22#(or<math>\Phi</math>2.1mm)</p>	<p>IP65(IP44,glue coated) Joiner for Cable to Tape Light in 4PIN Apply:10mm-RGB Tape Light Working Vol.:0-36V Working Current:0-3A Cable Size:AWG18-22#(or<math>\Phi</math>2.1mm)</p>

VFWT-W10CF2	VFWT-W10CF4
	
<p>IP64(Silicone Sleeve Encased) Joiner for Cable to Tape Light in 2PIN Apply:10mm-Single Color Tape Light Working Vol.:0-36V Working Current:0-3A Cable Size:AWG18-22#(or<math>\Phi</math>2.1mm)</p>	<p>IP64(Silicone Sleeve Encased) Joiner for Cable to Tape Light in 4PIN Apply:10mm-RGB Tape Light Working Vol.:0-36V Working Current:0-3A Cable Size:AWG18-22#(or<math>\Phi</math>2.1mm)</p>

QUICK CONNECTOR

Joiner-Input Cable/Tape Light

VFN-W8FF2



IP22 Joiner for Cable to Tape Light in 2PIN

Apply:8mm-Signle Color Tape Light
Working Vol.:0-36V
Working Current:0-3A

VFWS-W8FF2



IP65(IP44,glue coated) Joiner for Cable to Tape Light in 2PIN

Apply:8mm-Signle Color Tape Light
Working Vol.:0-36V
Working Current:0-3A

VFN-W10FF2



IP22 Joiner for Cable to Tape Light in 2PIN

Apply:10mm-Signle Color Tape Light
Working Vol.:0-36V
Working Current:0-3A

VFWS-W10FF2

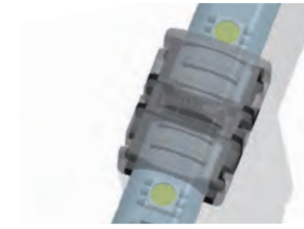

IP65(IP44,glue coated) Joiner for Cable to Tape Light in 2PIN

Apply:10mm-Signle Color Tape Light
Working Vol.:0-36V
Working Current:0-3A

VFN-W10FF3



IP22 Joiner for Cable to Tape Light in 3PIN

Apply:10mm-Dual White Tape Light
Working Vol.:0-36V
Working Current:0-3A

VFWS-W10FF3



IP65(IP44,glue coated) Joiner for Cable to Tape Light in 3PIN

Apply:10mm-Dual White Tape Light
Working Vol.:0-36V
Working Current:0-3A

VFN-W10FF4



IP22 Joiner for Cable to Tape Light in 4PIN

Apply:10mm-RGB Tape Light
Working Vol.:0-36V
Working Current:0-3A

VFWS-W10FF4



IP65(IP44,glue coated) Joiner for Cable to Tape Light in 4PIN

Apply:10mm-RGB Tape Light
Working Vol.:0-36V
Working Current:0-3A

VFWT-W10FF2

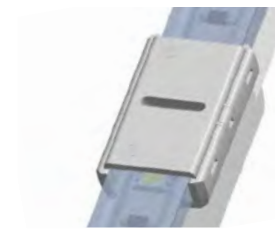

IP67(Silicone Sleeve Encased) Joiner for Cable to Tape Light in 2PIN

Apply:10mm-Single Color Tape Light
Working Vol.:0-36V
Working Current:0-3A

VFWT-W10FF4



IP67(Silicone Sleeve Encased) Joiner for Cable to Tape Light in 4PIN

Apply:10mm-RGB Tape Light
Working Vol.:0-36V
Working Current:0-3A