

NAYLOR

DRAINAGE

Made in the UK



Product Guide

email: info@naylor.co.uk web: www.naylordrainage.co.uk





Contents

Introduction to Naylor	3
Applications	4
MetroDrain and MetroDrain LC	5
Introducing MetroDrain LC	6
MetroDrain	7
MetroDrain LC	7
N-Drain	7
Gullies and accessories	10
Fabrications	10
MetroDuct introduction	11
MetroDuct	12
MetroDuct accessories	16
Metro access chambers	17
Covers and frames	18
Land drainage	19
Environmental products	20
Denlok trenchless jacking pipes	24
Deliveries	25



Developments



Telecoms



Highways



Rail



Power & Energy



Ports



Agriculture

NAYLOR

DRAINAGE

Made in the UK



Introduction to Naylor

Now exceeding 130 years in manufacturing, Naylor Plastics have an enduring reputation throughout the UK for producing high quality plastic pipe systems, together with associated products for building, construction, utility and general infrastructure markets.

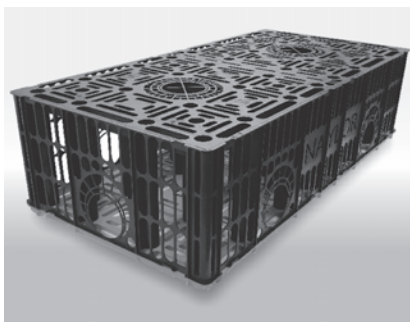

Developments



Telecoms



Highways



Rail



Power & Energy



Ports



Agriculture



INVESTORS
IN PEOPLE



Winners -
Growing Business



MADE IN
BRITAIN



MADE IN
SHEFFIELD

Telephone: 01226 790591 Email: info@naylor.co.uk www.naylordrainage.co.uk

Applications

The MetroDrain Premium Drainage system has been specified and installed on many civil engineering and construction projects.

Highway Drainage

Naylor MetroDrain is suitable for the collection and disposal of surface and sub-surface storm water. The product meets the specific requirements of the Highways Agency Manual of Contract Documents for Highway Works and is an approved alternative to the products in Table 5/1 of the Specification for Highway Works.

MetroDrain products can be adopted under the Highways Act (1980).

Building Drainage

The Naylor MetroDrain Premium Drainage System is suitable for non-adopted surface water drains.

BBA Certificate No: 09/H145 (150 to 900mm)

BBA Certificate No: ????????? (100mm)

Environmental

MetroDrain is ideally suited for use in environmental systems:

- Pump and sampling chambers
- Catchpits
- Soakaways
- Stormwater attenuation
- Manholes

Applications

- Agricultural (N-Drain)
- Highway Drainage
- CIR - Infrastructure
- Rail
- Sports Facilities/Stadiums
- Landfill
- Ports (Sea and Air)



MetroDrain

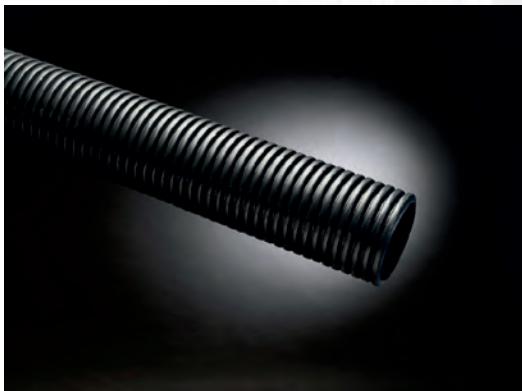

N-Drain



Developments



Highways



Rail



Ports



Agriculture

MetroDrain

Premium Drainage System

Why Naylor MetroDrain?

A range of High Density Polyethelene high performance twin wall pipes designed for use with all non-pressure, surface and sub-surface storm water drainage applications.

- Smooth bore for superior hydraulic flow
- Corrugated outer wall for additional strength
- Available in filter, perforated or half perforated configurations
- SN6
- HAPAS approved by British Board of Agrément approved
- Less brittle, less vulnerable to crack propagation
- Use of recycled materials
- Up to 6% of the weight of traditional concrete product
- Lightweight product - easier transport, handling & installation
- Recognised alternative to concrete and clayware pipes
- High strength and durability
- Excellent resistance to differential ground settlement
- Minimal jointing compared with traditional materials
- Easily cut to required lengths



MetroDrain LC

- The next generation of stormwater and surface drainage pipe
- No reduction in stiffness, jetting resistance, joint performance or durability
- Fully compatible with MetroDrain fittings
- Available in 6 sizes from 150mm to 600mm
- 3 and 6 metre lengths
- All sizes are available in full and half perforated filter drains

Nominal ID (mm)	Pipe	Pipe Stiffness (ISO9969)
100	MetroDrain LC, MetroDrain & N-Drain	SN6, SN6 & SN4
150	MetroDrain LC, MetroDrain & N-Drain	SN6, SN6 & SN4
225	MetroDrain LC, MetroDrain & N-Drain	SN6, SN6 & SN4
300	MetroDrain LC, MetroDrain & N-Drain	SN6, SN6 & SN4
375	MetroDrain LC, MetroDrain & N-Drain	SN6, SN6 & SN4
450	MetroDrain LC, MetroDrain & N-Drain	SN6, SN6 & SN4
600	MetroDrain LC, MetroDrain & N-Drain	SN6, SN6 & SN4
750	MetroDrain	SN6
900	MetroDrain	SN6
1050	MetroDrain	SN6*

*not covered by BBA



Developments



Highways



Rail



Ports



Agriculture

Telephone: 01226 790591 Email: info@naylor.co.uk www.naylordrainage.co.uk

Introducing MetroDrain LC

“All the performance, nearly half the carbon”

Standard MetroDrain

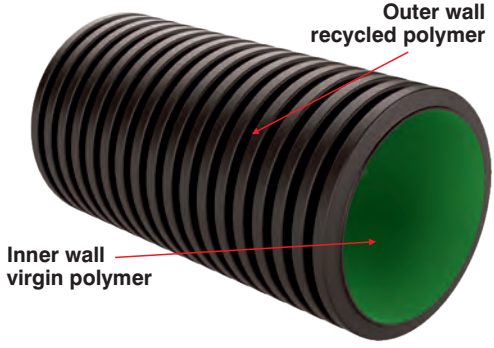

Outer wall recycled polymer

Inner wall virgin polymer

HDPE	kgCO2e/m of pipe					
	DN150	DN225	DN300	DN375	DN450	DN600
Virgin & Recycled HDPE	1.8	3.9	6.5	9.6	14	24.1

MetroDrain LC



Average 48% reduction in kgCO2e



Outer wall recycled polymer

Inner wall recycled polymer

HDPE	kgCO2e/m of pipe					
	DN150	DN225	DN300	DN375	DN450	DN600
Recycled HDPE	1.0	2.1	3.1	4.7	6.8	13.2

Sustainability

- Use of Recycled Material

Naylor is one of the UK's large user of recycled HDPE: recycled/reprocessed materials are incorporated into our products where possible and technically permissible **without compromising quality**:

- inbound materials are subject to stringent quality to ensure that the quality of finished goods is not compromised
- internal mixing and blending procedures are controlled and maintained

Source materials are primarily:

- Post industrial - produced as an industrial by-product or waste
- Reprocessed waste - any scrap product produced by our operations is granulated and the resultant material reused

Performance testing

	MetroDrain	MetroDrain LC
Material properties & specification	✓	✓
Dimensions	✓	✓
Ring stiffness	✓	✓
Creep ratio	✓	✓
Resistance to longitudinal bending	✓	✓
Impact strength	✓	✓
Rodding resistance	✓	✓
Water jetting	✓	✓
Leaktightness including subject to diameter distortion and angular deflection	✓	✓

Use of recycled Material

	MetroDrain LC	MetroDrain	N-Drain
DN 100	✓	✓	✓
DN 150	✓	✓	✓
DN 225	✓	✓	✓
DN 300	✓	✓	✓
DN 375	✓	✓	✓
DN 450	✓	✓	✓
DN 600	✓	✓	✓
DN 750		✓	
DN 900		✓	
DN 1050		✓	



Developments



Highways



Rail



Ports



Agriculture

MetroDrain



HDPE Premium Twin Wall
Carrier/Filter Drainage
System



MetroDrain Pipes



Unperforated/plain ended

ID (mm)	Nom OD (mm)	Length (m)	Pack Qty.	Nom Wt. kg/m	Code	Certification
100	117	6	85	0.9	71301	BBA
150	173	6	33	1.4	71302	BBA
225	265	6	14	3	71303	BBA
300	353	6	9	5	71304	BBA
375	432	6	5	7.4	71305	BBA
450	518	6	4	10.8	71306	BBA
600	692	6	28/Load	18.6	71307	BBA
750	860	6	18/load	26.8	71358	BBA
900	1034	6	8/load	36	71359	BBA
1050	1189	6	8/load	51.2	71360	-

Unperforated/socketed

750	918‡	3	36/load	26.8	71363	BBA
900	1093‡	3	16/load	36	71364	BBA
1050	1255‡	3	16/load	51.2	71331	-

Unperforated/socketed

750	918‡	6	18/load	26.8	71311	BBA
900	1093‡	6	8/load	36	71321	BBA
1050	1255‡	6	8/load	51.2	71328	-

‡Nominal OD including socket

Perforated/plain ended

ID (mm)	Nom OD (mm)	Length (m)	Pack Qty.	Nom Wt. kg/m	Code	Certification
100	117	6	85	0.9	71301P	BBA
150	173	6	33	1.4	71312	BBA
225	265	6	14	3	71313	BBA
300	353	6	9	5	71314	BBA
375	432	6	5	7.4	71315	BBA
450	518	6	4	10.8	71316	BBA
600	692	6	28/Load	18.6	71317	BBA
750	860	6	18/load	26.8	71361	BBA
900	1034	6	8/load	36	71137	BBA
1050	1189	6	8/load	51.2	71166	-

Perforated/socketed

750	918‡	6	18/load	26.8	71319	BBA
900	1093‡	6	8/load	36	71320	BBA
1050	1255‡	6	8/load	51.2	71329	-

‡Nominal OD including socket

Half Perforated/plain ended

ID (mm)	Nom OD (mm)	Length (m)	Pack Qty.	Nom Wt. kg/m	Code	Certification
100	117	6	85	0.9	71301HP	BBA
150	173	6	33	1.4	71322	BBA
225	265	6	14	3	71323	BBA
300	353	6	9	5	71324	BBA
375	432	6	5	7.4	71375	BBA
450	518	6	4	10.8	71376	BBA
600	692	6	28/Load	18.6	71377	BBA
750†	860	6	18/load	26.8	71126	BBA
900†	1034	6	8/load	36	71155	BBA
1050†	1189	6	8/load	51.2	71183	-

Half Perforated/socketed

750	918‡	6	18/load	26.8	71318	BBA
900	1093‡	6	8/load	36	71327	BBA
1050	1255‡	6	8/load	51.2	71330	-

‡Nominal OD including socket

*N-Drain

MetroDrain LC

HDPE Low carbon Twin Wall
Carrier Drainage System



MetroDrain LC Pipes



Unperforated/plain ended

ID (mm)	Nom OD (mm)	Length (m)	Pack Qty.	Nom Wt. kg/m	Code	Certification
150	173	6	33	1.6	74202	-
225	265	6	14	3.3	74203	-
300	353	6	9	5	74204	-
375	432	6	5	7.4	74205	-
450	518	6	4	10.8	74206	-
600	692	6	28/Load	21	74207	-

N-Drain

HDPE Agricultural Twin Wall
Carrier/Filter Drainage
System

N-Drain Pipes

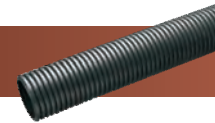

Unperforated/plain ended

ID (mm)	Nom OD (mm)	Length (m)	Pack Qty.	Nom Wt. kg/m	Code
100	117	6	85	0.63	71107
150	173	6	33	1.18	71260
225	267	6	14	2.52	71076
300	354	6	9	3.9	71075
375	433	6	5	5.59	71117
450	521	6	4	9.1	71118
600	695	6	28/Load	17.05	71093

Perforated/plain ended

ID (mm)	Nom OD (mm)	Length (m)	Pack Qty.	Nom Wt. kg/m	Code
100	117	6	85	0.63	71108
150	173	6	33	1.18	71259
225	267	6	14	2.52	71080
300	354	6	9	3.9	71079
375	433	6	5	5.59	71119
450	521	6	4	9.1	71120
600	695	6	28/Load	17.05	71121

*Half Perforated subject to minimum quantities and lead time.

For N-Drain couplings, sealing rings and fittings see MetroDrain range

MetroDrain

HDPE Premium Twin Wall
Carrier/Filter Drainage
System



MetroDrainBends

ID (mm)	Bend°	Code	Certification
100*	11¼	71401	-
100*	22½	71402	-
100*	45	71403	-
100*	90	71404	-
150	11¼	71351	BBA
150	22½	71352	BBA
150	45	71353	BBA
150	90	71354	BBA
225	11¼	71563	BBA
225	22½	71573	BBA
225	45	71583	BBA
225	90	71593	BBA
300	11¼	71504	BBA
300	22½	71514	BBA
300	45	71524	BBA
300	90	71534	BBA
375	11¼	71505	BBA
375	22½	71515	BBA
375	45	71525	BBA
375	90	71535	BBA
450	11¼	71506	BBA
450	22½	71516	BBA
450	45	71526	BBA
450	90	71536	BBA
600	11¼	71507	BBA
600	22½	71517	BBA
600	45	71527	BBA
600	90	71537	BBA
†750	11¼	71508	
†750	22½	71518	
†750	45	71528	
†750	90	71538	
†900	11¼	71509	
†900	22½	71519	
†900	45	71529	
†900	90	71539	
†1050	11¼	71510	
†1050	22½	71520	
†1050	45	71530	
†1050	90	71540	

NEW PRODUCT

† Plain ended. Requires sealing rings on all sealed systems.
100* is N-Drain only.



MetroDrain Junctions

90° Junctions/socketed

ID (mm)	Description	Code	Certification
100 x 100	T	71406	-
150 x 100	T	71604	-
150 x 150	T	71585	BBA
225 x 150	T	71587	BBA
225 x 225	T	71588	BBA
300 x 150	T	71624	BBA
300 x 225	T	71626	BBA
300 x 300	T	71628	BBA
375 x 150	T	71634	BBA
375 x 225	T	71636	BBA
375 x 300	T	71638	BBA
375 x 375	T	71640	BBA
450 x 150	T	71644	BBA
450 x 225	T	71646	BBA
450 x 300	T	71648	BBA
450 x 375	T	71650	BBA
450 x 450	T	71652	BBA
600 x 150	T	71664	BBA
600 x 225	T	71666	BBA
600 x 300	T	71668	BBA
600 x 375	T	71670	BBA
600 x 450	T	71672	BBA
600 x 600	T	71674	BBA

NEW PRODUCT

Junctions continued in next column

Requires sealing rings on all sealed systems. 100* is N-Drain only.

MetroDrain Junctions continued

90° Junctions/plain ended*

ID (mm)	Description	Code	Certification
750 x 150	T	71834	n/a
750 x 225	T	71836	n/a
750 x 300	T	71838	n/a
750 x 375	T	71840	n/a
750 x 450	T	71842	n/a
750 x 600	T	71844	n/a
750 x 750	T	71846	n/a
900 x 150	T	71854	n/a
900 x 225	T	71856	n/a
900 x 300	T	71858	n/a
900 x 375	T	71860	n/a
900 x 450	T	71862	n/a
900 x 600	T	71864	n/a
900 x 750	T	71866	n/a
900 x 900	T	71868	n/a
1050 x 150	T	71884	n/a
1050 x 225	T	71886	n/a
1050 x 300	T	71888	n/a
1050 x 375	T	71890	n/a
1050 x 450	T	71892	n/a
1050 x 600	T	71894	n/a
1050 x 750	T	71896	n/a
1050 x 900	T	71898	n/a
1050 x 1050	T	71900	n/a



Requires sealing rings on all sealed systems/couplers.

MetroDrain Junctions

45° Junctions/socketed

ID (mm)	Description	Code	Certification
100 x 100*	Y	-	-
150 x 100	Y	71698	-
150 x 150	Y	71581	BBA
225 x 150	Y	71586	BBA
225 x 225	Y	71584	BBA
300 x 150	Y	71623	BBA
300 x 225	Y	71625	BBA
300 x 300	Y	71627	BBA
375 x 150*	Y	71633	BBA
375 x 225*	Y	71635	BBA
375 x 300*	Y	71637	BBA
375 x 375*	Y	71639	BBA
450 x 150*	Y	71643	BBA
450 x 225*	Y	71645	BBA
450 x 300*	Y	71647	BBA
450 x 375*	Y	71649	BBA
450 x 450*	Y	71651	BBA
600 x 150*	Y	71663	BBA
600 x 225*	Y	71665	BBA
600 x 300*	Y	71667	BBA
600 x 375*	Y	71669	BBA
600 x 450*	Y	71671	BBA
600 x 600*	Y	71673	BBA

NEW PRODUCT

45° Junctions/plain ended

ID (mm)	Description	Code	Certification
750 x 150	Y	71833	n/a
750 x 225	Y	71835	n/a
750 x 300	Y	71837	n/a
750 x 375	Y	71839	n/a
750 x 450	Y	71841	n/a
750 x 600	Y	71843	n/a
750 x 750	Y	71845	n/a
900 x 150	Y	71853	n/a
900 x 225	Y	71855	n/a
900 x 300	Y	71857	n/a
900 x 375	Y	71859	n/a
900 x 450	Y	71861	n/a
900 x 600	Y	71863	n/a

Junctions continued in next column

Requires sealing rings on all sealed systems/couplers. 100* is N-Drain only.

MetroDrain

HDPE Premium Twin Wall
Carrier/Filter Drainage
System



MetroDrain Junctions continued



45° Junctions/plain ended

ID (mm)	Description	Code	Certification
900 x 750	Y	71865	n/a
900 x 900	Y	71867	n/a
1050 x 150	Y	71883	n/a
1050 x 225	Y	71885	n/a
1050 x 300	Y	71887	n/a
1050 x 375	Y	71889	n/a
1050 x 450	Y	71891	n/a
1050 x 600	Y	71893	n/a
1050 x 750	Y	71895	n/a
1050 x 900	Y	71897	n/a
1050 x 1050	Y	71899	n/a

Requires sealing rings on all sealed systems.

MetroDrain Level Invert Reducers



Socketed

ID (mm)	Code
150 x 100	71701
225 x 150	71703
300 x 150	71705
300 x 225	71706
375 x 150	71708
375 x 225	71709
375 x 300	71710
450 x 150	71712
450 x 225	71713
450 x 300	71714
450 x 375	71715
600 x 150	71717
600 x 225	71718
600 x 300	71719
600 x 375	71720
600 x 450	71721
750 x 150	71742
750 x 225	71743
750 x 300	71744
750 x 375	71745
750 x 450	71746
750 x 600	71747
900 x 150	71752
900 x 225	71753
900 x 300	71754
900 x 375	71755
900 x 450	71756
900 x 600	71757
900 x 750	71758
1050 x 150	71772
1050 x 225	71773
1050 x 300	71774
1050 x 375	71775
1050 x 450	71776
1050 x 600	71777
1050 x 750	71778
1050 x 900	71779

Requires sealing rings on all sealed systems.

MetroDrain Couplings



ID (mm)	Pallet Qty.	Dimension mm A	Code	Certification
100*	400	-	71085	-
150	200	176	71332	BBA
225	96	284	71333	BBA
300	45	353	71334	BBA
375	25	330	71335	BBA
450	20	396	71336	BBA
600	12	485	71337	BBA
750	2	700	71045	BBA
900	2	800	71047	Pending
1050	2	900	71050	-

One coupling and two seals are required per joint if coupling used.
100* is N-Drain Couplings only

End Caps



Size (mm)	Code
150	71802
225	71803
300	71804
375	71805
450	71806
600	71807

MetroDrain Sealing Rings



ID (mm)	Material	Pack Qty.	Code	Certification
100	EPDM	1	71001	BBA
150	EPDM	1	71342	BBA
225	EPDM	1	71343	BBA
300	EPDM	1	71344	BBA
375	EPDM	1	71345	BBA
450	EPDM	1	71346	BBA
600	EPDM	1	71347	BBA
750	EPDM	1	71099	BBA
900	EPDM	1	71102	BBA
1050	EPDM	1	71104	-

Two seals are required per joint

Lubricant



Size (Kg)	Code
1.0	50001
2.5	50002

DN Pipe Size	100	150	225	300	375	450	600	750	900	1050
Average No. of Joints per Kg.	100	50	30	24	15	10	8	5	3	2

Suitable for all types of push fit gravity pipe systems. We cannot guarantee the performance of the product if Naylor Lubricant is not used.

Gullies/Accessories



Ribbed Road Gullies

All Plastic HDPE Gullies are supplied complete with internal trap and rodding eye. Supplied into stock in pack quantities only. 100% recycled.



Pack Qty.	DN Internal (Nominal)	Internal Depth (Nominal)	DN Outlet (Nominal)	Code
20	450	900	178	67003
20	450	900	160	67004
20	450	750	160	67005
20	450	750	178	67009
20	375	750	178	67002

Yard Gully

Supplied into stock in pack quantities only. 100% recycled.



Pack Qty.	Dia. (mm)	H (mm)	DN	Code
30	300	600	110	67006

Gully Connection Pipe

Dia. (mm)	Length (m)	Pallet Qty.	Code
160	25	5	67011
178	25	5	67008

Single wall Supplied in coils.

Outlet Adaptor

OD (mm)	Code	Box Qty.
160/178*	67012	20

*Reversible

160mm Outlet Connects to	178mm Outlet Connects to	Code	Box Qty.
150mm ID	150mm ID	178mm OD	Twinwall
150mm ID	150mm ID	178mm OD	Ultra-Rib
150mm ID	150mm ID	178mm OD	Clayware
150mm ID	150mm ID	160mm OD	Quantum
-	-	160mm OD	PVC-u
-	-	160mm OD	Land Drain
-	-	160mm OD	Gully Connection Pipe
-	-	178mm OD	Gully Connection Pipe
150mm ID	150mm ID	160mm OD	Quantum
-	-	160mm OD	PVC-u
-	-	160mm OD	Land Drain
-	-	160mm OD	Gully Connection Pipe

Adaptor Coupling

OD (mm)	Code	Box Qty.
178/172	71700	-

Fabrications

A comprehensive fabrication service is available producing complementary items such as bespoke catchpits, manholes, fittings and flow control chambers etc.

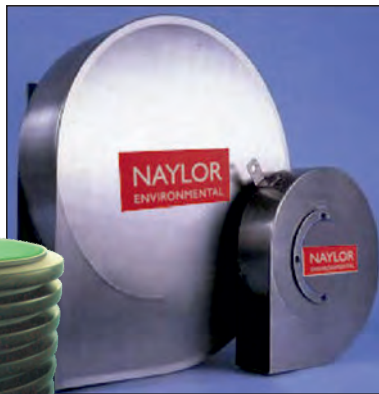

Please contact sales office for price and availability.

Naylor MetroDuct

Introduction

Naylor offer a technically advanced and comprehensive range of ducting systems. With production facilities in both England and Scotland we are well placed to meet the needs of civils, utility, telecommunication markets and others.



The Naylor ducting system comprises three main components: ducting pipes, access chambers, covers and frames.

Naylor 50-150mm ducting is manufactured to BBA and BS EN61386 as required by the Highways Agency.



Developments



Telecoms



Highways



Rail



Power & Energy



Ports

MetroDuct



NJUG Colour Coding

All MetroDuct Twin Wall Pipes up to 150mm
Manufactured to BS EN 61386

Colour	Application
Black/Red	Electricity/Power
Orange	Street Lighting/Traffic Signal
Purple	Motorway Communication/ Street Lighting (Scotland)
Yellow	Gas
Blue	Water
Green	CCTV
Grey	Telecommunications

Up to 150mm manufactured in accordance to BS EN 61386

MetroDuct - Twin Wall Split Duct

C/W Dowels or ties as appropriate.

ID/OD (mm)	Length (m)	Pack Qty.	Code
94/110	1	100	29285
100/120	1	85	29080
125/145	1	72	29210
150/178	1	33	29121
94/110	3	100	29070
100/120	3	85	29081
125/145	3	72	29242
150/178	3	33	29223

Made to order, subject to a lead time.

Class 1 Twin Wall Duct

Fully compliant with ENATS 12/24 Certificate No. A3002
HDPE Twinwall Ducting

ID/OD (mm)	Length (m)	Colour	Pack Qty.	Code	Certification
100/120	6	Black/Red	85	29526	ENATS 12/24
125/145	6	Black/Red	72	29626	ENATS 12/24
150/178	6	Black/Red	33	29726	ENATS 12/24



MetroDuct - Twin Wall - Unmarked Black

HDPE Twin Wall Ducting

ID/OD (mm)	Length (m)	Pack Qty.	Code	Certification
94/110*	6	100	29450	BBA
100/120*	6	85	29451	BBA
125/145*	6	72	29452	BBA
137/160*	6	33	29453	BBA
150/178*	6	33	29454	BBA

*Subject to minimum order quantity and lead time.

Class 2 Twin Wall Cable Duct

Fully compliant with ENATS 12/24 Certificate No. T5952

ID/OD (mm)	Length (m)	Pack Qty.	Code	Certification
100/120	6	85	29516	ENATS 12/24
100/120	3	85	29513	ENATS 12/24
100/120	2	85	29512	ENATS 12/24
100/120	1	85	29511	ENATS 12/24
125/145	6	72	29616	ENATS 12/24
125/145	3	72	29613	ENATS 12/24
125/145	2	72	29612	ENATS 12/24
125/145	1	72	29611	ENATS 12/24
150/178	6	33	29716	ENATS 12/24
150/178	3	33	29713	ENATS 12/24
150/178	2	33	29712	ENATS 12/24
150/178	1	33	25711	ENATS 12/24

Supplied with one coupling per length.

MetroDuct Sealed System

Motorway Communications/Power

ID/OD (mm)	Length (m)	Pack Qty.	Code
94/110+	6	100	29007
100/120+	6	85	29388
150/178+	6	33	29370

For sealed system 2 sealing rings required per 6m length.

* Subject to minimum order quantity and lead time.

MetroDuct Sealed System

Motorway Communications

ID/OD (mm)	Length (m)	Pack Qty.	Code	Certification
94/110	6	100	29046	BBA
100/120	6	85	29364	BBA
150/178	6	33	29420	BBA

For sealed system 2 sealing rings required per 6m length.

* Subject to minimum order quantity and lead time.

MetroDuct - Twin Wall - Electric Black

Heavy Duty HDPE Twin Wall Ducting
Printed - Electric Cable Duct

ID/OD (mm)	Length (m)	Pack Qty.	Code	Certification
94/110	6	100	29120	BBA
100/120	6	85	29278	BBA
125/145	6	72	29111	BBA
137/160	6	33	29119	BBA
150/178	6	33	29112	BBA
100/120	3	85	29208	BBA
125/145	3	72	29273	BBA
150/178	3	33	29275	BBA
100/120	2	85	29347	BBA
125/145	2	72	29199	BBA
150/178	2	33	29209	BBA

MetroDuct Twin Wall Coiled Ducting

HDPE/MDPE Twin Wall Ducting

ID/OD (mm)	Length (m)	Colour	Pallet Qty.	Code	Certification
50/63	50	Black	8	29113	BS
94/110	50	Black	5	29267	BS
137/160	25	Black	7	29268	BS
137/160	50	Black	4	29092	BS

Coils supplied with pre-installed draw string and coupling.

MetroDuct



MetroDuct Twin Wall

Motorway Communication - Purple
Printed - Motorway Communications

ID/OD (mm)	Length (m)	Pack Qty.	Code	Certification
94/110	6	100	29043	BBA
100/120	6	85	29200	BBA
137/160	6	33	29249	BBA
150/178	6	33	29059	BBA

Supplied with one coupling per length.

MetroDuct Twin Wall Coiled Ducting

Motorway Communications - Purple
Printed - Motorway Communications

ID/OD (mm)	Length (m)	Pallet Qty.	Code	Certification
50/63	50	8	29279	BS
94/110	50	5	29280	BS
137/160*	50	4	29019	BS

MetroDuct Twin Wall

Street Lighting/Traffic Signal or Plain - Orange

ID/OD (mm)	Length (m)	Marked	Pack Qty.	Code	Certification
50/63*	6	SL	158	29087	BBA
50/63*	6	TS	158	29086	BBA
94/110	6	SL	100	29085	BBA
94/110	6	TS	100	29084	BBA
94/110	6	Plain	100	29042	BBA
100/120*	6	SL	85	29083	BBA
100/120*	6	TS	85	29082	BBA
100/120*	6	Plain	85	29052	BBA
137/160*	6	SL	33	29198	BBA
137/160*	6	TS	33	29189	BBA
137/160*	6	Plain	33	29197	BBA
150/178	6	SL	33	29061	BBA
150/178	6	TS	33	29356	BBA
150/178*	6	Plain	33	29357	BBA

MetroDuct Twin Wall Coiled Ducting

Orange

ID/OD (mm)	Length (m)	Marked	Pallet Qty.	Code	Certification
50/63	50	SL	8	29091	BS
50/63	50	TS	8	29090	BS
50/63	50	Plain	8	29037	-
94/110	50	SL	5	29089	BS
94/110	50	TS	5	29088	BS
94/110	50	Plain	5	29047	-
137/160*	50	SL	4	29135	BS
137/160*	50	TS	4	29348	BS
137/160*	50	Plain	4	29124	-

*Subject to minimum order quantity and lead time.

Metro Twin Wall Utility Ducting

Yellow

ID/OD (mm)	Length (m)	Pack Qty.	Code	Certification
94/110	6	100	29045	BBA
100/120*	6	85	29349	BBA
137/160	6	33	29244	BBA
150/178	6	33	29358	BBA
225/266+	6	14	29411	-
300/353+	6	9	29412	-
450/518	6	4	29437	-

Yellow Perforated

ID/OD (mm)	Length (m)	Pack Qty.	Code	Certification
150/178	6	33	29431	-
225/266	6	14	29424	-
300/353	6	9	29427	-
450/518	6	4	29436	-

Blue

ID/OD (mm)	Length (m)	Pack Qty.	Code	Certification
94/110	6	100	29110	BBA
100/120*	6	85	29350	BBA
137/160	6	33	29241	BBA
150/178	6	33	29355	BBA
225/266+	6	14	29413	-
300/353+	6	9	29414	-
450/518	6	4	29434	-

Blue Perforated

ID/OD (mm)	Length (m)	Pack Qty.	Code	Certification
150/178	6	33	29432	-
225/266	6	14	29428	-
300/353	6	9	29433	-
450/518	6	4	29435	-

Green - CCTV Printed

ID/OD (mm)	Length (m)	Pack Qty.	Code	Certification
94/110	6	100	29281	BBA
100/120*	6	85	29351	BBA
137/160*	6	33	29250	BBA
150/178	6	33	29359	BBA

Grey - Telecommunications

ID/OD (mm)	Length (m)	Pack Qty.	Code	Certification
94/110*	6	100	29238	BBA
150/178*	6	33	29396	BBA

Red - unprinted*

ID/OD (mm)	Length (m)	Pack Qty.	Code	Certification
94/110*	6	100	29170	BBA

Supplied with one coupling per length.

* Subject to minimum order quantity and lead time.

+ Please Note: Pipe supplied plain ended - order couplings separately.

MetroDuct



MetroCoil Single Wall Ducting



Yellow Perforated Gas Duct Pipe Kitemarked to BS4962

OD (mm)	Length (m)	Pallet Qty.	Code	Certification
60	50	8	68075	BS
60	150	5	68074	BS
80	25	9	68073	BS
80	50	7	68072	BS
80	100	4	68071	BS
100	25	7	68070	BS
100	50	6	68069	BS
100	100	4	68068	BS
160	50	4	68066	BS

Sealing Rings



Black as standard

Diameter (mm)	Code
110	29107
120	29115
160	29106
178	29117

For sealed system 2 sealing rings required per 6m length.

MetroDuct Twin Wall Utility Ducting



Yellow Coils

ID/OD (mm)	Length (m)	Pallet Qty.	Code	Certification
50/63	50	8	29040	BS
94/110	50	5	29050	BS

Blue

ID/OD (mm)	Length (m)	Pallet Qty.	Code	Certification
50/63	50	8	29039	BS
94/110	50	5	29049	BS

Green

ID/OD (mm)	Length (m)	Pallet Qty.	Code	Certification
50/63	50	8	29094	BS
94/110	50	5	29171	BS

Coils supplied with pre-installed draw string and coupling.
Other colours available subject to a minimum order quantity and lead time.

Twin Wall Bends



Supplied plain ended. Black as standard.

ID/OD (mm)	11¼° Code	22½° Code	45° Code	90° Code
94/110	29144	29141	29138	29149
100/120	29215	29174	29164	29159
125/145	29243	29165	29166	29156
137/160	29022	29180	29181	29182
150/178	29262	29183	29163	29162

Order couplings separately.

Couplings

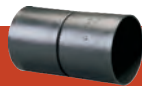

Black as standard

OD (mm)	Bag Qty.	Code
40	-	29161
50	-	29167
63	2000	29104
90	-	29103
110	400	29225
120	400	29101
145	250	29100
160	200	29099
178	200	29098

MetroDuct



MetroCoil Single Wall Ducting

Street Lighting Scotland - Purple

OD (mm)	Length (m)	Colour	Code
35	25	Purple	M68027
63	100	Purple	M68006
105	40	Purple	M68001

MetroSmooth Duct

Street Lighting/Traffic Signal

ID/OD (mm)	Description	WT (mm)	Pack Qty	Code
53/63*	Street Lighting	5	288	38028
97/107	Street Lighting	5	76	38091
53/63*	Traffic Signal	5	288	38059
97/107	Traffic Signal	5	76	38030

Supplied with a coupler. Extra couplings to be ordered separately.
*Subject to minimum order quantity and lead time.

MetroSmooth Couplings

ID/OD (mm)	Code
53/63	38007
97/107	38042

MetroSmooth Electric Cable Duct

ID/OD (mm)	WT (mm)	Length (m)	Code
32/37	2.5	25	38020
32/37	2.5	50	38023
32/37	2.5	100	38024
38/44	3	25	38021
38/44	3	50	38025
38/44	3	100	38026
50/60	5	25	38033
50/60	5	50	38034

HDPE Smooth internal and external. Colour Black.
Coils supplied plain ended and couplers can be made to special order and a minimum order quantity applies.

General Purpose Duct

Dia (in)	Nom Dia (mm)	Pack Qty	Code
2	54	369	30052
3	88.9	125	30053
4	114	76	30054
6	168	39	30055
8	200	25	30056

6 Metre lengths.
Lightweight applications only. Check suitability before installation.
NB. Requires adequate protection during installation.

General Purpose Duct Bends

Dia (in)	Dia (mm)	Bag Qty	11¼° Code	22½° Code	45° Code	90° Code
2	54	50	36054	36058	36071	36073
3	88.9	15	36053	36057	36078	36074
4	114	10	36052	36056	36079	36075
6	168	2	36051	36055	36080	36076
8	200	1	-	-	36081	36077

Supplied into stock in bag quantities only.

General Purpose Duct Connectors

Dia. (in)	Dia. (mm)	Bag Qty	Code
2	54	100	36050
3	88.9	50	36049
4	114	50	36048
6	168	25	36047
8	200	1	36046

Supplied into stock in bag quantities only.

MetroDuct Accessories



Duct Spacer

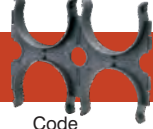

Description	Size (mm)	Code
4 Way	110	29230
4 Way	120	29375
4 Way	150 (178)	29399
6 Way	110	29228
6 Way	150 (178)	29231
8 Way	150 (178)	29235

MetroCoil Fittings



Junction Boxes - Scotland

OD (mm)	Colour	Code
105	Black	M68132

Connectors - Scotland

OD (mm)	Colour	Code
63	Black	M29343
105	Black	M29345

Reducers - Scotland

OD (mm)	Colour	Code
105x63	Black	68008

End Caps



Diameter (mm)	Code
63	29131
90*	29130
110	29129
120	29128
145	29127
160	29126
178	29168

*Subject to minimum order quantity and lead time.

Lubricant



Size (Kg)	Code
1.0	50001
2.5	50002

Suitable for all types of push fit gravity pipe systems. We cannot guarantee the performance of the product if Naylor Lubricant is not used.

Sitework Equipment



Draw Cord

Description	Code
220 Metre Coil	29264
500 Metre Drum	29191

Nominal 5kN Breaking Strength. 6mm cord.

Marker Tape



Service	Colour	Code
Electric Cable	Yellow	34036
Water Main	Blue	34037
Gas Main	Yellow	34038
Telephone Cable	Green	34039
Foul Sewer	Red	34040
Street Lighting	Yellow	34041

365m Rolls.

Metro Access Chamber

The Naylor Modular Access Chambers systems are an easy to assemble, eco-friendly system, which can either be supplied flat packed or pre-assembled depending on the customer's preference.

Metro Access Chambers



Clear Opening (W) mm	Clear Opening (L) mm	Depth (D) mm	Pallet Qty.	Code
300	300	330	18	69224
300	450	330	18	69225
450	450	330	24	69226
450	600	330	18	69227
600	600	330	13	69228

Larger sizes are available upon request.
Supplied fully assembled or flat packed.



Features

- Panels quick and easy to assemble
- Interlock design at each corner
- Panels available from 300, 450 & 600mm
- Panels are 330mm deep, with locking features
- Panels are trepanned to take pipe from 63mm to 160mm
- Wide flange design, enables covers to fit onto top chamber ring

Benefits

- Manufactured from recycled Polypropylene
- External wall patterned, such that concrete surround will flow into voids
- Composite covers & frames available
- Adaptors available to suit 178mm pipe
- Chamber system used by many Local Authorities

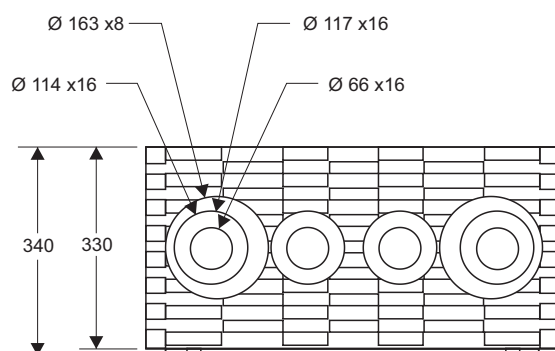

Please refer to Technical Document for Installation Details

Access Plate Packaging Details

Plate Size mm	Pallet Qty.	Code
300	600	69220
450	400	69221
600	200	69222
900	200	69229
1200	150	69230

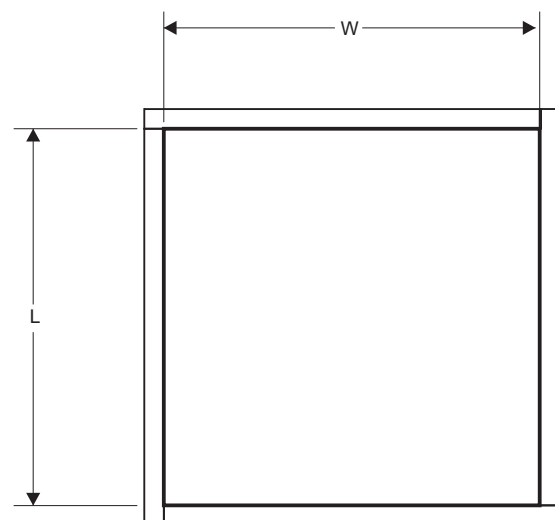

Developments



Telecoms



Highways



Rail



Power & Energy



Ports



Agriculture

Covers and Frames

Composite and Galvanised

Features and Benefits

- Composite covers available with an integral anti-skid pattern on the surface, load rated to BS EN124 Class B125
- Composite Covers are black in colour and marked 'Naylor Drainage' with the legend 'Traffic Signals' or 'Street Lighting' where applicable
- Composite Covers have integral lifting keyholes and locking features available as standard
- A wide external frame flange enables easy fit onto Naylor Access Chambers
- A deep seated galvanised frame ensures flush fit to Naylor Access Chambers
- Covers available in all sizes to fit Naylor Metro Access Chambers
- Used by many Local Authorities
- Stocked as standard



Metro Covers & Frames	
Composite - Anti Slip	
Dimension (mm)	Code
300x300	69128
300x450	69129
450x450	69127
450x600	69126
600x600	69125

Market sectors

- Building
- Construction
- Highways
- Water
- Rail
- Traffic Signal & Street Lighting
- Ministry of Defence
- Agriculture



Developments



Telecoms



Highways



Rail



Power & Energy



Ports



Agriculture

Land Drainage



Agri-Drain Land Drainage

Perforated - Black

External Dia. (mm)	Length (m)	Colour	Pallet Qty.	Code
60	25	Black	12	68029
60	50	Black	8	68032
60	150	Black	5	68033
80	25	Black	9	68034
80	50	Black	7	68035
80	100	Black	4	68036
100	25	Black	7	68037
100	50	Black	6	68038
100	100	Black	4	68039
160	50	Black	4	68007
160†	35	Black	-	68094

Manufactured in 100% recycled HDPE.
Manufactured in accordance with BS 4962.
†Scotland only.

Agri-Drain Land Drainage

Unperforated - Black

External Dia. (mm)	Length (m)	Colour	Pallet Qty.	Code
60	50	Black	8	68042
60	150	Black	5	68043
80	25	Black	9	68048
80	50	Black	7	68053
80	100	Black	4	68049
100	25	Black	7	68050
100	50	Black	6	68044
100	100	Black	4	68045
160	50	Black	4	68009
160†	35	Black	-	68046

Manufactured in 100% recycled HDPE.
Manufactured in accordance with BS 4962.
†Scotland only.

Kitemarked Land Drainage

Perforated - Black

External Dia. (mm)	Length (m)	Colour	Pallet Qty.	Code	Certification
60*	50	Black	8	68202	BS
60*	150	Black	5	68204	BS
80*	25	Black	9	68301	BS
80*	50	Black	7	68302	BS
80*	100	Black	4	68303	BS
100*	25	Black	7	68401	BS
100*	50	Black	6	68402	BS
100*	100	Black	4	68403	BS
160*	50	Black	4	68502	BS

Manufactured in 100% recycled HDPE.
Kitemarked to BS 4962

Unperforated - Black

External Dia. (mm)	Length (m)	Colour	Pallet Qty.	Code	Certification
60*	150	Black	5	68214	BS
80*	100	Black	4	68313	BS
100*	100	Black	4	68413	BS
160*	50	Black	4	68512	BS

Manufactured in HDPE. *Marked Naylor BS 4962

Land Drainage Universal Fittings

Junctions

Description	Pack Qty.	Code
60/80/100 Multi Junction	50	68064
60/160 Multi Junction	10	68061

Land Drainage Connectors

External Dia. (mm)	Code
60	68086
80	68087
100	68062
160	68063

Land Drainage End Caps

External Dia. (mm)	Code
60	68090
80	68088
100	68091
160	68109

Wrapped Land Drainage

Geotextile wrapped land drainage coil prevents ingress of very fine particles, such as sand and sediment, in appropriate soil conditions.

Land Drainage

Agri-Wrapped Land Drainage
Available in 80 and 100mm diameters in 50m lengths

External Dia. (mm)	Length (m)	Pallet Qty.	Code
80	50	5	68077
100	50	5	68118
160	50	3	68119

Naylor Environmental

Sustainable Drainage Systems (SuDS)

Hard and soft SuDS solutions for the construction and building industry



MetroPave Grass & Gravel Ground Reinforcement Grids

The Naylor MetroPave grid is Made from 100% recycled plastic and is designed to withstand loading of up to 30 tonne axle loads. The MetroPave grid is intended for use in domestic and pedestrian settings such as driveways, paths and shed bases. Units can be infilled with grass or gravel to suit the local environment and are fully SuDS compliant. Interlocking grids for a quick and easy installation process.

All quality systems and inspection procedures comply with BS EN ISO 9001: 2015 (Certificate No: FM 01420).



Product Details

Description	MetroPave
Naylor Product Code	65110
Unfilled Load Bearing Capacity (Tonnes/m ²)	150
Filled Load Bearing Capacity (Tonnes/m ²)	800
Nominal Installed Size (mm)	481x481x40
Nominal Cell Size (mm)	66x66
Grids/m ²	4.32
Infill Volume/m ²	0.034m ³
Weight (kg)	0.7 (2.98 kg/m ²)
Infiltration (mm/hr)	> 5000
Colour	Black
Material	Recycled HDPE/PP
Chemical Resistance	Excellent
UV Resistance	High
End Life	Recyclable
Connection Type	Side lugs and slots
Demarcation Block Compatibility	✓
Country Of Manufacture	UK
Pallet Details	120/pallet (27.8m ²) 1 x 1 x 1.2m (110kg)
Full Load Details	48 pallets/load (1,340m ²)

Naylor Aquavoid-Metro - Surface water attenuation and infiltration crates

Naylor's Environmental division addresses the growing need for environmental products and SuDS solutions that have a sustainable element to them, using recycled materials where possible and all offering an improvement to the surrounding built environment. These include products for both soft & hard SuDS:



MetroPave Plus Grass & Gravel Ground Reinforcement Grids

The Naylor MetroPave Plus grid is Made from 100% recycled plastic, is designed to withstand higher and more regular loading of up to 60 tonne axle loads. The MetroPave Plus grid is intended for use in commercial car parks, and car access roads. It can withstand occasional HGVs loadings for emergency access.

Units can be infilled with grass or gravel to suit the local environment and are fully SuDS compliant. Interlocking grids for a quick and easy installation process.

All quality systems and inspection procedures comply with BS EN ISO 9001: 2015 (Certificate No: FM 01420).

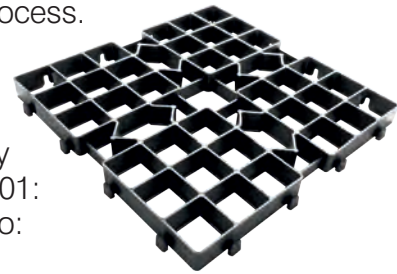

Product Details

Description	MetroPave Plus
Naylor Product Code	65111PLUS
Unfilled Load Bearing Capacity (Tonnes/m ²)	320
Filled Load Bearing Capacity (Tonnes/m ²)	1000
Nominal Installed Size (mm)	500x500x40
Nominal Cell Size (mm)	68x68
Grids/m ²	4
Infill Volume/m ²	0.035m ³
Weight (kg)	1.2 (4.8 kg/m ²)
Infiltration (mm/hr)	> 5000
Colour	Black
Material	Recycled HDPE/PP
Chemical Resistance	Excellent
UV Resistance	High
End Life	Recyclable
Connection Type	Side lugs and slots
Demarcation Block Compatibility	✓
Country Of Manufacture	UK
Pallet Details	120/pallet (30m ²) 1 x 1 x 1.2m (170kg)
Full Load Details	48 pallets/load (1440m ²)

Naylor MetroPave HGV

(75mm) Heavy Duty System

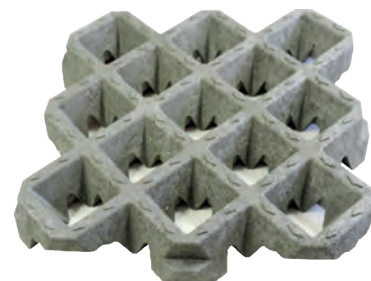



Naylor Enviroflow™ Drainage and Filtration units

The Naylor Enviroflow™ provides a unique solution for land drainage, ground stabilisation, green infrastructure and filtration solutions that are proven to be technically superior to traditional systems. Made from 100% recycled thermo-plastics, Enviroflow's products are permanent solutions that do not clog, are easy to install and handle, require little to no maintenance and are high strength and long lasting. Suitable for land drainage, water treatment, ground stabilisation, retention/detention, or permeable paving, Enviroflow™ has a solution for you.

- Enviroflow, a non-clogging fully recycled high strength land drainage and filtration solution that is easy to install and handle and requires little to no maintenance.



Naylor Smart Sponge®

The Naylor Smart Sponge® is a unique hydrocarbon (oils) removal system designed to remove the oil and permanently bond it into the molecular structure of the material so it cannot be removed under any circumstances. The subsequent waste material can be recycled via a waste to energy facility.

- The Smart Sponge® is NOT a spill kit, Smart Sponge® applications are able to remove up to 95% of all oil contaminants present in stormwater run-off. The Smart Sponge® technology remains buoyant in calm or agitated water, allowing it to remain in place until fully saturated and resulting in no wasted product.
- Smart Sponge®, an innovative way of addressing hydrocarbon pollution. Also available as Plus to treat pathogens or as HM for Heavy Metals.

Geotextiles & Membranes

Our range of Geotextiles & membranes compliment our Aquavoid & Grid solutions.

GeoGrids of various grades for ground reinforcement and stabilisation.

Grass Protection, for overlaying grassed areas to allow vehicular loads.

Naylorweb, for embankment stabilisation and tree root protection.

Environmental

Naylor Environmental for Hard and Soft SuDs Solutions

Naylor Grass & Gravel Reinforcement Grids

MetroPave

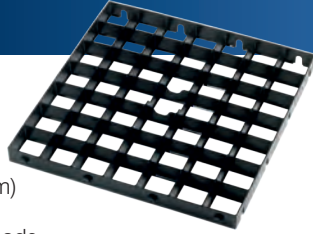

Size: 40mm (481 x 481 x 40mm)
 Use: Heavy Duty
 Strength up to 30 tonne axle loads
 Applications: Driveways, paths and shed bases, SuDs schemes & gravel areas.
 4.32 Grids/m²

Product No.	Description	Pallet
65110	Metropave 40mm deep grid	120

MetroPave HGV

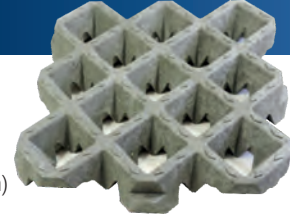

Size: 75mm (600 x 600 x 75mm)
 Use: HGV Duty
 Strength: 10,000 kN/m²
 Applications: Emergency access routes, turning areas, laybys and Truck Stops.
 2.77 Grids/m²

Product No.	Description	Pallet
65132	HGVGrid 75mm deep grid	180

MetroPave Plus



Size: 40mm (500 x 500 x 40mm)
 Use: Heavier Duty
 Strength up to 60 tonne axle loads
 Applications: Commercial car parks, and car access roads, can withstand occasional HGVs loadings for emergency access. SuDs schemes & gravel areas.
 4 Grids/m²

Product No.	Description	Pallet
65111PLUS	Metropave Plus 40mm deep grid	120

Accessories



White Demarcation Blocks
 4 No to form a "Tee", 12 per parking bay
 130 to form a disabled logo

Product No.	Description	Pallet
65120	AdPave White Markers - 40mm	100

Naylor Enviroflow™ Drainage and Filtration units

Enviroflow™



Size: 4mm (1000 x 220 x 48mm)
Use: Land & bunker drainage
Suitable for: Golf courses, sports arenas

Product No.	Description	Pallet
65300	Enviroflow Plank 4mm	152
65302	Enviroflow Filter box	1

Enviroflow™

Filter box



Naylor Aquavoid-Metro™ - Surface water attenuation and infiltration crates

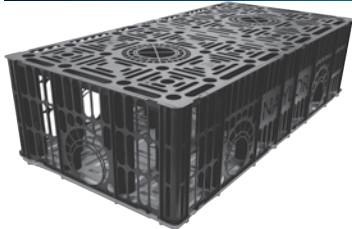

Nominal crate size	1.2m (L) x 0.6m (W) x 0.3m (H)
Nominal base size	1.2m (L) x 0.6m (W) x 0.02m (H)
Coverage Rate	4.63 crates / m ³
Volume of crates	0.216 m ³
Capacity of crates	0.2063 m ³ (void ratio 95.5%)
Weight	10.5 kg
Short Term Compressive Strength	400 kN/m ² Vertical 83 kN/m ² Lateral
Maximum Cover	2.5m
Minimum Cover	0.5m landscape, 0.6m Cars, 0.8m HGV

Product No.	Description	Qty
65230	Crates	1
65231	Bases	1
65233	Clips	100

Accessories

Geotextiles, Geomembranes, Flange Adapters and Top Hats

Product No.	Description
65510	GT1900 non-woven 180g
65514	GT1200 non-woven 100g
65520	1.0mm HDPE geomembrane
65522	0.75mm HDPE geomembrane
65527	150mm Flange Adapter
65528	225mm Flange Adapter
65529	300mm Flange Adapter

Naylor Vortex Flow Controls Surface water applications

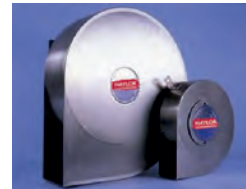

To control the flow by diverting excess water into the Naylor Aquavoid attenuation system.
Required:
Outflow in l/s and head height.

Product No.	Description	Pallet
65220	Vortex Flow Control	1

Naylor Smart Sponge®

For more specialist applications we also offer:
Smart Sponge® Plus - Pathogen removal
Smart Sponge® HM - Heavy Metal polishing

We have created a range of products to take advantage of Smart Sponge



Product No.	Description	Box
66500	Smart Gully Adapters	12
66100	Ultra Urban Filters	1
66300	Passive Skimmers	40
66200	Line Skimmers	4
66402	Smart Filters	1
66400	Smart Brakes	1
66404	Smart Stops	1
66600	Smart Paks	4

Denlok trenchless jacking pipes

Introduction

Naylor Denlok is a vitrified clay jacking pipe system to be used in conjunction with trenchless installation techniques. Such installation is undertaken wherever it is not cost effective or convenient to dig a trench to lay pipes in and will typically be used to install sewer pipelines under rivers, railways, in poor ground conditions or where pipelines are to be installed under existing infrastructure including roads and buildings. A range of installation techniques are available from specialist contractors that will involve pushing pipes underground from one vertical shaft to another.

Installation techniques include guided auger boring where augers in steel casings excavate a hole for the product pipe to be pushed in to and microtunnelling where tunnelling machines with grinding heads will dig out a hole for the product pipe to be pushed in to.

Naylor Denlok pipes come with an integrated coupling that is in-line with the external pipe diameter to allow for it to be pushed through the ground. Pipes are available in 1 or 2 metre lengths depending on the diameter allowing for pipes to be installed from a relatively small footprint and therefore minimising disruption to the surrounding area.



Naylor Denlok[®]
Ranges from 150 to 600mm diameter

1m Range

Naylor Code	Pipe Diameter (mm)	Length (m)	ID	OD	Weight KG	Max Jacking Force kN
40401	DLK 150mm	1m	149+/-3	208+/-3	45	900
40403/316	DLK 225mm	1m	225+/-4	293+/-4	80	1700
40404/316	DLK 250mm	1m	253+/-4	357+/-4	100	3400
40405/316	DLK 300mm	1m	305+/-5	412+/-5	120	4245
40409/316	DLK 400mm	1m	406+/-5	552+/-5	240	8135
40411/316	DLK 450mm	1m	450+/-5	585+/-5	250	8370
40413/316	DLK 500mm	1m	494.5+/-5	639+/-5	260	8735
40417/316	DLK 600mm	1m	609+/-7	758+/-7	340	10580

2m Range

Naylor Code	Pipe Diameter (mm)	Length (m)	ID	OD	Weight KG	Max Jacking Force kN
40404/2/316	DLK 250mm	2m	253+/-4	357+/-4	200	3400
40406/316	DLK 300mm	2m	305+/-5	412+/-5	240	4245
40410/316	DLK 400mm	2m	406+/-5	552+/-5	480	8135
40412/316	DLK 450mm	2m	450+/-5	585+/-5	500	8370
40414/316	DLK 500mm	2m	494.5+/-5	639+/-5	520	8735
40418/316	DLK 600mm	2m	609+/-7	758+/-7	680	10580

Deliveries

Delivery Times

All standard deliveries are made between the hours of 8am and 4pm unless advised at the time of order.

Timed and out of hours deliveries are available for an extra charge.

Delivery Discrepancies

Claims for transit damage or shortage cannot be accepted unless advised within 72 hours of unloading by email to queries@naylor.co.uk

Claims reported after 72 hours will not be accepted.

Vehicle Waiting Time

It is a condition of every delivery that when the vehicle reaches its destination, the customer shall unload promptly.

In the event of delays, a waiting time charge will apply as per our standard terms and conditions:-

If a vehicle is waiting in excess of 1 hour for the customer to commence unloading, the following charges will be added to the invoice:-

Part Loads: £50.00 / hour and part thereof
Full Loads: £100.00 / hour and part thereof

Please see our website for a copy of our Terms & Conditions



Developments



Telecoms



Highways



Rail



Power & Energy



Ports



Agriculture

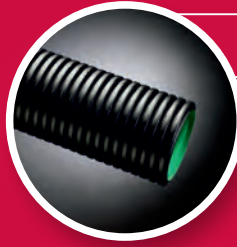

MetroDrain™

HDPE premium twin wall carrier/filter drainage system.



N-Drain™

HDPE agricultural twin wall carrier/filter drainage system.



Fabrications

Bespoke comprehensive fabrication service.



Land Drainage

Singlewall corrugated land drainage pipe.



MetroDuct™

HDPE twin wall cable ducting.



Access Chambers

Range of access chambers.



Environmental

Hard and soft SuDs solutions.

Naylor Industries plc - more than 130 years of production and supply to the Construction Industry

- Vitrified clay pipe systems for trenchless installation
- Band-Seal couplings for the repair of and connections into existing pipelines
- Plastic Land Drainage, Twinwall Ducting Systems and Access Boxes
- Yorkshire Flowerpots, a range of frostproof plant pots
- Concrete - Pre-stressed lintels and pre-cast panels, retaining walls and tanks
- Specialist Plastics - Bespoke extrusion of tubes and profiles for a variety of applications and Industries



NAYLOR DRAINAGE LIMITED

CLOUGH GREEN, CAWTHORNE
BARNSELY
SOUTH YORKSHIRE, S75 4AD
ENGLAND

OFF SEA ROAD,
METHIL, LEVEN
FIFE, KY8 3DE
SCOTLAND

TELEPHONE: 01226 790591
EMAIL: INFO@NAYLOR.CO.UK
WEB: WWW.NAYLORDRAINAGE.CO.UK

TELEPHONE: 01592 717900
EMAIL: SCOTLAND@NAYLOR.CO.UK
WEB: WWW.NAYLORDRAINAGE.CO.UK