



Engineering Protection Since 1982

In partnership with  
**XTIRPA**

# Welcome

Established in 1982, Globestock manufacture and supply a wide range of high-quality solutions for confined space access, working at height and load arrest.

We take immense pride in our many years of British manufacturing heritage and to this day we engineer products that we are proud to put our name to. An in-house Design & Development department, backed-up by our manufacturing operation in the same building, alongside our quality test and inspection area, all ensure we have control over every aspect of our own products.

For products that we supply we select only the most reputable manufacturers and the very most reliable equipment.

We are equally proud to be ISO9001 certified, and our equipment carries the CE and UKCA mark, so you can be confident in our ability to deliver for you and your client.



Information	2-9
Confined Spaces	9
<b>G</b> . Tripod	10-15
<b>G</b> . Saver	16-17
<b>G</b> . Winch	18-19
Working at Height	20
Safety Harness	21-23
Stretchers	24-25
<b>G</b> . Stop	26
<b>G</b> . AutoReel	27
Karabiners	27
Load Arrestors	28-29
<b>XTIRPA</b>	30-113
Index	114-115



[info@globestock.co.uk](mailto:info@globestock.co.uk)



+44 (0)1691 654 966



Globestock Ltd  
Mile Oak Industrial Estate  
Maesbury Road  
Oswestry  
Shropshire  
SY10 8GA  
United Kingdom



Mon – Fri: 08:00 – 17:00  
Closed weekends and bank  
holidays.

---

# Training

To complement our range of safety equipment, we offer a range of industry-leading training courses to support our customers.

- ♦ Product Awareness Sales Training
- ♦ Service Agent Training
- ♦ Inspection Training
- ♦ Train-the-trainer Inspection Training

Our outstanding courses can be tailored to suit your needs, and can be delivered on-site or at our dedicated training suite in Shropshire.

Globestock's trainers are highly qualified and experienced – with us you're learning from experts, and each course is supported by a library of carefully put together resources.

# Support

Our knowledgeable staff are available on the phone to answer any questions that you may have. Whether you need technical guidance or marketing support, just give us a call or drop us an email and we'll be happy to assist.

# Certifications



MADE IN  
BRITAIN



WAHSA  
WORK AT HEIGHT SAFETY ASSOCIATION



Company Registration Number: 01641128

VAT Registration Number: GB 372 3950 43

# Our factory and processes

Since incorporation in 1982, we've been based in the market town of Oswestry, near the Welsh border.

Our location has been a distinct advantage. As well as being centrally positioned to serve the UK, we have been able to draw talent from both the West Midlands and Mid Wales regions, resulting in an outstanding team of people.

In addition to dependable safety equipment, we offer competitive lead times, fast spares response and industry-leading technical support.



## Design

Before manufacture can take place, Globestock's dedicated Design and Development team take designs all the way from initial concept to final certification.

Concept sketches, 3D CAD modelling, digital stress analysis, and prototyping are their thing.

Apart from developing exciting new products, having a dedicated D&D team means we can quickly react to any design-change requirements as necessary, ensuring exceptional high quality on an ongoing basis.



## Welding

Exemplary welding is a real craft, developed over years of experience.

Our welders take immense pride in their work... it's all about consistency, precision and attention to detail.

This focus delivers flawless welds, which are critical when producing the most reliable safety equipment.



## Inspection

All our materials and components are painstakingly checked against specific criteria before entering stock. Anything that's not up to scratch stops here.

The Goods-In Inspection stage protects against sub-standard components being used in products, further ensuring that only the highest standard of goods make it out the door.

Some say we're obsessive...  
we're just very particular.



## Materials

The majority of our raw materials are sourced from within the UK.

As well as keeping our carbon footprint down, sourcing locally wherever possible increases our control over what goes into products, thereby optimising the quality and trustworthiness of everything we manufacture.



## Machining

CNC machines, operated by expert engineers, process the raw materials and castings, getting them ready for assembly.

Having this resource in-house gives us a huge amount of control over the manufacturing process, and allows the production team to immediately respond and assist with any design developments.

This ensures Globestock's products are always the best they possibly can be, giving end users complete confidence.



## Quality Control

Before reaching the shelves, all machined components are subject to stringent checks.

Nothing gets passed these guys!

Strict attention to detail makes sure no sub-standard parts are used, so you can be reassured that every single unit produced is without fault.



## Assembly

To make the final assembly, components are carefully put together by our highly trained bench technicians, who know the products like the back of their hands.

The expertise and professionalism of our people means consistency. It's vital that important details don't get missed.

Globestock always produce safety equipment of the highest standard, delivering peace of mind.



## Testing

All of our fall arrest devices undergo a proof load test before being sent out of the door.

This final test is not required by any necessary standard, but we go beyond compliance to deliver extra confidence in the equipment.

Our customers depend on Globestock's products to perform and protect when it matters. These are products you can trust.

# Industries



## Construction

The construction industry is, unfortunately, still a major cause of fatalities and injuries worldwide, but the majority of accidents can be avoided with the right safety training and equipment.

Globestock are specialists in construction safety equipment for confined space access and working at height. We provide products that stand up to the tough conditions that are found on construction sites around the world. Whether you are at height on a scaffold or below ground in a sewer, our products offer dependable, long-serving protection.

Globestock are proud to work with some of the biggest names in UK construction, including Balfour Beatty, Barhale and Barratt Homes. Our products can be hired from leading hire shops or purchased outright from distributors, giving you the flexibility to suit your need.



## Water & Utilities

Water, gas, electric, renewables and telecommunications industries all feature working environments that involve confined space access and work at height. Globestock are safety equipment experts, making height safety products specifically for these applications, right here in the UK. We also import the reknowned Xtirpa and KONG products.

All the products we offer are designed to meet the highest safety expectations that the industry demands, whilst delivering exceptional quality and reliability.

Whether you are working at height on a telecoms tower or in a confined space at a water treatment plant, Globestock's products offer dependable protection that is relied upon by some of the biggest names in the industry, including Severn Trent, Welsh Water and Thames Water.



## Oil, Gas & Offshore

The offshore oil and gas industries have some of the world's toughest working environments, and have high expectations when it comes to the quality and durability of safety equipment.

Offshore companies around the globe use Globestock's working at height safety products to protect people working in hazardous situations, from the rigours of the North Sea to the demanding conditions of the Middle East.

Globestock also offer SRL fall arresters with stainless steel cable, offering resistance to the corrosion caused by offshore environments.



# Confined spaces

Confined space access presents unique risks and challenges.

At Globestock we understand these risks, which is why we apply our engineering expertise to creating a range of equipment for working in confined spaces, delivering safety products you can trust.

All Globestock confined space access products are manufactured right here in the UK. Whatever the application, we offer market leading reliability in even the harshest environments.

Our other product ranges (from Xtirpa and KONG) have been carefully chosen after a thorough selection process, ensuring only the very best equipment is offered.

Depended upon by leading UK companies, including: Balfour Beatty, Barhale, Barratt Homes, Severn Trent, Welsh Water, Thames Water.

# G.Tripod 230



2 Person

EN795

TS16415

2006/42/EC



The G.Tripod 230 is an EN795 (B) + TS16415 anchorage device that is durable and lightweight. It provides a secure and stable anchorage for confined space access.

It may be used as an anchor by more than one person simultaneously, providing the MWL is not exceeded.

Available in two different sizes:  
Compact (GSE230C) / Standard (GSE230S)

- ♦ Three pulley head
- ♦ Robust and lightweight
- ♦ Simple folding design
- ♦ Two person
- ♦ Safety factor 10:1 at 200 kg

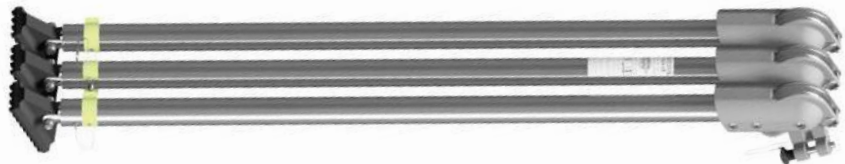
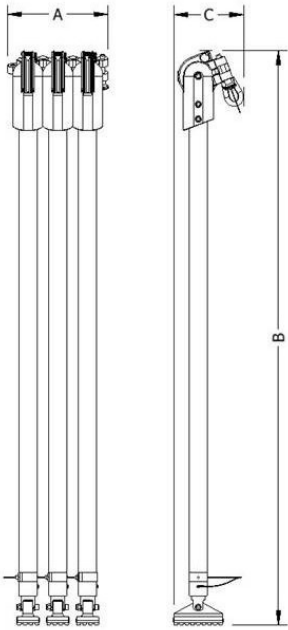

### Folded dimensions (mm):

SIZE	A	B	C
COMPACT (GSE230C)	270	1217	180
STANDARD (GSE230S)	270	1527	180

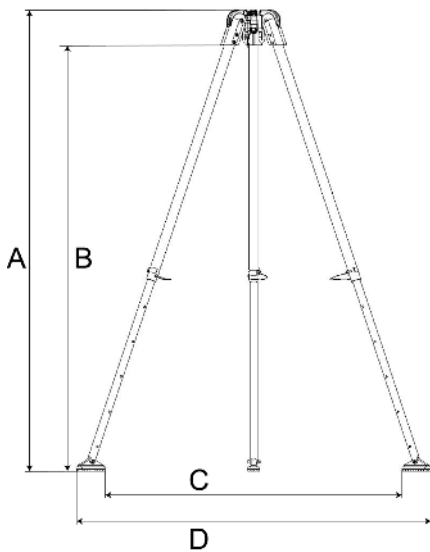

### Assembled dimensions (mm):

SIZE / CODE	A	B	C	D
COMPACT (GSE230C) *	1131	963	841	1112
COMPACT (GSE230C) **	1747	1579	1315	1585
STANDARD (GSE230S) *	1421	1253	1064	1334
STANDARD (GSE230S) **	2307	2172	1744	2015

\* at lowest setting  
 \*\* at tallest setting



Available separately:  
 G.Tripod Leg Storage Strap  
 PRODUCT CODE: TLSS

# G.Tripod Kits

## Standard Tripod Kit 1

- G.Tripod 230S
- G.Saver II 14m
- Bracket



## Standard Tripod Kit 5

- G.Tripod 230S
- G.Saver II 20m
- Bracket



## Standard Tripod Kit 6

- G.Tripod 230S
- G.Winch 250kg 20m
- G.Saver II 20m
- Brackets



## Standard Tripod Kit 7

- G.Tripod 230S
- G.Winch 250kg 20m
- G.Saver II 20m
- Rescue Harness
- Brackets



### Standard Tripod Kit 2

- ♦ G.Tripod 230S
- ♦ G.Saver II 14m
- ♦ Bracket
- ♦ Rescue Harness



### Standard Tripod Kit 3

- ♦ G.Tripod 230S
- ♦ G.Saver II 14m
- ♦ G.Winch 250kg 20m
- ♦ Brackets



### Standard Tripod Kit 4

- ♦ G.Tripod 230S
- ♦ G.Saver II 14m
- ♦ G.Winch 250kg 20m
- ♦ Rescue Harness
- ♦ Brackets



### Standard Tripod Kit 8

- ♦ G.Tripod 230S
- ♦ G.Saver II 34m
- ♦ Bracket



### Standard Tripod Kit 9

- ♦ G.Tripod 230S
- ♦ G.Winch 250kg 40m
- ♦ G.Saver II 34m
- ♦ Brackets



### Standard Tripod Kit 10

- ♦ G.Tripod 230S
- ♦ G.Winch 250kg 20m
- ♦ Brackets



### Compact Tripod Kit 1

- ♦ G.Tripod 230C
- ♦ G.Saver II 14m
- ♦ Bracket



### Compact Tripod kit 2

- ♦ G.Tripod 230C
- ♦ G.Saver II 14m
- ♦ Rescue Harness
- ♦ Bracket



### Compact Tripod Kit 3

- ♦ G.Tripod 230C
- ♦ G.Saver II 14m
- ♦ G.Winch 250kg 20m
- ♦ Brackets



### Compact Tripod Kit 4

- ♦ G.Tripod 230C
- ♦ G.Winch 250kg 20m
- ♦ G.Saver II 14m
- ♦ Rescue Harness
- ♦ Brackets



### Compact Tripod Kit 5

- ♦ G.Tripod 230C
- ♦ G.Saver II 20m
- ♦ Bracket



### Compact Tripod Kit 6

- ♦ G.Tripod 230C
- ♦ G.Saver II 34m
- ♦ Bracket



# Arrester Brackets



GSE210UMB

GSE210LMB



GSE230AB14 (for 14m)  
GSE230AB20 (for 20m)  
GSE230AB34 (for 34m)

These arrester brackets enable a G.Saver II or G.Stop fall arrester to be securely fitted to a G.Tripod.

Arrester brackets for fitting to a 50 mm square anchorage device are also available.

# G.Winch Brackets

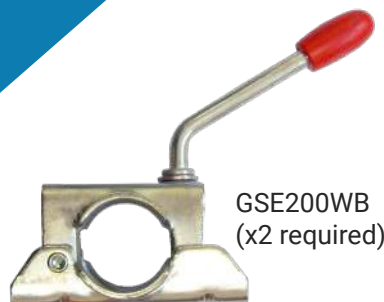

GSE200WB  
(x2 required)



50 mm Square Anchorage  
Bracket  
GSE1081-04 (x2 required)

These brackets allow the G.Winch to be securely fitted to a G.Tripod. Two brackets are required to fit one winch.

# G.Saver II



The G.Saver II is a fall arrest block that features a rescue winch for raising or lowering a fallen person to safety.

- ♦ Recovery winch with anti-run brake
- ♦ Shock absorbing brake mechanism
- ♦ Approx. 3m per minute retrieval
- ♦ Stopping distance 0.6 m to 1 m
- ♦ Fall indicator karabiner
- ♦ Top shackle included

Product Code	Max. Rope Length	Rope Kit	MWL
GSE414G	14 m	Galv rope, alu karabiner	136 kg
GSE414SSK		Stainless steel rope & 'biner	
GSE420G	20 m	Galv rope, alu karabiner	
GSE420SSK		Stainless steel rope & 'biner	
GSE434G	34 m	Galv rope, alu karabiner	
GSE434SSK		Stainless steel rope & 'biner	



MWL

EN1496

EN360







14 m

20-34 m

# G.Winch



The G.Winch is specifically certified for the lifting of both personnel and loads.

- 136 kg to 250 kg MWL options
- Anti-run brake
- Up to 50 m rope (250 kg model max. 40 m)
- Heavy duty
- Galvanised or stainless steel cable
- Can be fitted to the G.Tripod (brackets required)

2006/42/EC





Product Code	MWL	Max. Rope Length	Rope Kit
GSE070-136-20SSK	136 kg	20 m	Stainless steel rope & karabiner
GSE070-136-40SSK		40 m	
GSE070-136-50SSK		50 m	
GSE070-200-20SSK	200 kg	20 m	Stainless steel rope & karabiner
GSE070-200-40SSK		40 m	
GSE070-250-20G	250 kg	20 m	Galv. rope & aluminium karabiner
GSE070-250-40G		40 m	

#### OPTIONAL WINCH ACCESSORIES



150 kg Lifting Pulley  
GSE070USP



250 kg Lifting Pulley  
GSE070250USP

# Working at height

Working at height is a major cause of serious accidents globally.

In the UK, Globestock have been setting the benchmark for quality working at height equipment for more than 30 years. Safe working at height depends on workers not only having the right training but also, vitally, the right equipment.

When it comes to the right equipment we're experts, which is reflected in our products' design, materials, durability, and longstanding manufacturing heritage.

## Working at Height Hierarchy of Controls:

### Avoid

Do as much work as possible from the ground.

### Prevent

Stop a fall from occurring with:

- A. collective prevention, such as a guard rail.
- B. personal prevention, such as a restraint lanyard.

### Minimise

Minimise the potential fall distance and fall consequences with PPE.

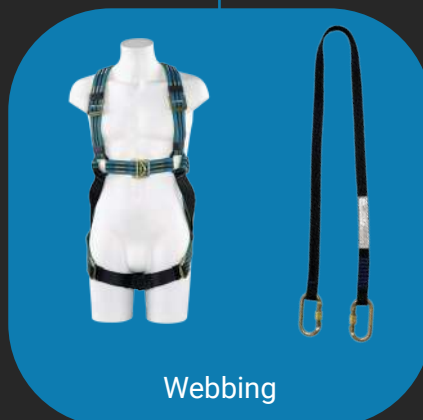

Webbing



Fall arrest

# Safety Harness



The Globestock harness range provides a secure point of attachment during confined space operations or working at height, to be used in conjunction with a fall arrester and/or winch.

Globestock has two types of harness available, the Rescue Harness and the Quick Fit Rescue Harness (see overleaf). Both come with three attachment points to ensure a secure connection in any situation. Harness shoulder yokes are also available; these provide additional support and comfort for the user while wearing the harness.

All harnesses are supplied in size large as standard, please contact us for other size options.



EN361

EN1497



	Three Bar Slide			Quick Fit Buckle		Quick Release Buckle		Attachment Points			Yoke Options	
	Shoulder Adjustment	Leg Adjustment	All Round Chest Adjustment	Shoulder Adjustment	Leg Adjustment	Chest - Fixed	Leg Adjustment	EN361 Rear D	EN361 Front D	EN1497 Overhead	Standard Shoulder Yoke	Deluxe Shoulder Yoke
<b>Rescue Harness</b>	X	X					X	X	X	X	X	
<b>Quick Fit Rescue Harness</b>			X	X	X	X		X	X	X	X	X

# Rescue Harness

Product Code	Yoke	Standard	MWL
GSE1301B	No shoulder yoke	EN361 EN1497	150 kg
GSE1303B	With shoulder yoke		

The Rescue Harness ensures the user is safe and secure during both access and rescue.

Features three attachment points, including an overhead rescue strap. The harness comes with 3 bar slide and rectangular linkage, on the leg and chest, while alloy rings are incorporated to interconnect the shoulder and chest straps. Adjustable length shoulder straps with a 3 bar buckle ensure the chest strap is positioned over the sternum comfortably and correctly.

- Overhead rescue strap
- Adjustable leg & shoulder straps
- EN361 rear D
- EN361 front D
- EN1497 overhead D
- Polyester webbing with heat treated zinc plated carbon steel fittings and anodised alloy rings



150kg  
MWL

EN361

EN1497



The Rescue Harness is also available with a shoulder yoke.

This perforated, retrofit harness yoke can be fitted to the Rescue Harness, providing additional support and comfort for the user while wearing the harness.

# Quick Fit Rescue Harness

Product Code	Yoke	Standard	MWL
GSE1302B	No shoulder yoke	EN361 EN1497	150 kg
GSE1304B	With shoulder yoke		
GSE1305B	With Deluxe shoulder yoke		

The Quick Fit Rescue Harness is designed for easy use with Quick Fit buckles to adjust the fit for the user.

The Quick Fit Rescue Harness comes fitted with 3 attachment points, along with 3 bar slide and rectangular link chest connection. Fitted with adjustable length leg loops and shoulder straps with a quick fit buckle to ensure the straps are positioned easily and correctly. The full chest strap wraps all the way around the chest, providing an exceptionally secure and comfortable configuration, which improves load distribution when using the front "D" ring.

- ♦ All round chest adjustment
- ♦ Shoulder & leg quick fit adjustment buckle
- ♦ Overhead rescue strap
- ♦ EN361 rear D
- ♦ EN361 front D
- ♦ EN1497 overhead D
- ♦ Polyester webbing with heat treated zinc plated carbon steel fittings and anodised alloy rings



The Quick Fit Rescue Harness is also available with a Standard or Deluxe Yoke.

The deluxe, padded harness yoke is available with the Quick Fit Rescue Harness. Providing superior shoulder comfort for the user with intergrated padding, while also providing additional support while in operation.



# Stretchers



The ROLLY Stretcher is designed for confined space rescue, with a flexible and light-weight design.

- Hanging kit for vertical transportation in wells or tunnels
- Hanging kit for horizontal winching
- Increased thickness providing greater resistance to rubbing, user protection and greater stability during use
- Easy maintenance with replaceable components
- Can be used in conjunction with the HALF ROLLY stretcher
- Side handles for easy transportation



The HALF ROLLY Stretcher is ideal for rescue from confined and narrow spaces.

- Rollable structure allows for flexibility during use, storage and transportation
- Hanging kit for vertical transportation
- Easy maintenance with replaceable components
- Can be used as an immobiliser during vertical use with the ROLLY stretcher
- Side handles for easy transportation



Carry Bag For ROLLY and HALF ROLLY (included)



Product	Product Code	Material	Weight (kg)	Length (cm)	Width (cm)
ROLLY	GSE1360	PE/Nylon	7.3	245	60
HALF ROLLY	GSE1361	PE/Nylon	5	135	60



# Evacuation Triangle



The Pegasus Evacuation Triangle is designed for easy and rapid evacuation.

- 15 independent attachment hoops
- Supplied with compact carry bag
- Designed for easy and rapid evacuation
- Rear handle for connection of guide rope or cabin retrieval
- Universal size

Product Code	Weight (g)	Material	Maximum Load (kg)
GSE1362	690	Nylon/ Cordura	200



Compact Carry Bag (included)



# G.Stop



EN360



The G.Stop is a durable fall arrest block with a steel cable. Engineered to remain in service for longer.

- Shock absorbing brake mechanism
- Stopping distance 0.6 m to 1 m
- Auto-lock, fall indicator karabiner
- Aluminium casing

Product Code*	Max. Rope Length	MWL	Approx. Weight	Options
GSE507G	7 m	136 kg	10 kg	Stainless steel rope.
GSE514G	14 m		11 kg	
GSE520G**	20 m		15 kg	
GSE528G**	28 m		18.5 kg	
GSE534G**	34 m		21 kg	

\* with 5 mm galvanised steel rope and fall indicator karabiner (fitted as standard). Shackle included.

\*\* casing shape differs to that pictured.

# G.Autoreel

The G.AutoReel inertia reel is an excellent lightweight, compact solution.

Weighing just 1.25 kg (complete with Equal D karabiner 1080-01), it is a fall arrester that can be used as a safe alternative to a shock absorbing lanyard. This type of product is also known as a retractable lanyard.



EN360



GSE1050 (with Equal D karabiner 1080-01)

GSE1050SC (with scaffold karabiner 1080-03)

- ♦ Lightweight & compact
- ♦ 1.25 kg (inc. 1080-01)
- ♦ Integrated shock absorber
- ♦ Fall indicator
- ♦ 2.5 m
- ♦ 140 kg max. working load

# Karabiners



070k



107k



1080-01



1080-03

EN362



Other connectors available on request.

# Load Arrestors



‘Load arrestors’ are heavy-duty fall arrest blocks for protecting equipment that is suspended at height.

They provide a secondary safety back-up for overhead loads, used in conjunction with a primary lifting device or support, such as a hoist or fixed anchorage. If the primary device fails, the load arrestor will automatically stop the load from falling, thereby preventing damage to the load and, more importantly, protecting any people below.

Globestock’s G.Guard load arrestors have a high-strength retractable rope that extracts and retracts, following the movement of the load. This means that G.Guards can be fitted to equipment that needs to be moved (dynamic loads), as well as to non-moving (static) loads. G.Guards are a cost-effective, straight-forward way of managing risk.

- Shock absorbing brake cushions the fall
- High grade galvanised steel rope is fitted as standard on all models. Stainless steel rope is available as an option (fitting stainless steel rope may affect the MWL, contact us for details).

2006/42/EC





GSE300-10G



GSE300-15G  
GSE300-20G  
GSE300-25G  
GSE500-10G  
GSE500-15G  
GSE500-20G  
GSE500-24G



GSE1000-10G



300kg

MWL Load Arrestors



500kg

MWL Load Arrestors



1000kg

MWL Load Arrestors

Product Code	Rope Length
GSE300-10G	10 m
GSE300-15G	15 m
GSE300-20G	20 m
GSE300-25G	25 m

Product Code	Rope Length
GSE500-10G	10 m
GSE500-15G	15 m
GSE500-20G	20 m
GSE500-24G	24 m

Product Code	Rope Length
GSE1000-10G	10 m

Shackles included. Galvanised steel is fitted as standard. Stainless steel is also available. Also available in black.



# XTIRPA™



610 Davit	32 - 45
1200 Davit	46 - 53
2450 Davit	54 - 57
Trench Davit System	58 - 63
Guard Rail Davit System	64 - 67
H-Base Davit System	68 - 71
Pole Hoist Davit System	72 - 76
Swivel Wall Plate	77
Hitch Mount System	78 - 83
Counterweight Davit System	84 - 91
Manhole Collar System	92 - 98
Fall Arrest Post	100 - 101
Anchor Device for Drilling	102 - 103
XLT Davit System	104 - 107
Manhole Cover Lifter	108 - 109
Ladder Adapter	110
Davit Accessories	111
Brackets	112 -113

# 610 / 76mm Short Reach Davit Arms



## IN-2210

610mm davit arm with secondary block adapter for fall protection and retrieval, Used in conjunction with mast IN-2003 and appropriate base/system or manhole guard. Quick and easy three pin assembly.



EN795

TS16415

Z359.1

Z259.2.1-98

1910.66 App C

### Product Specification

Dimensions (mm)	L 1436-1896 x W 148 x H 286
Weight (kg)	16
Main Material	Aluminium







## IN-2363

For use with manhole collar bases (p. 92-96) or trench mount bases (p.59-60). Cannot be used with fixed bases. Low clearance integrated mast and davit arm.

Product Specification	
Dimensions (mm)	L 348 x W 76 x H 920
Weight (kg)	7
Main Material	Aluminium



## IN-2395

For use with fixed bases only (p. 35-37). Possibility to use extensions to increase height of the mast.

*Available with anodised finish (IN-2395P)*

Product Specification	
Dimensions (mm)	L 469 x W 76 x H 920
Weight (kg)	10
Main Material	Aluminium



## IN-2483

For use with trench mount bases only (p. 59-60). Equipped with a 22kN anchor point. Offers the possibility of installing a winch or retractable lifeline.

Product Specification	
Dimensions (mm)	L 730 x W 124 x H 1606
Weight (kg)	23
Main Material	Aluminium



# 610 Davit Masts



## IN-2044

Product Specification	
Height (mm)	381
Weight (kg)	9.1
Main Material	Steel



## IN-2109

Product Specification	
Height (mm)	457
Weight (kg)	10.9
Main Material	Steel



## IN-2045

Product Specification	
Height (mm)	610
Weight (kg)	11.8
Main Material	Steel



## IN-2003



Product Specification	
Height (mm)	1145
Weight (kg)	10
Main Material	Aluminium

EN795

TS16415

Z359.1

Z259.2.1-98

1910.66 App C



OSHA



# 610 Davit Bases Zinc Coated



**IN-2106**

76mm  
Floor  
Base

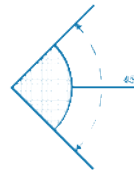

**IN-2107**

76mm  
Wall Base

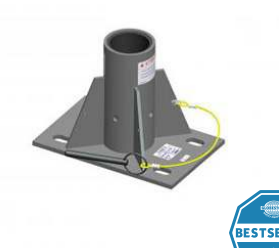
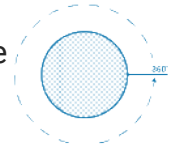

**IN-2137**

76mm  
Centre  
Floor  
Base

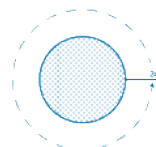

**IN-2114**

76mm  
Flush  
Floor  
Base

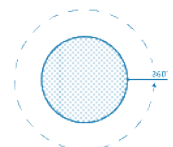

EN795

TS16415

Z359.1

Z259.2.1-98

1910.66 App C



OSHA



# 610 Davit Bases 304 Stainless Steel



**IN-2005**

76mm  
Floor  
Base

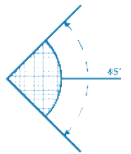

**IN-2105**

76mm  
Centre  
Floor  
Base

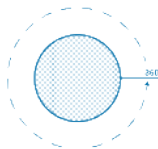

**IN-2007**

76mm  
Fresh  
Concrete  
Base

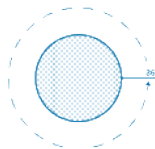

**IN-2006**

76mm  
Flush  
Floor  
Base

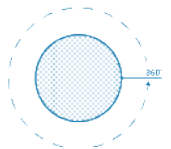

**IN-2013**

76mm  
Wall  
Base

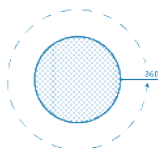

**IN-2067**

76mm  
Wall  
Base  
(365mm  
clearance)

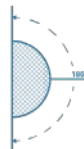

**IN-2124**

76mm  
Wall  
Base  
(203mm  
clearance)

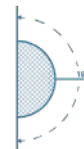

**IN-2097**

76mm  
Sleeve  
Base

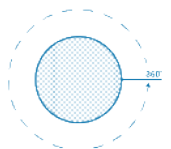

# 610 Davit Bases 316 Marine Grade

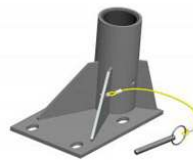

**IN-2311**

76mm  
Floor  
Base

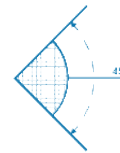

**IN-2327**

76mm  
Wall Base

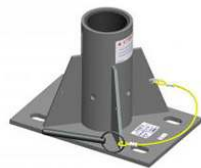
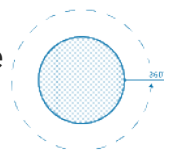

**IN-2329**

76mm  
Centre  
Floor  
Base

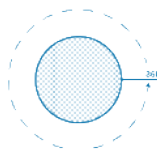

**IN-2325**

76mm  
Flush  
Floor  
Base

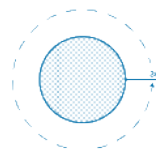

**IN-2326**

76mm  
Fresh  
Concrete  
Base

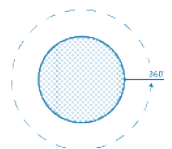

# 610 Davit Bases Mobile / Shoring Bases



**IN-2315**

51-127mm  
Barrel  
Base  
(Zinc)

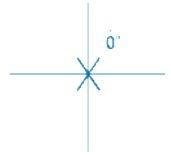

**IN-2021**

0-76mm  
Barrel  
Base  
(304 SS)



**IN-2129**

0-76mm  
Barrel  
Base  
(Zinc)



**IN-2482**

51-267mm  
Shoring  
Box

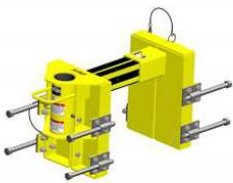
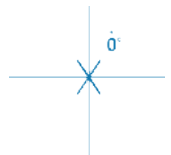

**IN-2008**

105-400mm  
Adjustable  
Wall Base

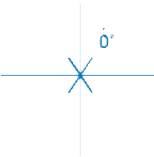

**IN-2168**

152-1143mm  
Adjustable  
Wall Base



**IN-2075**

305-800mm  
Adjustable  
Wall Base

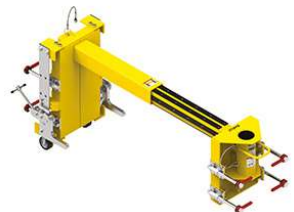
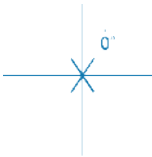

**IN-2125**

610-1143mm  
Shoring  
Adjustable  
Wall Base

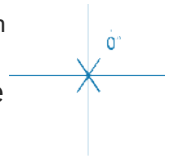

EN795

TS16415

Z359.1

Z259.2.1-98

1910.66 App C



OSHA



# Wall Mount Davit 610 Kits



## 610 Wall Mount Kits

	Kit 1	Kit 2
610mm Davit Arm	X	X
1145mm Davit Mast	X	X
Wall Mount Base	X	X
G.Saver II 14m	X	X
G.Winch 20m		X
Fall Arrest Bracket	X	X
Winch Bracket		X

# Standard Davit 610 Kits

Standard Davit 610 Kit 1



Standard Davit 610 Kit 2



Standard Davit 610 Kit 3



Standard Davit 610 Kit 4



Standard Davit 610 Kit 5





## 610 Standard Kits

	Kit 1	Kit 2	Kit 3	Kit 4	Kit 5
IN-2210 610mm Davit Arm	X	X	X	X	X
IN-2003 1145mm Davit Mast	X	X	X	X	X
<b>G.Saver II</b> 14m	X	X			
<b>G.Saver II</b> 20m			X	X	
<b>G.Saver II</b> 34m					X
<b>G.Winch</b> 20m		X		X	
<b>G.Winch</b> 40m					X
Fall Arrest Bracket	X	X	X	X	X
Winch Bracket		X		X	X
Offset Winch Adapter					

# Trench Davit 610 Hire Kits

## 610 Trench Hire Kits

	Kit 1	Kit 2
76mm Shoring Base	X	X
IN-2483 Mast & Davit Arm	X	
IN-2210 610mm Davit Arm		X
76mm Mast		X

Trench Davit 610 Hire Kit 1



Trench Davit 610 Hire Kit 2



# Trench Davit 610 Kits

Trench Davit 610 Kit 1



Trench Davit 610 Kit 2



Trench Davit 610 Kit 3



Trench Davit 610 Kit 4



Trench Davit 610 Kit 5



Trench Davit 610 Kit 6



Trench Davit 610 Kit 7



Trench Davit 610 Kit 8



Trench Davit 610 Kit 9



Trench Davit 610 Kit 10



Trench Davit 610 Kit 11



Trench Davit 610 Kit 12



Trench Davit 610 Kit 13



Trench Davit 610 Kit 14



Trench Davit 610 Kit 15



Trench Davit 610 Kit 16



## 610 Trench Davit Kits

	Kit 1	Kit 2	Kit 3	Kit 4	Kit 5	Kit 6	Kit 7	Kit 8	Kit 9	Kit 10	Kit 11	Kit 12	Kit 13	Kit 14	Kit 15	Kit 16
IN-2483 Mast-Davit Arm	X	X	X	X	X	X	X	X	X	X						
IN-2210 610mm Davit Arm											X	X	X	X	X	X
IN-2003 Davit Mast											X	X	X	X	X	X
Barrel Base (51-127mm)	X	X	X	X	X						X	X	X			
Shoring Base (51-267mm)						X	X	X	X	X				X	X	X
G.Saver II 14m	X	X				X	X				X			X		
G.Saver II 20m			X	X				X	X			X			X	
G.Saver II 34m					X					X			X			X
G.Winch 20m		X		X			X		X		X	X	X	X	X	
G.Winch 40m					X					X						X
Fall Arrest Bracket	X	X	X	X	X	X	X	X	X	X	X	X	X	X	X	X
Winch Bracket		X		X	X		X		X	X	X	X	X	X	X	X
Offset Winch Adapter		X		X	X		X		X	X						

# Floor Mount Davit 610 Kits

Floor Mount Davit 610 Kit 1



Floor Mount Davit 610 Kit 2



Floor Mount Davit 610 Kit 3



Floor Mount Davit 610 Kit 4



Floor Mount Davit 610 Kit 5



# 610 Floor Mount Kits

	Kit 1	Kit 2	Kit 3	Kit 4	Kit 5
IN-2210 610mm Davit Arm	X	X	X	X	X
IN-2003 Davit Mast	X	X	X	X	X
Centre Floor Mount Base	X	X	X	X	X
G.Saver II 14m	X	X			
G.Saver II 20m			X	X	
G.Saver II 34m					X
G.Winch 20m		X		X	
G.Winch 40m					X
Fall Arrest Bracket	X	X	X	X	X
Winch Bracket		X		X	X
Offset Winch Adapter					



# 1200 Davit Arms

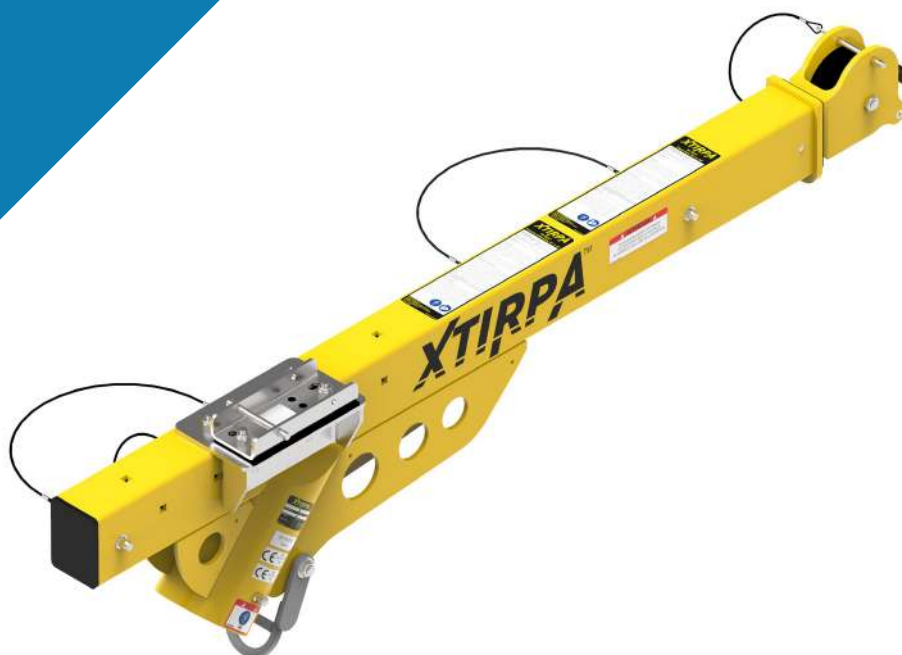

EN795

TS16415

Z359.1

Z259.2.1-98

1910.66 App C

## IN-2237

Extendable davit arm (762-1219mm) for fall protection and retrieval. Used in conjunction with mast IN-2240 or IN-2313. Equipped with 2268kg anchor point.

Product Specification	
Dimensions (mm)	L 1422-1965 x W 165 x H 977-1326
Weight (kg)	23
Main Material	Aluminium



# 1200 Davit Masts



## IN-2426

Product Specification	
Height (mm)	508
Weight (kg)	5
Main Material	Aluminium



## IN-2240



Product Specification	
Height (mm)	1067
Weight (kg)	11
Main Material	Aluminium



## IN-2313

Product Specification	
Height (mm)	1524
Weight (kg)	16
Main Material	Aluminium

EN795

TS16415

Z359.1

Z259.2.1-98

1910.66 App C



OSHA



# 1200 Davit Bases 316 Marine Grade



## IN-2452

102mm  
Floor  
Base

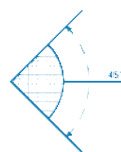

## IN-2451

102mm  
Centre  
Floor  
Base

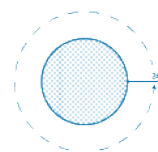

## IN-2468

102mm  
Wall  
Base

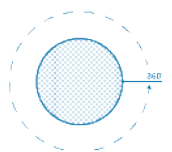

# 1200 Davit Bases 304 Stainless Steel



**IN-2238**

102mm  
Floor  
Base

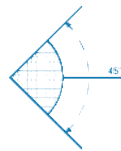

**IN-2253**

102mm  
Wall  
Base

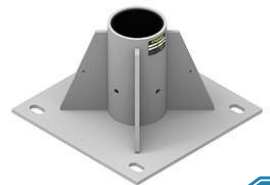
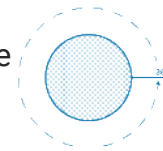

**IN-2254**

102mm  
Centre  
Floor  
Base

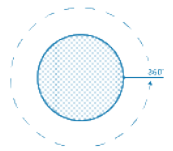

**IN-2266**

102mm  
Flush  
Floor  
Base

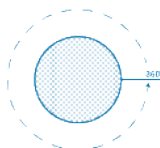

**IN-2383**

102mm  
Fresh  
Concrete  
Base

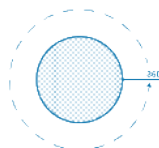

**IN-2255**

102mm  
Sleeve  
Base

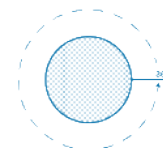

**IN-2516**

102mm  
Top Wall  
Base  
(90°)

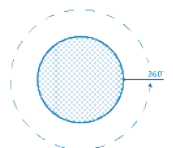

EN795

TS16415

Z359.1

Z259.2.1-98

1910.66 App C



OSHA





# 1200 Davit Bases Fixed Zinc / Galv



**IN-2302**

Zinc plated  
102mm  
Floor Base

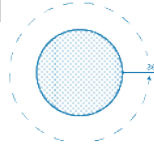

**IN-2303**

Zinc plated  
102mm  
Wall Base

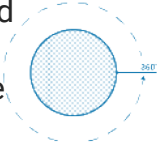

**IN-2304**

Zinc plated  
102mm  
Centre Floor  
Base

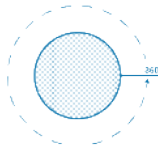

**IN-2527**

Galv.  
102mm  
Floor  
Base

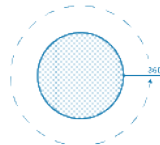

**IN-2528**

Galv.  
102mm  
Wall  
Base

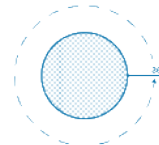

**IN-2529**

Galv.  
102mm  
Centre  
Floor  
Base

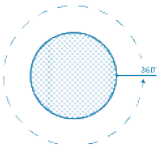

# 1200 Davit Bases Mobile / Shoring Base

**IN-2380**

254-432mm  
Adjustable  
Wall Clamp

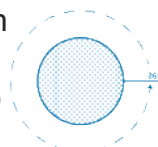

# Trench Davit 1200 Kits

Trench Davit 1200 Kit 1



Trench Davit 1200 Kit 2



Trench Davit 1200 Kit 3



Trench Davit 1200 Kit 4



Trench Davit 1200 Kit 5



## 1200 Trench Davit Kits

	Kit 1	Kit 2	Kit 3	Kit 4	Kit 5
1200mm Extendable Davit Arm	X	X	X	X	X
1067mm Davit Mast	X	X	X	X	X
Adjustable Clamp (254-433mm)	X	X	X	X	X
G.Saver II 14m	X	X			
G.Saver II 20m			X	X	
G.Saver II 34m					X
G.Winch 20m		X		X	
G.Winch 40m					X
Fall Arrest Bracket	X	X	X	X	X
Winch Bracket		X		X	X
Winch Adapter		X		X	X

# Standard Davit 1200 Kits

Standard Davit 1200 Kit 1



Standard Davit 1200 Kit 2



Standard Davit 1200 Kit 3



Standard Davit 1200 Kit 4



Standard Davit 1200 Kit 5



## 1200 Standard Kits

	Kit 1	Kit 2	Kit 3	Kit 4	Kit 5
1200mm Extendable Davit Arm	X	X	X	X	X
1067mm Davit Mast	X	X	X	X	X
G.Saver II 14m	X	X			
G.Saver II 20m			X	X	
G.Saver II 34m					X
G.Winch 20m		X		X	
G.Winch 40m					X
Fall Arrest Bracket	X	X	X	X	X
Winch Bracket		X		X	X
Winch Adapter		X		X	X

# Floor Mount Davit 1200 Kits

Floor Mount Davit 1200 Kit 1



Floor Mount Davit 1200 Kit 2



Floor Mount Davit 1200 Kit 3



Floor Mount Davit 1200 Kit 4



Floor Mount Davit 1200 Kit 5



## 1200 Floor Mount Kits

	Kit 1	Kit 2	Kit 3	Kit 4	Kit 5
1200mm Extendable Davit Arm	X	X	X	X	X
1067mm Davit Mast	X	X	X	X	X
Centre Floor Mount	X	X	X	X	X
G.Saver II 14m	X	X			
G.Saver II 20m			X	X	
G.Saver II 34m					X
G.Winch 20m		X		X	
G.Winch 40m					X
Fall Arrest Bracket	X	X	X	X	X
Winch Bracket		X		X	X
Winch Adapter		X		X	X

# 1200 Flush Floor & Wall Mount Kits

Flush Floor Davit 1200 Kit 1



Flush Floor Davit 1200 Kit 2



Wall Mount Davit 1200 Kit 1



Wall Mount Davit 1200 Kit 2



## 1200 Flush Floor & Wall Mount Kits

	Flush Floor		Wall Mount	
	Kit 1	Kit 2	Kit 1	Kit 2
1200mm Extendable Davit Arm	X	X	X	X
1067mm Davit Mast	X	X	X	X
Flush Floor Base	X	X		
Wall Mount Base			X	X
G.Saver II 14m	X	X	X	X
G.Winch 20m		X		X
Fall Arrest Bracket	X	X	X	X
Winch Bracket		X		X
Winch Adapter		X		X

# 2450 Davit Arms

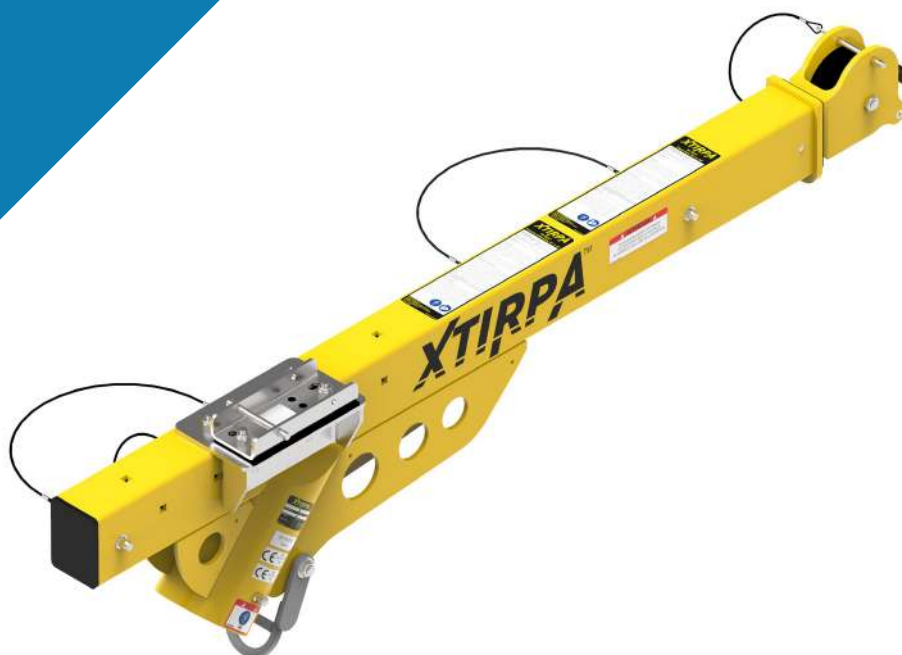

## IN-2197

Long reach davit arm extendable between 1524-2438 mm for fall protection & retrieval. The system has three separate anchor points, each with a rating of 164kg MWL.



Product Specification	
Dimensions (mm)	L 2493-3498 x W 260 x H 642
Weight (kg)	62
Main Material	Aluminium



# 2450 Masts



## IN-2470

Product Specification	
Height (mm)	610
Weight (kg)	9
Main Material	Aluminium



## IN-2199



Product Specification	
Height (mm)	1067
Weight (kg)	15
Main Material	Aluminium



## IN-2414

Product Specification	
Height (mm)	1372
Weight (kg)	20
Main Material	Aluminium

# 2450 Bases

## IN-2200

Sleeve Base  
(304 SS)



## IN-2201

104mm  
Centre  
Floor  
Base  
(304 SS)

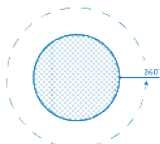

## IN-2420

104mm  
Wall  
Mount  
Base  
(304 SS)

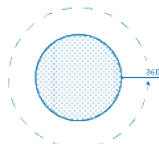

## IN-2544

104mm  
Centre  
Floor  
Base  
(316 SS)

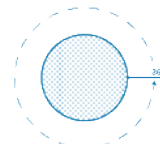

## IN-2546

104mm  
Centre  
Floor  
Base  
(304 SS)

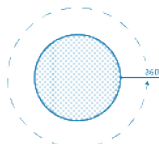

# 2450 Davit Kits

Standard Davit 2450 Kit 1



Standard Davit 2450 Kit 2



Standard Davit 2450 Kit 3



Floor Mount Davit 2450 Kit 1



Floor Mount Davit 2450 Kit 2



Floor Mount Davit 2450 Kit 3



Wall Mount Davit 2450 Kit 1



Wall Mount Davit 2450 Kit 2



Wall Mount Davit 2450 Kit 3





2450 Davit Kits	Standard			Floor Mount			Wall Mount		
	Kit 1	Kit 2	Kit 3	Kit 1	Kit 2	Kit 3	Kit 1	Kit 2	Kit 3
1524-2450mm Extendable Davit Arm	X	X	X	X	X	X	X	X	X
IN-2199 Davit Mast	X	X	X	X	X	X	X	X	X
Centre Floor Mount				X	X	X			
Wall Mount Base							X	X	X
G.Saver II 14m	X			X			X		
G.Saver II 20m		X			X			X	
G.Saver II 34m			X			X			X
G.Winch 20m	X	X		X	X		X	X	
G.Winch 40m			X			X			X
Fall Arrest Bracket	X	X	X	X	X	X	X	X	X
Winch Bracket	X	X	X	X	X	X	X	X	X



# Trench Davit System



164kg  
MWL

EN795

TS16415

Z359.1

Z259.2.1-98

1910.66 App C

For work areas that require regular setup and removal, but where a permanently fixed base and conventional access is not viable.

Adjustable base systems are an ideal solution, consisting of an adjustable base, mast and davit arm.

These versatile, lightweight, reliable and easy-to-install systems facilitate access to vertical confined spaces where various cement or steel walls are available to use as an anchor point.

The universal mast and davit arm allow for fall protection and retrieval and can be used and installed in many different adjustable bases.



# Trench Davit System

## Bases



### IN-2315

51-127mm  
Barrel  
Base  
(zinc  
plated)

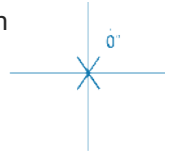

### IN-2021

0-76mm  
Barrel  
Base  
(304 SS)



### IN-2129

0-76mm  
Barrel  
Base  
(zinc  
plated)



### IN-2482

51-267mm  
Shoring  
Box

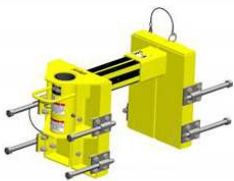
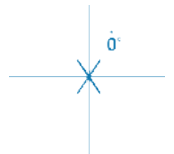

### IN-2008

105-400mm  
Adjustable  
Wall Base

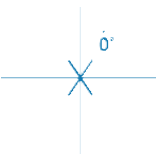

### IN-2251

305-762mm  
Adjustable  
Wall Base



### IN-2075

305-800mm  
Adjustable  
Wall Base



### IN-2125

610-1143mm  
Shoring  
Adjustable  
Wall Base



EN795

TS16415

Z359.1

Z259.2.1-98

1910.66 App C



OSHA



# Trench Davit System

IN-2380

254-432mm  
Adjustable  
Wall Camp

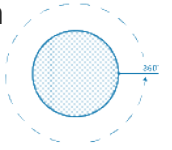

# Trench Davit System

610 Kits

Trench Davit 610 Kit 1



Trench Davit 610 Kit 2



Trench Davit 610 Kit 3



Trench Davit 610 Kit 4



Trench Davit 610 Kit 5



Trench Davit 610 Kit 6



Trench Davit 610 Kit 7



Trench Davit 610 Kit 8



Trench Davit 610 Kit 9



Trench Davit 610 Kit 10



Trench Davit 610 Kit 11



Trench Davit 610 Kit 12



Trench Davit 610 Kit 13



Trench Davit 610 Kit 14



Trench Davit 610 Kit 15



Trench Davit 610 Kit 16



**610 Trench Davit Kits**

	Kit 1	Kit 2	Kit 3	Kit 4	Kit 5	Kit 6	Kit 7	Kit 8	Kit 9	Kit 10	Kit 11	Kit 12	Kit 13	Kit 14	Kit 15	Kit 16
IN-2483 Mast-Davit Arm	X	X	X	X	X	X	X	X	X	X						
IN-2210 610mm Davit Arm											X	X	X	X	X	X
IN-2003 Davit Mast											X	X	X	X	X	X
Barrel Base (51-127mm)	X	X	X	X	X						X	X	X			
Shoring Base (51-267mm)						X	X	X	X	X				X	X	X
G.Saver II 14m	X	X				X	X				X			X		
G.Saver II 20m			X	X				X	X			X			X	
G.Saver II 34m					X					X			X			X
G.Winch 20m		X		X			X		X		X	X	X	X	X	
G.Winch 40m					X					X						X
Fall Arrest Bracket	X	X	X	X	X	X	X	X	X	X	X	X	X	X	X	X
Winch Bracket		X		X	X		X		X	X	X	X	X	X	X	X
Offset Winch Adapter		X		X	X		X		X	X						

# Trench Davit System

1200 Kits

Trench Davit 1200 Kit 1



Trench Davit 1200 Kit 2



Trench Davit 1200 Kit 3



Trench Davit 1200 Kit 4



Trench Davit 1200 Kit 5



## 1200 Trench Davit Kits

	Kit 1	Kit 2	Kit 3	Kit 4	Kit 5
1200mm Extendable Davit Arm	X	X	X	X	X
1067mm Davit Mast	X	X	X	X	X
Adjustable Base (254-433mm)	X	X	X	X	X
G.Saver II 14m	X	X			
G.Saver II 20m			X	X	
G.Saver II 34m					X
G.Winch 20m		X		X	
G.Winch 40m					X
Fall Arrest Bracket	X	X	X	X	X
Winch Bracket		X		X	X
Winch Adapter		X		X	X

# Guard Rail Davit System

Guard rail systems are used when an exposed entry point needs to be guarded.

This highly portable system has an integrated mast which is used in conjunction with a davit arm to provide fall protection, entry and retrieval capabilities.

The guard rail system facilitates access to underground chambers or any other type of confined space where an entry point should be protected.

When not in use, the guard rail folds down flat for simple storage.

May be used in the open V position pictured below (rear stabiliser A2108-18 or -20 required).

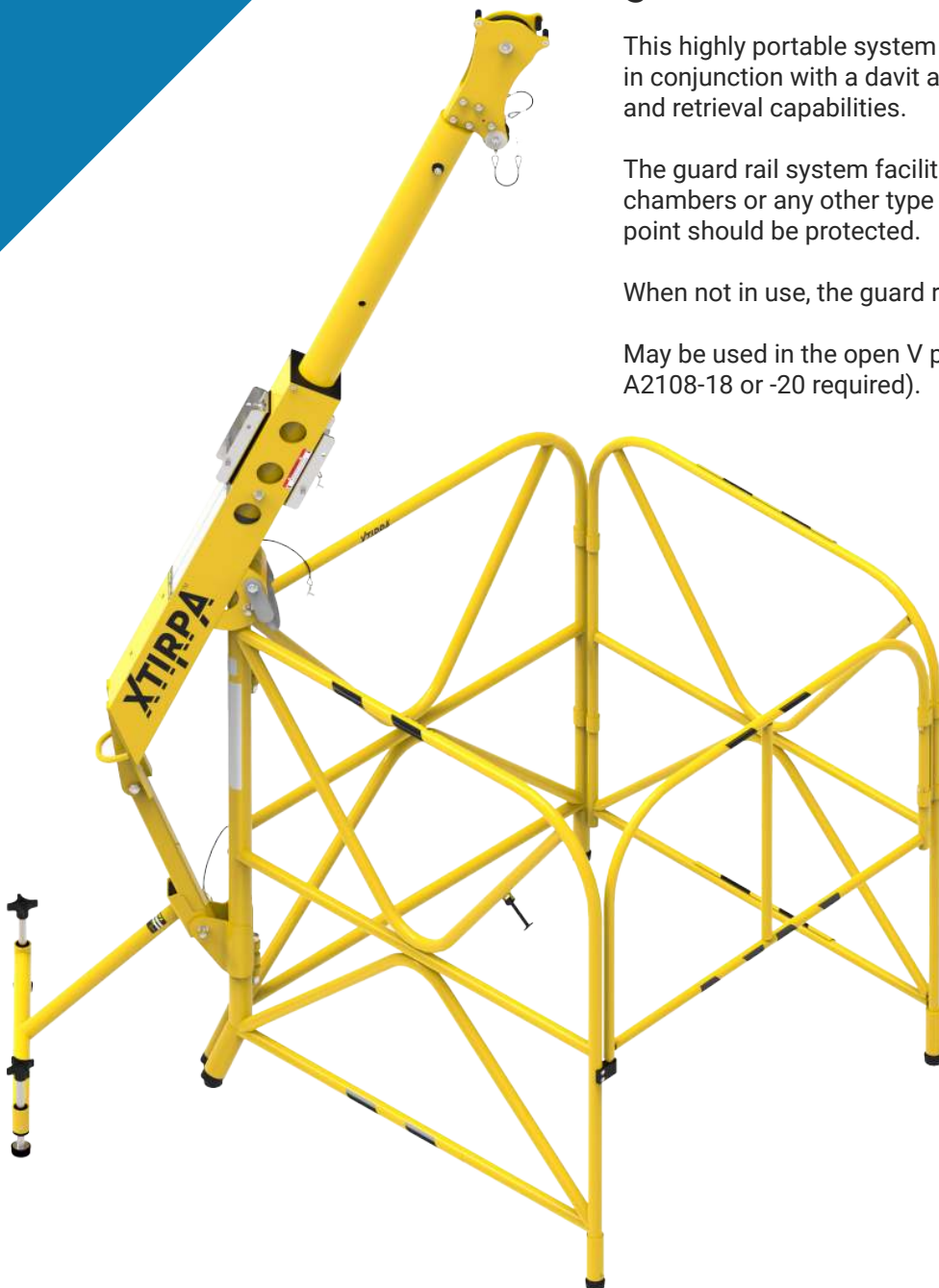



# Guard Rail Davit Bases



## IN-2108

Portable manhole guard with integrated mast and gate, used in conjunction with IN-2210 davit arm.



EN795

TS16415

Z359.1

Z259.2.1-98

1910.66 App C

### Product Specification

Dimensions (mm)	L 992 x W 947 x H 1133
Weight (kg)	15
Main Material	Aluminium



## IN-2324

Large portable manhole guard with integrated mast and gate. Used in conjunction with the IN-2210 davit arm.

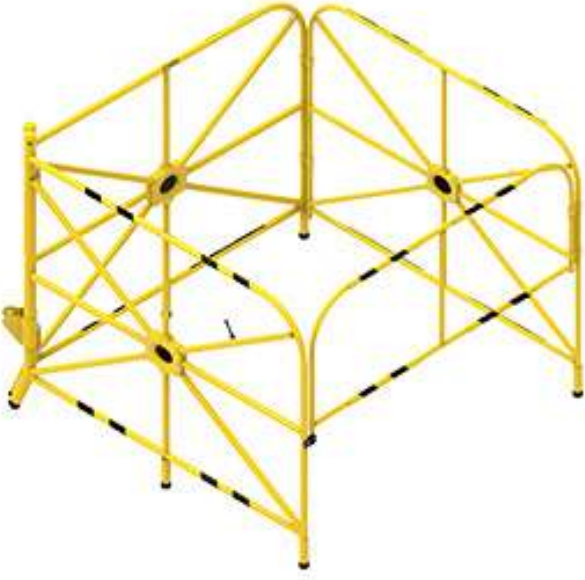

### Product Specification

Dimensions (mm)	L 1320 x W 1320 x H 1136
Weight (kg)	22
Main Material	Aluminium

## IN-2101

Multifunctional portable barricade allows worker to assemble additional sections as needed to create a safe working area.



### Product Specification

Dimensions (mm)	L 965 x W 965 X H 1068
Weight (kg)	12
Main Material	Aluminium



A2108-18



A2108-20



A2101-07



A2191-04

# Guard Rail Davit Kits

Guardrail Davit Kit 1



Guardrail Davit Kit 2



Guardrail Davit Kit 3

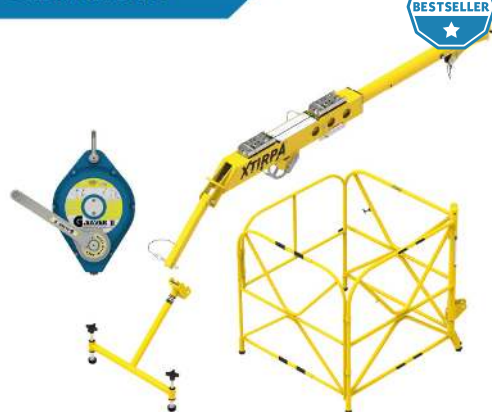

Guardrail Davit Kit 4



Guardrail Davit Kit 5



Guardrail Davit Kit 6



## Guardrail Davit Kits

	Kit 1	Kit 2	Kit 3	Kit 4	Kit 5	Kit 6
1067mm Manhole Guard with Mast	X	X	X	X	X	X
Manhole Guard Stabiliser			X	X	X	X
610mm Davit Arm	X	X	X	X	X	X
<b>G.Saver II 14m</b>	X	X	X	X		
<b>G.Saver II 20m</b>					X	
<b>G.Saver II 34m</b>						X
<b>G.Winch 20m</b>		X		X	X	
<b>G.Winch 40m</b>						X
Fall Arrest Bracket	X	X	X	X	X	X
Winch Bracket		X		X	X	X

# H-Base Davit System

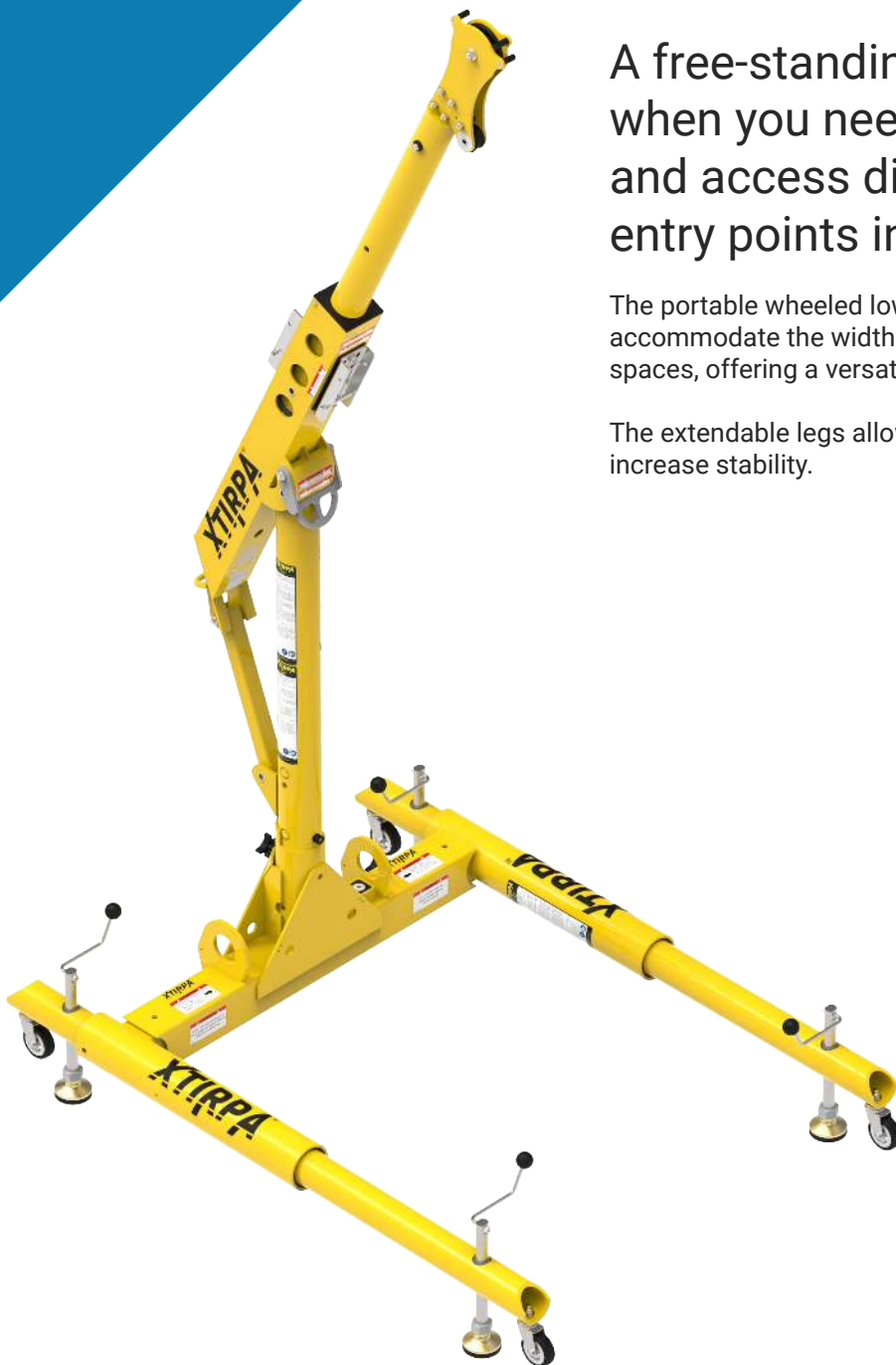

A free-standing system is ideal when you need to move the davit and access different confined space entry points in the same area.

The portable wheeled lower base allows for adjustment to accommodate the width and length of most standard confined spaces, offering a versatile confined space access solution.

The extendable legs allow for access to wider entries and increase stability.



# H-Base



EN795

TS16415

Z359.1

Z259.2.1-98

1910.66 App C

## IN-2118

Three-piece extendable H base that adjusts to fit most standard confined spaces. Castors make the base easy to relocate.

### Product Specification

Dimensions (mm)	L 1092-1689 x W 1473 x H 463-558
Weight (kg)	43
Main Material	Aluminium



# H-Base Davit Kits

H-Base Standard Davit Kit 1



H-Base Standard Davit Kit 2



H-Base Standard Davit Kit 3



H-Base Standard Davit Kit 4



## H-Base Kits

	Kit 1	Kit 2	Kit 3	Kit 4
1270mm H-Base	X	X	X	X
610mm Mast-Davit Arm				
IN-2210 610mm Davit Arm	X	X	X	X
IN-2003 Davit Mast	X	X	X	X
G.Saver II 14m	X	X		
G.Saver II 20m			X	
G.Saver II 34m				X
G.Winch 20m		X	X	
G.Winch 40m				X
Fall Arrest Bracket	X	X	X	X
Winch Bracket		X	X	X



# Pole Hoist System



## Horizontal entry to confined spaces.

A range of anchorages and pole hoists with adjustable lengths offer a versatile and dependable system for horizontal access and rescue.





# Pole Hoists

Pole hoist system with swivel-head for vertical and horizontal retrieval and fall arrest. Extends with two fixed angles. Use with a certified anchor point. Includes mounting bracket A2002-31.



## IN-2337



### Product Specification

Dimensions (mm)	L 1588-2032 x W 152 x H 285
Weight (kg)	10
Main Material	Aluminium



## IN-2338

### Product Specification

Dimensions (mm)	L 1869-2656 x W 152 x H 312
Weight (kg)	10
Main Material	Aluminium



EN795

Z359.1

Z259.2.1-98

1910.66 App C



OSHA



# T-Bars



## IN-2127

Adjustable T-bar attaches to swivel-head pole hoist IN-2337 or IN-2338 for base stability of the system.

Product Specification	
Dimensions (mm)	L 913-1218 x W 762 x H 51
Weight (kg)	4
Main Material	Aluminium



## IN-2256

Longer adjustable T-bar attaches to swivel-head pole hoist IN-2337 or IN-2338 for base stability of the system.

Product Specification	
Dimensions (mm)	L 1189-1900 x W 762 x H 51
Weight (kg)	4
Main Material	Aluminium



## IN-2274

Short adjustable T-bar attaches to swivel-head pole hoist IN-2337 or IN-2338 for base stability of the system.

Product Specification	
Dimensions (mm)	L 332-378 x W 752 x H 51
Weight (kg)	2
Main Material	Aluminium

EN795

Z359.1

Z259.2.1-98

1910.66 App C



# Pole Hoist Anchorages

## IN-2242



Anchor point for vertical and horizontal entry with the pole hoist system. Can be used on round or square flange.

### Product Specification

Dimensions (mm)	L 393.6 x W 286 x H 287
Weight (kg)	15
Main Material	Steel

## IN-2241



This jib adapter is positioned outside of the confined space's entry point allowing for lateral entry. Typically used with tanks when walls are too thin for anchoring.

### Product Specification

Dimensions (mm)	L 992 x W 830 x H 2260-2775
Weight (kg)	48
Main Material	Aluminium

## IN-2087



Universal ring adapter, use on ceiling or wall with pole hoist system. Use horizontally or vertically.

### Product Specification

Dimensions (mm)	L 317.5 x W 203 x H 111
Weight (kg)	6
Main Material	Stainless Steel



# Pole Hoist Kits

Pole Hoist Kit 1



Pole Hoist Kit 2



Pole Hoist Kit 3



Pole Hoist Kit 4



## Pole Hoist Kits

	Kit 1	Kit 2	Kit 3	Kit 4
IN-2127 T-Bar Leg	X	X	X	X
IN-2337 Pole Hoist Arm	X	X	X	X
Lateral Entry Adapter				X
G.Saver II 14m	X			X
G.Saver II 20m		X		
G.Saver II 34m			X	
Fall Arrest Bracket	X	X	X	X

# Swivelling Wall Plate

Used to install a fall arrester and/or winch below a pulley system for confined space access. Use with concrete walls.



## IN-2314

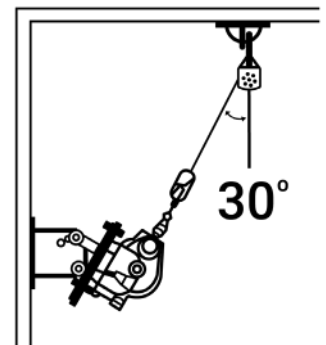

### Product Specification

Dimensions (mm)	L 229 x W 238 x H 330
Weight (kg)	21
Main Material	Stainless Steel

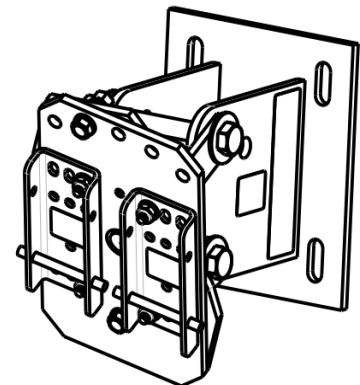
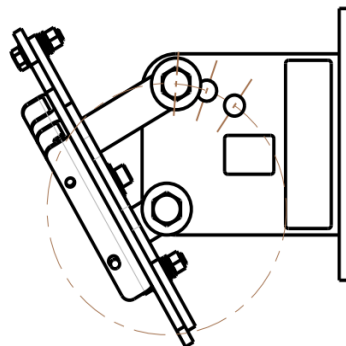
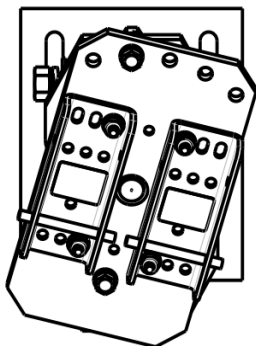

# Hitch Mount System

The hitch mount davit system provides a portable confined space access system with a hitch attachment for vehicles and other anchor points.



# Components



## IN-2204

Hitch mount with 1524mm wide stabiliser connects to 51mm square vehicle hitches. Comes with adjustable screw pads.

### Product Specification

Dimensions (mm)	L 1521 x W 1083 x H 612-801
Weight (kg)	20
Main Material	Aluminium

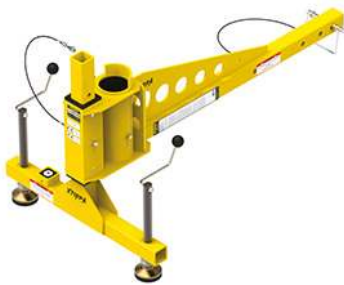

## IN-2126

Hitch mount with 610mm wide stabiliser connects to 51mm square vehicle hitches. Comes with adjustable screw pads.

### Product Specification

Dimensions (mm)	L 610 x W 1083 x H 612-762
Weight (kg)	15
Main Material	Aluminium



## A2126-10

This hitch mount extension attaches to hitch mount IN-2126 or IN-2204 and provides a 90° extension for hitch mount system.

### Product Specification

Dimensions (mm)	L 1321
Weight (kg)	28
Main Material	Steel



# Components & Clamps



## A2126-69

This mount extension attaches to hitch mount IN-2126 or IN-2204 and provides an additional 1008mm of length.

Product Specification	
Dimensions (mm)	L 1008
Weight (kg)	7.18
Main Material	Steel



## A2126-09

This mount extension attaches to hitch mount IN-2126 or IN-2204 and provides an additional 1829mm of length.

Product Specification	
Dimensions (mm)	L 1935
Weight (kg)	14
Main Material	Steel



## IN-2517

This adapter allows the hitch stabiliser systems to be used with the some types of European vehicle hitches.

Product Specification	
Dimensions (mm)	L 337 x W 102 x H 102
Weight (kg)	8
Main Material	Steel







## A2126-21

Portable anchor bolt adapter for hitch mount.

### Product Specification

Dimensions (mm)	H 518 x W 337 x L 159
Weight (kg)	16
Main Material	Steel



## A2126-14

406mm C-Clamp adapter

### Product Specification

Dimensions (mm)	H 736 x W 178 x L 171
Weight (kg)	17
Main Material	Steel



## A2126-33

597mm C-Clamp adapter (long)

### Product Specification

Dimensions (mm)	H 889 x W 178 x L 171
Weight (kg)	19
Main Material	Steel



## A2126-50

Short mezzanine C-Clamp adapter

### Product Specification

Dimensions (mm)	H 729 x W 667 x L 368
Weight (kg)	27
Main Material	Steel

EN795

Z359.1

Z259.2.1-98

1910.66 App C



# Hitch Mount Kits

Mezzanine Floor Clamp Kit 1



Portable Anchor Clamp Kit 1



Portable Anchor Clamp Kit 2



Vehicle Hitch Kit 1



Vehicle Hitch Kit 2



Vehicle Hitch Kit 3



<b>Hitch Mount Kits</b>	Mezzanine	Portable	
		Kit 1	Kit 2
A2126-50 C-Clamp	X		
A2126-33 C-Clamp		X	
A2126-21 Anchor Bolt			X
Hitchmount with 1524mm Stabiliser	X	X	X
A2126-69 Extension	X	X	X
IN-2210 610mm Davit Arm	X	X	X
IN-2003 Davit Mast	X	X	X
<b>G.Saver II</b> 14m	X	X	X
<b>G.Winch</b> 20m	X	X	X
Fall Arrest Bracket	X	X	X
Winch Bracket	X	X	X

<b>Vehicle Hitch Kits</b>	Kit 1	Kit 2	Kit 3
Hitchmount with 1524mm Stabiliser	X	X	X
A2126-69 Extension	X	X	X
European Vehicle Hitchmount	X	X	X
90° Extension			X
IN-2210 610mm Davit Arm	X	X	X
IN-2003 Davit Mast	X	X	X
<b>G.Saver II</b> 14m	X	X	X
<b>G.Winch</b> 20m		X	X
Fall Arrest Bracket	X	X	X
Winch Bracket		X	X

# Counterweight Davit System

A counterweight system is ideal when you need to move and access various confined spaces entry points in the same area.

Consisting of a central base unit with a number of options for anchoring, positioning, leg adjustment and extension, this is a system designed for versatility.



# Bases & Components



## IN-2525

Wheeled counterweight cart attaches to T-base IN-2305 via an extension. Castors enable easy movement.

Product Specification	
Dimensions (mm)	L 1308 x W 1206 x H 1090-1281
Weight (kg)	220
Main Material	Steel & Aluminium

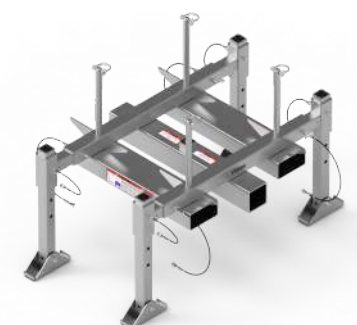

## A2305-90

Static counterweight cart attaches to T-base IN-2305 via an extension. Features forklift slots for lifting.

Product Specification	
Dimensions (mm)	L 1181-1257 x W 813 x H 637-870
Weight (kg)	84
Main Material	Zinc Plated Steel



## IN-2305

Portable T-base for confined space fall arrest and retrieval. Attaches to counterweight cart via extensions A2305-16 or -40. Castors enable easy movement.

Product Specification	
Dimensions (mm)	L 1740 x W 559 x H 475
Weight (kg)	33
Main Material	Aluminium



## A2305-25



Reducer for 1829mm extension.

### Product Specification

Dimensions (mm)	L 456 x W 87.4 x H 87.4
Weight (kg)	7

## A2305-16



1829mm extension connects to T-base IN-2305 using reducer A2305-25.

### Product Specification

Dimensions (mm)	L 2023 x W 5.4 x H 5.4
Weight (kg)	22

## A2305-40



2438mm extension tube for counterweight T-base.

### Product Specification

Dimensions (mm)	L 2438
Weight (kg)	44

## P2525-017



Weight plate for counterweight trolley or support.  
Number of plates required varies. 50lbs / 22.68kg

### Product Specification

Dimensions (mm)	L 406 x W 305 x H 25.4
Weight (kg)	22.7



## A2305-53

Adjustable height leg

# Wheeled Cart 610 Counterweight Kits

Wheeled Cart 610 Counterweight Kit 1



Wheeled Cart 610 Counterweight Kit 2



Wheeled Cart 610 Counterweight Kit 3



Wheeled Cart 610 Counterweight Kit 4



Wheeled Cart 610 Counterweight Kit 5



Wheeled Cart 610 Counterweight Kit 6



Wheeled Cart 610 Counterweight Kit 7



Wheeled Cart 610 Counterweight Kit 8



# Static Cart 610 Counterweight Kits

Static Cart 610 Counterweight Kit 1



Static Cart 610 Counterweight Kit 2



Static Cart 610 Counterweight Kit 3



Static Cart 610 Counterweight Kit 4



# Water Counterweight Kits

Water Counterweight Kit 1





# Wheeled Cart 1200 Counterweight Kits

Wheeled Cart 1200 Counterweight Kit 1



Wheeled Cart 1200 Counterweight Kit 2



Wheeled Cart 1200 Counterweight Kit 3



# Static Cart 1200 Counterweight Kits

Static Cart 1200 Counterweight Kit 1



Static Cart 1200 Counterweight Kit 2



Static Cart 1200 Counterweight Kit 3



# Counterweight Davit Kits



## Wheeled Cart 610 Counterweight Kits

	Kit 1	Kit 2	Kit 3	Kit 4	Kit 5	Kit 6	Kit 7	Kit 8
Hitchmount with 1524mm Stabiliser	X	X	X	X	X	X	X	X
A2126-69 Extension	X	X	X	X				
Counterweight Base Adapter 51-89mm	X	X	X	X	X	X	X	X
Counterweight Trolley	X	X	X	X	X	X	X	X
50lbs Weight Plate	10x	10x	10x	10x	19x	19x	19x	19x
IN-2210 610mm Davit Arm	X	X	X	X	X	X	X	X
IN-2003 Davit Mast	X	X	X	X	X	X	X	X
G.Saver II 14m	X	X			X	X		
G.Saver II 20m			X		X		X	
G.Saver II 34m				X				X
G.Winch 20m		X	X			X	X	
G.Winch 40m				X				X
Fall Arrest Bracket	X	X	X	X	X	X	X	X
Winch Bracket		X	X	X		X	X	X

<b>Static Cart 610 Counterweight Kits</b>	<i>Kit 1</i>	<i>Kit 2</i>	<i>Kit 3</i>	<i>Kit 4</i>
Hitchmount with 1524mm Stabiliser	X	X	X	X
A2126-69 Extension	X	X	X	X
Counterweight Base 51-89mm	X	X	X	X
Counterweight Support	X	X	X	X
50lbs Weight Plate	<b>14x</b>	<b>14x</b>	<b>14x</b>	<b>14x</b>
IN-2210 610mm Davit Arm	X	X	X	X
IN-2003 Davit Mast	X	X	X	X
<b>G.Saver II</b> 14m	X	X		
<b>G.Saver II</b> 20m			X	
<b>G.Saver II</b> 34m				X
<b>G.Winch</b> 20m		X	X	
<b>G.Winch</b> 40m				X
Fall Arrest Bracket	X	X	X	X
Winch Bracket		X	X	X

<b>1200 Counterweight Kits</b>	<b>Wheeled</b>			<b>Static</b>			<b>Water</b>
	<i>Kit 1</i>	<i>Kit 2</i>	<i>Kit 3</i>	<i>Kit 1</i>	<i>Kit 2</i>	<i>Kit 3</i>	
Universal T-Base	X	X	X	X	X	X	X
A2305-40 Extension	X	X	X	X	X	X	X
Counterweight Trolley	X	X	X				
Counterweight Support				X	X	X	
Counterweight Bladder System							X
50lbs Weight Plate	<b>23x</b>	<b>23x</b>	<b>23x</b>	<b>28x</b>	<b>28x</b>	<b>28x</b>	
761-1219mm Extendable Davit Arm	X	X	X	X	X	X	X
IN-2240 Davit Mast	X	X	X	X	X	X	X
<b>G.Saver II</b> 14m	X			X			X
<b>G.Saver II</b> 20m		X			X		
<b>G.Saver II</b> 34m			X			X	
<b>G.Winch</b> 20m	X	X		X	X		
<b>G.Winch</b> 40m			X			X	X
Fall Arrest Bracket	X	X	X	X	X	X	X
Winch Bracket	X	X	X	X	X	X	X

# Manhole Collar System

Manhole collar bases are designed for applications involving frequent set ups over circular openings.

This lightweight and easy to assemble system provides a portable base and certified anchor point. An ideal option for areas where a permanent anchor is not viable.

A wide range of sizes and accessories are available.



# Manhole Collar Base

Standard

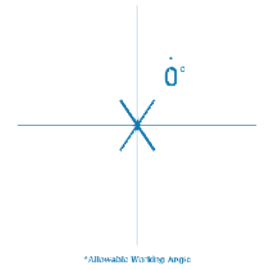

**IN-2287**  
406 - 457mm  
Diameter



**IN-2219**  
457 - 508mm  
Diameter

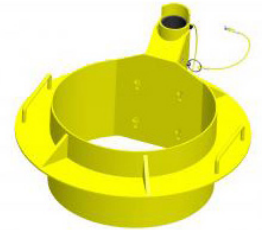

**IN-2220**  
508 - 559mm  
Diameter

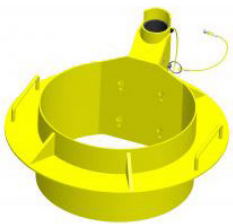

**IN-2221**  
559 - 610mm  
Diameter



**IN-2217**  
610 - 660mm  
Diameter



**IN-2222**  
660 - 711mm  
Diameter



**IN-2218**  
711 - 762mm  
Diameter



**IN-2167**  
762 - 813mm  
Diameter



**IN-2223**  
813 - 864mm  
Diameter



**IN-2224**  
864 - 914mm  
Diameter



**IN-2476**  
914 - 965mm  
Diameter

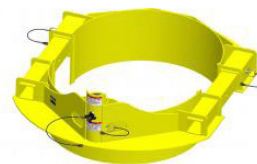

**IN-2269**  
813 - 1067mm  
Diameter



**IN-2180**  
1080 - 1118mm  
Diameter

EN795

TS16415

Z359.1

Z259.2.1-98

1910.66 App C



OSHA



# Manhole Collar Base

Adjustable Angle

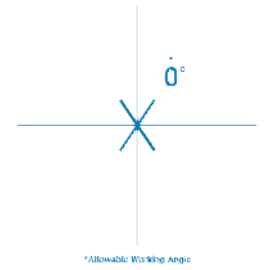

**IN-2496**

457 - 508mm  
Diameter  
0 - 30°



**IN-2497**

508 - 559mm  
Diameter  
0 - 30°



**IN-2490**

559 - 610mm  
Diameter  
0 - 30°



**IN-2475**

610 - 660mm  
Diameter  
0 - 45°



**IN-2498**

610 - 660mm  
Diameter  
0 - 30°



**IN-2499**

610 - 660mm  
Diameter  
0 - 30°



**IN-2500**

711 - 762mm  
Diameter  
0 - 30°



**IN-2487**

762 - 813mm  
Diameter  
0 - 30°

EN795

TS16415

Z359.1

Z259.2.1-98

1910.66 App C



OSHA



# Manhole Collar Base

Anodised

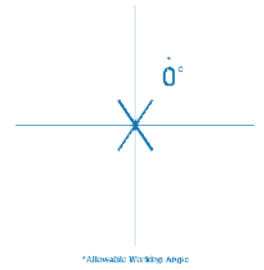

**IN-2486P**

406 - 456mm  
Diameter  
0 - 30°



**IN-2496P**

457 - 508mm  
Diameter  
0 - 30°



**IN-2497P**

508 - 559mm  
Diameter  
0 - 30°



**IN-2490P**

559 - 610mm  
Diameter  
0 - 30°



**IN-2498P**

610 - 660mm  
Diameter  
0 - 30°



**IN-2499P**

610 - 660mm  
Diameter  
0 - 30°



**IN-2500P**

711 - 762mm  
Diameter  
0 - 30°



**IN-2487P**

762 - 813mm  
Diameter  
0 - 30°

EN795

TS16415

Z359.1

Z259.2.1-98

1910.66 App C



OSHA



# Manhole Collar Base

Non Standard

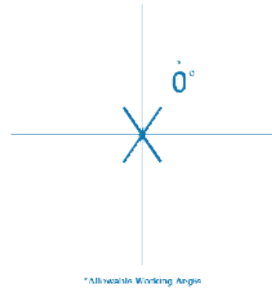

**IN-2504**

597 - 648mm  
Splittable Manhole  
Collar (0 - 45°)  
Non-CE



**IN-2534**

400 - 600mm  
Rectangular Manhole  
Collar

# Manhole Collar Accessories



**IN-2009**

762mm Cone  
Shaped Safety Ring



**IN-2543**

699mm Cone  
Shaped Safety Ring



**IN-2010**

Manhole Retaining  
Ring



**A2217-05**

Ladder Adapter for  
Manhole Collar



**A2217-10**

Manhole Collar  
Seat



**IN-2244**

Positioning Seat



**A2475-05**

Manhole Collar  
Stabiliser



# Manhole Collar Kits

Standard



Manhole Collar Kit 1



Manhole Collar Kit 2



Manhole Collar Kit 3



Manhole Collar Kit 4



Manhole Collar Kit 5



Manhole Collar Kit 6



Manhole Collar Kit 7



# Manhole Collar Kits

Anodised

Anodised Manhole Collar Kit 1



Anodised Manhole Collar Kit 2



Anodised Manhole Collar Kit 3



Anodised Manhole Collar Kit 4



## Manhole Collar Kits

	Kit 1	Kit 2	Kit 3	Kit 4	Kit 5	Kit 6	Kit 7
457-508mm Manhole Collar	X						
508-559mm Manhole Collar		X					
559-610mm Manhole Collar			X				
600-711mm Manhole Collar				X			
508mm 0-30° Manhole Collar					X		
559mm 0-30° Manhole Collar						X	
610mm 0-30° Manhole Collar							X
IN-2395 Mast-Davit Arm	X	X	X	X	X	X	X
G.Saver II 14m	X	X	X	X	X	X	X
G.Winch 20m	X	X	X	X	X	X	X
Fall Arrest Bracket	X	X	X	X	X	X	X
Winch Bracket	X	X	X	X	X	X	X
Offset Winch Adapter	X	X	X	X	X	X	X

## Anodised Manhole Collar Kits

	Kit 1	Kit 2	Kit 3	Kit 4
457mm 0-30° Manhole Collar (Anodised)	X			
508mm 0-30° Manhole Collar (Anodised)		X		
559mm 0-30° Manhole Collar (Anodised)			X	
610mm 0-30° Manhole Collar (Anodised)				X
IN-2395P Mast-Davit Arm	X	X	X	X
G.Saver II 14m	X	X	X	X
G.Winch 20m	X	X	X	X
Fall Arrest Bracket	X	X	X	X
Winch Bracket	X	X	X	X
Offset Winch Adapter	X	X	X	X



# Fall Arrest Post



## IN-2104

Fall arrest mast, certified for three people. Equipped with swivel anchors allowing for 360° movement, and adjustable height.

### Product Specification

Dimensions (mm)	L 229 x W 229 x H 1107-1580
Weight (kg)	24
Main Material	Aluminum

## A2102-03

Fall arrest post anchorage base, secures fall arrest mast into position with M20x200 bolts or by welding.  
*Anchor bolts not included.*



### Product Specification

Dimensions (mm)	L 305 x W 305 x H 107
Weight (kg)	16
Main Material	Zinc Plated

# Fall Arrest Post Kits

Fall Arrest Post Kit 1



Fall Arrest Post Kit 2



Fall Arrest Post Kit 3



## Fall Arrest Post Kits

	Kit 1	Kit 2	Kit 3
Portable Fall Arrest Post	X	X	X
Anchorage Plate	X	2x	X
G.Autoreel 2.5m	X	X	2x



# Anchor Device for Drilling



## A5032-01

Anchor post. Installs on to the insertion mast. A lifeline may be tensioned between two posts to create a horizontal lifeline system.

Product Specification	
Dimensions (mm)	ø 79.4 x H 1067
Weight (kg)	13.6
Main Material	Steel



## A5032-07

Self retracting lifeline support. Installs on to anchor post A5032-01.

Product Specification	
Dimensions (mm)	L 203 x W 102 x H 268
Weight (kg)	61
Main Material	Steel



## A5032-35

Product Specification	
Diameter $\varnothing$ (mm)	89
Height (mm)	1346
Weight (KG)	16



## A5032-40

Product Specification	
Diameter $\varnothing$ (mm)	102
Height (mm)	1346
Weight (KG)	14



## A5032-45

Product Specification	
Diameter $\varnothing$ (mm)	114
Height (mm)	1346
Weight (KG)	16



## A5032-50

Product Specification	
Diameter $\varnothing$ (mm)	127
Height (mm)	1346
Weight (KG)	18



## A5032-55

Product Specification	
Diameter $\varnothing$ (mm)	140
Height (mm)	1346
Weight (KG)	21



## A5032-60

Product Specification	
Diameter $\varnothing$ (mm)	152
Height (mm)	1346
Weight (KG)	23



## A5032-65

Product Specification	
Diameter $\varnothing$ (mm)	165
Height (mm)	1346
Weight (KG)	25



## A5032-80

Product Specification	
Diameter $\varnothing$ (mm)	203
Height (mm)	1346
Weight (KG)	21

# XLT Davit System



## IN-5039

4572 to 7620 mm adjustable mast and davit arm. 1829 mm reach, horizontal rail, trolley for self-retracting lifeline, locking mechanism, height adjustment crank, self-retracting lifeline adapter and adapter for optional winch. For use when working on elevated platforms.



164kg

MWL

EN795

Z359.1

Z259.2.1-98

1910.66 App C

### Product Specification

Dimensions (mm)	L 1829 x W 394 x H 4572-7620
Weight (kg)	286
Main Material	Steel







## IN-5040

### Central Floor Base

Product Specification	
Dimensions (mm)	H 467 x W 432 x L 432
Weight (kg)	61
Main Material	Steel

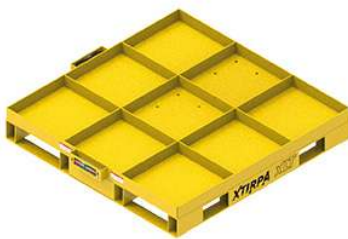

## A5039-12

### Transport Base (with forklift slots)

Product Specification	
Dimensions (mm)	H 216 x W 1372 x L 1372
Weight (kg)	244
Main Material	Steel



## A5039-17

### Concrete Blocks (Set of 8)

Product Specification	
Dimensions (mm)	H 699 x W 441 x L 441
Weight (kg)	315
Main Material	Concrete

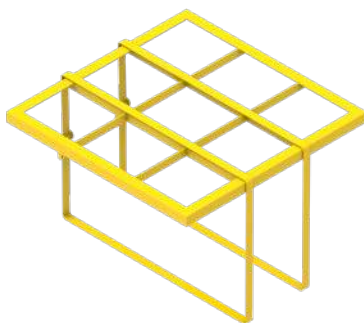

## A5039-46

### Retention Grid for concrete blocks

Product Specification	
Dimensions (mm)	H 63.5 x W 1371 x L 1371
Weight (kg)	41
Main Material	Steel

# XLT Davit Accessories



A5039-45

Set of Bolts for XLT Base



A5039-57

Concrete Moulds

# XLT Davit System Kits

XLT Fixed Mast Kit 1



XLT Mobile Mast Kit 1



## XLT Mast Kits

	Fixed	Mobile
4.6m XLT Mast-Davit Arm	X	X
Floor Base	X	X
8x Concrete Blocks		X
Retention Grid		X
Travel Base		X
<b>G.Stop</b> 14m	X	X
<b>G.Saver</b> 20m	X	X
Fall Arrest Bracket	X	X



# Manhole Cover Lifter



## IN-2071

For easy handling of manhole covers. The ratchet system offers an ergonomically safe way to lift the toughest lids with less strain.

Product Specification	
Dimensions (mm)	H 1346 x W 216 x D 493
Weight (kg)	6
Main Material	Aluminium

# Manhole Cover Hooks & Webbing

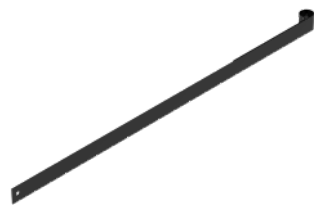

**P2018-016**

Webbing for Manhole  
Cover Lifter



**P2071-032P**

Lifter Hook for 32mm  
Hole



**P2071-026P**

Medium Square Hook  
(High Profile)

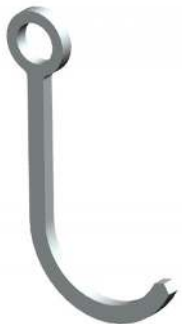

**P2071-023P**

Large J Hook



**P2071-022P**

Medium Square Hook  
(Low Profile)



**P2071-021P**

Small J Hook



**P2071-018**

Standard Manhole  
Cover Hook

# Ladder Adapters



## A2217-17

Adapter for 190mm Ladder

Product Specification	
Dimensions (mm)	L 292 x W 156 x H 457
Weight (kg)	4
Main Material	Aluminium



## A2217-25

Adapter with Locking System

Product Specification	
Dimensions (mm)	L 292 x W 171 x H 584
Weight (kg)	6
Main Material	Aluminium



## A2217-36

Adapter with Centred Locking System

Product Specification	
Dimensions (mm)	L 356 x W 235 x H 533
Weight (kg)	6
Main Material	Aluminium

## 610 Davit



**IN-2072**

Base Cap



**A2395-06**

559mm Extension



**A2395-12**

1016mm Extension



**A2395-06P**

559mm Extension  
(Anodised)



**A2395-12P**

1016mm Extension  
(Anodised)

## 1200 Davit

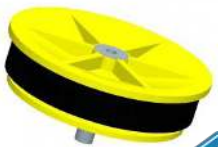

**IN-2272**

Base Cap



**A2237-06**

Removable Winch  
Adapter

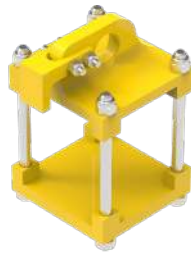

**A2237-17**

Auxillary Anchor  
Point



**A2238-03**

102mm to 76mm  
Cylinder Reducer

## 2450 Davit



**A2201-04**

140mm to 102mm  
Cylinder Reducer

# Davit Accessories

# Recovery Device Brackets



**GSEABX14**

G.Saver II 14m



**GSEABX20**

G.Saver II 20m



**GSEABX34**

G.Saver II 34m



**IN-2374**

IKAR HRA-12



**IN-2375**

IKAR HRA-18



**IN-2376**

IKAR HRA-24



**IN-2377**

IKAR HRA-33



**IN-2378**

IKAR HRA-42



**IN-2152**

Protecta AD515





**IN-2153**

Miller 15m



**IN-2177**

Miller 30m



**IN-2404**

MSA Workman  
Rescuer

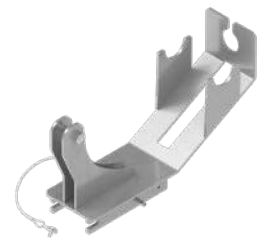

**IN-2424**

Blocfor 20R



**IN-2425**

Blocfor 30R

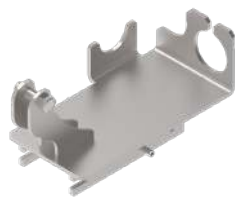

**IN-2539**

Protekt CRW200



**IN-2538**

Protekt CRW300



**IN-2540**

Kratos Olympe

## Winch Brackets



**GSE200WBX**

G.Winch



**IN-2191**

Miller Manhandler



**IN-2464**

Harken Lokhead



**IN-2211**

IKAR PLW  
ISC RW020  
Protekt 502 / 503

# Index

<b>#</b>			
070k.....	27		
107k.....	27		
1080-01.....	27		
1080-03.....	27		
2450-DAVIT-KITS.....	56		
<b>A</b>			
A2101-07.....	66		
A2102-03.....	100		
A2108-18.....	66		
A2108-20.....	66		
A2126-09.....	80		
A2126-10.....	79		
A2126-14.....	81		
A2126-21.....	81		
A2126-33.....	81		
A2126-50.....	81		
A2126-69.....	80		
A2191-04.....	66		
A2201-04.....	111		
A2217-05.....	96		
A2217-10.....	96		
A2217-17.....	110		
A2217-25.....	110		
A2217-36.....	110		
A2237-06.....	111		
A2237-17.....	111		
A2238-03.....	111		
A2305-16.....	86		
A2305-25.....	86		
A2305-40.....	86		
A2305-53.....	86		
A2305-90.....	85		
A2395-06.....	111		
A2395-06P.....	111		
A2395-12.....	111		
A2395-12P.....	111		
A2475-05.....	96		
A5032-01.....	102		
A5032-07.....	102		
A5032-35.....	103		
A5032-40.....	103		
A5032-45.....	103		
A5032-50.....	103		
A5032-55.....	103		
A5032-60.....	103		
A5032-65.....	103		
A5032-80.....	103		
A5039-12.....	105		
A5039-13.....	105		
A5039-45.....	106		
A5039-46.....	105		
A5039-57.....	106		
<b>C</b>			
COMPACT-TRIPOD-KITS.....	14		
COUNTERWEIGHT-KITS.....	87,88,89		
<b>F</b>			
FALL-ARREST-POST-KITS.....	101		
FLOOR-MOUNT-DAVIT-1200-KITS.....	52		
FLOOR-MOUNT-DAVIT-610-KITS.....	44		
FLUSH-FLOOR-1200-KITS.....	53		
<b>G</b>			
GSE070-136-20SSK.....	19		
GSE070-136-40SSK.....	19		
GSE070-136-50SSK.....	19		
GSE070-200-20SSK.....	19		
GSE070-200-40SSK.....	19		
GSE070-250-20G.....	19		
GSE070-250-40G.....	19		
GSE070250USP.....	19		
GSE070USP.....	19		
GSE1000-10G.....	29		
GSE1050.....	27		
GSE1050SC.....	27		
GSE1081-04.....	15		
GSE1301B.....	22		
GSE1302B.....	23		
GSE1303B.....	22		
GSE1304B.....	23		
GSE1305B.....	23		
GSE1360.....	24		
GSE1361.....	24		
GSE1362.....	25		
GSE200WB.....	15		
GSE210LMB.....	15		
GSE210UMB.....	15		
GSE230AB14.....	15		
GSE230AB20.....	15		
GSE230AB34.....	15		
GSE230C.....	10		
GSE230S.....	10		
GSE300-10G.....	29		
GSE300-15G.....	29		
GSE300-20G.....	29		
GSE300-25G.....	29		
GSE414G.....	16		
GSE414SSK.....	16		
GSE420G.....	16		
GSE420SSK.....	16		
GSE434G.....	16		
GSE434SSK.....	16		
GSE500-10G.....	29		
GSE500-15G.....	29		
GSE500-20G.....	29		
GSE500-24G.....	29		
GSE507G.....	26		
GSE514G.....	26		
GSE520G.....	26		
GSE528G.....	26		
GSE534G.....	26		
GUARD-RAIL-DAVIT-KITS.....	67		
<b>H</b>			
H-BASE-DAVIT-KITS.....	70		
HITCH-MOUNT-KITS.....	82		
<b>I</b>			
IN-2003.....	34		
IN-2005.....	36		
IN-2006.....	36		
IN-2007.....	36		
IN-2008.....	38, 59		
IN-2009.....	96		
IN-2010.....	96		
IN-2013.....	36		
IN-2021.....	38, 59		
IN-2044.....	34		
IN-2045.....	34		
IN-2067.....	36		
IN-2071.....	108		
IN-2072.....	111		
IN-2075.....	38, 59		
IN-2085.....	36		

IN-2087.....	75	IN-2315.....	38, 59	IN-2546.....	55
IN-2097.....	36	IN-2324.....	66	IN-5039.....	104
IN-2101.....	66	IN-2325.....	37	IN-504.....	105
IN-2104.....	100	IN-2326.....	37		
IN-2105.....	36	IN-2327.....	37	<b>H</b>	
IN-2106.....	35	IN-2329.....	37	MANHOLE-COLLAR-KITS.....	97, 98
IN-2107.....	35	IN-2337.....	73		
IN-2108.....	65	IN-2338.....	73	<b>P</b>	
IN-2109.....	34	IN-2363.....	33	P2018-016.....	109
IN-2114.....	35	IN-2374.....	112	P2071-018.....	109
IN-2118.....	69	IN-2375.....	112	P2071-021P.....	109
IN-2124.....	36	IN-2376.....	112	P2071-022P.....	109
IN-2125.....	38, 59	IN-2377.....	112	P2071-023P.....	109
IN-2126.....	79	IN-2378.....	112	P2071-026P.....	109
IN-2127.....	74	IN-2380.....	49, 60	P2071-026P.....	109
IN-2129.....	38, 59	IN-2383.....	48	P2071-032P.....	109
IN-2137.....	35	IN-2395.....	33	P2525-017.....	86
IN-2152.....	112	IN-2404.....	113	POLE-HOIST-KITS.....	76
IN-2153.....	113	IN-2414.....	55		
IN-2167.....	93	IN-2420.....	55	<b>S</b>	
IN-2177.....	113	IN-2424.....	113	SA200WBX.....	113
IN-2180.....	93	IN-2425.....	113	STANDARD-DAVIT-610-KITS.....	40
IN-2191.....	113	IN-2426.....	47	STANDARD-DAVIT-1200-KITS.....	51
IN-2197.....	54	IN-2451.....	47	STANDARD-TRIPOD-KITS.....	12, 13
IN-2199.....	55	IN-2452.....	47		
IN-2201.....	55	IN-2464.....	113	<b>T</b>	
IN-2204.....	79	IN-2468.....	47	TRENCH-DAVIT-1200-KITS.....	50, 63
IN-2210.....	32	IN-2470.....	55	TRENCH-DAVIT-610-KITS.....	43, 61
IN-2211.....	113	IN-2475.....	94	TRENCH-DAVIT-610-HIRE-KITS.....	41
IN-2217.....	93	IN-2476.....	93		
IN-2218.....	93	IN-2482.....	38, 59	<b>W</b>	
IN-2219.....	93	IN-2483.....	33	WALL-MOUNT-DAVIT-1200-KITS.....	53
IN-2220.....	93	IN-2486P.....	95	WALL-MOUNT-DAVIT-610-KITS.....	39
IN-2221.....	93	IN-2487.....	94		
IN-2222.....	93	IN-2487P.....	95	<b>X</b>	
IN-2223.....	93	IN-2490.....	94	XLT-DAVIT-KITS.....	106
IN-2224.....	93	IN-2490P.....	95		
IN-2237.....	46	IN-2496.....	94		
IN-2238.....	48	IN-2496P.....	95		
IN-2240.....	47	IN-2497.....	94		
IN-2241.....	75	IN-2497P.....	95		
IN-2242.....	75	IN-2498.....	94		
IN-2244.....	96	IN-2498P.....	95		
IN-2251.....	38, 59	IN-2499.....	94		
IN-2253.....	48	IN-2499P.....	95		
IN-2254.....	48	IN-2500.....	94		
IN-2255.....	48	IN-2500P.....	95		
IN-2256.....	74	IN-2504.....	96		
IN-2266.....	48	IN-2516.....	48		
IN-2269.....	93	IN-2517.....	80		
IN-2272.....	111	IN-2525.....	85		
IN-2274.....	74	IN-2527.....	49		
IN-2287.....	93	IN-2528.....	49		
IN-2302.....	49	IN-2529.....	49		
IN-2303.....	49	IN-2534.....	96		
IN-2304.....	49	IN-2538.....	113		
IN-2305.....	85	IN-2539.....	113		
IN-2311.....	37	IN-2540.....	113		
IN-2313.....	47	IN-2543.....	96		
IN-2314.....	77	IN-2544.....	55		

October 2021  
PL: 33, Issue 04

Globestock Ltd. reserve the right to change specifications without prior notice.  
All information herein is copyright protected by Globestock Ltd. 2021.



Engineering Protection Since 1982