



GASPARDO

Growing Together



PRIMO FERTILIZER SPREADER

HIGH SPREADING PERFORMANCE

The fertilization of crops is a fundamental step to ensure an effective vegetative response and an optimal yield. The dosage of nutrients must be well calibrated and homogeneous to avoid product waste or damage to crops. MASCHIO GASPARDO presents the PRIMO range, the new double disc centrifugal fertilizer spreader: thanks to intuitive adjustments and reduced maintenance it is always ready for use for optimal crop yield.



CONTENTS

Great capacity	4
Quality spreading	6
PRIMO M	8
PRIMO E/EW	9
PRIMO E/EW ISOTRONIC	10
Precision farming	11
Designed to give the best	12
Adjustment via APP	13
Terminals	14
Accessories	15



ADVANTAGES OF THE PRIMO FERTILIZER SPREADER RANGE



- *Easy and intuitive adjustment*
- *Precise and even spreading*
- *Homogeneous crop growth*
- *Effective control of distribution along ditches and headlands*

Great capacity

PRIMO is the MASCHIO GASPARDO flagship model for fertilization operations. The PRIMO range is available in three versions: PRIMO M (with manual distribution control), PRIMO E (with continuous electronic distribution control) and PRIMO EW (with electronic distribution control and continuous weighing). The E-EW versions are also available in the ISOTRONIC version, with ISOBUS communication protocol. PRIMO is very versatile: it is available with transport widths of 253 and 285 cm, loading heights from 109 to 154 cm and a maximum volume ranging from 1270 l to 3210 l. For all models the maximum capacity is 3200 kg.

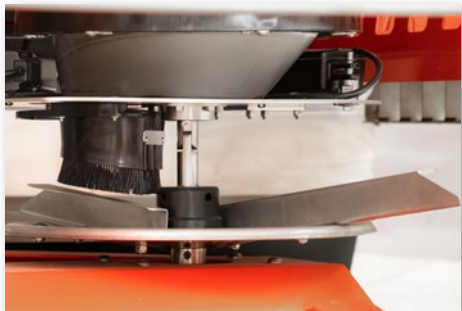

Adjustable delivery point

Thanks to the possibility to adjust the fertilizer delivery point on the spreading disc, it is possible to act in a simple, effective and intuitive way on the working width, optimizing the distribution quality.



Deflector for edge spreading (PATENTED)

Optional kit to fertilize close to headlands or streams without loss of product or contamination, limiting the width of the spread radius.



No more meter effect

The meter effect is a consequence of varying the speed of the tractor which forces you to change the spreading settings as the product flow varies. In the PRIMO fertilizer spreader, the phenomenon is eliminated thanks to a special shape of the shutter that allows for constant distribution in all dosing conditions.



Hopper inspection ladder (optional)

Tool supplied for changing discs

Total control

Waterproof hopper cover sheet

Up to 3 extensions are available to change the load capacity



Mud flap kit
(optional on M version)

Light kit and
dimension panels



Spreading disc and vanes

2 discs are available depending on the required working width (12-21 and 21-36 m).



PRIMO M shutter management

In this model the quantity of product dispensed is manually adjustable.



PRIMO E-EW dose shutter management (also ISOTRONIC)

The quantity of product dispensed is set directly by the terminal in the cab which manages the electric actuators.

Brush unit

A fertilizer conveyor is mounted in both discharge openings, the bristles of which brush against the upper edge of the spreading vanes, ensuring that the fertilizer is correctly channelled onto the disc.



Quality spreading



The PRIMO fertilizer spreader has been designed in an intelligent way: to vary the working width, no adjustment of the disc vanes or use of tools is required.

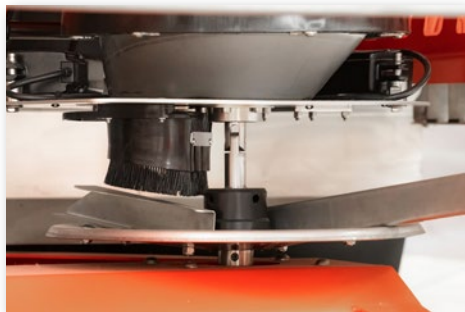

Distribution conveyor

The distribution conveyor allows you to limit the area where the product is poured onto the disc. This way the fertilizer always falls in the desired position: maximum precision to prevent any possible turbulence.

Disc replacement

The support of the single distribution disc is equipped with a (patented) quick release system to allow the operator to intervene quickly to replace the disc. This simple and intuitive operation requires only the supplied tool.

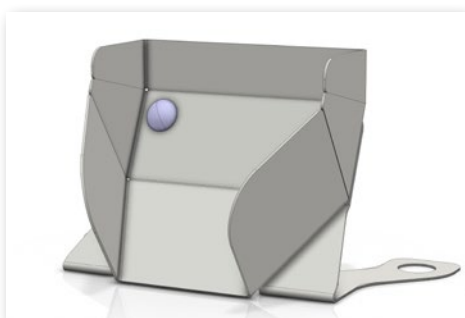
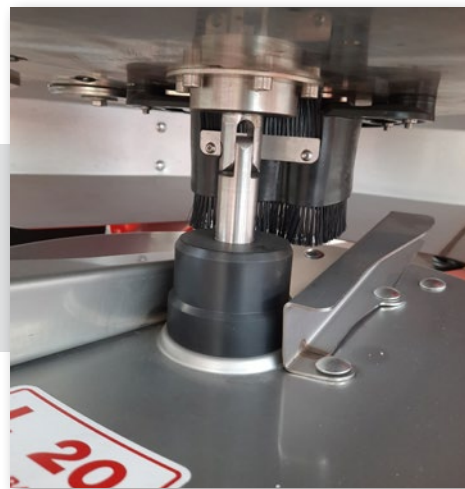

Fast fertilizer discharge

At the end of the work, a special chute can be placed under the discharge openings that allows you to unload any fertilizer left in the hopper. This accessory can also be used to perform fertilizer flow tests.

High precision fertilizer spreader



Proven quality

Laboratory tests confirm that the quality of the PRIMO range is close to ideal spreading values.

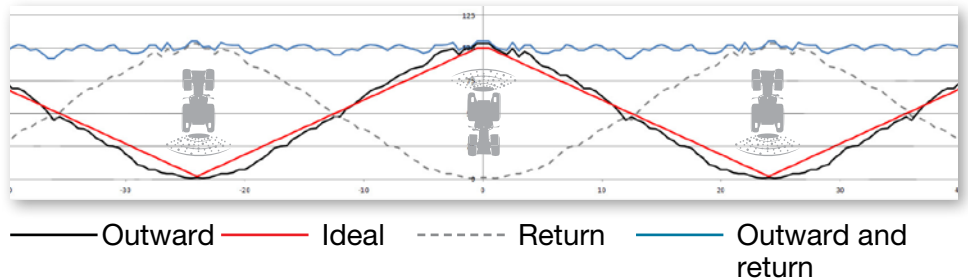

Rotating and vibrating shaker

The multi-arm head has a shape designed to convey the fertilizer towards the distribution system. Inside it, the “idle wheel” system prevents excessive rotation, avoiding product breakage and damage to the head in the presence of foreign bodies.

Eccentric shaker

The eccentric shaft that moves the shaker facilitates the rapid flow of the fertilizer towards the distribution chute making the flow more uniform.



Distribution discs

Each disc is obtained by moulding to guarantee a uniform surface. The vanes are made of stainless steel, resistant to the abrasive action of the fertilizer for greater durability and efficiency. Two spreading discs are available: one for working widths from 12 to 21 meters and one from 21 to 36 meters.

PRIMO M

Manual distribution control

Simplified mechanics

PRIMO M, with manual distribution control, was designed to be practical and effective. The ON/OFF shutter is controlled by a double-acting hydraulic cylinder that allows a quick interruption of the fertilizer flow. The delivery point and the fertilizer dose can be adjusted by means of two specific levers. The bottom of the hopper and all the adjustment parts are made of stainless steel to resist corrosion and ensure durability over time.

Double gate: ON/OFF and DOSE adjustment

Cold-forged element

Hydraulic cylinder to control the ON/OFF gate

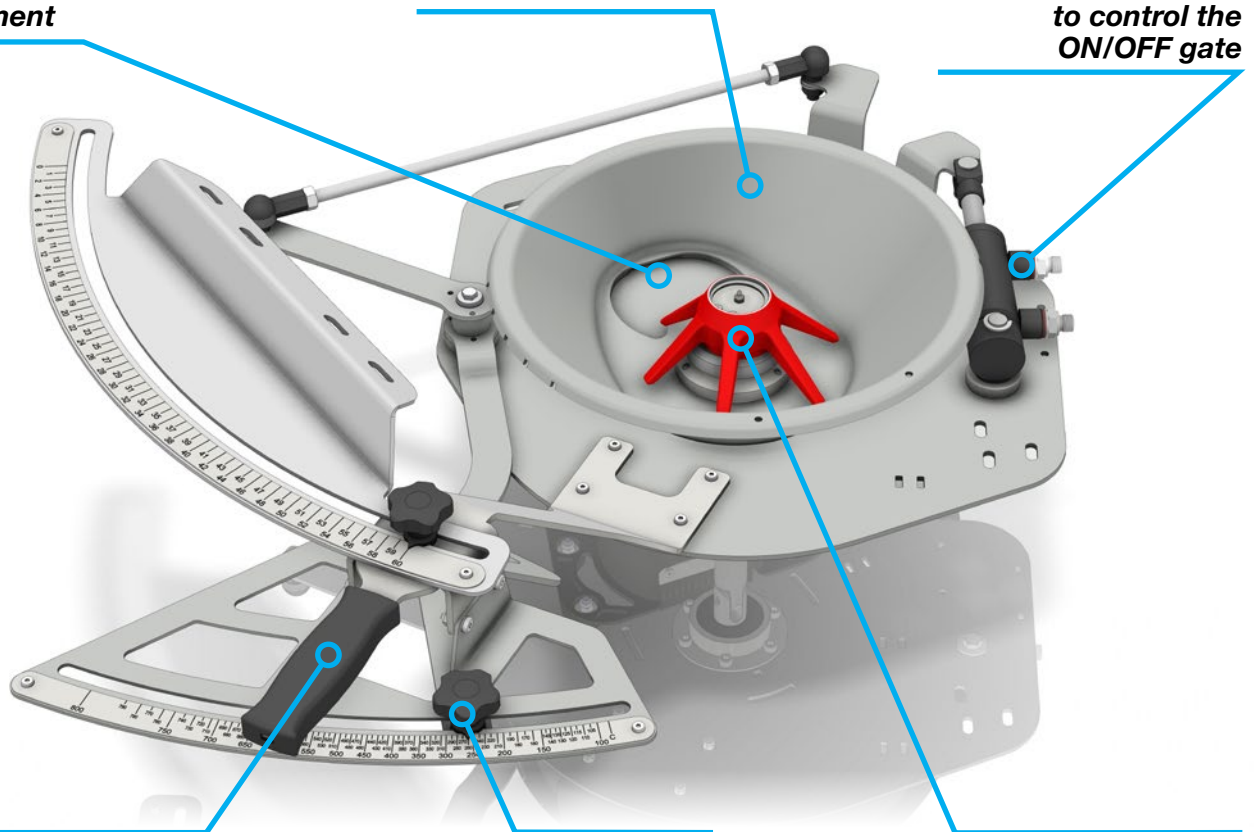

Delivery point adjustment

Fertilizer dose adjustment

Rotating head with roto-vibrating effect

Through the SPREADER SMART SET function, the MY MG APP allows you to obtain correct adjustments based on the distribution parameters entered.

PRIMO is the number one also in the distributable flow: up to 640 kg/min!

The special spreading system of the PRIMO range allows outgoing fertilizer flows up to 640 kg/min: top performance in the market.

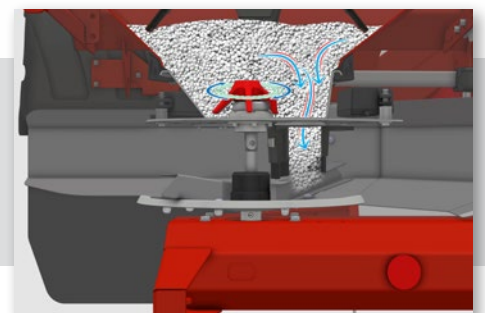

PRIMO E/EW

Continuous electronic distribution control

Electronics working for you

PRIMO E, with electronic management of the distribution proportional to the advancement (DPAE), allows the adjustment of the ON/OFF shutters and dose by means of electric actuators. The PRIMO EW model integrates continuous weighing to maximize performance and facilitate the use of the fertilizer spreader. All parameters and operating modes can be changed via the monitor provided.

Double gate: ON/OFF and DOSE adjustment

Electric actuator to control the dosing shutter

Cold-forged element

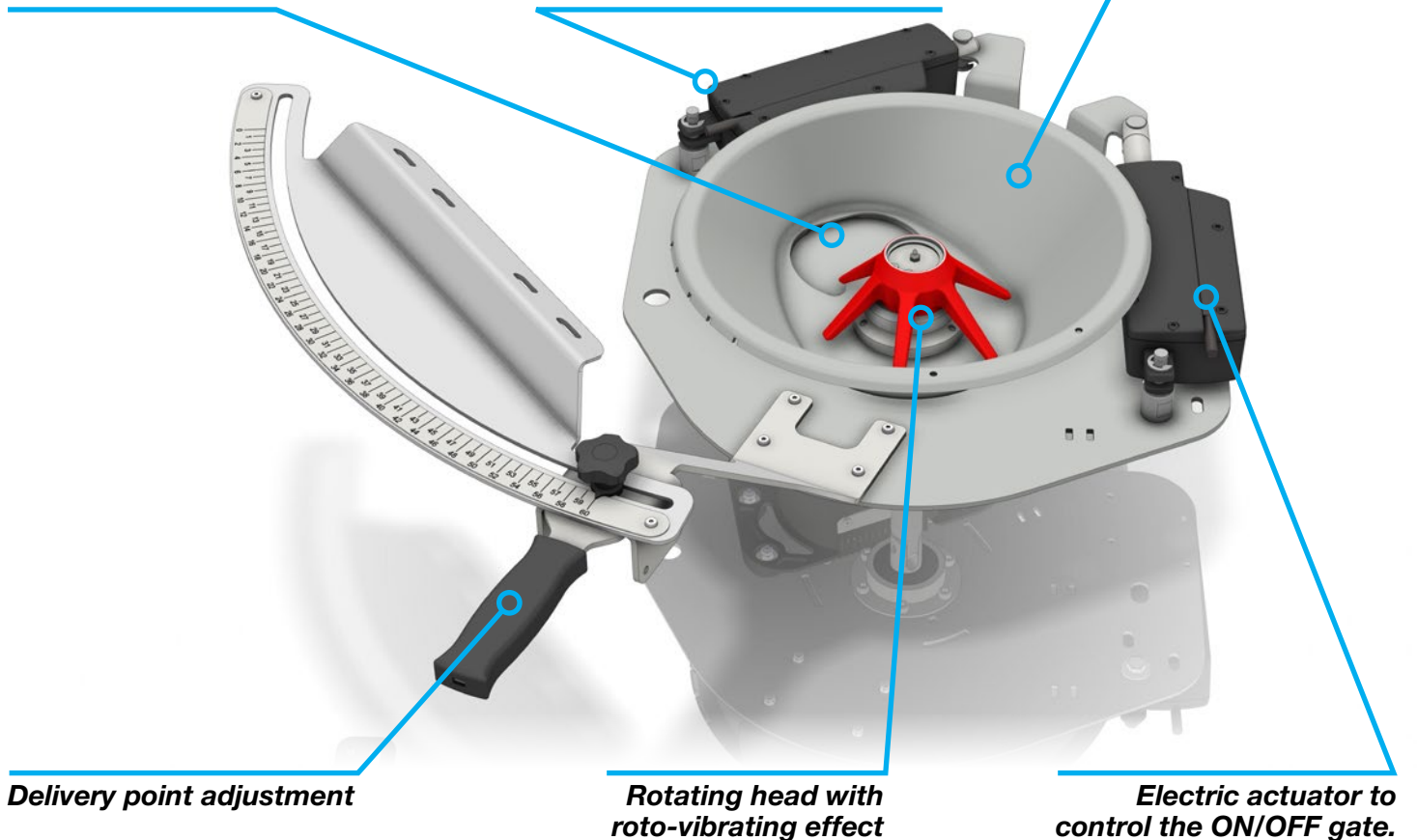

Double gate: ON/OFF and DOSE adjustment

The spreading system of the PRIMO range is characterized by the use of 2 shutters:

1) The ON/OFF shutter («A») is used to open and close the spreading system. Its rapid movement ensures the best responsiveness to the operator's commands.

2) The shutter that adjusts the DOSE («B») is used to control the fertilizer flow. Its position is directly linked to the speed of the tractor and the required dosage (automatic management with DPAE). This operation is maintained also during headland operations (shutter «A» closed). This ensures that when field spreading is resumed («A» open), shutter «B» will already be positioned correctly according to the speed of the tractor and the required dosage.



PRIMO E-EW ISOTRONIC



Continuous electronic distribution and weighing control

Fully automatic

PRIMO E-EW ISOTRONIC, with ISOBUS communication system with internally developed and AEF certified software, was developed for precision farming: management of variable dose (VR), of spreading sections (SC) and possibility of importing-exporting job data.

The ON/OFF adjustments and the dosage are controlled by electric actuators, to always guarantee maximum distribution precision. The delivery point control can be adjusted manually or automatically; the latter through an independent electric actuator (Section Control PRO).

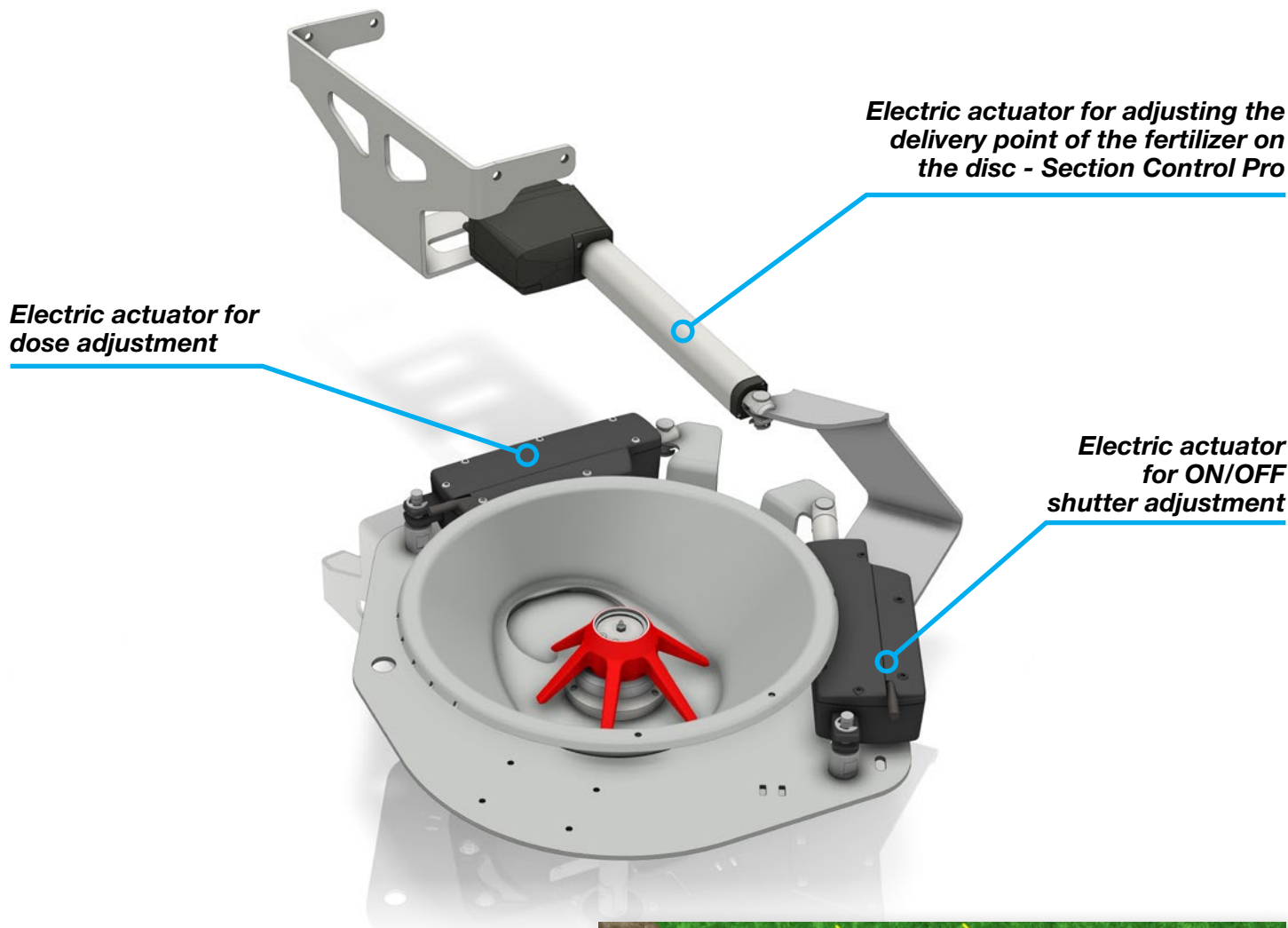

SECTION CONTROL PRO

For easy and fully electronic management, PRIMO E-EW ISOTRONIC can be set up with an automatically adjustable delivery point, controlled by an independent electric actuator on each side. This option is very useful when using the machine with section control: the combined automatic action of the dose and delivery point actuators ensures PRIMO E-EW ISOTRONIC has better accuracy in section spreading.

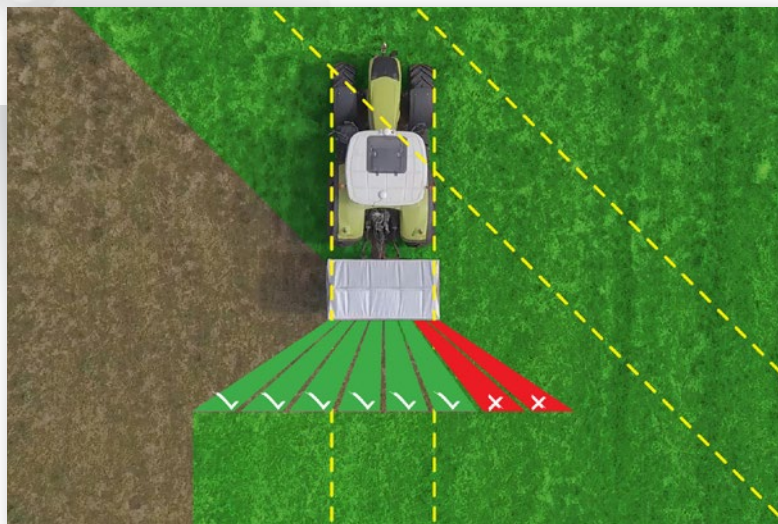

Precision farming

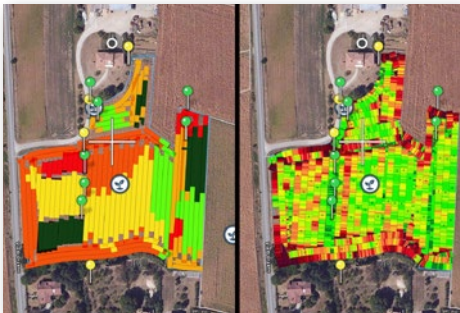
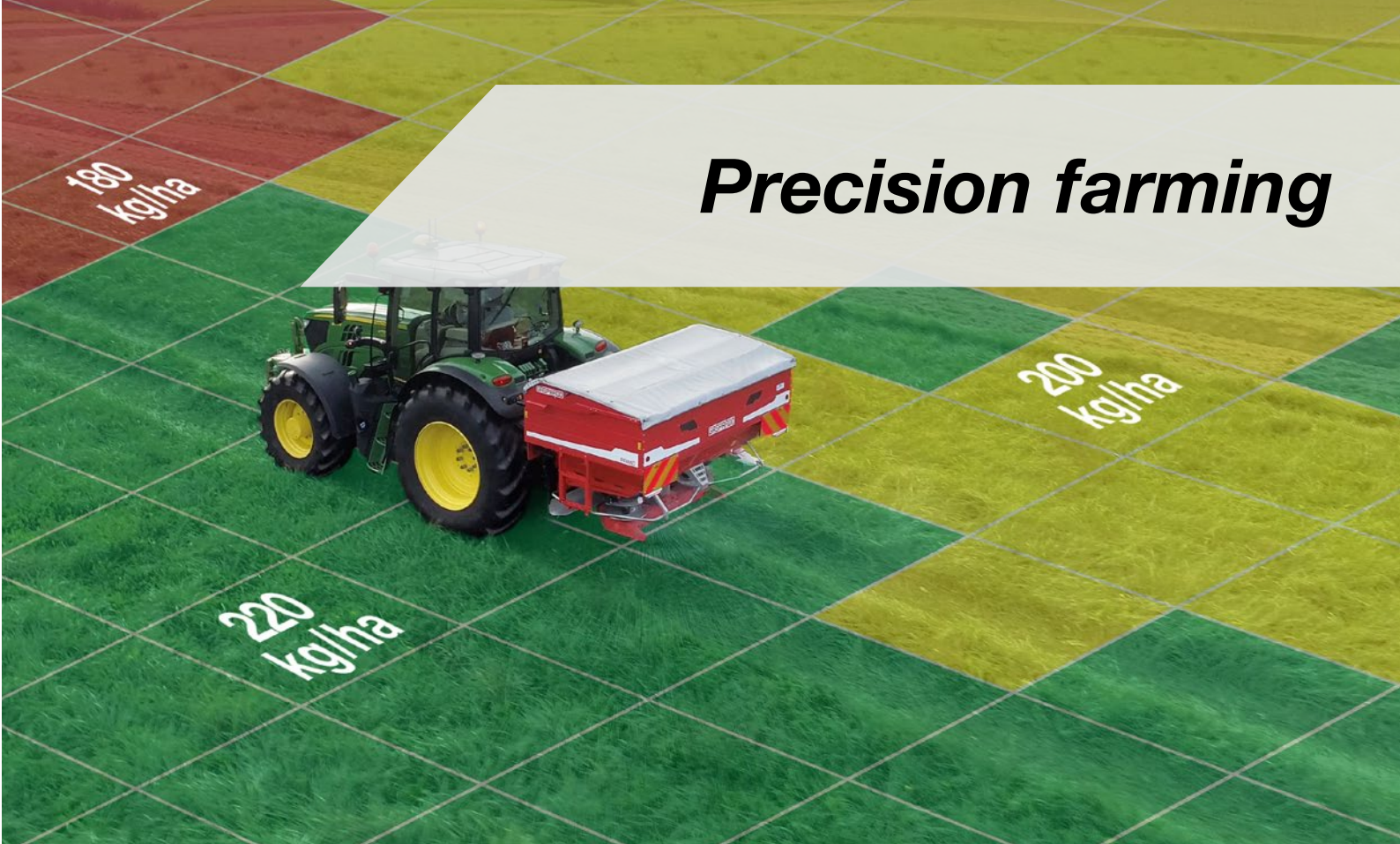

Precision farming

PRIMO E-EW ISOTRONIC fully applies the ISOBUS functionalities linked to Precision Farming, increasing crop productivity, reducing work time and facilitating successful farm management. Thanks to the section control and the variable dose, spreading is carried out homogeneously, without waste and damage to the crop, with consequent environmental and economic benefits. Each plant gets exactly the amount of treatment it needs.

Variable dose

With PRIMO E-EW ISOTRONIC it is possible to work on the basis of prescription maps that provide for a variable fertilizer dose according to the different production potential of often heterogeneous soils. This improves the efficiency in the use of fertilizer for the benefit of the crop and the environment, with a reduction in management costs.

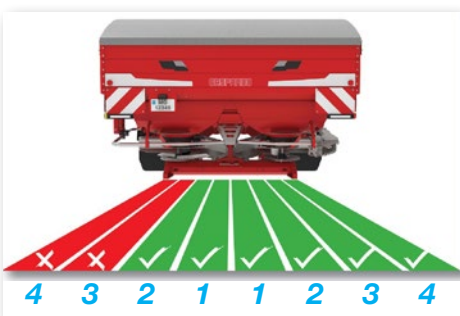

Section control

In an already fertilized area, the automatic closure of the sections allows no fertilization overlapping. The PRIMO fertilizer spreader maximizes fertilizer distribution efficiency thanks to the control of the 8 sections (4 right and 4 left), without waste or damage to the crop.

Designed to give the best



Sturdy and reliable

The structure of the frame and the load cell have been tested through dynamic field tests to ensure maximum reliability and resistance in any work situation.



Parallelogram double A-frame

The parallelogram double A-frame system facilitates the connection to the tractor and serves to mechanically transfer the weight from the hopper to the load cell without alterations. The goal is to correct the product flow thanks to more precise reading to reduce waste and the impact on the environment.

Every kilogram matters

In the PRIMO E-EW model, also available in the ISOTRONIC version, there is a load cell that allows the quantity of fertilizer present in the hopper to be read in real time. The on-board electronics calculate the amount of product distributed per unit of surface area and, if necessary, correct the flow to optimize the dose. The sensor used has been tested to withstand high stresses and maintain maximum accuracy over time.

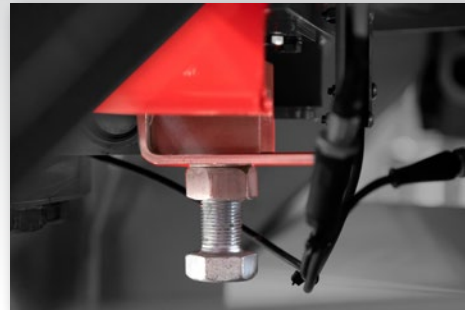

Straight to the goal

In the PRIMO EW ISO-TRONIC version, a special algorithm manages the weighing and corrects the opening of the dose shutters every 10 kg of distributed product: accuracy values unmatched in the market.

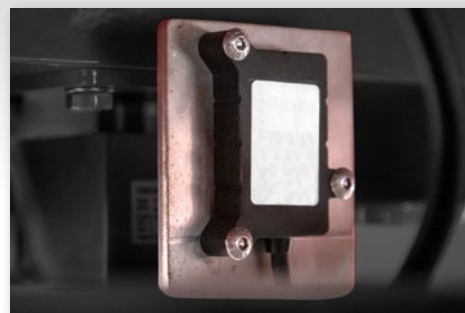

Easy adjustment via APP

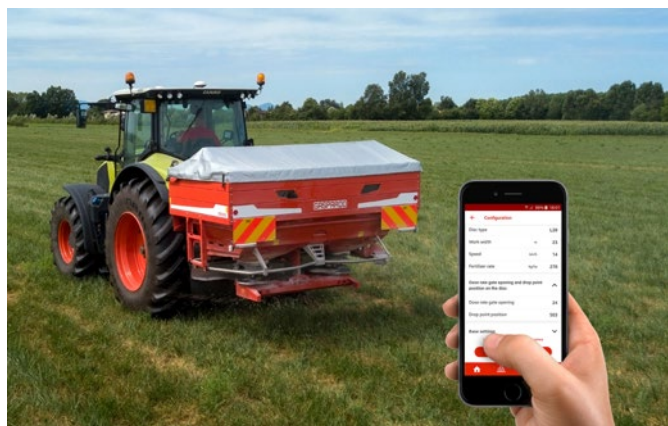

APP - MY MG

The MY MG APP allows you to effectively adjust all models in a few minutes, making field work easier and more precise. The **SPREADER SMART SET** function gives the operator all the PRIMO adjustments comfortably on his/her smartphone. It is sufficient to enter the parameters of the required spreading (type of fertilizer, working width and dose required) to obtain the correct settings for the fertilizer spreader and a quick summary of the used fertilizer specifications.

A FEW STEPS FOR A WINNING ADJUSTMENT

1 Enter the type of fertilizer, the disc and the working width.

2 Enter the forward speed and the dose kg/ha.

3 The values to adjust the shutter and the delivery point are displayed.

4 The values for adjusting the edge kit are displayed.

ONE RANGE, MANY POSSIBILITIES

	NOT ISOBUS			ISOBUS	
	PRIMO M	PRIMO E	PRIMO EW	PRIMO E ISOTRONIC	PRIMO EW ISOTRONIC
ON/OFF shutter adjustment	HYDRAULIC	ELECTRIC		ELECTRIC	
Dose adjustment	MANUAL	ELECTRIC		ELECTRIC	
Delivery point adjustment	MANUAL			ELECTRIC (optional)	
DPAE	-	●	●	●	●
Weighing cell	-	-	●	-	●
Tilt sensor	-	-	●	-	●
Variable dose (VR)	-	-	-	●	●
Section control (SC)	-	-	-	●	●

Management **TERMINALS**: everything under control

MONITORS FOR THE USE OF THE PRIMO E-EW ISOTRONIC IN PRECISION FARMING LOGIC



Tractor ISOBUS terminal

With an ISOBUS tractor, PRIMO ISOTRONIC allows extremely simple communication with the tractor terminal: a single connection cable allows the fertilizer spreader-tractor connection for the control and management of all the spreading functions.



TOUCH 800

The TOUCH 800 monitor is the solution for non-ISOBUS tractors that allows communication with the fertilizer spreader in a simple and functional way. Suitable for Precision Farming uses: Variable Dose (VR) and Spreading Section Control (SC).



BASIC TERMINAL

BASIC TERMINAL is easy to use and allows you to view and modify the spreading parameters. Only suitable for section control.



TERA 7

TERA 7 monitor is suitable for use with PRIMO for conventional management.

MONITORS FOR THE USE OF PRIMO E-EW

PRIMO E-EW is controlled by a terminal that offers various functions to better control the spreading of the fertilizer.

Its characteristics are:

- metered quantities as the tractor speed changes
- continuous calibration of the fertilizer flow
- speed sensor with GPS (**supplied as standard**)
- easy diagnosis of malfunctions in electric actuators
- work report
- software update via USB



Four working modes

- **Automatic:** once the desired quantity has been set, product distribution is continuously adjusted according to the detected speed. The electronic system periodically measures the weight in the hopper and performs a new calibration of the dose, always taking into consideration the type of fertilizer being used.
- **Semi-Automatic:** once the desired quantity has been set, the flow is automatically adjusted according to the speed. In the event of very rough terrain (e.g. after plowing), for a correct reading of the load cell, the flow rate is set when the machine is stopped every time the set calibration area is reached.
- **Speed:** the load cell information is disregarded and the distribution is controlled by the memorised distribution curve. This mode is used on terrains with steep slopes where the inclination can compromise the accuracy of the scale.
- **Manual:** the operator directly sets the distribution parameters, disabling the electronic controls fully.

ACCESSORIES



Hopper extension kit with or without inspection window



Cover sheet kit



Field edge gauge wheel kit



Mud flap kit (PRIMO M only)



Inspection ladder kit



Parking wheel kit



LED rear lights kit (standard on PRIMO EW - E/EW-ISOTRONIC)



Trolley for conversion into trailed



Virtual Terminal connection wiring



GPS antenna for speed detection



GPS antenna for position detection



Speed cable

PRIMO RANGE (M-E/EW-E/EW ISOTRONIC)	On-road width (cm)	Loading height (cm)	Working width (m)	Maximum capacity (kg)	Unladen mass PRIMO M (kg)	PRIMO E/EW- E/EW ISOTRONIC unladen mass (kg)
213	253	109	12-36	3200	439	519
218		124			471	551
224		139			503	583
229		154			535	615
314	285	109			448	528
320		124			482	562
326		139			516	586
332		154			570	650



GASPARDO

Growing Together

MASCHIO GASPARDO S.p.A.

Headquarters and production plant

Via Marcello, 73

I-35011 Campodarsego (PADUA) - Italy

Tel. +39 049 9289810 - Fax +39 049 9289900

info@maschiogaspardo.com - www.maschiogaspardo.com

Production plant

Via Mussons, 7

I-33075 Morsano al Tagliamento (PN) - Italy

Tel. +39 0434 695410 - Fax +39 0434 695425