

The background features a complex, abstract pattern of small, multi-colored dots (red, blue, green, yellow, white) arranged in a grid-like structure that recedes into the distance, creating a sense of depth and perspective. The dots are set against a dark blue background with some blurred, colorful light spots.

Energy Technology Perspectives 2023

iea

INTERNATIONAL ENERGY AGENCY

The IEA examines the full spectrum of energy issues including oil, gas and coal supply and demand, renewable energy technologies, electricity markets, energy efficiency, access to energy, demand side management and much more. Through its work, the IEA advocates policies that will enhance the reliability, affordability and sustainability of energy in its 31 member countries, 11 association countries and beyond.

This publication and any map included herein are without prejudice to the status of or sovereignty over any territory, to the delimitation of international frontiers and boundaries and to the name of any territory, city or area.

IEA member countries:

Australia
Austria
Belgium
Canada
Czech Republic
Denmark
Estonia
Finland
France
Germany
Greece
Hungary
Ireland
Italy
Japan
Korea
Lithuania
Luxembourg
Mexico
Netherlands
New Zealand
Norway
Poland
Portugal
Slovak Republic
Spain
Sweden
Switzerland
Republic of Türkiye
United Kingdom
United States

The European Commission also participates in the work of the IEA

IEA association countries:

Argentina
Brazil
China
Egypt
India
Indonesia
Morocco
Singapore
South Africa
Thailand
Ukraine

Abstract

The Covid-19 pandemic and Russia's invasion of Ukraine have led to major disruptions to global energy and technology supply chains. Soaring prices for energy and materials, and shortages of critical minerals, semiconductors and other components are posing potential roadblocks for the energy transition. Against this backdrop, the Energy Technology Perspectives 2023 (*ETP-2023*) provides analysis on the risks and opportunities surrounding the development and scale-up of clean energy and technology supply chains in the years ahead, viewed through the lenses of energy security, resilience and sustainability.

Building on the latest energy, commodity and technology data, as well as recent energy, climate and industrial policy announcements, *ETP-2023* explores critical questions around clean energy and technology supply chains: Where are the key bottlenecks to sustainably scale up those supply chains at the pace needed? How might governments shape their industrial policy in response to new energy security concerns for clean energy transitions? Which clean technology areas are at greatest risk of failing to develop secure and resilient supply chains? And what can governments do to mitigate such risks while meeting broader development goals?

The Energy Technology Perspectives series is the IEA's flagship technology publication, which has been key source of insights on all matters relating to energy technology since 2006. *ETP-2023* will be an indispensable guidebook for decision-makers in governments and industry seeking to tap into the opportunities offered by the emerging new energy economy, while navigating uncertainties and safeguarding energy security.

Foreword

The global energy sector is in the midst of profound changes that are set to transform it in the coming decades from one based overwhelmingly on fossil fuels to one increasingly dominated by renewables and other clean energy technologies. A new global energy economy is emerging ever more clearly, with the rapid growth of solar, wind, electric vehicles and a range of other technologies such as electrolysers for hydrogen. This transition is in turn changing the industries that supply the materials and products underpinning the energy system, heralding the dawn of a new industrial age – the age of clean energy technology manufacturing.

At the International Energy Agency (IEA), we are dedicated to improving the security, resilience and sustainability of the global energy system. Those interlinked priorities are at the heart of this edition of *Energy Technology Perspectives 2023 (ETP-2023)*, the latest in the IEA's technology flagship series that began in 2006. As decision-makers seek to understand and adapt to the changes underway, *ETP-2023* serves as the world's first comprehensive global guidebook on the clean energy technology industries of today and tomorrow. It provides a detailed analysis of clean energy technology manufacturing and its supply chains around the world – and how they are likely to evolve as the clean energy transition advances in the years ahead.

Major economies around the world – from Asia to Europe to North America – are stepping up efforts to expand their clean energy technology manufacturing with the overlapping aims of advancing net zero transitions, strengthening energy security and competing in the new energy economy. And the current global energy crisis has only accelerated these efforts.

These trends have massive implications for governments, businesses, investors and citizens around the world. Every country needs to identify how it can benefit from the opportunities and navigate the challenges of this new energy economy. This report shows that the rapid growth of clean technology manufacturing is set to create new markets worth hundreds of billions of dollars as well as millions of new jobs in the coming years, assuming countries make good on the energy and climate pledges they have announced.

At the same time, the industrial strategies that countries develop to secure their places in this new energy economy will need to take into account the emerging challenges that these changes bring. Today, we already see potentially risky levels of concentration in clean energy supply chains globally – both in the manufacturing of the technologies and in the critical minerals on which they rely.

These challenges are what make *ETP-2023* such a vital and timely contribution as policy makers are working to devise the industrial strategies to benefit their economies – and project developers and investors are weighing key decisions on future manufacturing operations. Our analysis shows that the global project pipeline is very large – enough to move the world much closer to reaching international energy and climate goals if it all comes to fruition. But the majority of those announced projects are not yet under construction or set to begin construction imminently. Governments have a role here in providing the supportive policies and broader industrial strategies that can provide developers and investors with the visibility and confidence they need to go ahead.

However, this report also shows issues of which governments need to be mindful, such as the importance of ensuring fair and open international trade in clean energy technologies, which will be essential for achieving rapid and affordable energy transitions. *ETP-2023* also makes clear that for most countries, it is not realistic to try to compete across all parts of clean energy technology supply chains. Countries will need to play to their strengths, whether that comes in the form of mineral resources, low-cost clean energy supplies, a workforce with relevant skills, or synergies with existing industries. And since no country will be in a position to cover every part of the supply chain at once, international collaboration will be an essential element in industrial strategies. This can include strategic partnerships and foreign direct investment, for example.

These are just some of the key issues on which *ETP-2023* provides extremely valuable insights. I'm confident decision-makers around the world will greatly appreciate these and the many others contained in these pages. And for this, I would like to thank the excellent team at the IEA's Energy Technology Policy Division, under the outstanding leadership of my colleague Timur Gül, for all the work that went into producing this report, which will serve as a reference for years to come.

Dr. Fatih Birol

Executive Director

International Energy Agency

Acknowledgements

This study was prepared by the Energy Technology Policy (ETP) Division of the Directorate of Sustainability, Technology and Outlooks (STO), with input from other divisions of the International Energy Agency (IEA). The study was designed and directed by **Timur Gül**, Head of the Energy Technology Policy Division.

The modelling and analytical teams of Energy Technology Perspectives 2023 (*ETP-2023*) were coordinated by **Araceli Fernandez** (Head of the Technology Innovation Unit) and **Uwe Remme** (Head of the Hydrogen and Alternative Fuels Unit). **Peter Levi** (industrial competitiveness) and **Leonardo Paoli** (investment needs) were responsible for the analysis of cross-cutting topics throughout the report.

The principal authors and contributors from the ETP division were (in alphabetical order):

Praveen Bains (synthetic hydrocarbon fuels), **Jose Miguel Bermudez** (hydrogen production including electrolyzers), **Amar Bhardwaj** (electrolyzers), **Sara Budinis** (direct air capture, technology manufacturing), **Elizabeth Connelly** (fuel cell trucks, technology manufacturing), **Chiara Delmastro** (heat pumps, technology manufacturing), **Mathilde Fajardy** (bioenergy with carbon capture, risk assessment), **Stavroula Evangelopoulou** (electricity infrastructure), **Breanna Gasson** (risk assessment), **Alexandre Gouy** (critical minerals, materials), **Carl Greenfield** (policy), **Will Hall** (sustainability, materials), **Mathilde Huismans** (wind, data management), **Megumi Kotani** (policy), **Jean-Baptiste Le Marois** (status of clean technology supply chains, innovation), **Rafael Martínez Gordón** (heat pumps, wind), **Shane McDonagh** (fuel cell trucks), **Rachael Moore** (CO₂ management infrastructure), **Faidon Papadimoulis** (trade, data management), **Francesco Pavan** (electrolyzers, hydrogen infrastructure), **Amalia Pizarro Alonso** (hydrogen infrastructure), **Richard Simon** (resilience, innovation), **Jacob Teter** (policy), **Tiffany Vass** (materials, policy) and **Biqing Yang** (China industrial policy).

The IEA's Energy Modelling Office led by Chief Energy Modeller Laura Cozzi coordinated the employment analysis, in particular Daniel Wetzels, Caleigh Andrews and Olivia Chen; and the analysis on electricity infrastructure, in particular Michael Drtil.

Other key contributors from across the IEA were Julien Armijo, Piotr Bojek, Leonardo Collina, Shobhan Dhir, Conor Gask, Pablo Gonzalez, Ilkka Hannula,

George Kamiya, Samantha McCulloch, Yannick Monschauer, Takashi Nomura, Nasim Pour, Vida Rozite and Fabian Voswinkel.

Valuable comments and feedback were provided by other senior management and numerous other colleagues within the IEA, in particular Keisuke Sadamori, Laura Cozzi, Dan Dorner, Tim Gould, Brian Motherway, Paolo Frankl, Heymi Bahar, Simon Bennett, Thomas Spencer and Brent Wanner.

Caroline Abettan, Liselott Fredriksson, Reka Koczka and Per-Anders Widell provided essential support throughout the process.

Thanks also to the IEA Communications and Digital Office for their help in producing the report, particularly to Jad Mouawad, Curtis Brainard, Jon Custer, Hortense De Roffignac, Tanya Dyhin, Merve Erdem, Grace Gordon, Barbara Moure, Jethro Mullen, Isabelle Nonain-Semelin, Julie Puech, Clara Vallois, Gregory Viscusi, Therese Walsh and Wonjik Yang. Trevor Morgan provided writing support to the report and holds editorial responsibility. Erin Crum and Kristine Douaud were the copy-editors.

The work could not have been achieved without the financial support provided by the Governments of Australia and Japan.

Several senior government official and experts provided essential input and feedback to improve the quality of the report. They include:

Matt Antes	Department of Energy, United States
Florian Ausfelder	DECHEMA
Matthew Aylott	Department for Business, Energy and Industrial Strategy, United Kingdom
Harmeet Bawa	Hitachi Energy
Adam Baylin-Stern	Carbon Engineering
Marlen Bertram	International Aluminium Institute
Fabrizio Bezzo	Università di Padova
Souvik Bhattacharjya	TERI, the Energy and Resources Institute, India
Chris Bolesta	Directorate-General for Energy, European Commission
Javier Bonaplata	ArcelorMittal
Antoine Boubault	Bureau de Recherches Géologiques et Minières, France
Keith Burnard	Technology Collaboration Programme on Greenhouse Gas R&D
Wang Can	Tsinghua University
Diego Carvajal	European Copper Alliance
Roland Chavasse	International Lithium Association
Xavier Chen	Beijing Energy Club
Jianhong Cheng	China National Institute of Standardization

Beatrice Coda	CINEA, the European Climate, Infrastructure and Environment Executive Agency, European Commission
Russell Conklin	Department of Energy, United States
Jasmin Cooper	Imperial College London
James Craig	Technology Collaboration Programme on Greenhouse Gas R&D
Colin Cunliff	Department of Energy, United States
Ilka von Dalwigk	EIT InnoEnergy
Ganesh Das	Tata Power
Charis Demoulias	Aristotle University of Thessaloniki
Alberto DiLullo	Eni
Tim Dixon	Technology Collaboration Programme on Greenhouse Gas R&D
Sayanta Dutta	Hyzon Motors
Åsa Ekdahl	World Steel Association
Sara Evangelisti	Gas and Heat SpA
Pharoah Le Feuvre	Enagas
Alan Finkel	Government of Australia
Fridtjof Fossum Unander	Aker Horizons
Hiroyuki Fukui	Toyota
Jan Fredrik Garvik	Hydrogen Pro
Sara Giarola	Politecnico di Milano
James Glynn	Columbia University
Stefan Gossens	Schaeffler AG
Astha Gupta	Independent consultant
Emmanuel Hache	IFP Energies nouvelles
Martin Haigh	Shell
Chen Haisheng	China Energy Storage Alliance
Neville Hargreaves	Velocys
Clare Harris	Shell
Yuya Hasegawa	Ministry of Economy, Trade and Industry, Japan
Nikolaos Hatzigiorgiou	National Technical University of Athens
Roland Hequet	John Cockerill
Vincent D'Herbemont	IFP Energies nouvelles
Chris Heron	Eurometaux
Ludo van Hijfte	Carbon Collectors
Neil Hirst	Imperial College London
Geoff Holmes	Carbon Engineering
Noé van Hulst	International Partnership for Hydrogen and Fuel Cells in the Economy
Marie Ishikawa	Toyota
Rishabh Jain	Council on Energy, Environment and Water, India
Ayaka Jones	Department of Energy, United States
Birte Holst Jørgensen	Technical University of Denmark
Robert Kennedy Smith	Department of Energy, United States

Balachander Krishnan	Shirdi Sai Electricals Ltd
Leif Christian Kröger	Thyssenkrupp Nucera
Oji Kuno	Toyota
Oleksandr Laktionov	Naftogaz
Martin Lambert	Oxford Institute for Energy Studies
Francisco Laverón	Iberdrola
Xiao Lin	Technology Collaboration Programme on Hybrid and Electric Vehicles
Sebastian Ljungwaldh	Northvolt
Claude Lorea	Global Cement and Concrete Association
Patricia Loria	Carbon Capture Inc.
Giuseppe Lorubio	Ariston
Richard Lowes	Regulatory Assistance Project
Louis Marie Malbec	IFP Energies nouvelles
Foivos Marias	CINEA, the European Climate, Infrastructure and Environment Executive Agency, European Commission
Mercedes Maroto-Valer	Heriot-Watt University
Rick Mason	Plug Power
Marc Melaina	Department of Energy, United States
Dennis Mesina	Department of Energy, United States
Roberto Millini	Eni
Diane Millis	Carbon Clean
Vincent Minier	Schneider Electric
Mark Mistry	Nickel Institute
Daniel Monfort	Bureau de Recherches Géologiques et Minières, France
Victoria Monsma	DNV
Nirvasen Moonsamy	Oil and Gas Climate Initiative
Simone Mori	Enel
Hidenori Moriya	Toyota
Poul Georg Moses	Topsoe
Ramin Moslemian	DNV
Vivek Murthi	Nikola
Jane Nakano	Center for Strategic and International Studies
Hidetaka Nishi	Ministry of Economy, Trade and Industry, Japan
Motohiko Nishimura	Kawasaki Heavy Industries
Takashi Nomura	Toyota
Olga Noskova	Topsoe
Thomas Nowak	European Heat Pump Association
Koichi Numata	Toyota
Shaun Onorato	United States National Renewable Energy Laboratory
Stavros Papathanasiou	National Technical University of Athens
Claudia Pavarini	Snam
Inga Petersen	Global Battery Alliance

Cédric Philibert	IFRI, l'Institut français des relations internationales
Larry Pitts	Plug Power
Joana Portugal	Université Fédérale de Rio de Janeiro
Andrew Purvis	World Steel Association
Aditya Ramji	University of California, Davis
Julia Reinaud	Breakthrough Energy
Stephan Renz	Technology Collaboration Programme on Heat Pumping Technologies
Mark Richards	Rio Tinto
Grégoire Rigout	Air Liquide
Pablo Riesgo Abeledo	Directorate-General for Energy, European Commission
Agustín Rodríguez Riccio	Topsoe
Antonio Ruiz	Nikola
Toshiyuki Sakamoto	Institute of Energy Economics, Japan
Gerhard Salge	Hitachi Energy
María Sicilia Salvadores	Enagas
Bariş Sanli	Permanent Delegation of Türkiye to the OECD
Abhishek Saxena	NITI Aayog, National Institution for Transforming India
Hannah Schindler	Federal Ministry for Economic Affairs and Climate Action, Germany
Olaf Schilgen	Volkswagen
Thore Sekkenes	EIT InnoEnergy
Cory Shumaker	Hyzon Motors
Jim Skea	Imperial College London
Guillaume de Smedt	Air Liquide
Robert Spicer	BP
Vivek Srinivasan	Commonwealth Scientific and Industrial Research Organisation, Australia
Martin Stuermer	International Monetary Fund
Bert Stuij	Netherlands Enterprise Agency
Peter Taylor	University of Leeds
Wim Thomas	Independent consultant
Dietmar Tourbier	Commonwealth Scientific and Industrial Research Organisation, Australia
Lyle Trytten	Independent consultant
Yusuke Tsukahara	Asahi Kasei
Inés Tunga	Energy Systems Catapult
Cornelius Veith	Federal Ministry for Economic Affairs and Climate Action, Germany
Rahul Walawalkar	India Energy Storage Alliance
Michael Wang	Argonne National Laboratory
Amanda Wilson	Natural Resources Canada
Markus Wråke	Swedish Energy Research Centre
Akira Yabumoto	J-Power

Makoto Yasui
Nozomi Yokoo
Shiho Yoshizawa
Alan Zhao

Chiyoda
Toyota
Ministry of Economy, Trade and Industry, Japan
Cummins

Table of contents

Executive summary	20
Introduction	26
Purpose of this report.....	26
Clean energy and technology supply chains	27
Scope and analytical approach.....	29
Report structure	34
References	35
Chapter 1. Energy supply chains in transition	36
Highlights.....	36
The clean energy transition.....	37
Implications of net zero for supply chains.....	50
References	75
Chapter 2. Mapping out clean energy supply chains	81
Highlights.....	81
Assessing vulnerabilities in supply chains	82
Geographic diversity and energy security	85
Resilience of supply chains.....	115
Supply chain sustainability.....	128
References	135
Chapter 3. Mining and material production	142
Highlights.....	142
Material needs for net zero emissions	143
Mineral extraction.....	156
Materials production.....	169
References	199
Chapter 4. Technology manufacturing and installation	206
Highlights.....	206
Overview	207
Mass manufacturing of clean technologies and components	212
Installation of large-scale, site-tailored technologies.....	248
References	267
Chapter 5. Enabling infrastructure	276
Highlights.....	276
The role of enabling infrastructure	277

Electricity grids	279
Hydrogen transport and storage	300
CO ₂ management infrastructure	330
Focus on repurposing existing infrastructure.....	343
References	349
Chapter 6. Policy priorities to address supply chain risks	356
Highlights.....	356
Designing policies for supply chains.....	357
Prioritising policy action	364
References	431
Annex.....	439
Glossary	439
Clean supply chain characteristics	444
Regional definitions.....	453
Acronyms and abbreviations.....	454
Units of measure	455
Currency conversions	456
References	457

List of figures

Figure I.1	Steps and interdependencies of technology and energy supply chains	28
Figure I.2	Key elements for each step in selected clean energy and technology supply chains	31
Figure 1.1	Global mass-based resource flows into the energy system, 2021.....	39
Figure 1.2	Global total primary energy supply in the NZE Scenario	41
Figure 1.3	Global energy flows in the NZE Scenario	43
Figure 1.4	Total primary energy supply, electrification rates and energy intensity in 2030 in the APS and NZE Scenario	44
Figure 1.5	Global cumulative energy sector CO ₂ emissions reductions by decarbonisation pillar and clean energy and technology supply chains studied in <i>ETP-2023, 2021-2050</i>	45
Figure 1.6	Global deployment of selected clean energy technologies in the NZE Scenario	47
Figure 1.7	Heat pumps and heating distribution system market price and installation time for a typical household by type of equipment, 2021	48
Figure 1.8	Time frame for prototype to market introduction and early adoption for selected clean energy technologies in the past and the NZE Scenario	49
Figure 1.9	Global average raw material requirements for selected energy technologies, 2021	52
Figure 1.10	Global supply gap with the NZE Scenario and geographic concentration by stage and technology based on expansion announcements, 2030	55
Figure 1.11	Global investment in selected clean energy supply chains needed to bring online enough capacity in 2030 in the NZE Scenario, by supply chain step	56
Figure 1.12	Cost of capital for bulk material production industries by country/regional grouping, 2020	57

Figure 1.13	Indicative levelised cost of production for selected bulk materials.....	59
Figure 1.14	Increase in the global average prices of selected clean energy products from switching to low-emission bulk material production	60
Figure 1.15	Lead times for mining of selected minerals.....	61
Figure 1.16	Range of (top) and average (bottom) global lead times for selected clean energy technology supply chains	64
Figure 1.17	Global scaling-up of selected energy and other supply chains by lead time in the past (solid) and the NZE Scenario (dashed).....	66
Figure 1.18	Typical operating lifetime of selected energy technologies.....	67
Figure 1.19	Global energy sector employment by technology	68
Figure 1.20	Energy employment by region and supply chain step, 2019	69
Figure 1.21	Energy employment in selected sectors by region, 2019	70
Figure 1.22	Global energy sector employment by technology in the NZE Scenario.....	72
Figure 1.23	Global employment by skill level, 2019	73
Figure 2.1	Interconnections between selected energy and technology supply chains	84
Figure 2.2	Regional shares of global fossil fuel and uranium production and resources, 2021.....	85
Figure 2.3	Global reserves and extraction of selected resources by region, 2021	86
Figure 2.4	Regional shares of global production of selected critical materials, 2021	89
Figure 2.5	Estimated end-use shares of global consumption of selected bulk materials, 2021.....	90
Figure 2.6	Regional shares in global production of bulk materials and intermediate commodities, 2021	91
Figure 2.7	Regional shares of manufacturing capacity for selected mass-manufactured clean energy technologies and components, 2021.....	95
Figure 2.8	Regional shares in global installed operating capacity of selected large-scale site-tailored clean energy technologies, 2021	101
Figure 2.9	Share of inter-regional trade in global production for selected minerals, materials and technologies, 2021	105
Figure 2.10	Trade balance along supply chains in selected countries/regions, 2021.....	106
Figure 2.11	Global trade flows of lithium-ion batteries and electric vehicles, 2021	108
Figure 2.12	EV imports to Europe by country of production and manufacturer, 2021	109
Figure 2.13	Global trade flows along the solar PV supply chain, 2021.....	111
Figure 2.14	Global trade flows of wind energy components in USD, 2021.....	112
Figure 2.15	Global inter-regional trade flows of heat pumps, 2021	113
Figure 2.16	Heat pump manufacturing capacity by company headquarters and plant location, and installations by region/country, 2021	115
Figure 2.17	International prices of selected critical and bulk materials and energy.....	116
Figure 2.18	Energy intensity of extracting and producing selected critical and bulk materials, and of manufacturing selected energy technologies, 2021.....	118
Figure 2.19	Average manufacturing cost breakdown of selected energy technologies and components by commodity, 2019-2021	119
Figure 2.20	Average ammonia production costs by technology and component in selected regions/countries, 2022.....	121
Figure 2.21	Return on assets of companies in selected upstream, bulk materials and manufacturing sectors	123
Figure 2.22	Global inventories as a share of annual consumption for selected bulk materials, minerals and fuels	124
Figure 2.23	Semiconductor manufacturing capacity and market share revenue, 2021	127
Figure 2.24	Supply chain step shares in total CO ₂ emissions from the production of solar PV, wind turbines, EVs and heat pumps, 2021.....	129
Figure 2.25	Global average life-cycle greenhouse gas emissions intensity of selected energy technologies, 2021	130

Figure 2.26	Global average primary energy and CO ₂ emissions intensity of mining and processing of selected critical and bulk materials, 2021	131
Figure 3.1	Global mass-based resource flows into the energy system in the NZE Scenario, 2050	144
Figure 3.2	Total global material demand by type in the NZE Scenario	147
Figure 3.3	Global critical material demand by end use in the NZE Scenario	149
Figure 3.4	Estimated global bulk material demand by end use in the NZE Scenario	150
Figure 3.5	Share of secondary production in the global supply of selected materials in the NZE Scenario	154
Figure 3.6	Change in global demand for selected minerals in the NZE Scenario, 2021-2030	157
Figure 3.7	Primary production of selected minerals by country/region in the NZE Scenario and based on currently anticipated supply	159
Figure 3.8	Anticipated investment in mining of critical minerals by region/country and that required to meet mineral demand over 2022-2030 in the NZE Scenario	161
Figure 3.9	Shares of the leading regions in global mining of selected critical minerals in 2021 and 2030 based on currently anticipated investments	163
Figure 3.10	Global energy intensity and average grade of ore production for selected metals	166
Figure 3.11	Theoretical global energy consumption and CO ₂ emissions in mining of selected minerals for meeting NZE Scenario demand levels at current carbon intensity	167
Figure 3.12	Decomposition of change in global direct CO ₂ emissions from mining of selected minerals between 2021 and 2050 in the NZE Scenario	169
Figure 3.13	Production of selected critical materials by country/region in the NZE Scenario and based on currently anticipated supply	171
Figure 3.14	Anticipated investment in critical material production by region/country and that required to meet demand over 2022-2030 in the NZE Scenario	172
Figure 3.15	Shares of the leading regions in global processing of selected critical minerals in 2021 and 2030 based on currently anticipated investments	173
Figure 3.16	Emissions intensity of different lithium hydroxide production routes by fuel used and process temperature, 2021	176
Figure 3.17	Production of bulk materials by country/region and type of technology in the NZE Scenario	179
Figure 3.18	Estimates of near zero emission material production based on project announcements and the NZE Scenario in 2030	182
Figure 3.19	Shares of the leading regions in global production of selected bulk materials in 2021 and 2030 in the NZE Scenario	184
Figure 4.1	Current global manufacturing capacity, announced capacity additions, capacity shortfall in 2030 relative to the NZE Scenario, and lead times for selected mass-manufactured clean energy technologies and components	208
Figure 4.2	Current global capacity, announced capacity additions, capacity shortfall in 2030 relative to the NZE Scenario, and installation lead times for selected large-scale, site-tailored clean energy technologies	209
Figure 4.3	Global employment in manufacturing and installing selected mass-manufactured clean energy technologies in the NZE Scenario, 2019 and 2030	210
Figure 4.4	Announced global cumulative investment in mass manufacturing of selected clean energy technologies by region/country and that required to meet demand in 2030 in the NZE Scenario, 2022-2030	214
Figure 4.5	Solar PV manufacturing capacity by country/region according to announced projects and in the NZE Scenario	216
Figure 4.6	Wind power manufacturing capacity by component and country/region according to announced projects and in the NZE Scenario	220
Figure 4.7	Financial indicators for non-Chinese wind turbine manufacturers	222

Figure 4.8	Battery and component manufacturing capacity by country/region according to announced projects and in the NZE Scenario	225
Figure 4.9	Heavy-duty fuel cell truck and mobile fuel cell manufacturing capacity by country/region according to announced projects and in the NZE Scenario	229
Figure 4.10	Heat pump manufacturing capacity by country/region according to announced projects and in the NZE Scenario	235
Figure 4.11	Global annual sales of heat pump technologies for buildings in the NZE Scenario	240
Figure 4.12	Electrolyser manufacturing capacity by country/region according to announced projects and in the NZE Scenario	242
Figure 4.13	Announced global cumulative investment in large-scale, site-tailored clean energy technologies by region/country and that required to meet demand in 2030 in the NZE Scenario, 2022-2030	250
Figure 4.14	Capacity of hydrogen production from natural gas with CCS by country/region according to announced projects and in the NZE Scenario	252
Figure 4.15	Direct air capture capacity by country/region for use and storage according to announced projects and in the NZE Scenario	256
Figure 4.16	Capacity of bioenergy with CO ₂ captured for use and storage by country/region according to announced projects and in the NZE Scenario	259
Figure 4.17	Low-emission synthetic hydrocarbon fuel production capacity by country/region according to announced projects and in the NZE Scenario	262
Figure 5.1	Global historic deployment and investments in electricity and natural gas infrastructure	277
Figure 5.2	Key technology components of electricity grids	280
Figure 5.3	Global high-voltage direct current (HVDC) transmission lines by country/region and line type	281
Figure 5.4	Gross electricity grid additions in advanced and emerging economies in the NZE Scenario	284
Figure 5.5	Average annual transformer and stationary-battery capacity additions in the NZE Scenario	285
Figure 5.6	Average annual material needs for selected grid technologies in the NZE Scenario	287
Figure 5.7	Typical material composition of overhead lines and cables by weight, 2021	288
Figure 5.8	Typical material composition of transformers and stationary batteries by weight and value, 2021	289
Figure 5.9	Global trade flows of grain-oriented steel by weight, 2020	293
Figure 5.10	Global trade flows of transformers above 10 MW in monetary terms, 2020	294
Figure 5.11	Average lead times to build new electricity grid assets in Europe and the United States, 2010-2021	296
Figure 5.12	Hydrogen pipeline network configuration	301
Figure 5.13	Technological pathways for long-distance transport for the supply of hydrogen and ammonia by tanker	302
Figure 5.14	Global natural gas and hydrogen supplies in the NZE Scenario	304
Figure 5.15	Average annual global investment in hydrogen and natural gas infrastructure in the NZE Scenario	304
Figure 5.16	Global hydrogen transmission pipeline length in the NZE Scenario	305
Figure 5.17	Global production of low-emission merchant hydrogen and interregional trade in the NZE Scenario	308
Figure 5.18	Interregional trade and infrastructure for shipping low-emission hydrogen in the NZE Scenario compared with historical LNG trade	309
Figure 5.19	Tanker capacity in energy and volume terms by energy carrier type in the NZE Scenario, 2030	309
Figure 5.20	Global LNG trade and largest LNG and LH ₂ tanker sizes	312
Figure 5.21	International ammonia trade flows via shipping, 2019	313

Figure 5.22	Indicative levelised cost of delivering hydrogen, by transport option and distance in the NZE Scenario, 2030.....	315
Figure 5.23	Indicative levelised cost of delivering hydrogen, by shipping-option step and distance in the NZE Scenario, 2030.....	316
Figure 5.24	Global underground geological storage capacity for hydrogen in the NZE Scenario and historical growth in natural gas storage by region	318
Figure 5.25	Global liquefied gas tanker deliveries by country and type in the NZE Scenario	323
Figure 5.26	Lead times of selected natural gas infrastructure projects.....	326
Figure 5.27	Global energy consumption for hydrogen transportation in the NZE Scenario.....	328
Figure 5.28	Energy consumption and overall efficiency of hydrogen transport and distance in the NZE Scenario, 2030	329
Figure 5.29	CO ₂ flows through the CO ₂ management value chain	331
Figure 5.30	CO ₂ pipeline network.....	332
Figure 5.31	Criteria for CO ₂ source-sink matching.....	335
Figure 5.32	Indicative CO ₂ shipping and offshore pipeline transportation costs.....	338
Figure 5.33	Existing and planned annual global CO ₂ storage injection capacity, compared with projected NZE Scenario needs in 2030	339
Figure 5.34	Lead times for the CO ₂ storage component of selected CCUS projects with dedicated storage.....	341
Figure 5.35	Lead times of selected recent natural gas and CO ₂ pipeline projects	342
Figure 6.1	Risks threatening acceleration of the global clean energy transition.....	366
Figure 6.2	Annual energy sector investments by regional grouping in the NZE Scenario.....	370
Figure 6.3	Public energy R&D by region and corporate energy R&D by technology.....	373
Figure 6.4	Risks to the energy security of global clean energy supply chains.....	386
Figure 6.5	Geographic concentration for key critical minerals, material production and manufacturing operations for clean energy technologies	388
Figure 6.6	Announced project throughput and deployment for key clean energy technologies in the APS and the NZE Scenario	389
Figure 6.7	Market size for key clean energy technologies and net fossil fuel trade in the APS	391
Figure 6.8	Employment in clean energy technology manufacturing by region	393
Figure 6.9	Concentrations of the largest enterprises in global manufacturing capacity and material production, 2021	395
Figure 6.10	Risk to resilience of global selected clean energy and technology supply chains.....	404
Figure 6.11	Industry end-user prices for natural gas and electricity in selected countries	406
Figure 6.12	Indicative production costs for hydrogen and hydrogen-based commodities produced via electrolysis.....	408
Figure 6.13	Global cathode production for passenger light-duty BEVs by chemistry in the NZE Scenario	410
Figure 6.14	Risk of failing to reduce CO ₂ emissions in the most intensive steps of selected clean energy and technology supply chains.....	416
Figure 6.15	Number of companies committed to purchasing low-emission steel by end-use sector, and global market size for selected bulk materials in the NZE Scenario ...	419

List of boxes

Box 2.1	Clean energy supply chains interdependencies	84
Box 2.2	The different steps of metal production.....	87
Box 2.3	Resilience and vulnerabilities in the ammonia supply chain.....	120
Box 2.4	Stockpiles of critical minerals and energy security	123

Box 2.5	The chip shortage is holding back the deployment of EVs	126
Box 2.6	Mining waste stored behind tailings dams	133
Box 3.1	Clarifying materials-related terminology	144
Box 3.2	Behavioural change to reduce the supply chain challenge	152
Box 3.3	Increasing recyclability of clean energy technologies	155
Box 3.4	Plans for near zero emission material production	180
Box 4.1	Potential installation bottlenecks in the wind sector	211
Box 4.2	Carbon intensity of technology manufacturing	214
Box 4.3	The heat pump market: Synergies between end uses and subsectors	240
Box 4.4	Strategies to decarbonise road transport: Potential role for low-emission synthetic hydrocarbon fuels	264
Box 5.1	Why do energy infrastructure projects take so long?	296
Box 5.2	Environmental impacts of liquefied gas shipping	330
Box 6.1	Case study: The solar PV supply chain in China	361
Box 6.2	Case study: Strategic partnerships in clean energy supply chains	363
Box 6.3	Case study: Policy responses to the semiconductor shortage	367
Box 6.4	Case study: Strategies for clean energy supply chains in the United States and Europe	374
Box 6.5	Case study: Identifying strategic projects in the European Union	376
Box 6.6	Case study: A one-stop shop for EV charging support in the United States	378
Box 6.7	Case study: Enhancing transferable skills in Alberta	380
Box 6.8	Case study: Financing innovation in the European Union	383
Box 6.9	Case studies: Support for new mines and manufacturing plants	401
Box 6.10	Case study: EU right-to-repair rules	412
Box 6.11	Case study: Repurposing fossil energy infrastructure in the United Kingdom and United States	414
Box 6.12	Case study: Standards for concrete and asphalt in the United States	420
Box 6.13	Lifecycle-based low-carbon fuel standards	421
Box 6.14	Case study: Incentivising the circular economy of battery supply chains in the European Union	423
Box 6.15	Case study: Supporting sustainable battery value chains by 2030 and the battery passport	425
Box 6.16	Case study: The shifting focus of EU climate policy on supply chains	428
Box 6.17	Case study: Incentivising clean construction materials in the United States	430

List of tables

Table 2.1	Characteristics of secure, resilient and sustainable clean energy technology supply chains	83
Table 2.2	Examples of digital technology use across clean energy supply chains	125
Table 2.3	Use of semiconductors in clean energy technologies	126
Table 2.4	Environmental impact of mining for selected minerals	133
Table 3.1	Leading minerals and materials for clean energy supply chains by type	145
Table 3.2	Examples of government supply-side support for low-emission material production	185
Table 3.3	Examples of government demand-side policies for low-emission material production and private- and public-sector commitments	186
Table 3.4	Top steel producers and leading existing or planned projects making progress towards near zero emission steel production	188
Table 3.5	Top cement producers and leading existing or planned projects making progress towards near zero emission cement production	192

Table 3.6	Top plastics producers and leading existing or planned projects making progress towards near zero emission plastics production	195
Table 3.7	Top aluminium producers and leading existing or planned projects making progress towards near zero emission aluminium production	197
Table 4.1	Selected announced expansion projects for manufacturing solar PV supply chain components	217
Table 4.2	Announced expansion projects of selected battery makers and automakers.....	226
Table 4.3	Expansion plans of selected heavy-duty fuel cell truck and fuel cell manufacturers	230
Table 4.4	Announced heat pump manufacturer expansion projects by country and type of investment	237
Table 4.5	Announced expansion plans of key electrolyser manufacturers.....	244
Table 4.6	Planned capacity expansions of selected companies to produce hydrogen from natural gas with CCS.....	252
Table 4.7	Direct air capture expansion projects of selected companies.....	257
Table 4.8	Announced BECC expansion projects of selected companies.....	260
Table 4.9	Announced low-emission synthetic hydrocarbon fuel capacity by company	263
Table 5.1	Global grain-oriented steel manufacturing capacity by country and manufacturer, 2020	292
Table 5.2	Characteristics of existing hydrogen pipelines and desired features of new ones	307
Table 5.3	Announced designs for liquefied hydrogen tankers expected to be commercial before 2030	311
Table 5.4	Characteristics of types of underground geological storage for hydrogen.....	317
Table 5.5	Selected companies commercialising or planning to commercialise compressors suitable for hydrogen transmission and storage	324
Table 5.6	CO ₂ pipeline deployment for CO ₂ capture in the NZE Scenario, 2050	337
Table 5.7	Fossil fuel infrastructure with potential for repurposing for transporting or storing hydrogen and CO ₂	344
Table 5.8	Technical aspects of repurposing oil and gas pipelines for hydrogen and CO ₂ transport	345
Table 5.9	Existing and planned projects to repurpose natural gas pipelines to carry CO ₂	346
Table 6.1	Supply chain risk assessment framework.....	358
Table 6.2	Policy recommendations for secure, resilient and sustainable supply chains	364
Table 6.3	Accreditation requirements for clean energy sector workers by technology in selected countries, 2022	372
Table 6.4	Components of supply chain concentration	385
Table 6.5	Traceability standards, protocols and initiatives	426

Executive summary

The energy world is in the early phase of a new industrial age – the age of clean energy technology manufacturing. Industries that were in their infancy in the early 2000s, such as solar PV and wind, and the 2010s, such as EVs and batteries, have mushroomed into vast manufacturing operations today. The scale and significance of these and other key clean energy industries are set for further rapid growth. Countries around the world are stepping up efforts to expand clean energy technology manufacturing with the overlapping aims of advancing net zero transitions, strengthening energy security and competing in the new global energy economy. The current global energy crisis is a pivotal moment for clean energy transitions worldwide, driving a wave of investment that is set to flow into a range of industries over the coming years. In this context, developing secure, resilient and sustainable supply chains for clean energy is vital.

Every country needs to identify how it can benefit from the opportunities of the new energy economy, defining its industrial strategy according to its strengths and weaknesses. This 2023 edition of Energy Technology Perspectives (ETP-2023) provides a comprehensive inventory of the current state of global clean energy supply chains, covering the areas of mining; production of materials like lithium, copper, nickel, steel, cement, aluminium and plastics; and the manufacturing and installation of key technologies. The report maps out how these sectors may evolve in the coming decades as countries pursue their energy, climate and industrial goals. And it assesses the opportunities and the needs for building up secure, resilient and sustainable supply chains for clean energy technologies – and examines the implications for policy makers.

The new energy economy brings opportunities and risks

Clean energy transitions offer major opportunities for growth and employment in new and expanding industries. There is a global market opportunity for key mass-manufactured clean energy technologies worth around USD 650 billion a year by 2030 – more than three times today's level – if countries worldwide fully implement their announced energy and climate pledges. Related clean energy manufacturing jobs would more than double from 6 million today to nearly 14 million by 2030, with over half of these jobs tied to electric vehicles, solar PV, wind and heat pumps. As clean energy transitions advance beyond 2030, this would lead to further rapid industrial and employment growth.

But there are potentially risky levels of concentration in clean energy supply chains – both for the manufacturing of technologies and the materials on

which they rely. China currently dominates the manufacturing and trade of most clean energy technologies. China's investment in clean energy supply chains has been instrumental in bringing down costs worldwide for key technologies, with multiple benefits for clean energy transitions. At the same time, the level of geographical concentration in global supply chains also creates potential challenges that governments need to address. For mass-manufactured technologies like wind, batteries, electrolysers, solar panels and heat pumps, the three largest producer countries account for at least 70% of manufacturing capacity for each technology – with China dominant in all of them. The geographical distribution of critical mineral extraction is closely linked to resource endowments, and much of it is very concentrated. For example, Democratic Republic of Congo alone produces 70% of the world's cobalt, and just three countries account for more than 90% of global lithium production. Concentration at any point along a supply chain makes the entire supply chain vulnerable to incidents, be they related to an individual country's policy choices, natural disasters, technical failures or company decisions.

The world is already seeing the risks of tight supply chains, which have pushed up clean energy technology prices in recent years, making countries' clean energy transitions more difficult and costly. Increasing prices for cobalt, lithium and nickel led to the first ever rise in battery prices, which jumped by nearly 10% globally in 2022. The cost of wind turbines outside China has also been rising after years of decline, with the prices of inputs such as steel and copper about doubling between the first half of 2020 and the same period in 2022. Similar trends can be seen in solar PV supply chains.

Governments are racing to shape the future of clean energy technology manufacturing

Countries are trying to increase the resilience and diversity of clean energy supply chains while also competing for the huge economic opportunities. Major economies are acting to combine their climate, energy security and industrial policies. The Inflation Reduction Act in the United States is a clear articulation of this, but there is also the Fit for 55 package and REPowerEU plan in the European Union, Japan's Green Transformation programme, the Production Linked Incentive scheme in India that encourages manufacturing of solar PV and batteries, and China is working to meet and even exceed the goals of its latest Five-Year-Plan.

There are big dividends for countries that get their clean energy industrial strategies right. Project developers and investors are watching closely for the policies that can give them a competitive edge in different markets, and will respond to supportive policies. Only 25% of the announced manufacturing projects globally for solar PV are under construction or beginning construction

imminently – the number is around 35% for EV batteries and less than 10% for electrolyzers. The share is highest in China, where 25% of total solar PV and 45% of battery manufacturing is already at such an advanced stage of implementation. In the United States and Europe, less than 20% of announced battery and electrolyzer factories are under construction. The relatively short lead times of around 1-3 years on average to bring manufacturing facilities online mean that the project pipeline can expand rapidly in countries with an environment that is conducive to investment. Manufacturing projects announced, but not firmly committed, in one country today could end up actually being developed elsewhere in response to shifts in policies and market developments.

Greater efforts are needed to diversify and strengthen clean energy supply chains. China accounts for most of the current announced manufacturing capacity expansion plans to 2030 for solar PV components (around 85% for cells and modules, and 90% for wafers); for onshore wind components (around 85% for blades, and around 90% for nacelles and towers); and for EV battery components (98% for anode and 93% for cathode material). Hydrogen electrolyzers are the main exception, with around one-quarter of manufacturing capacity announcements for 2030 being in China and the European Union, respectively, and another 10% in the United States.

Clean energy supply chains benefit from international trade

International trade is vital for rapid and affordable clean energy transitions, but countries need to increase diversity of suppliers. For solar PV, many components are traded today, in particular wafers and modules. The share of international trade in global demand is nearly 60% for solar PV modules, with around half of the solar modules manufactured in China being exported – predominantly to Europe and the Asia Pacific region. The situation is similar for EVs, for which most of the trade in components flows from Asia into Europe, which imports around 25% of its EV batteries from China. Wind turbine components are heavy and bulky, but the international trade of towers, blades and nacelles is quite common. China is a major player in wind turbine component manufacturing, accounting for 60% of global capacity and half of total exports, most of which go to other Asian countries and Europe. In the United States, one of the largest wind power markets, the domestic content of blades and hubs is lower than 25%. For heat pumps, the share of international trade in global manufacturing is below 10%, with most of it from China to Europe.

The announced manufacturing pipeline to 2030 is very large for many clean energy technologies. If all announced projects to expand manufacturing capacities were to materialise and all countries implement their announced climate pledges, China alone would be able to supply the entire global market for solar PV

modules in 2030, one-third of the global market for electrolysers, and 90% of the world's EV batteries. Announced projects in the European Union would be sufficient to supply all of the bloc's domestic needs for electrolysers and EV batteries, but would continue to be highly dependent on imports for solar PV and wind, an area where it currently has a technological edge. The situation is somewhat similar in the United States, although further capacity additions are highly likely as a result of the Inflation Reduction Act. The current global pipeline of announced projects would exceed demand for some technologies (solar PV, batteries and electrolysers) and fall significantly short for others (wind components, heat pumps and fuel cells). This highlights the importance of clear and credible deployment targets from governments to limit demand uncertainty and guide investment decisions.

Critical minerals bring their own set of challenges

The mining of critical minerals is the only step in clean energy technology supply chains that depends on resource endowment alone. The long lead times for new mines, which can be well over ten years from the start of project development to first production, increase the risk that critical minerals supply becomes a major bottleneck in clean technology manufacturing. Moreover, the high geographical concentration of today's production creates security of supply risks, making international collaboration and strategic partnerships crucial. Clear policy signals about future deployment are particularly important to de-risk investments in this sector, as companies developing new mining capacity need to be confident that clean energy technologies further down the supply chain will be successfully scaled up in time.

The majority of announced projects for the processing and refining of key critical minerals are set to be located in China. These midstream processes tend to be energy-intensive. China accounts for 80% of the announced additional production capacity to 2030 for copper and dominates announced refining capacity of key metals used in batteries (95% for cobalt, and around 60% for lithium and nickel). Currently planned expansions of mineral processing capacity worldwide fall well short of the volumes that will be needed for rapid deployment of clean energy technologies. Polysilicon for solar PV supply chains is the only area in which a surplus of capacity by 2030 can currently be expected.

Mitigating risks in critical mineral supplies requires a new, more diversified network of diverse international producer-consumer relationships. These will be based not only on mineral resources, but also on the environmental, social and governance standards for their production and processing. These new partnerships need to be balanced in ways that offer resource-rich producers, especially in developing economies, the opportunity to move beyond primary production. Stockpiling options can also provide safeguards against disruption, but

a comprehensive suite of policies in support of minerals security needs to include attention on the demand side, notably via recycling programmes and support for technology innovation.

Countries' clean energy industrial strategies need to reflect their strengths and weaknesses

For most countries, it is not realistic to compete effectively across all parts of the relevant clean energy technology supply chains. They need not to do so. Competitive specialisms often arise from inherent geographic advantages, such as access to low-cost renewable energy or the presence of a mineral resource, which can lead to lower production costs for energy and material commodities. But they can also arise from other attributes, like a large domestic market, a high-skilled workforce or synergies and spillovers stemming from existing industries. Holistically assessing and nurturing these competitive advantages should form a central pillar of governments' industrial strategies, designed in accordance with international rules and complemented by strategic partnerships.

Energy costs will continue to be a major differentiator in the competitiveness of countries' energy-intensive industry sectors. Industrial competitiveness today is closely linked to energy costs, especially natural gas and electricity, which vary greatly between regions. This remains the case in the clean energy transition. For example, production costs of hydrogen from renewable electricity could be much lower in China and the United States (USD 3-4/kg) than in Japan and Western Europe (USD 5-7/kg) using the best resources in those countries today, translating into similar differences in production costs for derivative commodities, such as ammonia and steel. As countries make progress towards their climate pledges, with renewable electricity costs continuing their decline and electrolyser costs falling rapidly, the cost difference between regions is likely to shrink somewhat, but competitiveness gaps will remain. Carefully considering where in the supply chain to specialise domestically, and where it might be better to establish strategic partnerships or make direct investments in third countries, should form key considerations of countries' industrial strategies.

New infrastructure will form the backbone of the new energy economy in all countries. This covers areas such as the transportation, transmission, distribution or storage of electricity, hydrogen and CO₂. Building clean energy infrastructure can take 10 years or more, typically involving large civil engineering projects that have to adhere to extensive local planning and environmental regulations. While construction is in most cases a relatively efficient process, taking 2-4 years on average, planning and permitting can cause delays and create bottlenecks, with

the process taking 2-7 years, depending on the jurisdiction and type of infrastructure. Lead times for infrastructure projects are usually much longer than for the power plants and industrial facilities that connect to them.

The story of the new energy economy is still being written – supply chains are central to the narrative

Industrial strategies for clean energy technology manufacturing require an all-of-government approach, closely coordinating climate and energy security imperatives with economic opportunities. This will mean identifying and fostering domestic competitive advantages; carrying out comprehensive risk assessments of supply chains; reducing permitting times, including for large infrastructure projects; mobilising investment and financing for key supply chain elements; developing workforce skills in anticipation of future needs; and accelerating innovation in early-stage technologies. Every country has a different starting point and different strengths, so every country will need to develop its own specific strategy. And no country can go it alone. Even as countries build their domestic capabilities and strengthen their places in the new global energy economy, there remain huge gains to be had from international co-operation as part of efforts to build a resilient foundation for the industries of tomorrow.

Introduction

Purpose of this report

The International Energy Agency (IEA) *Energy Technology Perspectives (ETP)* technology flagship series of reports has been providing critical insights into key technological aspects of the energy sector since 2006. Clean energy technologies and innovation are vital to meet the policy goals of energy security, economic development and environmental sustainability. Cost-effective energy and environmental policy making must be based on a clear understanding of the potential for deploying these technologies. *ETP* seeks to help achieve this goal by assessing the opportunities and challenges associated with existing, new and emerging energy technologies, and identifying how governments and other stakeholders can accelerate the global transition to a clean and sustainable energy system.

The Covid-19 pandemic and the Russian Federation's (hereafter, "Russia") invasion of Ukraine have critically disrupted global energy and technology supply chains, leading to soaring gas, oil and coal prices, as well as shortages of critical minerals, semiconductors and other materials and components needed to manufacture clean energy technologies. The current global energy crisis poses a threat to near-term economic prospects and is threatening to slow the rollout of some clean energy technologies, but it also strengthens the economic case for accelerating the shift away from fossil fuels by massively raising investments in renewables, energy efficiency and other clean energy technologies. The recent spate of extreme weather events across the planet reminds us of the urgent need for radical action to rein in emissions of greenhouse gases. As the IEA has repeatedly stressed, the world does not need to choose between tackling the energy crisis and the climate crisis. The social and economic benefits of accelerating clean energy transitions are as huge as the costs of inaction.

Secure, resilient and sustainable supply chains for manufacturing clean energy technologies and producing low-emission energy commodities are central to the global energy transition. These supply chains depend largely on minerals and on an array of materials and components derived from them, rather than on fossil fuel supplies. As a result, energy security considerations will increasingly be about access to those resources and goods. Important lessons can be drawn from established markets and technologies such as solar photovoltaics (PV) in shaping emerging markets for batteries, low-emission hydrogen and other technologies that are poised to play key roles in the clean energy transition.

The primary purpose of this edition of *ETP* is to help government and industry decision makers overcome hurdles in developing and expanding the clean energy technology¹ supply chains the world needs to reach net zero emissions by mid-century. Through the lenses of energy security, resiliency and sustainability, *ETP-2023* focuses throughout on the opportunities and risks involved in scaling up clean energy and technology supply chains in the years ahead. It sets out where key clean energy and technology supply chains stand today and assesses how quickly they need to expand for the world to be on track for net zero emissions, and it identifies vulnerabilities and risks in adapting them to a net zero world as well as emerging opportunities to establish the new global energy economy. It also examines how governments can design more effective policies and strategies to encourage greater supply chain security, resiliency and sustainability.

ETP-2023 builds on the 2020 revamp of this series, aimed at improving its usefulness and relevance for policy makers and other stakeholders. It draws on and updates the IEA's ongoing analysis of critical minerals and recent detailed assessments of technology supply chains for electric vehicle (EV) batteries and solar PV, as well as the IEA's extensive clean energy technology tracking and analytical activities. *ETP* analysis also benefits from IEA Technology Collaboration Programme expertise and research provided by experts around the world who support this work with technology data and analytical insights.

Clean energy and technology supply chains

Energy and technology supply chains refer to the sequences of steps, or stages, required to deliver a technology or an energy service to the market. They include extracting natural resources (such as minerals), producing materials and fuels, manufacturing components and assembling them into a technology or system, installing and operating that technology, and managing wastes generated during its operating lifetime and when it is being dismantled at the end of its lifespan. An energy technology comprises a combination of hardware, techniques, skills, methods and processes used to produce energy and provide energy services, i.e. energy production, transformation, storage, transportation and use.

In this report we distinguish between technology supply chains and energy supply chains, based on the final service delivered:

¹ Clean energy technology comprises those technologies that result in minimal or zero emissions of carbon dioxide (CO₂) and pollutants. For the purposes of this report, clean energy technology refers to low or near zero emissions technologies that do not involve the production or transformation of fossil fuels – coal, oil and natural gas – unless they are accompanied by carbon capture, utilisation and storage (CCUS) and other anti-pollution measures.

- **Technology supply chains** refer to the different steps needed to install a technology, with inputs of materials, components and services involved at each stage. In the case of clean energy technologies, the main steps include the extraction of minerals; the processing of those minerals into usable materials; the manufacturing of components; their assembly into finished equipment; the installation of that equipment; its operation; and its decommissioning and reuse or recycling of certain components. These technologies include supply-side equipment, such as solar PV systems (ranging from household systems to large utility-scale plants) and electrolyzers to produce hydrogen, as well as end-use equipment such as EVs, heat pumps and hydrogen-powered fuel cell vehicles.
- **Energy supply chains** refer to the different steps needed to supply a fuel or final energy service to end users, usually involving trade of that energy commodity along and across technology supply chains. Steps include power generation or fuel transformation, as well as their transportation, transmission, distribution and storage. Examples include the supply of renewable electricity (such as solar PV and wind power) and low-emission hydrogen and synthetic hydrocarbon fuels, such as synthetic kerosene.

Technology supply chains and energy supply chains are interrelated. Producing, generating, transporting and storing any form of energy requires technologies, which need to be manufactured and brought into service. In parallel, all the different steps along the technology supply chain consume energy and thus depend on energy supply chains.

Figure I.1 Steps and interdependencies of technology and energy supply chains

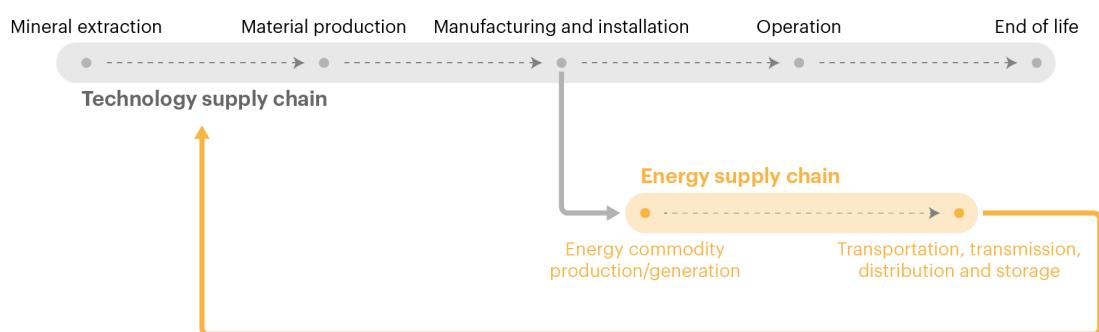

IEA. CC BY 4.0.

Energy and technology supply chains are interdependent, as one is unable to operate without the other.

Recent trends in technology costs and energy prices illustrate the interlinkages between the two types of supply chains. The prices of many minerals and metals that are essential for some leading clean energy technologies have soared in the last few years, due to a combination of rising demand, disrupted supply chains,

concerns about future supply and rising energy prices. For example, the price of lithium has nearly doubled since the beginning of 2022 (see Chapter 2). Cathode materials such as lithium, nickel, cobalt and manganese, which are essential for making lithium-ion batteries, accounted for less than 5% of battery pack costs in the middle of the last decade when there were only a handful of battery gigafactories; that share has risen to over 20% today.

Scope and analytical approach

Risk assessment framework for supply chains

Disruptions to clean energy technology supply chains could have a major impact on the world's ability to achieve climate and energy goals. Understanding the risk profile of each element of the supply chain is a key step in determining where to focus efforts to enhance security, resilience and sustainability, and in developing policies to address potential vulnerabilities. These profiles can look very different depending on the country, region and technology and will change over time as new technologies and materials emerge and mature, and as markets develop.

Making supply chains secure, resilient and sustainable can only be achieved through a comprehensive and co-ordinated approach. This means taking action to develop supply chains that can meet the needs of a net zero pathway and that can absorb, accommodate and recover from short-term shocks and adjust to long-term changes in supply, including periodic material shortages, the effects of climate change and natural disasters, and other potential market disruptions. The need to reduce the emissions intensity and environmental impact of clean energy technology supply chains themselves is particularly urgent.

The IEA has developed a risk assessment framework that both government and businesses can use to capture the risks and vulnerabilities of supply chains. It was first presented in *Securing Clean Energy Technology Supply Chains*, published in July 2022 (IEA, 2022a). For the purposes of *ETP-2023*, the analysis has been significantly expanded to provide a comprehensive risk-assessment framework for technology and energy supply chains based on the combined assessment of likelihood and impact metrics relevant to four identified potential risks: insufficient scaleup pace, and supply insecurity, inflexibility and unsustainability.

The framework is designed to be applied to current supply chain structures to assess how well they can adapt and respond in the short to medium term. This report uses it to provide a global perspective, but it can be applied at the national or regional level.

Scenario analysis

Analysis in this report is underpinned by global projections of clean energy technologies derived from the IEA's Global Energy and Climate (GEC) model (IEA, 2022b), a detailed bottom-up modelling framework composed of several interlinked models covering energy supply and transformation, and energy use in the buildings, industry and transport sectors. The modelling framework includes 26 regions or countries covering the whole world (see Annex). The *ETP-2023* projection period is 2021 to 2050. The most recent year of complete historical data is 2020, though preliminary data are available for some countries and sectors for parts of 2021 and have been used to adjust the projections.

We employ two scenarios to describe possible energy technology pathways:

- The **Net Zero Emissions by 2050 (NZE) Scenario** – the central scenario in this report – is a normative scenario that sets out a pathway to stabilise global average temperatures at 1.5°C above pre-industrial levels. The NZE Scenario achieves global net zero energy sector CO₂ emissions by 2050 without relying on emissions reductions from outside the energy sector. In doing so, advanced economies reach net zero emissions before developing economies do. The NZE Scenario also meets the key energy-related UN Sustainable Development Goals, achieving universal access to energy by 2030 and securing major improvements in air quality.
- The **Announced Pledges Scenario (APS)** assumes that governments will meet, in full and on time, all the climate-related commitments they have announced, including longer-term net zero emissions targets and Nationally Determined Contributions (NDCs), as well as commitments in related areas such as energy access. It does so irrespective of whether these commitments are underpinned by specific policies to secure their implementation. Pledges made in international fora and initiatives on the part of businesses and other non-governmental organisations are also taken into account wherever they add to the ambition of governments.

Neither scenario should be considered a prediction or forecast. Rather, they are intended to offer insights into the impacts and trade-offs of different technology choices and policy targets, and to provide a quantitative framework to support decision making in the energy sector and strategic guidance on technology choices for governments and other stakeholders. The focus of the analysis in *ETP-2023* is on the technology requirements of the NZE Scenario; the APS is employed with a view to understanding geographical concentration and regional needs. The scenarios and results are consistent with those presented in the 2022 *World Energy Outlook* (IEA, 2022c).

Selected energy and technology supply chains

This report analyses six clean energy and technology supply chains in detail (Figure I.2). They were selected based on their critical importance to the clean energy transition described in the NZE Scenario. Together, they contribute around half of the cumulative emissions reductions to 2050 in that scenario. Three are clean energy supply chains – for low-emission electricity (including solar PV and wind with their respective technology supply chains); low-emission hydrogen (including technology supply chains for electrolysers and natural gas-based plants with carbon capture and storage [CCS]); and low-emission synthetic hydrocarbon fuels (including technology supply chains for direct air capture [DAC] and bioenergy with carbon capture [BECC] to provide CO₂, connected to the low-emission hydrogen supply chain). The three others are clean technology supply chains – for electric cars (including the battery supply chain); fuel cell trucks (including the fuel cell supply chain); and heat pumps for buildings.

Figure I.2 Key elements for each step in selected clean energy and technology supply chains

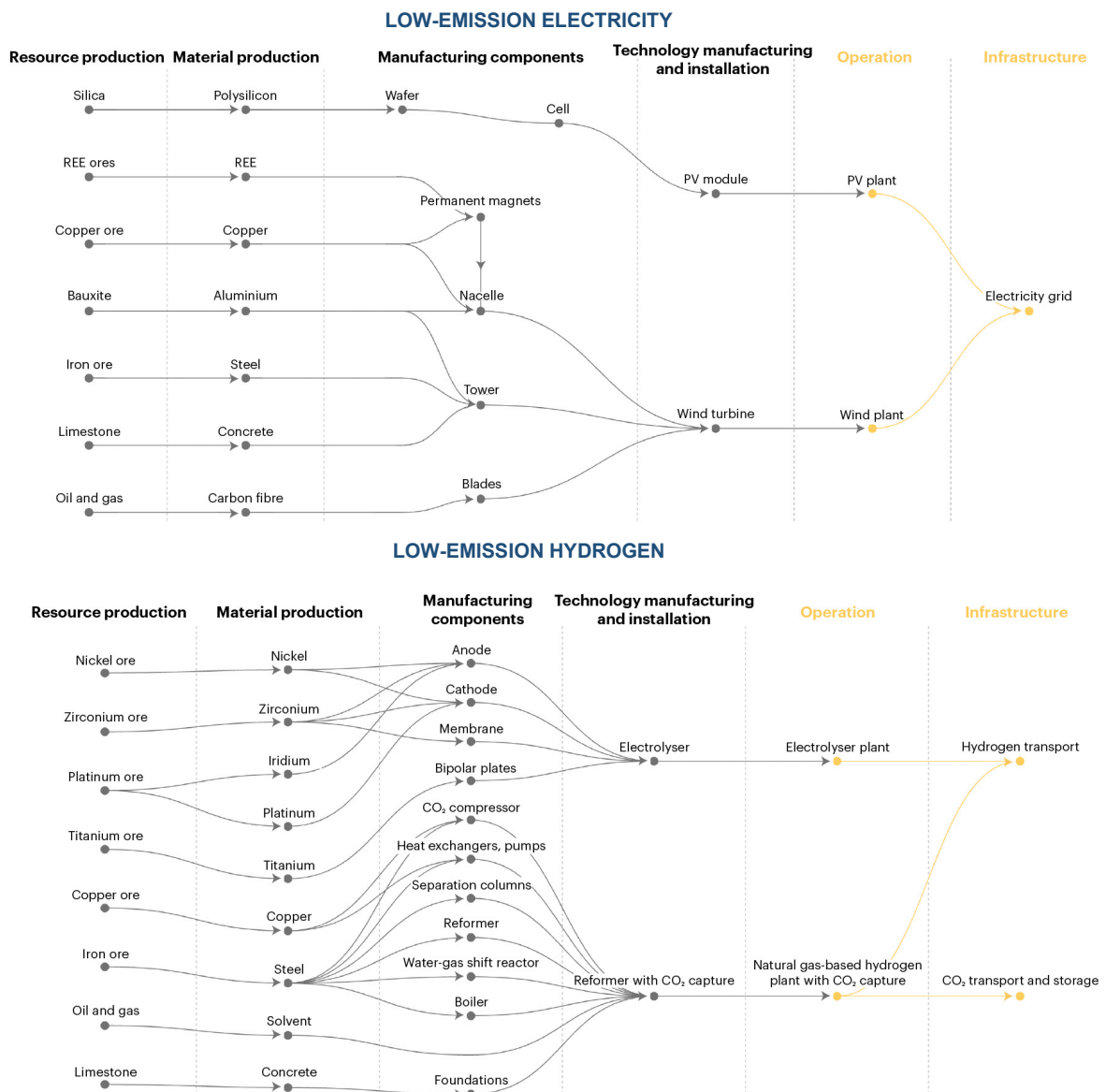

LOW-EMISSION SYNTHETIC HYDROCARBON FUELS

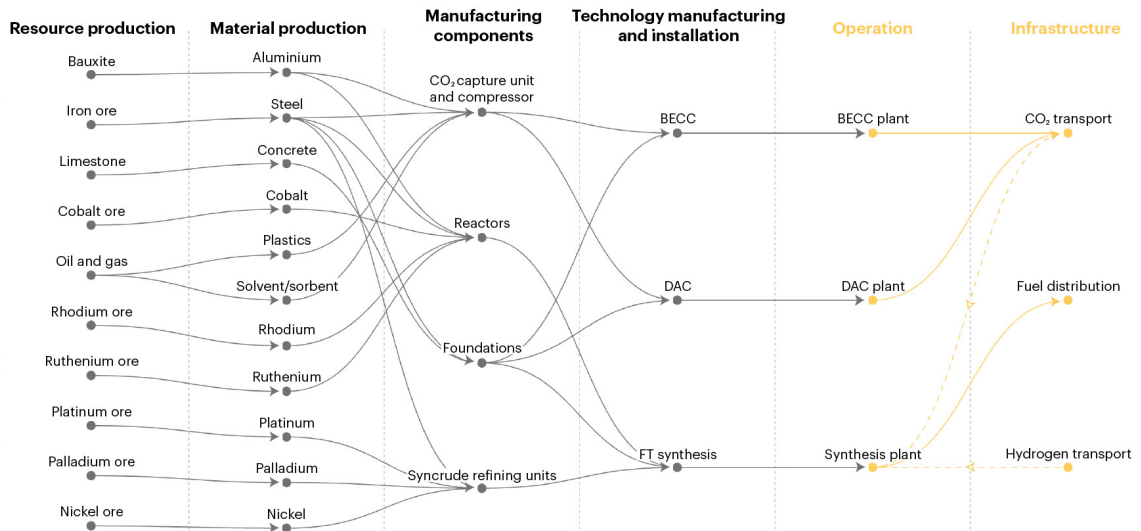

BATTERY ELECTRIC VEHICLES

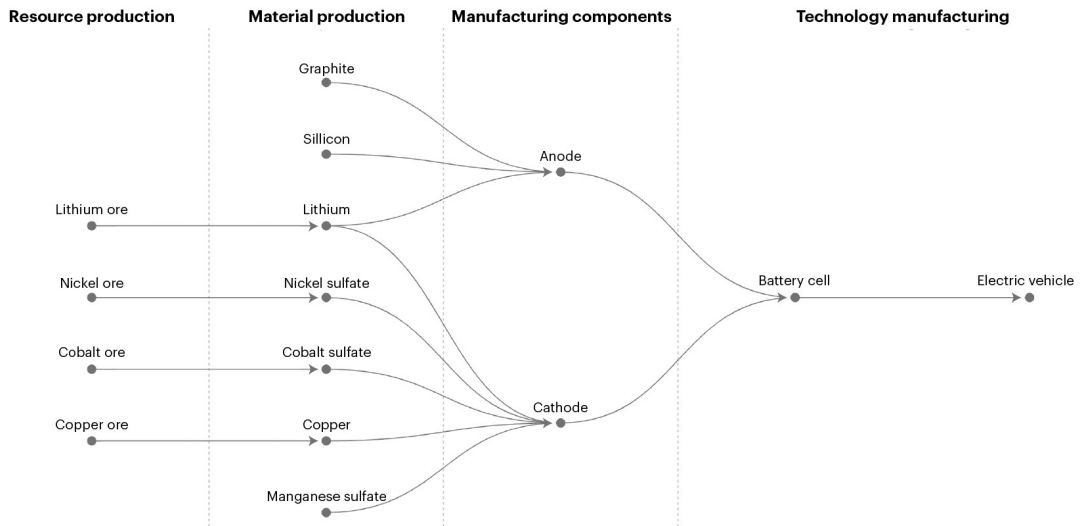

HEAT PUMPS

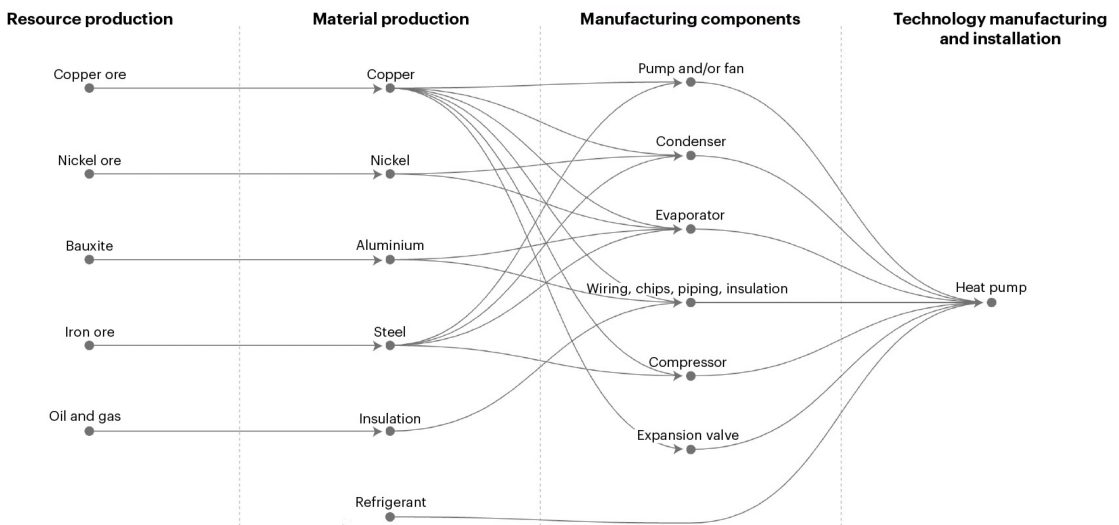

FUEL CELL TRUCKS

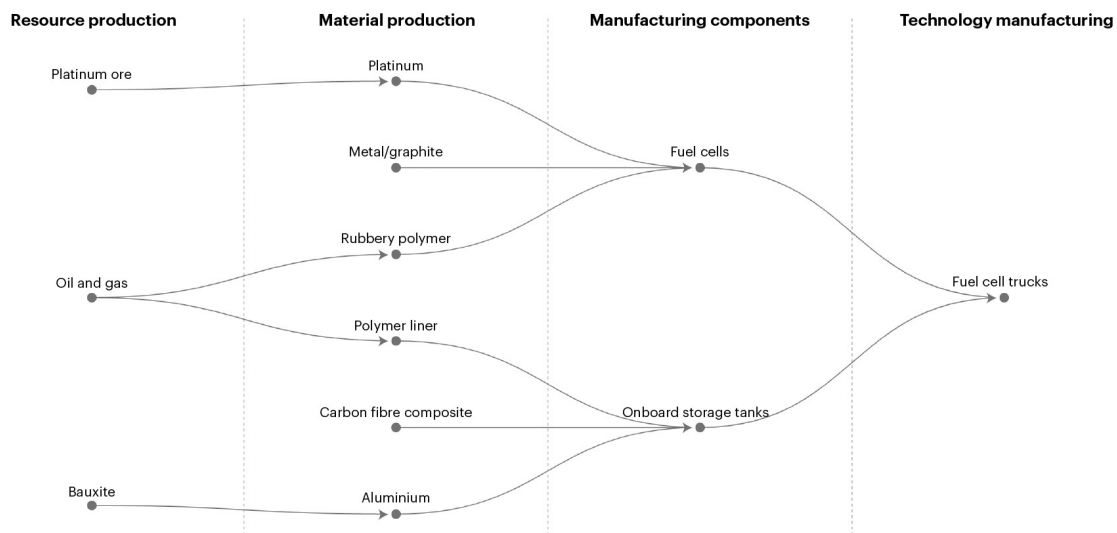

IEA. CC BY 4.0.

Notes: BECC = bioenergy with carbon capture. DAC = direct air capture. FT = Fischer-Tropsch.

ETP-2023 studies six selected clean energy and technology supply chains in detail.

Report structure

Chapter 1 reviews the current status of the global clean energy transition and outlines the extent of the changes required to clean energy and technology supply chain to put the world on the NZE Scenario's net zero pathway, as well as some potential risks that could arise.

Chapter 2 assesses in detail how the key clean energy and technology supply chains function today and their vulnerabilities as clean energy transitions advance, focusing on the link between geographic concentration and security, resilience to market shocks and environmental performance.

Chapter 3 quantifies global mineral and material needs for the transition to net zero emissions and analyses the extent to which current expansion plans are compatible with that trajectory. It also discusses the policy and market factors driving investments in key regions and the main corporate strategies in this step of the supply chain.

Chapter 4 assess prospects for the supply of mass-manufactured and large-scale site-tailored clean energy technologies, focusing on the expansion of manufacturing and installation capacity based on current and announced construction activity. Like Chapter 3, Chapter 4 also discusses the policy and market factors driving investments in key regions and the main corporate strategies in this step of the supply chain.

Chapter 5 analyses how and at what pace energy and CO₂ infrastructure needs to be transformed to cost-effectively sustain the clean energy supply chains that will be needed for net zero emissions, focusing on electricity, hydrogen and CO₂ transportation, transmission, distribution and storage.

Chapters 6 sets out how policy makers can support the development and expansion of secure, resilient and sustainable supply chains, the tools at their disposal and how best to use them, drawing on recent experience around the world.

References

- IEA (International Energy Agency) (2022a), Securing Clean Energy Technology Supply Chains, <https://www.iea.org/reports/securing-clean-energy-technology-supply-chains>
- IEA (2022b), Global Energy and Climate Model, <https://www.iea.org/reports/global-energy-and-climate-model>
- IEA (2022c), World Energy Outlook, <https://www.iea.org/reports/world-energy-outlook-2022>

Chapter 1. Energy supply chains in transition

Highlights

- Momentum for clean energy transitions is accelerating, driven by increasingly ambitious energy and climate policies, technological progress and renewed energy security concerns following Russia's invasion of Ukraine. Clean energy investment reached USD 1.4 trillion in 2022, up 10% relative to 2021 and representing 70% of the growth in total energy sector investment. Despite this important progress, fossil fuels still account for 80% of the primary energy mix.
- Clean energy technology deployment must accelerate rapidly to meet climate goals. In the Net Zero Emissions by 2050 (NZE) Scenario, global production of electric cars increases six-fold by 2030; renewables account for over 60% of power generation (up from 30% today); and electricity demand increases by 25%, accounting for nearly 30% of total final consumption (up from 20% today). If delivered in full, announced projects to expand clean technology manufacturing capacity would meet the needs for 2030 in the NZE Scenario for solar PV modules and approach that required for EV batteries, but would fall short in other areas, leaving gaps of 40% for electrolysers and 60% for heat pumps.
- The transition to clean energy hinges on clean energy technology supply chains. USD 1.2 trillion of cumulative investment would be required to bring enough capacity online for the supply chains studied in *ETP-2023* to be on track with the NZE Scenario's 2030 targets. Announced investments cover around 60% of this total. Given project lead times, most investments are required during 2023-2025, at an average of USD 270 billion per year during that period, which is nearly seven times the average rate of investment over 2016-2021.
- Critical materials like copper, lithium, cobalt and nickel are changing the energy security paradigm. Manufacturing a typical-size electric car requires five times as much of these materials as a regular car. Anticipated supply expansion suggests that production could fall well short of NZE Scenario requirements for 2030, with deficits of up to 35% for lithium mining and 60% for nickel sulfate production.
- Lead times to establish new supply chains and expand existing ones can be long, requiring policy interventions today. Opening mines or deploying clean energy infrastructure can take more than a decade. Building a factory or ramping up operations for mass-manufactured technologies requires only around 1-3 years.
- Clean energy sector jobs in the NZE Scenario soar from 33 to 70 million over 2021-2030, offsetting the loss of 8.5 million in fossil fuel-related sectors. Building a large, skilled workforce is key to meeting net zero targets, but labour and skills shortages in expanding clean energy industries are already creating bottlenecks.

The clean energy transition

Recent trends in energy technologies

The move to clean energy is accelerating

The global clean energy transition is accelerating, driven by a combination of policy, technological change and economics. The need to reduce greenhouse gas emissions drastically and urgently in the face of ever more startling evidence of global climate change is now widely accepted, reflected in increasingly ambitious national goals. The global energy crisis following the Russian Federation's (hereafter, "Russia") invasion of Ukraine has bolstered energy security concerns about supply of conventional fuels such as oil and gas, providing further impetus to the need and policy support for clean energy technologies. As of the end of November 2022, 87 countries and the European Union had announced pledges to reduce emissions to net zero this century, covering over 85% of the world's emissions and 85% of its gross domestic product. Notable announcements since 2021 include the People's Republic of China's (hereafter, "China") target of carbon neutrality by 2060 (IEA, 2021a), India's net zero emissions by 2070 goal (Government of India, 2022) and Indonesia's net zero emissions by 2060 target (IEA, 2022a). If all announcements and targets are met in full and on time, they will be enough to hold the rise in global temperatures to around 1.7°C in 2100 (IEA, 2022b; IEA, 2022c).

Over the last decade, the uptake of clean energy technologies and the supply of energy from non-fossil sources, notably renewables, has accelerated rapidly. In 2022, renewables accounted for 30% of global power generation, up from below 20% in 2010, with notable increases in solar PV, wind, hydropower and bioenergy output (IEA, 2022d). Electrification is accelerating across all end-use sectors. In transport, sales of electric cars exceeded 10 million in 2022, or 13% of the global car market, bringing their total number on the world's roads to over 25 million, up from practically zero in 2010 (IEA, 2022e). There were more than 1 000 gigawatts thermal (GW_{th}) of heat pump capacity operating worldwide in 2021, up from around 500 GW_{th} in 2010, with sales growing 13% relative to 2020.²

Investment in clean energy technology is increasing quickly and exceeded USD³ 1.4 trillion in 2022, accounting for nearly 70% of year-on-year growth in overall energy investment, and up from about USD 1 trillion in 2015 (IEA, 2022f).

² Heat pumps included in this analysis are electric, and are those used primarily for heating (space and/or water) in buildings and the ones for which heating function is just as important as its cooling function, aiming to exclude to the extent possible air-air reversible heat pumps units bought primarily for space cooling. They include both centralised and decentralised units in buildings.

³ All USD values in this report are expressed in real terms based 2021 prices.

In the case of electric cars, global spending by governments and consumers doubled to about USD 280 billion in 2021, about ten times more than in 2015. This increase took place despite difficult market conditions and manufacturing constraints: the combined revenues of the world's 25 largest car manufacturers stagnated between 2015 and 2021, before rebounding in 2022. Renewables, power grids and energy storage in 2022 accounted for more than 80% of the nearly USD 1 trillion of total power sector investment, led by solar PV, up from 75% of the USD 800 billion invested in 2015, while the share of fossil fuel power fell from about 20% to 10% over the same period. Aggregate investment in oil, gas and coal supply amounted to just above USD 800 billion in 2022, down from over USD 1 trillion in 2015. Capital spending by oil and gas companies⁴ on clean energy technologies has risen in recent years, expected to reach just over 5% of their total upstream investment in 2022, up from 0.5% in 2015.

The world still relies heavily on fossil fuels

Despite the rapid recent growth in clean energy technologies, the world still relies predominantly on fossil fuels for its energy supply (Figure 1.1). In fact, growth in clean energy supply since 2000 has been dwarfed by that of oil, gas and coal, especially in the emerging and developing economies. In those countries, the share of fossil fuels in total primary energy supply increased from 77% in 2000 to 80% in 2021, mainly due to a jump in coal, from 27% to 35%. In the advanced economies, the share dropped from 82% to 77% over the same period. As a result, the overall share of fossil energy in the global energy mix has remained almost constant at about 80%.

Oil remains the single largest source of primary energy, making up 29% of total energy supply in 2021 (down from 37% in 2000), followed by coal at 26% (up from 23%) and natural gas at 23% (up from 21%). Bioenergy is still the single largest source of non-fossil energy, accounting for around 10% of total primary energy use in 2021, though over one-third is in the form of traditional biomass, often used in unsustainable and polluting ways. Nuclear power makes up 5% of supply, hydropower around 2%, and solar and wind together a mere 2%. While electrification has accelerated over the last two decades, fossil fuels still dominate energy end use, accounting for around 35% of total energy use in buildings and 95% in transport.

⁴ Includes the majors BP, Chevron, ConocoPhillips, Eni, ExxonMobil, Shell and TotalEnergies, as well as ADNOC (Abu Dhabi National Oil Company), CNPC (China National Petroleum Corporation), CNOOC (China National Offshore Oil Corporation), Equinor, Gazprom, Kuwait Petroleum Corporation, Lukoil, Petrobras, Repsol, Rosneft, Saudi Aramco, Sinopec and Sonatrach.

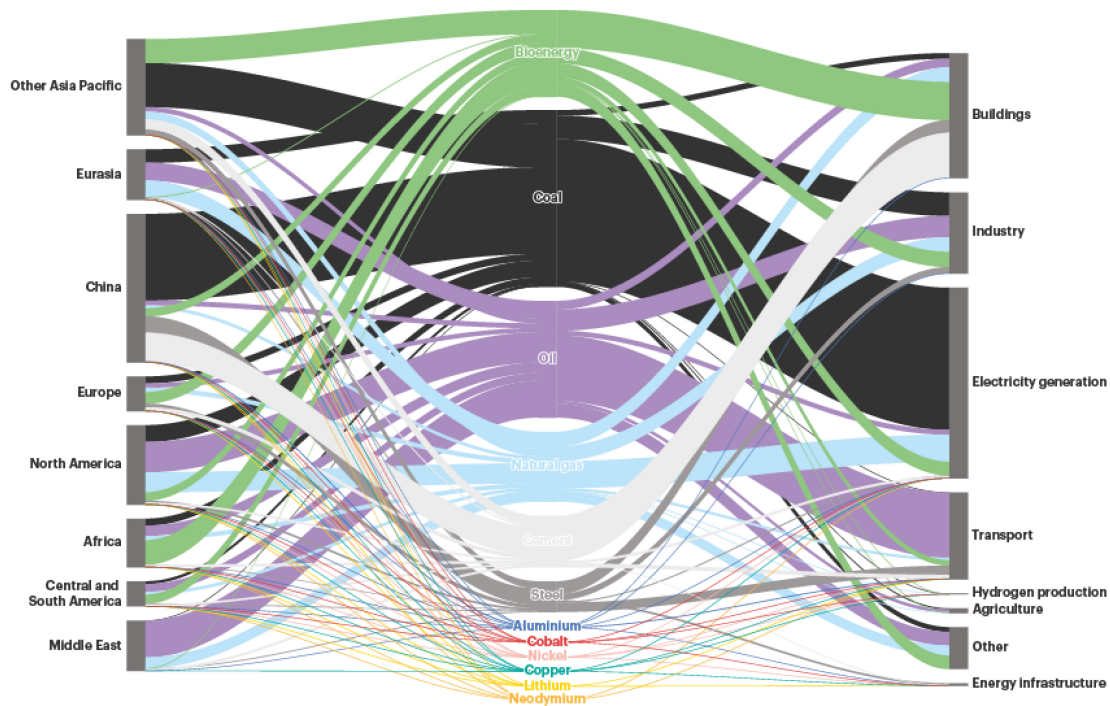
Figure 1.1 Global mass-based resource flows into the energy system, 2021

IEA. CC BY 4.0.

Notes: Physical mass flows of fuels and materials in the energy system, in million tonnes. The “energy system” includes: devices that directly produce or consume energy (e.g. solar panels and motors); equipment and structures that house energy-consuming devices and in turn can passively have an impact on energy consumption (e.g. building envelopes and car bodies); infrastructure that directly transports energy or CO₂ (e.g. electricity grids and CO₂ pipelines); and infrastructure whose build-out could be directly affected by shifts in technology due to clean energy transitions (e.g. rail infrastructure and roads). Industry material demand includes that from equipment but not the plant shell. Region of production refers to region of extraction for fuels and minerals, and production for bulk materials (steel, cement, aluminium). For critical minerals (copper, lithium, nickel, cobalt and neodymium), volumes refer to the materials (metals) derived from them. A similar graph for the Net Zero Emissions by 2050 (NZE) Scenario for 2050 is in Chapter 3.

Sources: IEA analysis based on IEA data; USGS (2022).

Despite the rapid recent growth in clean energy technologies and demand for metals critical to them, the world still relies primarily on coal, oil and gas to meet its energy needs.

In addition to the direct use of energy, end-use sectors consume large amounts of energy embedded in materials, such as cement for infrastructure and buildings, steel for vehicles and manufacturing goods, and chemicals for fertilisers and consumer goods. The production of these bulk materials today also relies mainly on fossil fuels, either for combustion or as feedstock. In 2021, coal made up around 75% of the energy used in global steel production and more than half of that used to make cement, while about 70% of chemicals production was based on oil or natural gas. The demand for so-called “critical minerals”,⁵ from which

⁵ In this report, five main critical minerals are analysed: copper, lithium, cobalt, nickel and neodymium. They were selected based on their use in key clean energy technologies, potential constraints in their supply and risks relative to the geographical concentration of their production.

metals such as copper, nickel and cobalt are produced, has been increasing briskly in recent years, driven by the deployment of clean energy technologies such as batteries, yet their combined production by mass represents just 0.3% of that of coal today. The extraction and processing of critical minerals typically relies on fossil fuels at present.

Much of the momentum for clean energy is recent and has thus yet to translate into major change in global energy supply (IEA, 2022g). Most countries have been strengthening policy support for clean energy since the Paris Agreement in 2015, and even more so since 2020 as part of Covid-19 economic recovery packages. For example, the United States passed the Inflation Reduction Act in 2022, authorising USD 370 billion in spending on energy and climate change (US Congress, 2022). In the wake of Russia's invasion of Ukraine, the European Union adopted the REPowerEU plan, which is expected to mobilise an additional EUR 210 billion in clean energy technology investment over five years and support the Fit for 55 package – a set of proposals to revise and update EU legislation and to put in place new initiatives with the aim of reducing EU emissions by at least 55% by 2030 (EC, 2022; European Council, 2022). At the Global Clean Energy Action Forum co-organised by Mission Innovation and the Clean Energy Ministerial, 16 countries collectively announced USD 94 billion in spending for clean technology demonstration projects by 2026, following IEA analysis of global needs for net zero (US Department of Energy, 2022; IEA, 2022h). Japan has established a roadmap to reach net zero by 2050 with support for developing emerging technologies through the JPY 2 trillion Green Innovation Fund (Japan, METI, 2021; NEDO, 2021). China's 14th Five-Year Plan contains action plans for technology development aimed at achieving a peak in CO₂ emissions by 2030 (China, NEA, 2022; China, NDRC, 2021). India is increasing supply chain investments to boost domestic manufacturing in strategic industries including batteries (over USD 2 billion), cars (over USD 3 billion), solar PV (nearly USD 600 million) and steel (USD 800 million) through the Production Linked Incentive scheme over the 2022-2027 period (India, MCI, 2021a and 2021b; India, MHI, 2022a and 2022b; India, MNRE, 2022; India, Union Cabinet, 2020).

Clean energy technology needs for net zero

Net zero calls for a deep transformation of the energy sector

Achieving global net zero emissions of CO₂ by 2050 requires curbing the growth in energy demand alongside a radical change in the energy mix, involving a wholesale shift to renewable and other clean energy sources and technologies (Figure 1.2). In the NZE Scenario, behavioural changes, improvements in energy efficiency, and switching to renewables enable a fall in total primary energy supply

by 10% between 2021 and 2030, despite the global economy growing by nearly a third. Total final consumption falls by 9% over the same period. The annual rate of energy intensity improvement nearly triples to more than 4% per year compared with the previous decade. Between 2030 and 2050, global demand falls more slowly, by just 15% in total, as the scope for further energy conservation efforts and efficiency improvements diminishes, and growing population and economic activity continue to drive up underlying demand for energy services.

Renewables – led by solar PV and wind – see the biggest increase in supply to 2050 in the NZE Scenario, complemented by significant increases in nuclear. Solar output jumps 23-fold and that of wind 13-fold, while nuclear power doubles between 2021 and 2050. By 2050, solar and wind together make up about 40% of total primary energy supply and nuclear 12%. Total capacity additions of renewables quadruple from 300 GW in 2021 to nearly 1 200 GW in 2030, their share of total power generation reaching over 60%; additions slow to about 1 100 GW by 2050 as the need to replace existing fossil fuel-based capacity diminishes, with renewables accounting for about 90% of generation by then.

Unabated fossil fuels provided around 65% of total final consumption in 2021, excluding fossil fuel use for non-energy purposes such as chemical feedstock. In the NZE Scenario, this share falls to around 55% in 2030 and to 15% by 2050. In absolute terms, the consumption of bioenergy in end-use sectors rises modestly over 2021-2050, but this masks a shift in its composition: the use of modern bioenergy rises sharply while its traditional use is phased out completely by 2030 as full access to modern energy is achieved in all countries.

Figure 1.2 Global total primary energy supply in the NZE Scenario

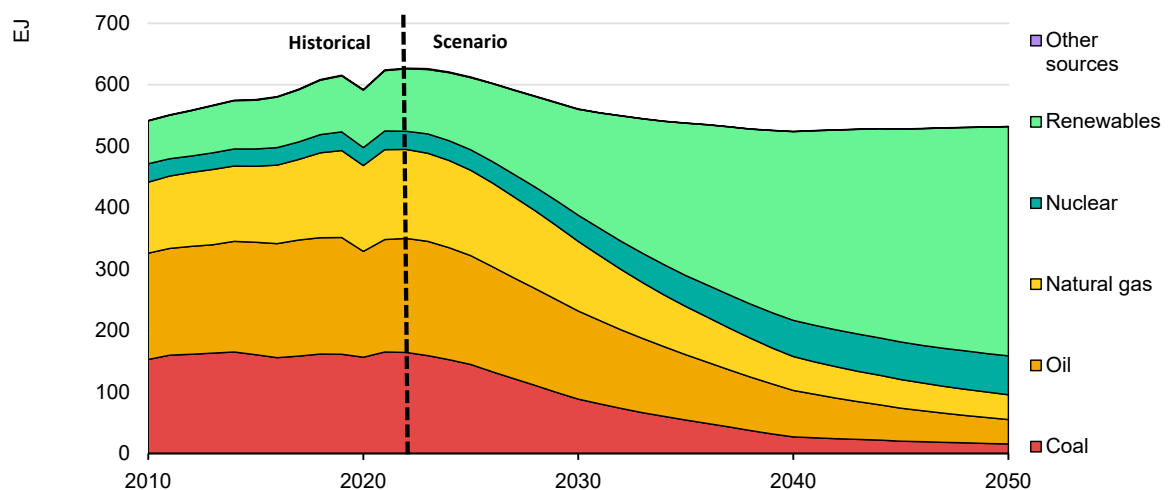

IEA. CC BY 4.0.

Renewables and nuclear displace most fossil fuel use in the NZE Scenario, with the share of fossil fuels plunging from almost 80% in 2021 to less than 20% in 2050.

Electricity becomes the largest energy vector, with demand more than doubling between 2021 and 2050, by which time it meets more than half of total final consumption (Figure 1.3). Total electricity generation grows by 3.5% per year to 2050 to meet that demand. Hydrogen and hydrogen-based fuels emerge as significant end-use forms of energy, especially after 2030, being deployed mainly in heavy industry and long-distance transport; their share of total final consumption reaches nearly 10% in 2050. The share of bioenergy reaches around 15% in 2050. Carbon capture, utilisation and storage (CCUS) plays an increasingly important role: CO₂ capture grows from around 0.04 Gt in 2021 to 1.2 Gt in 2030 and 6.2 Gt in 2050, with industry and fuel transformation sectors accounting for more than 40%, direct air capture (DAC) for around 5%, and power and heat generation for the rest by then.

The transformation of the global energy system described in the NZE Scenario results in a rapid decline in energy sector CO₂ emissions (energy-related and from industrial processes), falling by about 30% by 2030 and by 95% by 2050 relative to 2021. Residual emissions in 2050 from sectors where reducing them is technically difficult and costly, such as aviation, shipping, road freight and heavy industry, are entirely compensated by carbon removal from bioenergy with carbon capture and storage, which removes CO₂ from the atmosphere indirectly, and direct air capture with storage, resulting in overall net zero emissions.

Figure 1.3 Global energy flows in the NZE Scenario

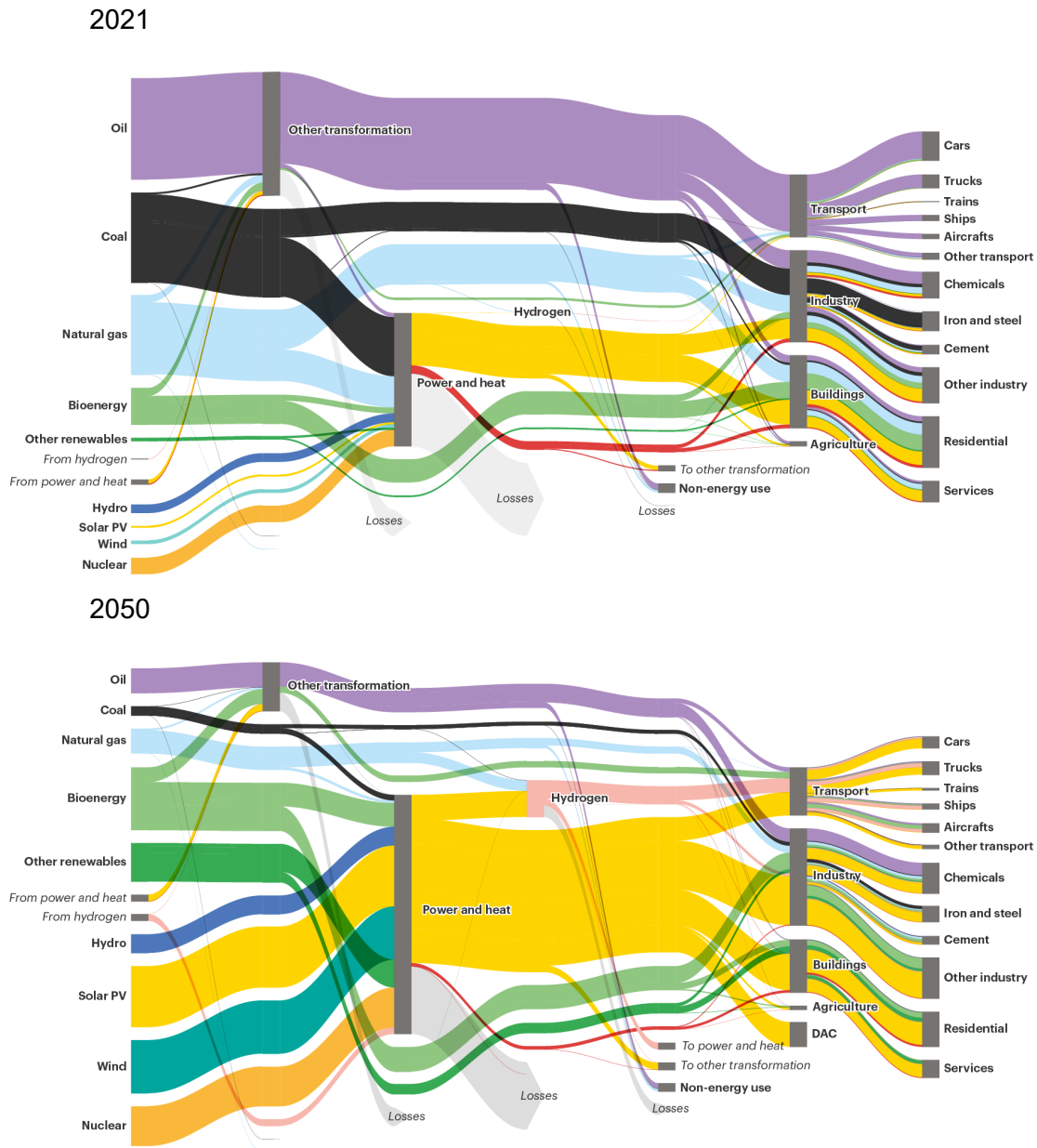

IEA. CC BY 4.0.

Notes: Some electricity is used to generate hydrogen from water electrolysis, while some hydrogen (and hydrogen-based fuels such as ammonia) is in turn used for power generation in 2050. Losses include fuel, heat and power distribution losses, as well as transformation process conversion losses and own use.

Electricity becomes the largest energy vector in the NZE Scenario, with demand more than doubling between 2021 and 2050.

Announced pledges fall short of net zero, but still require major shifts in the energy sector

Despite strong progress, current pledges by governments and companies as reflected in the Announced Pledges Scenario (APS) are not enough to put the world on track to achieve net zero emissions by 2050. In 2050, energy-related CO₂

emissions in the APS amount to about 11 Gt CO₂. Nevertheless, achieving those pledges will still require quick decarbonisation this decade. Emissions fall by about 15% over 2021-2030 in the APS (40% in the NZE Scenario), which calls for major shifts in the energy sector.

In the APS, renewables overtake coal and account for over a fifth of total primary energy supply in 2030, while the share of fossil fuels drops from 80% today to 70% (Figure 1.4). Electrification accelerates – 25% of total final consumption in 2030 – and the carbon intensity of power simultaneously drops by about 40%. Growth decorrelates from emissions, and the energy intensity of the global economy falls by a quarter over 2021-2030. Clean energy technologies are deployed quickly: in 2030, sales of electric cars exceed 40 million (up from 10 million today), 320 GW_{th} of heat pumps are installed (up from 100 GW_{th}), and 30 Mt of low-emission hydrogen are produced (up from less than one).

Figure 1.4 Total primary energy supply, electrification rates and energy intensity in 2030 in the APS and NZE Scenario

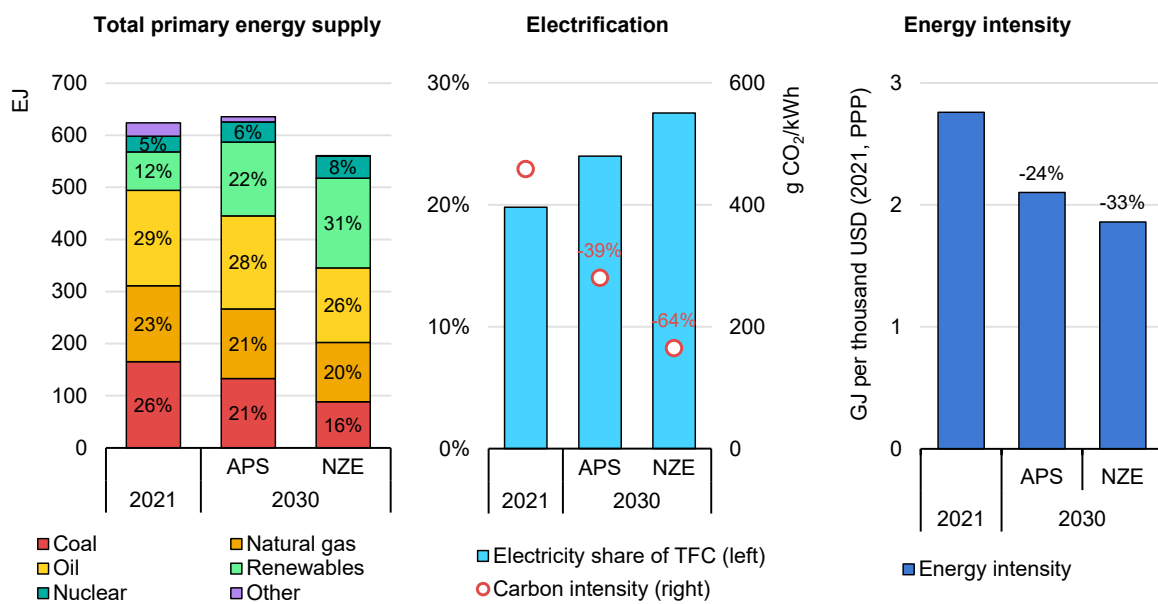

IEA. CC BY 4.0.

Note: TFC = total final consumption; PPP = purchasing power parity. NZE = Net Zero Emissions by 2050 Scenario. APS = Announced Pledges Scenario. In the middle graph on electrification, carbon intensity labels (%) refer to the decrease in electricity carbon intensity in APS and NZE in 2030 relative to 2021. In the right-hand side graph on energy intensity, labels (%) refer to the decrease in energy intensity in APS and NZE in 2030 relative to 2021.

While current pledges as reflected in the APS fall short of net zero pathways, they still require major transformation of the energy sector.

Massive deployment of clean energy technologies is needed

The decarbonisation of the energy system envisioned in the NZE Scenario rests on eight main pillars: behavioural change and avoided demand, energy efficiency, hydrogen, electrification, bioenergy, wind and solar, CCUS, and other fuel shifts

(e.g. switching from coal and oil to natural gas, nuclear, hydropower, geothermal, concentrating solar power and marine energy). Behavioural change and energy efficiency gains do not require fundamental changes to existing energy systems, but the other pillars, which account for over 70% of total cumulative emissions reductions over 2021-2050, require the massive deployment of new types of equipment and infrastructure.

For the purpose of *ETP-2023*, we select key energy technologies and enabling infrastructure across the major decarbonisation pillars from the NZE Scenario to assess and illustrate the implications for supply chains of the clean energy transition (Figure 1.5). Taken together, they account for nearly 50% of total cumulative emissions reductions over 2021-50. Some selected energy and technology supply chains are specific to a particular pillar, such as electric cars and heat pumps for electrification, fuel cell trucks for hydrogen, or solar PV and wind. Some are more cross-cutting in nature, such as low-emission hydrogen and low-emission synthetic hydrocarbon fuels.

Figure 1.5 Global cumulative energy sector CO₂ emissions reductions by decarbonisation pillar and clean energy and technology supply chains studied in *ETP-2023*, 2021-2050

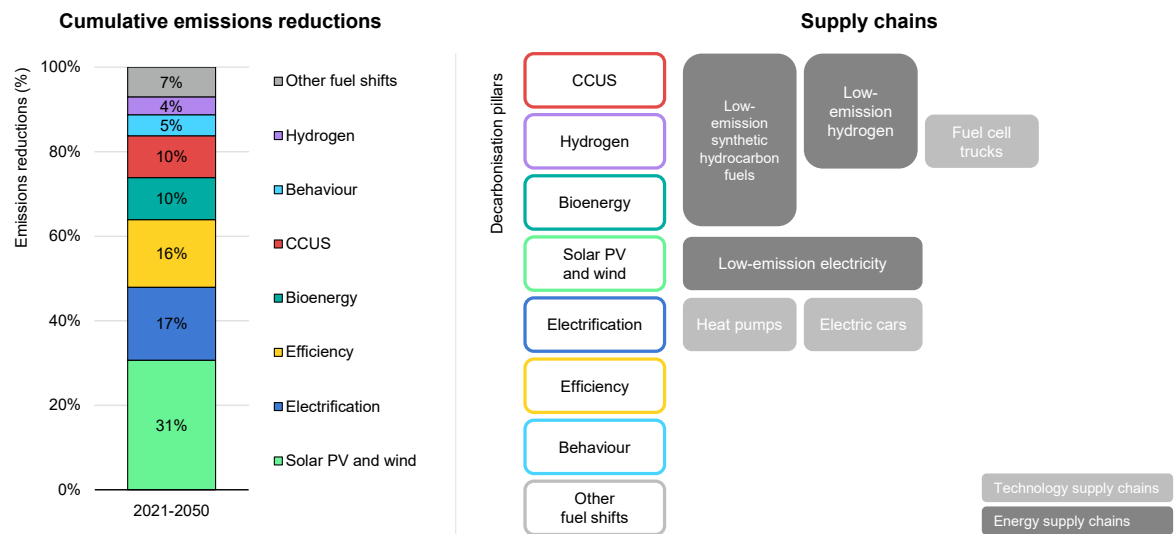

IEA. CC BY 4.0.

Notes: “Other fuel shifts” include other renewables, nuclear, and switching from coal and oil to natural gas. “Behaviour” includes energy service demand changes from user decisions (e.g. changing heating temperature), as well as avoided demand, which refers to energy service demand changes from technology developments (e.g. digitalisation). The technologies featured in the right-hand side diagram are those selected for study in *ETP-2023*.

Six clean energy and technology supply chains hold the potential to unlock around 50% of cumulative emissions reductions to 2050 in the NZE Scenario.

The scale and speed of the required deployment of clean energy technologies needs to increase dramatically to meet the needs of the NZE Scenario (Figure 1.6). Global production of electric vehicles (EVs) (excluding two- and

three-wheelers) increases 15-fold to 2050, while the deployment of renewables nearly quadruples. Low-emission synthetic hydrocarbon fuels (primarily jet kerosene), production of which is minimal today as most technologies are still under development, reach 2.4 billion litres in 2030 (more than the oil consumption of domestic aviation in Japan in 2021) and over 105 billion litres by 2050 (equivalent to the total oil consumption of domestic and international aviation in the United States and the European Union combined in 2021). Production of low-emission hydrogen from electrolysis or natural gas-based hydrogen with carbon capture and storage (CCS) jumps from around 0.5 Mt in 2021 to 450 Mt in 2050 – equal in energy equivalent terms to about half of the world’s energy consumption in the transport sector in 2021.

In many cases, available clean energy technologies on the market today are not yet competitive with existing fossil fuel-based ones, despite recent cost reductions. The former are generally more capital-intensive, i.e. the upfront cost of purchasing or installing them is higher per unit of capacity as they tend to involve more extensive and costly inputs, though their running and maintenance costs are typically lower. For some technologies, higher upfront costs are outweighed by savings during use, though this varies by region. In general, costs in real terms are expected to continue to decline over time as deployment increases and with innovation.

EVs are a case in point. The price gap between electric and internal combustion engine (ICE) cars has been shrinking, thanks mainly to major reductions in the cost of making batteries, helping to stimulate EV demand. Improvements in performance and recent fuel price hikes are also boosting their attractiveness. Yet electric cars remain more expensive and offer shorter driving ranges in most cases. For a medium-sized car, a battery EV typically costs around USD 10 000 (or roughly 40%) more than a conventional alternative (before taxes and subsidies). The price premium is generally smaller in China, averaging about 10%, due to smaller vehicle size and greater competition among carmakers, while it has been rising recently in Europe following large investments aimed at improving vehicle performance.

Heat pumps – a technology that efficiently provides heating and cooling to buildings and industry – also have an upfront price premium when compared with fossil fuel heating equipment, though heat pumps pay back over their lifetime in many regions today. The total cost of purchasing and installing a heat pump ranges from USD 1 500 to USD 10 000 for most homes, but varies substantially depending on the region and the type of unit installed (Figure 1.7). Installation can add substantially to total cost; especially if the energy distribution system needs to be upgraded to accommodate heat pumps (i.e. enlarging radiators or underfloor exchangers), this can add cost. This matters substantially for more efficient ground-source heat pumps, where installation can take up to several weeks and

requires drilling and underground piping, making their total cost much higher than other options. Installation time and costs could decline as heat pumps become more common, and offer greater opportunities than in manufacturing. The most expensive components in heat pumps (e.g. heat exchangers, compressors) have already been mass manufactured for a long time, making further manufacturing cost reductions more limited than for other clean energy technologies.

Figure 1.6 Global deployment of selected clean energy technologies in the NZE Scenario

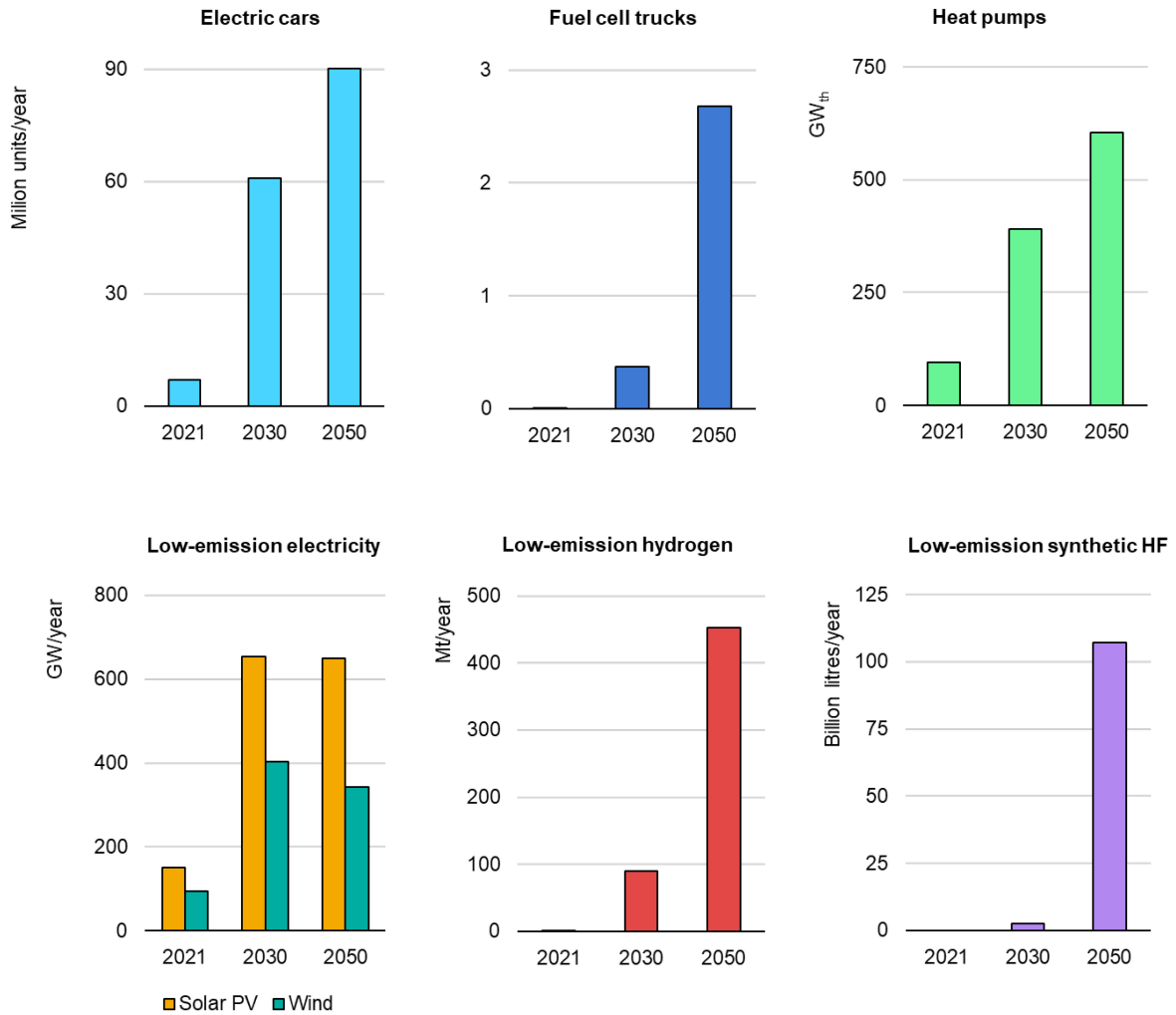

IEA. CC BY 4.0.

Notes: HF = hydrocarbon fuels

The scale and speed of deployment of clean energy technologies and their associated supply chains accelerate dramatically in the NZE Scenario.

Figure 1.7 Heat pumps and heating distribution system market price and installation time for a typical household by type of equipment, 2021

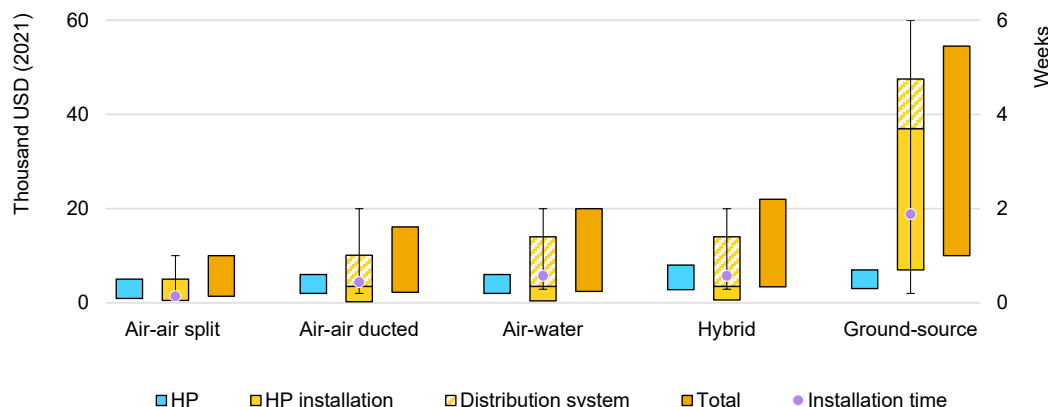

IEA. CC BY 4.0.

Notes: HP = heat pumps. For ground-source heat pumps, the installation costs include drilling costs and underground pipes. HP installation cost includes labour and balance of plant. Distribution system costs include labour and materials. The uncertainty line refers to installation time.

The market price of heat pumps significantly depends on installation costs, where the biggest potential for lowering costs lies.

Many supply-side clean energy technologies also involve higher capital costs than their fossil fuel equivalents. The main exception is solar PV, which is already cheaper in most locations, not accounting for the additional costs associated with its intermittency and variability. The capital cost of solar PV currently ranges from USD 600 per kilowatt to USD 1 000/kW depending on the region, and up to USD 1 800/kW including battery storage. By comparison, the cost of a conventional coal-fired power plant varies between USD 600/kW and USD 2 100/kW depending on the efficiency of the plant and flue gas treatment as well as the region. Equipping the plant with CCUS can push the cost up to between USD 1 800/kW and USD 6 600/kW.

Hydrogen capital costs are also very high. The cost of a conventional natural gas reformer plant sits at USD 780 per kW of hydrogen output (USD 1 470 per kW of hydrogen output if equipped with CCUS), while the capital cost for an installed electrolyser ranges from USD 1 400 per kilowatt electrical (kW_e) to USD 1 770/kW_e (USD 2 150-2 720 per kW of hydrogen output). Capital cost is an important cost component for hydrogen production cost, especially in the case of electrolysers. Natural gas prices affect the economics of producing hydrogen from natural gas reforming, with or without CCUS, making the electrolysis a cheaper production route when gas prices are high (see Chapter 2). At the prices of USD 25 per million British thermal units to USD 45/MBtu that prevailed in Europe during 2022, hydrogen production costs were USD 4.8/kg to USD 8.6/kg, almost 80% of which was due to the fuel cost. In the same region, hydrogen produced with renewables can cost as low as USD 4/kg (IEA, 2022i).

Getting to net zero is not possible without more innovation

Many of the clean energy technologies required to get to net zero by mid-century are not available at scale today. While the emissions reductions to 2030 in the NZE Scenario can be achieved with existing technologies, about half of the emissions reductions in 2050 come from technologies at prototype or demonstration stages today. This includes key technologies, such as cement, steel and aluminium production with CCUS; hydrogen-based steel making; and DAC.

Bringing new technologies and solutions to market takes time. Experience shows that the innovation process usually takes 20 to 70 years from prototype to commercialisation, with large-scale process technologies taking typically longer than small modular technologies (Figure 1.8). The NZE Scenario requires a shortening of innovation cycles, which can be partially achieved by improving the commercial advantage of clean energy technologies. There are several promising projects seeking to address pressing innovation gaps in a broad range of technology areas, but they need to progress quickly to play a major role in the next three decades. Global co-operation and international knowledge transfer, as well as tracking progress, such as in the ETP Clean Energy Technology Guide and the IEA Clean Energy Demonstration Projects Database, will be vital in this regard (IEA, 2022h; IEA, 2022j).

Figure 1.8 Time frame for prototype to market introduction and early adoption for selected clean energy technologies in the past and the NZE Scenario

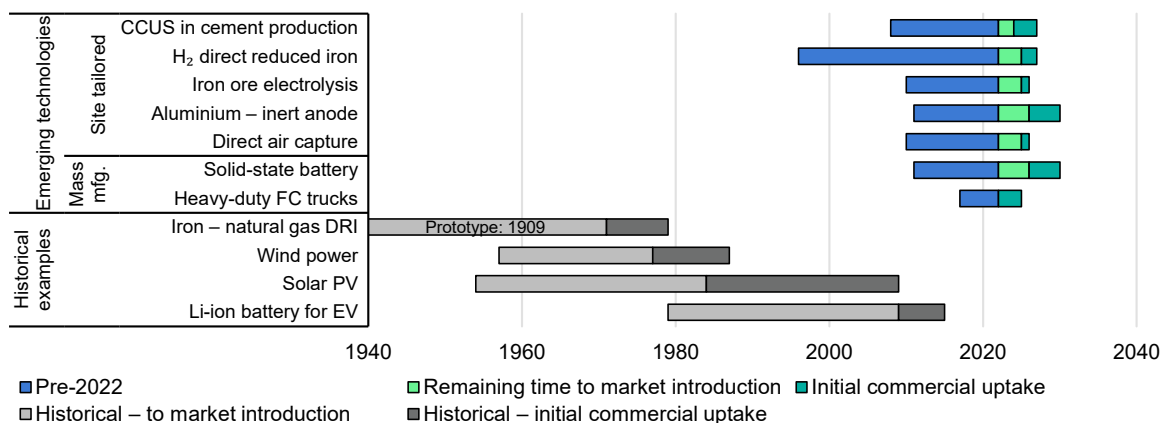

IEA. CC BY 4.0.

Notes: mfg. = manufacturing; DRI = direct reduced iron; H₂ = hydrogen; FC = fuel cell; Li-ion = lithium-ion. Initial commercial uptake is defined as the time until take-up in 1% of the market and market introduction as when the first commercial model is available on the market. Direct air capture is assumed to reach initial commercial scale at 1 Mt of CO₂ per year and market introduction at 1% of the market. Historical figures are calculated for selected market-leading countries (Norway for Li-ion batteries; Germany for solar PV; Denmark for wind power; and the United States for natural gas DRI). Sources: IEA analysis based on Gross et al. (2018); Worldsteel Association (2020); Comin & Hohjin (2004). Also see IEA (2020a).

The time to bring emerging clean technologies to market is generally shorter in the NZE Scenario than was the case for existing technologies.

Implications of net zero for supply chains

Expanding existing chains and setting up new ones

The transition to clean energy hinges on supply chains

Achieving net zero would have far-reaching implications for the supply chains of both clean energy and fossil fuels, with profound changes to the current energy system. Existing supply chains would need to be expanded and modified, while new ones for emerging technologies would need to be created. The clean energy transition is already triggering shifts in global supply chains delivering energy technologies, including mining, material production, technology manufacturing, energy transmission and distribution systems, and other enabling infrastructure. It is helping to cut reliance on fossil fuels and the need to invest in their associated supply chains, but it is increasing the need to put in place new supply chains for manufacturing clean energy technology equipment; produce and deliver clean fuels; and expand, upgrade and develop new electricity transmission and distribution systems that can handle flexibly changing loads and sources of generation.

The energy transition is taking place in a context of globally interconnected supply chains. Most existing technologies are produced and traded around the world. Today, 70% of global trade is in intermediate parts, components and services, the rest being finished goods and services (OECD, 2022a). Manufacturing is spread across many countries, often based on where skills and materials are available at the lowest cost. In many countries, a large share of domestic employment is sustained by trade, ranging from about 10% in the United States to 20% in France and 30% in Germany (OECD, 2022b).

In many emerging and developing economies that are less integrated into today's global energy supply chains, there is considerable potential for establishing new ones that leapfrog fossil-based options. In those with a more established presence in energy supply chains, opportunities are emerging for them to move quickly to develop clean energy alternatives, on the condition that the market power of incumbent suppliers does not constitute a barrier to investment and that incentives for clean energy are high enough.

Critical minerals are changing the energy security paradigm

Until recently, discussions about energy security were largely focused on the supply of fossil fuels, particularly oil. The IEA itself was created in the wake of the 1973-1974 oil crisis. Half a century later, fossil fuels are once again at the heart of an energy crisis, providing a stark reminder of the continuing importance of the

security of supply of traditional fuels on the road to net zero. But energy security in the future will be concerned increasingly with the reliability of clean energy supply chains.

The raw materials, equipment and components involved in clean energy supply chains differ markedly from those needed for fossil fuels. In particular, there is a much greater reliance on a wide variety of critical minerals (Figure 1.9). They include the rare earth elements (REEs) and other metals such as copper, nickel, lithium, cobalt, manganese, graphite, silicon and platinum group elements. The types of mineral resources needed vary by technology. Batteries make use of lithium, cobalt, manganese and nickel. The magnets in some wind turbines and electric engines require REEs. Electricity networks and electric appliances, equipment and EVs require copper. Electrolysers and fuel cells require nickel or platinum group metals, depending on the technology type.

The quantities of critical minerals and other raw materials needed for clean energy technologies can be large. For example, making a 55 kWh battery and associated systems for a small electric car typically requires over 200 kg of critical minerals, including copper, lithium, nickel, manganese, cobalt and graphite, compared with just 35 kg of copper for the powertrain of a comparable ICE. Solar and wind also generally require more steel, aluminium and, in some cases, cement per unit of capacity than fossil fuel-based generating technologies. For example, an onshore wind plant requires nine times more mineral resources than a gas-fired plant with the same capacity.

The deployment of clean energy technologies is already pushing up overall demand for critical minerals. In aggregate, the use of critical minerals solely for those technologies increased by around 20% between 2016 and 2021. In volume terms, copper is the leading critical mineral, accounting for 70% of the total consumption of critical minerals for clean energy in 2021, though the use of lithium and cobalt has increased more in percentage terms since 2016. Demand for minerals in other industrial sectors has also increased in recent years (e.g. lithium and cobalt for batteries in electronics, copper in cars and buildings, nickel in alloys), but it is growing much more quickly in the clean energy sector. While there may be scope to reduce the amount of such minerals and other materials needed through innovation, global demand for them is set to soar as clean energy transitions accelerate.

The increasing reliance on critical minerals is changing the traditional energy security paradigm, which focused on fossil fuel supply, and particularly oil. Setting up secure – that is, reliable and affordable – global supply chains for critical minerals is crucial, not only to accelerate deployment of clean energy technologies to meet net zero, but also to ensure that the future energy system in a net zero world is secure (also see Chapters 2 and 3).

Figure 1.9 Global average raw material requirements for selected energy technologies, 2021

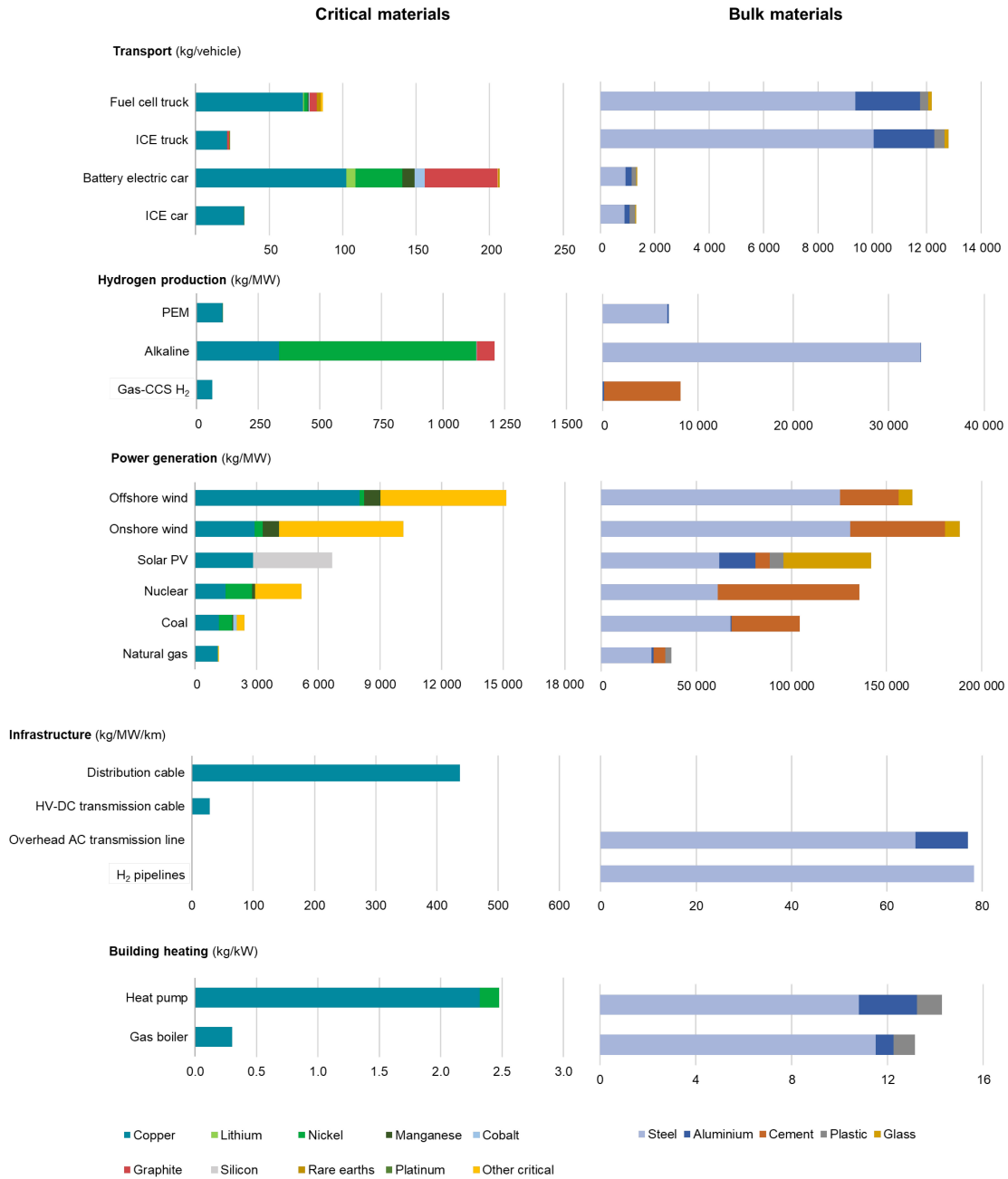

IEA. CC BY 4.0.

Notes: PEM = polymer electrolyte membrane; gas-CCS H₂ = natural gas-based hydrogen production with CCS; HV-DC = high-voltage direct current; AC = alternating current. "Other critical" includes zinc, tin, silver, lead, graphite, boron, chromium and molybdenum. For infrastructure, only copper, steel and aluminium components are taken into account. The steel in overhead transmissions includes the material needs for the conductor and the towers. For EV batteries, the current mix of battery chemistry is used (see IEA [2022e] for more details). The mass of fuel such as oil, coal or uranium is not included.

Sources: IEA analysis based on IEA (2021b); IEA (2022e); IEA (2022k); Greening & Azapagic (2012); Saoud, Harajli, & Manneh (2021); Violante et al. (2022).

The raw materials and equipment involved in clean energy supply chains differ markedly from those for fossil fuels, with much greater reliance on a variety of "critical minerals".

Near-term prospects

The world is not yet on track for secure, resilient and sustainable supply chains

It is far from certain that the global supply chains needed to support the deployment of clean energy technologies projected in the NZE Scenario will be able to expand at the required rates. Moving quickly this decade is vital: any delay means that achieving net zero by mid-century will be out of reach or achievable only at greater cost. This calls for an immediate acceleration in the pace of clean energy deployment and the requisite expansion of their supply chains.

For the purposes of *ETP-2023*, we examine the current status and expansion plans for a number of clean energy and technology supply chains, based on public announcements and industry data, to assess whether they are in line with the trajectories of the NZE Scenario, in terms of the pace of scale-up required, and their level of security, resilience and sustainability. Three metrics are used:

- **Production capacity gap:** We assess whether specific technologies or elements in energy supply chains are on track to reach the required levels of deployment by 2030 in the NZE Scenario. For minerals extraction/mining and material production, we rely primarily on third-party estimates of likely supply availability in the coming years, which are based on projects that are under development/construction or at the late planning stage and are expected to be online before the end of the decade. For technology manufacturing, we rely on both third-party and in-house assessments of announced future production capacity plans.⁶ The supply gap – defined as the difference between what is required in the NZE Scenario by 2030 and what is currently announced, as a share of the former – is used as a proxy for the additional efforts needed. We also calculate the investment needed to fill each of these gaps.
- **Geographical and corporate concentration (see also Chapter 2 for further analysis):** The energy supply chains required in the NZE Scenario need to be secure and resilient to ensure a smooth transition and functioning of global energy systems. If a given step of the supply chain is heavily concentrated in one region or among a small number of companies, the risk of a supply disruption is likely to be greater. We assessed, therefore, whether announced investment plans imply a more concentrated or a more diverse supply chain for each of the main technologies.
- **Energy needs and CO₂ emissions (see also Chapter 2):** Not all steps of the supply chains of clean energy technologies are compatible with net zero at present. Mining extraction and processing, material production and technology

⁶ Based on announcements up to November 2022.

manufacturing currently give rise to large CO₂ emissions. The expansion of these supply chains would need to be accompanied by a drastic reduction in their CO₂ footprint. We assess for each step the impact of scaling up production on global energy demand and CO₂ emissions.

The rest of this section provides an overview of the prospects to 2030 for each step of clean energy and technology supply chains based on the three metrics described above. Chapters 3-5 delve more deeply into their implications and provide more details for each step across different regions (Chapter 3 for mineral extraction and material production; Chapter 4 for manufacturing and installation; and Chapter 5 for infrastructure).

Supply gaps vary by technology and supply chain step

For the **extraction of critical minerals**, the gap between projected needs in the NZE Scenario and expected supply in 2030 is above 25% for lithium and nickel, and nearly 20% for copper (Figure 1.10). The gap, at 35%, is largest in percentage terms for lithium, while the shortfall in supply in absolute terms, at 6 Mt, is largest for copper. Overall, the extraction of critical minerals remains heavily concentrated in resource-rich countries in 2030, with cobalt remaining the most concentrated.

For **critical material production**, the supply gap in 2030 is generally similar to that for mining, with some exceptions. At 60%, the gap for nickel sulfate production is much higher than for nickel mining, and the gap for cobalt processing as well, at 40%. In the case of **bulk materials**, demand does not increase significantly in the NZE Scenario, in part thanks to measures to enhance material efficiency, and the supply gap is close to zero as a result. The expected geographic concentration of the production of critical materials by 2030 is just as high as for minerals mining, with China remaining the dominant producer. In the NZE Scenario, geographic concentration of bulk material production decreases gradually, primarily due to decreasing volumes in China and increased output in India, Southeast Asia and Africa. See Chapter 3 for further details on minerals and materials supply gaps and how to overcome them.

The picture for **technology manufacturing** is much more diverse. For a few clean energy technologies, especially those related to solar PV, current announcements concerning manufacturing capacity point to an increase in global capacity that is more than sufficient to meet projected demand in 2030 in the NZE Scenario. For EV battery manufacturing, the supply gap is relatively small. For both technology groups, manufacturing remains highly concentrated in China. The supply gap is significantly higher for electrolysers at about 50%, and up to over 60% for heat pumps and bioenergy with carbon capture (BECC). Expected production capacity is more evenly distributed geographically for electrolysers and heat pumps, but highly concentrated for BECC. See Chapter 4 for further details on technology manufacturing supply gaps and how to overcome them.

Figure 1.10 Global supply gap with the NZE Scenario and geographic concentration by stage and technology based on expansion announcements, 2030

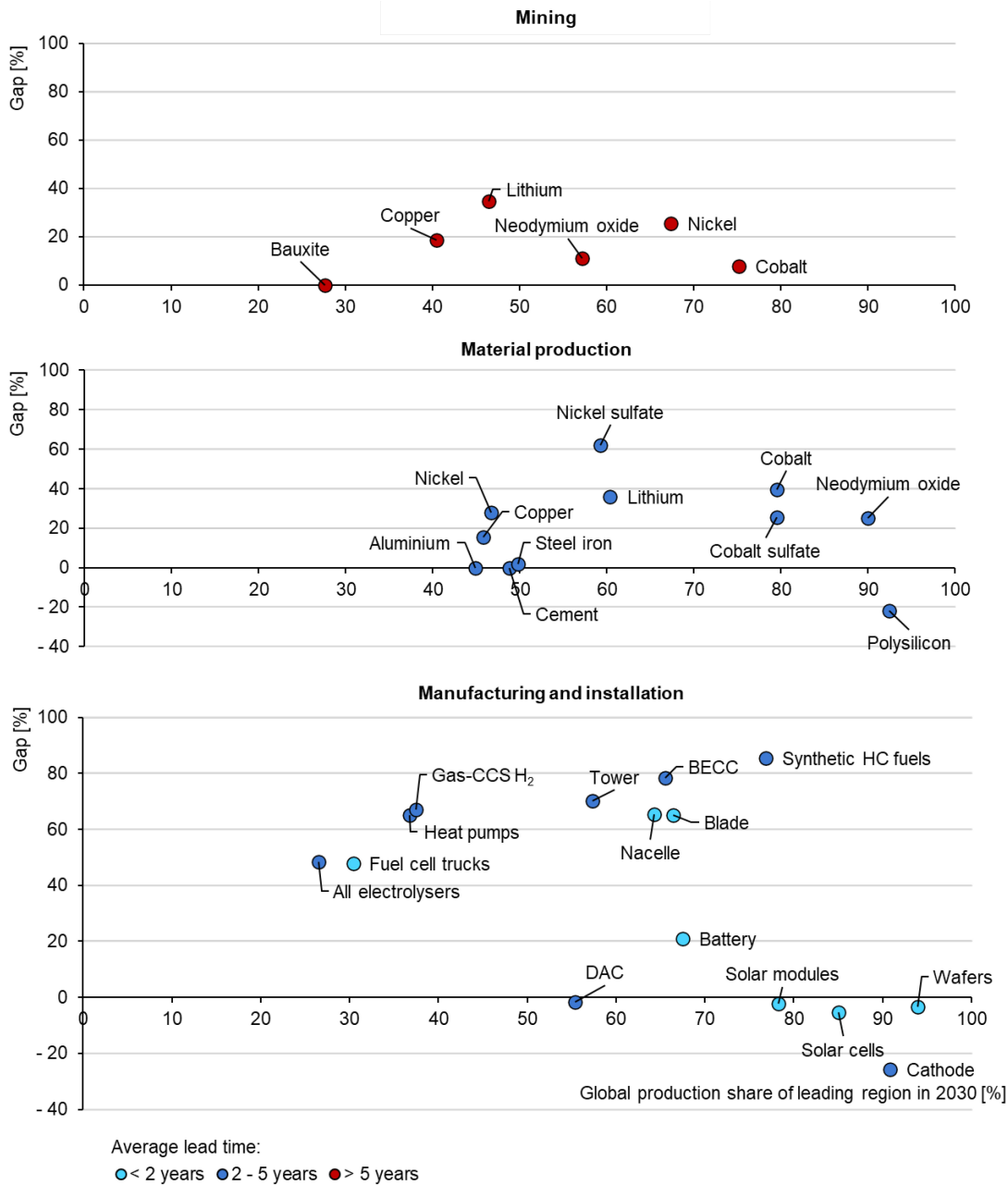

IEA. CC BY 4.0.

Notes: The gap is defined as the difference between required production in the NZE Scenario and projected production taking into account current production and announced expansion plans, expressed as a share of the former. The regions/countries included in this analysis are Africa, Other Asia Pacific, China, Europe, Eurasia, North America, Central and South America, and the Middle East. Gas-CCS H₂ = natural gas-based hydrogen production with carbon capture and storage. Synthetic HC fuels = low-emission synthetic hydrocarbon fuels.

Sources: IEA analysis based on company announcement. IEA (2021b); USGS (2022); S&P Global (2022a); S&P Global (2022b); S&P Global (2022c); S&P Global (2022d); EC (2020); Fraser et al. (2021); InfoLink (2022); BNEF (2022); BNEF (2020). Also see the Annexes to this report.

Current expansion announcements point to large production gaps for some clean energy supply elements, notably lithium mining and nickel processing.

More investments are needed urgently to avoid bottlenecks

Bridging the production gaps described above would require enormous additional investments in the coming years. The total cumulative investment in mining, critical material production and manufacturing of the clean energy technologies selected in this report required to bring the necessary capacity online by 2030 amounts to around USD 1.2 trillion,⁷ in 2021 dollars (Figure 1.11). Investments associated with projects already announced reach around 60% of this, with large gaps in critical mineral mining and for some technology manufacturing.

While mobilising such levels of investment is achievable, the timeline is extremely tight, especially given the long lead times to bring production to market. Most of the investment (including for projects already announced) needs to occur over 2023-2025, implying an average of more than USD 270 billion per year over the period. To compare, this is about two-thirds of current annual capital spending of the oil and gas industry, and nearly seven times higher than the average annual investment seen in clean energy supply chains over 2016-2021.

Figure 1.11 Global investment in selected clean energy supply chains needed to bring online enough capacity in 2030 in the NZE Scenario, by supply chain step

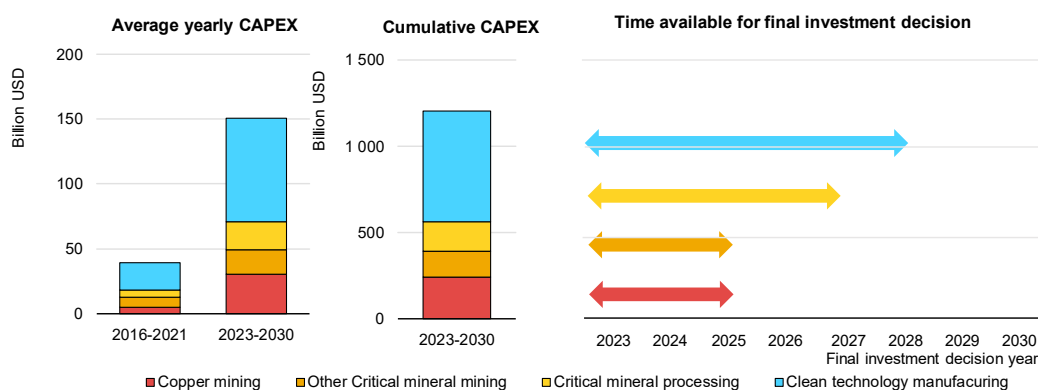

IEA. CC BY 4.0.

Notes: CAPEX = capital expenditures. Only refers to the investments needed to bring online enough capacity in 2030 – not counting what would be needed to further scale up in subsequent years – for the subset of clean energy technologies selected in ETP-2023. Assuming construction times of five years for mining, three for processing plants and two for technology manufacturing. Investments are assumed uniform over the available period. Excludes site-tailored technology installation.

Sources: IEA analysis based on company announcement; Bartholomeusz (2022); S&P Capital (2022).

Most of the supply chain investments needed to meet NZE Scenario targets in 2030 are made over 2023-2025, at an annual average seven times higher than over 2016-2021.

⁷ This refers only to the investments needed to bring enough capacity online in 2030 for the technologies selected in ETP-2023, excluding the investments that would also be needed by 2030 to further scale up deployment in subsequent years.

For the mining of copper, lithium, nickel and cobalt alone, investment of around USD 130 billion per year over 2023-2025 is required, which would be directed to any mining project already in the permitting pipeline. This is equivalent to the entire metal mining industry investments of 2021 (S&P Global, 2022e), implying a doubling of overall investments in the sector in 2023. The copper mining market, which accounts for over half of the required mining investments, may be in part balanced through demand reduction in other sectors and recycling. For the refining of those minerals, announced projects cover about 80% of investment needs for copper, but only over 40% for other metals. In terms of clean technology manufacturing capacity, announced projects cover two-thirds of investment needs to 2030.

The overall investment needed in clean energy supply chains is much higher than the investment required to develop those under study in *ETP-2023* and bring sufficient capacity online by 2030. In total, investment in clean energy technologies and infrastructure reaches over USD 4.5 trillion in 2030 in the NZE Scenario (IEA, 2022f). This scale of investment is unprecedented. Mobilising it across all regions, technologies and supply chains is an enormous task. Bottlenecks can occur as a result of policy and regulatory risks, a lack of confidence in demonstration and first-of-a-kind projects, uncertainty about project pipelines, wider macroeconomic factors such as currency stability, and geopolitical events.

The risk of underinvestment in clean energy and supply bottlenecks is particularly acute in the emerging economies. One hurdle to investment in those countries is their higher cost of capital, which has a significant impact on the financial viability of clean energy projects. For example, financing costs for material production projects can be more than twice that in the advanced economies, due a greater perception of risk (Figure 1.12). Costs in China tend to be lower due to the importance of state-owned enterprises and their ability to raise cheap public finance.

Figure 1.12 Cost of capital for bulk material production industries by country/regional grouping, 2020

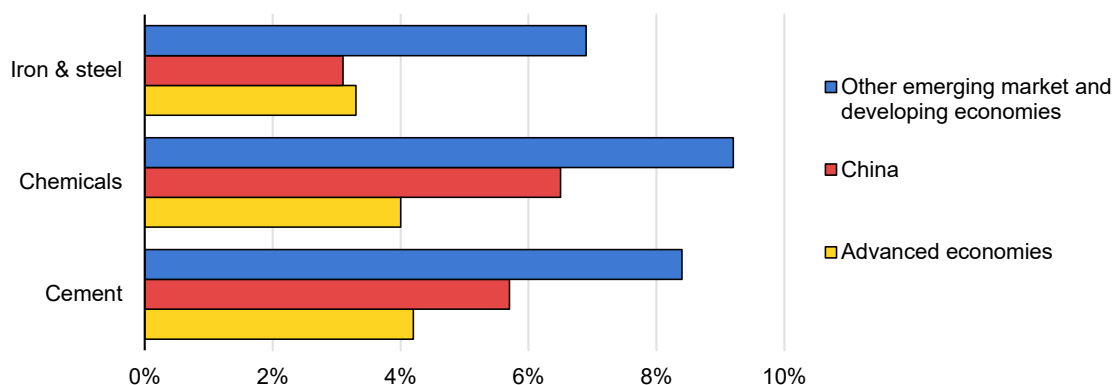

IEA. CC BY 4.0.

Source: Adapted from IEA (2021c).

Financing costs for bulk material production in the emerging economies can be more than twice those in advanced economies, driven by a greater perception of risk.

Each step of the supply chain must be decarbonised

Each step of the supply chain of all types of clean energy and technology is decarbonised in the NZE Scenario, their total associated CO₂ emissions falling by 95% between 2021 and 2050. Manufacturing is almost completely decarbonised by 2050, while there are some residual emissions in bulk material production and mineral processing (offset by negative emissions elsewhere in the energy system). The decarbonisation pathways vary across sectors and supply chain steps. They involve mainly electrification in mining and manufacturing, and the use of low-emission hydrogen and CCUS in material production.

Important progress is made in decarbonising the **mining** of critical minerals over the rest of the current decade in the NZE Scenario. The current energy and CO₂ emissions intensities of mining operations for critical minerals are higher than for more commonly used minerals due to the lower concentration of the minerals in the ores. With rising demand and declining ore grades, global CO₂ emissions from mining critical minerals could double over 2021-2030 to 30 Mt (see Chapter 3). Emissions from **material production**, which are currently the largest of all supply chain steps, decrease quickly in the NZE Scenario, down 40% for cement and 25% for iron and steel over 2021-2030. Emissions from **technology manufacturing** are typically smaller than other steps, and fall steadily mainly thanks to electrification (see Chapter 2).

Decarbonising supply chains would come at a cost, although the impact on final consumers would, in most cases, be marginal. Producing low-emission bulk materials, notably steel, cement and aluminium, results in significant additional costs compared with conventional production routes (Figure 1.13). Cost premiums for low-emission alternatives today vary based on different technology options, with some claiming near cost equivalence (e.g. smelting reduction with CCUS), while others are likely to command a significant premium (e.g. hydrogen direct reduction). Cost estimates warrant further analysis as the first set of plants are built over the 2020s.

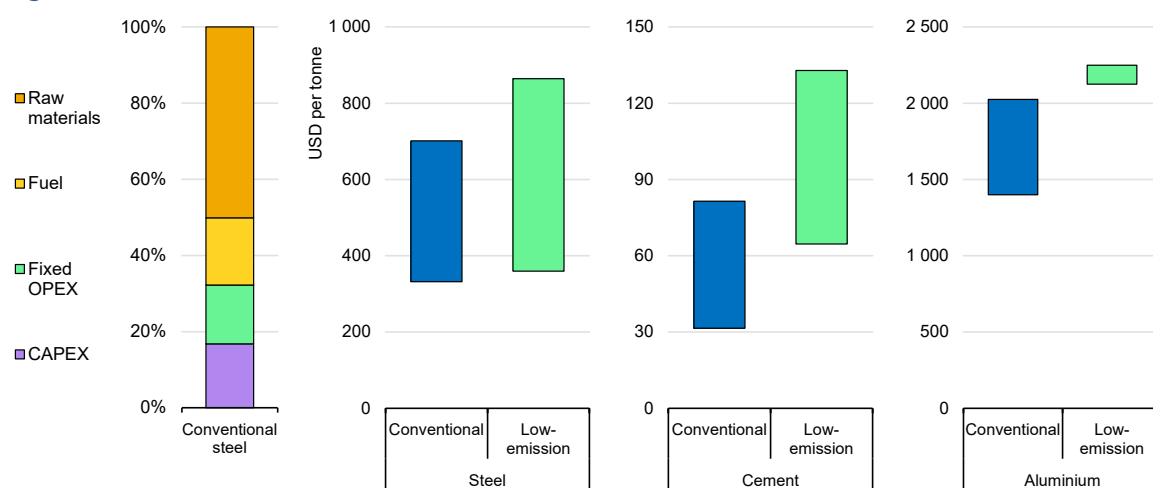
Figure 1.13 Indicative levelised cost of production for selected bulk materials

IEA. CC BY 4.0.

Notes: OPEX = operational expenditures. Levelised cost is a proxy for production costs, calculated as the average net present financial cost of producing a good, accounting for total costs and output over the lifetime of the factory or plant. Estimated costs in a range of typical price contexts since 2019. On the left-hand side for steel, the cost breakdown is for a conventional blast furnace-basic oxygen furnace. The ranges on the right hand side represent different production routes. Low-emission estimates are based on plants that have reached commercial scale.

Sources: IEA analysis based on IEA (2020b); MPP (2022).

Cost premiums of low-emission alternative routes for producing bulk materials vary significantly by material and technology.

Although the cost of producing bulk materials using low-emission technologies is generally significantly higher than using conventional ones, the estimated impact on final prices for clean energy products is typically small, as bulk material costs represent a relatively small share of their total production cost. For example, a 50% increase in the cost of steel at 2021 prices would result in an increase of only around 0.5% in the final average cost of an electric car, 0.2% for a residential heat pump, 1% for an offshore wind farm and 1.5% for utility-scale solar PV. Based on 2021 costs, fully decarbonising production for these bulk materials would push up the cost of making an electric car by 0.7%, a heat pump less than 0.3%, an offshore wind farm by 0.6%, utility-scale solar PV over 2% and a typical house by 1.4% (Figure 1.14).

Manufacturers' ability to pass on cost increases to consumers depends on the magnitude of the increase and on competition with conventional products. For example, vehicle and home heating system markets are particularly competitive, potentially making it more difficult for EV and heat pump manufacturers to pass on cost increases. Producers of wind turbines and solar PV modules are currently better placed to pass on higher costs thanks to surging wholesale power prices in most regions. Nonetheless, some companies or consumers may be willing to pay a premium for clean products. For example, at least ten companies in the automotive sector have committed themselves to using "green steel" from 2025 (H2 Green Steel, 2022; SteelZero, 2022; First Movers Coalition, 2022).

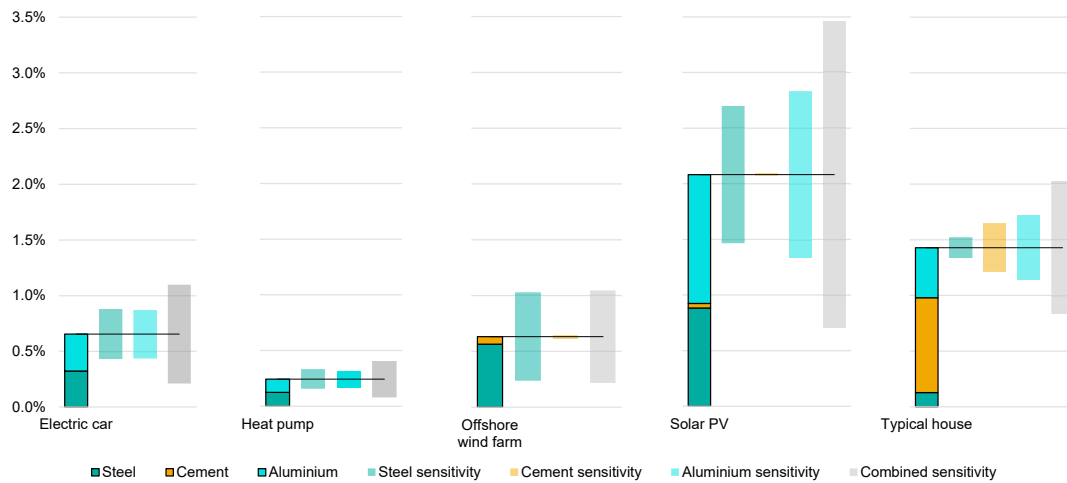
Figure 1.14 Increase in the global average prices of selected clean energy products from switching to low-emission bulk material production

IEA. CC BY 4.0.

Notes: Based on 2021 costs of typical products: USD 36 000 for an electric car; USD 11 000 for a heat pump, USD 2 860/kW for an offshore wind farm, USD 880/kW for solar PV and USD 300 000 for a single-family home. The assumed cost premiums for low-emission materials are 10-50% for steel; 60-110% for cement and 10-50% for aluminium, with these cost ranges informing the sensitivities for each material.

Sources: IEA analysis based on IEA (2020b); MPP (2022).

Decarbonising clean energy supply chains would come at a cost, although the impact on buyers would, in most cases, be marginal.

Supply chain lead times and product durability

Building mines and factories and ramping up output takes time

The time needed to put in place and expand supply chains is a major constraint on how quickly the clean energy transition can be achieved. The industries and infrastructure that underpin the world's existing energy supply chains took decades to develop – fossil and clean technologies alike. Building a new factory, mine, road or pipeline takes time, as does expanding production from existing factories and facilities. In addition to lead times – defined as the time that passes from when a project is announced (i.e. a company states the intent to build a given facility) to when the project begins commercial operation – there are production ramp-up times: once a new production facility is established, some time is needed before the machinery is able to produce at its full nominal capacity.

Lead times are important as they have an impact on the speed at which supply can react to demand. The inability to expand supply quickly, especially when spare production capacity is tight, can hinder the ability to meet a rapid increase in demand, such as that of solar PV and EVs. The result is bottlenecks in supply and higher prices, as has been the case with semiconductors and EV supply chains since 2020 (see Chapter 2) (IEA, 2022). A failure to anticipate future demand alongside barriers to investment could hinder global decarbonisation efforts and hold back progress towards a clean energy future.

The longer the lead time for a given supply chain component, the greater the risk of underinvestment, co-ordination and sequencing issues with other steps of the supply chain, and future bottlenecks in supply. If projects at a given step of the supply chain are undertaken sequentially, long lead times increase the time between the first and second generations of plants. If projects are carried out in parallel, long lead times may reduce the opportunity to learn from each other. Long lead times also increase investment risk and, therefore, the cost of capital, components and final products: investing in a project that is due to start generating revenues within a year is inherently less risky and easier to finance than one starting to pay back in several years. Long lead times also imply greater exposure to regulatory, political and market changes.

Some of the longest lead times in clean energy supply chains are in the upstream, i.e. mining of raw minerals (Figure 1.15). In some cases, the entire process can take more than two decades. This comprises the time needed for exploration (to identify an economically extractable resource) and construction (building the mine and starting commercial operation). Exploration often takes a long time (usually more than a decade) and does not always result in a development project. The fastest mining operations have a lead time of under five years, but ramping up production to full capacity typically takes almost as much time. For established mining techniques, ramping up production can take up to three to four years. In cases where more complex operations are involved, ramp-up times can be much longer. For example, most high-pressure acid leaching nickel production projects in Indonesia have required five years to reach nominal production (IEA, 2021b).

Figure 1.15 Lead times for mining of selected minerals

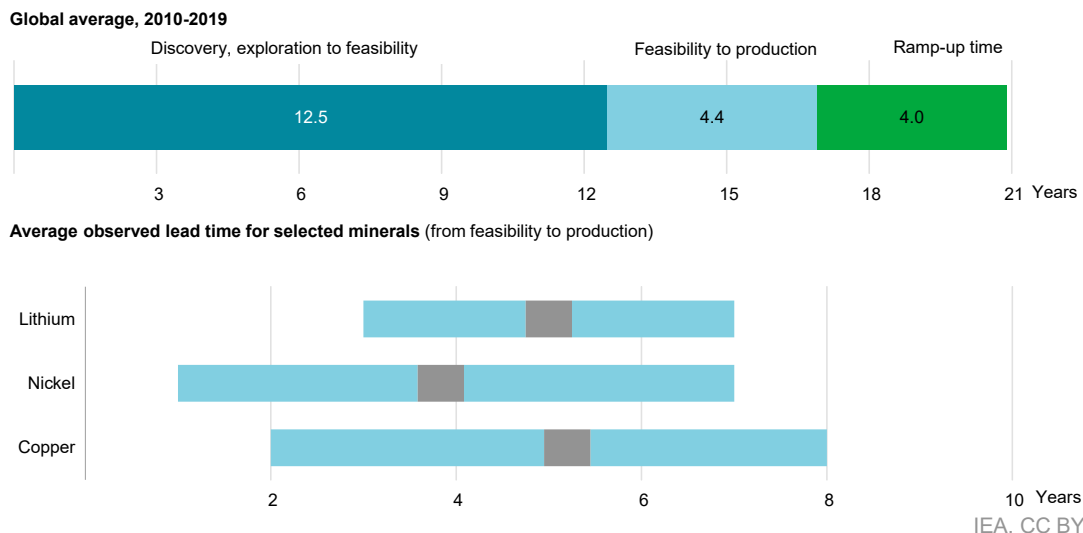

Note: Lead time averages are based on the top 35 mining projects that came online between 2010 and 2019. Sources: IEA analysis based on S&P Global (2020); S&P Global (2019); Fraser et al. (2021); Heijlen et al. (2021). IEA. CC BY 4.0.

Exploration takes the most time in bringing new mines into operation, while construction and ramping up production to full capacity typically take almost a decade.

There are several reasons for these long lead times. Exploration and resource appraisal carry substantial risk, making it difficult for mining companies to obtain financing from lenders. As a result, they often use their own cash flows to pay for investment. Financing mining operations can also be difficult, largely because of uncertainty about future market demand and commodity prices – especially if supply chains are nascent. The financial structure of mining projects is usually a highly leveraged mix of debt and equity, with the goal of generating as much cash and as little balance sheet profit as possible.

Mine engineering and construction also take time due to their large scale and complexity, as well as the need to make use of other infrastructure such as ports, roads and power plants before operations can start. Large amounts of earth and rock need to be displaced before reaching the ore-containing layers. Permitting is also a very time-consuming step, primarily because of the importance of carrying out rigorous impact and environmental assessments and legal procedures, and ensuring local community acceptance and equity. This is particularly true of heavily contested projects such as those in areas with indigenous populations or of significant environmental concern.

Material production projects generally take less time to complete than mining projects, but can still take several years. Like other heavy industrial projects, time is needed to procure the necessary machinery and to obtain the required environmental permits to build and operate plants.

Commissioning manufacturing facilities for components used in making clean energy products can take up to five years (Figure 1.16). In addition to the construction work, additional time is needed to hone the manufacturing process, which can take up to a year depending on the complexity of the process and the company's experience. For example, building a completely new polysilicon factory can take 12 to 42 months and ramping up production another 6 months, while building new production lines for wafers, cells and modules at existing factories can take as little as 4 months, once the go-ahead has been given.

Factories to assemble final clean energy technologies can generally be built relatively quickly. For EVs, the excess production capacity of existing automotive factories means that it is often sufficient to retool an existing factory to be able to ramp up production in the near term. Vehicle assembly technology is mature and there are a lot of machinery suppliers available, so raising capacity can be very quick. Similarly, for PV module assembly, standard machinery is often used, resulting in relatively short lead times. For both component manufacturing and final assembly, ramp-up times can be similar to construction times. For example, construction of Tesla's first gigafactory in Nevada in the United States started in 2014 and came online in 2017, but reached its nominal capacity of 35 GWh only in 2021.

Building and expanding enabling infrastructure such as pipelines, CO₂ storage facilities and electricity grids also involve long lead times, in some cases over a decade (Figure 1.16). These projects have similar characteristics to mining projects, including their large scale, high capital requirements and vast land coverage, sometimes across different jurisdictions. As a result, they face similar obstacles, including permitting and approval processes, financing, and public acceptance. Limited availability of specialist equipment and skills can also cause bottlenecks, particularly for offshore projects.

Developing supply chains for emerging clean energy technologies as they become available are unsurprisingly likely to take much longer than for existing ones. Many of the technologies needed in the NZE Scenario, including DAC, low-emission synthetic hydrocarbon fuels and some low-emission technologies in heavy industry, are still at the prototype or demonstration stages today and are not yet commercially available at scale. They first need to be demonstrated in real operating conditions, probably requiring several “first-of-a-kind” facilities at different sizes or in different regions, before they can be deployed successfully on a commercial scale. In parallel, fully fledged supply chains would need to be established and expanded progressively. Permitting is likely to take more time for plants that make use of novel technologies.

For small, modular or standardised technologies such as solar PV, batteries, heat pumps and fuel cells, lead times are generally much shorter than for large, more complex or specialised technologies such as those used in biorefineries, BECC and CCUS facilities, advanced nuclear reactors, and mines. This is especially true when technology designs depend on the specific use to which it is put and when it is linked to existing facilities, such as retrofitting CCUS to an existing power plant, which can increase the time needed for testing to make sure the impact on the operations of the existing plant is minimised. For complex and novel technologies, shortages of skilled labour can lengthen lead times and require extra planning. For example, biorefinery shutdowns for upgrades can be planned together with other refineries in the region to optimise the use of scarce labour.

Figure 1.16 Range of (top) and average (bottom) global lead times for selected clean energy technology supply chains

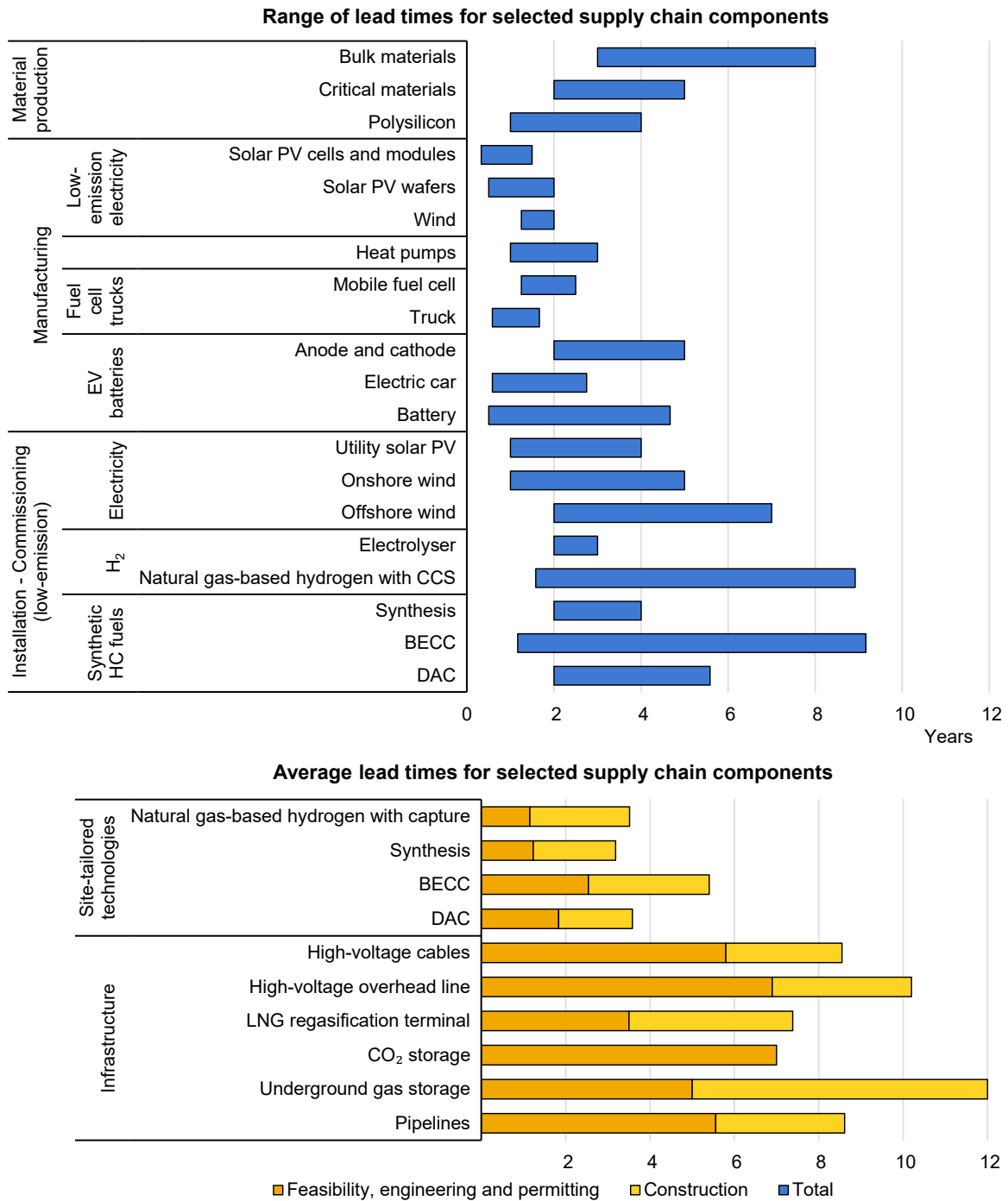

IEA. CC BY 4.0.

Notes: Construction for CO₂ storage often occurs during detailed engineering and ahead of permitting since wells are usually drilled during site characterisation to acquire the data needed for permitting. As a result, construction time has been combined with feasibility, detailed engineering, and permitting. LNG = Liquefied natural gas.

Sources: IEA analysis based on company announcements; IEA (2021b); IEA (2022m); United Kingdom, Department for Business, Energy & Industrial Strategy (2020); IEA (2022e).

Some of the longest lead times in clean energy supply chains are in material production and enabling infrastructure, such as power transmission or CO₂ management.

Accelerating deployment calls for shorter lead times

Shorter lead times would help facilitate an acceleration in the deployment of clean energy technologies. For minerals extraction, lead times to open new mines and expand existing ones are reduced substantially in the NZE Scenario, including a cut in permitting times to just one year – the minimum time required to prepare a thorough environmental assessment and ensure adequate safeguards. In addition, policy support, the prospect of long-term demand growth and high mineral prices can give more confidence to investors, shortening the period needed to secure financing for mining projects.

There are several historical examples of the rapid deployment of new technologies, notably modular and mass-manufactured technologies, being achieved by compressing lead times, which suggest that the rapid rates of deployment of clean energy technologies in the NZE Scenario are achievable in a similar way. For example, the urgent production of aircraft during World War II and the recent launch of Covid-19 vaccine manufacturing involved compressing lead times drastically, in both cases to less than one year compared with several years previously (Figure 1.17). Their success was due in part to relatively mature processes for developing the products and building factories, as well as the critical circumstances, which ensured massive demand directly from governments and enabled them to appropriate swathes of existing industrial capacity for emergency retrofitting and reuse. For certain mass manufactured clean energy technologies such as EVs, global deployment is still growing rapidly, approaching the rates required in the NZE Scenario, implying that lead times should not be a cause of supply bottlenecks.

For technologies and projects with inherently longer lead times, such as mining projects and nuclear power plants, there are also historic examples suggesting industry could sustain fast growth rates. In the 2000s, iron ore mining grew at a 10% annual rate, an expansion which was mainly driven by surging demand in China and a tenfold increase in iron ore prices between 2000 and 2010 (IMF, 2022). In the NZE Scenario, lithium mining expands much more quickly at an annual rate of 25% over 2021-2030, after which growth slows down and peak production is reached in 2040. Basic oxygen furnaces were deployed very quickly in the 1960s at an average annual growth rate of over 35%. Once the technology reaches commercial scale by the 2030s in the NZE Scenario, hydrogen-based steel production grows on average by only 17% per year; however, getting the first commercial-scale plants in the late 2020s is the main challenge. For this to happen, producers need a fundamental cost advantage and clear financial incentive to lower lead times and encourage investment and innovation as commercial deployment begins.

Figure 1.17 Global scaling-up of selected energy and other supply chains by lead time in the past (solid) and the NZE Scenario (dashed)

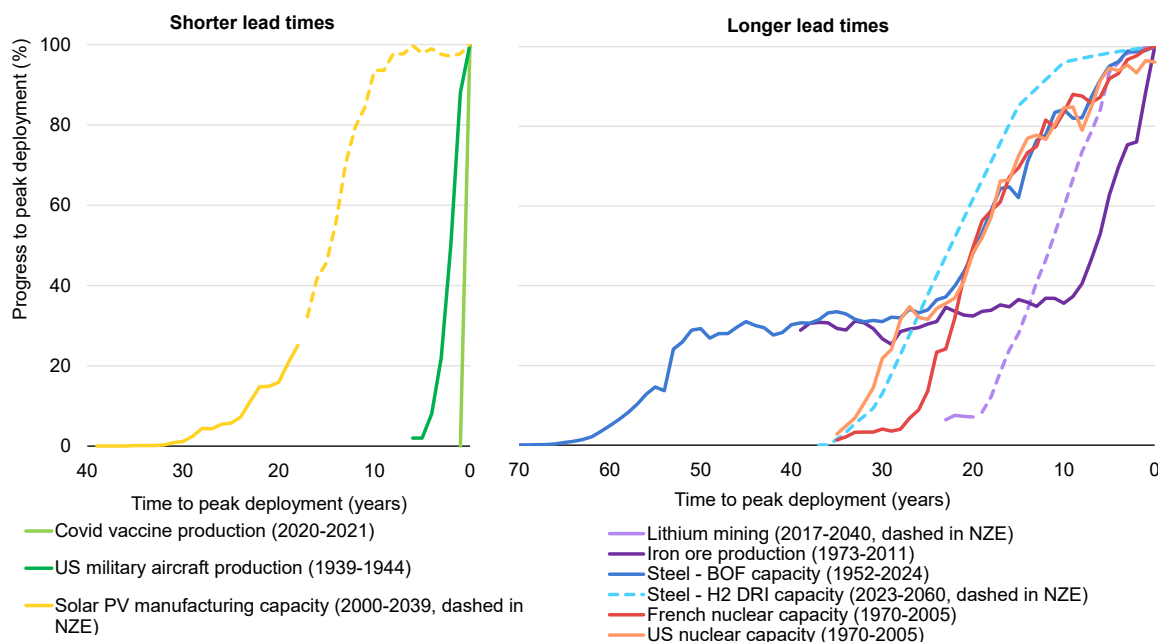

IEA. CC BY 4.0.

Notes: BOF = basic oxygen furnace steel making; H₂ DRI = hydrogen direct reduction based steel making; NZE = Net Zero Emissions by 2050 Scenario. Historic solar PV manufacturing capacity uses additions to world’s grids as a proxy for manufacturing capacity. Data are global averages except for US military aircraft production and French and US nuclear capacity. US nuclear capacity is plotted for the same time period as French nuclear capacity, though the historic peak was in 2019, as US nuclear capacity saw little variation between 2005 and 2019.

Sources: IEA analysis based on USGS (2022); Comin & Hohjin (2004); Richter (2022).

Historic examples suggest that rapid deployment of clean energy by compressing lead times is technically possible, especially modular and mass-manufactured technologies.

Shortening lead times should not be taken for granted: there are several examples of lead times for energy projects increasing, which serve as a cautionary tale. The rapid slowdown in the rate of growth in nuclear power generation in France, from around 85 TWh per year over 1978-1986 to around 15 TWh per year over 1990-2005, was in part due to a substantial increase in lead times from about five years in 1980 to ten years in 2000 (Berthélemy & Rangel, 2013).

Clean energy technologies need to be made more durable

Differences in the durability of clean energy technologies relative to conventional fossil fuel ones have important implications for both their competitiveness and sustainability. For example, the operational performance of renewables such as solar PV and wind can drop after a decade, with most having a lifetime of around 25-years. In contrast, coal- and gas-fired power plants can operate for 30 to 40 years or more, though intermittent large-scale refurbishment may be needed (Figure 1.18). Some ICE cars can be used for several decades, especially second-hand ones that are sold to emerging economies at low prices, while EV batteries

tend to degrade by up to 30% after 8 years and are typically retired within 15 years (UNECE, 2022). Technological advances are likely to improve battery durability, such that EVs could ultimately match the durability of ICE vehicles as they are based on simpler transmissions and powertrains. Regular maintenance and end-of-life management play a considerable role in ensuring the sustainability of clean technologies.

In some cases, clean energy technologies can already be more durable than their more carbon-intensive alternatives. One example is LED technologies for lighting, which last much longer than tungsten-filament light sources and compact fluorescent lamps. Recycling and refurbishing obsolete equipment can greatly reduce the energy and emissions intensity of clean technology supply chains.

Figure 1.18 Typical operating lifetime of selected energy technologies

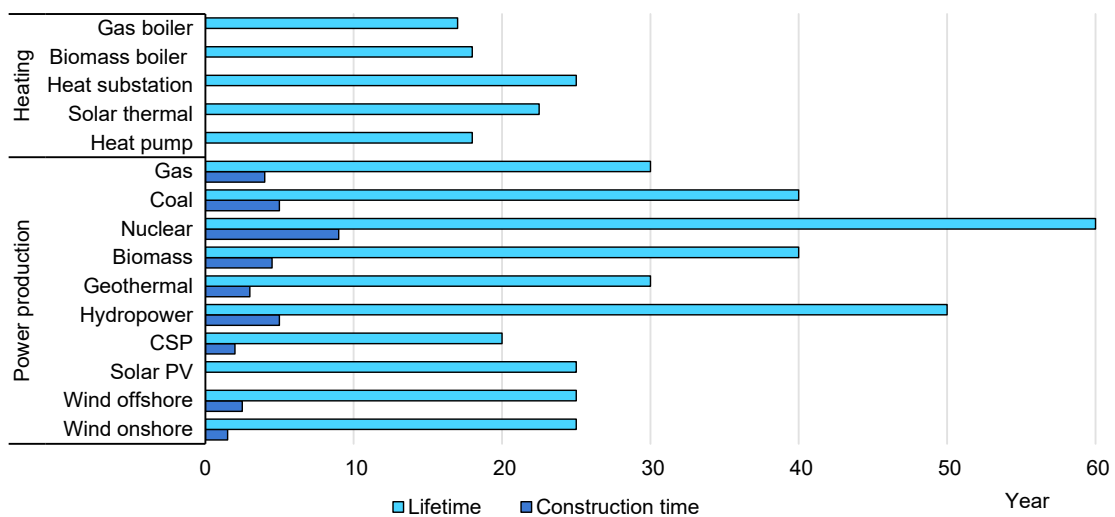

IEA. CC BY 4.0.

Notes: CSP = concentrating solar power. Biomass in power production refers to dedicated biomass; biomass in heating refers to modern biomass. Heat pumps in this example are air-to-water units. Heat substation refers to heat exchangers (district heating).

Source: IEA analysis based on Schlömer et al. (2014).

Some clean energy technologies are less durable than existing fossil fuel ones, increasing the need for recycling and refurbishing obsolete equipment to limit environmental effects.

Employment along clean energy supply chains

Clean energy employment today

Labour markets worldwide have experienced major upheavals since the start of the Covid-19 pandemic, due to the economic disruption caused by restrictions on the movement of people and commercial activity. Energy sector employment has not been immune from these shocks and has also been affected by the recent energy crisis in the wake of Russia’s invasion of Ukraine. While higher energy

prices have, in many cases, boosted the demand for workers in the oil, gas and coal industries, the growing attractiveness of clean energy technologies and their increasing deployment is pushing up demand for workers in those sectors as well. Stronger policy responses to the climate and energy crises are expected to continue to drive a shift in employment away from the fossil energy industries to clean energy sectors in the coming years and decades. Overall energy sector employment is set to grow steadily through 2030 as demand for energy services continues to expand and supply shifts to more labour-intensive activities (Figure 1.19).

Figure 1.19 Global energy sector employment by technology

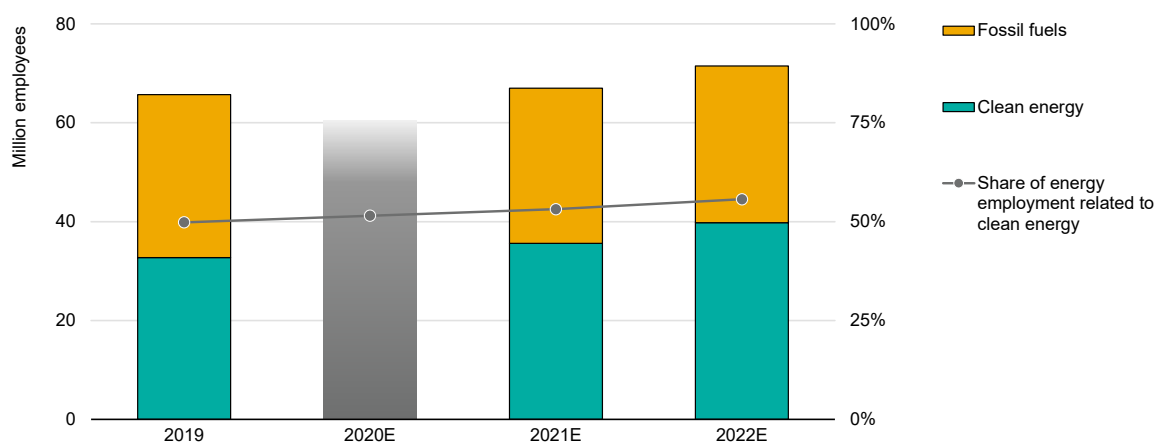

IEA. CC BY 4.0.

Note: Clean energy employment includes workers in bioenergy supply (including farmers), nuclear and renewables for power generation, grids and storage, EV manufacturing, and energy efficiency (such as building retrofits, heat pump manufacturing, and ventilation and air-conditioning installations). Labour market disruptions associated with the Covid-19 pandemic made 2020 employment difficult to assess, so 2020 estimates are indicative. Estimates for 2020-2022 are modelled based on latest IEA energy balances and investment data, under the assumption that labour intensity and the job creation potential of new investment remain constant across years; for more details please refer to the World Energy Employment report methodology.

Sources: IEA analysis based on IEA (2022n).

The total number of jobs in clean energy supply and use, and their share of total energy employment, has grown in recent years despite the Covid-19 pandemic.

Over 65 million people are employed worldwide in the energy sector, including direct jobs in energy supply industries as well as indirect jobs in manufacturing essential components of energy technologies such as the manufacturing of vehicles or heat pumps (Figure 1.19). Around two-thirds of energy workers are engaged in the development of new projects or equipment, while the other third are involved in operating or maintaining existing assets. Energy workers are spread across economic sectors: over 14 million employees work at utilities and firms providing professional services, approximately 22 million in manufacturing of equipment, 16 million in construction of energy facilities, 9 million in the raw materials sector, and 9 million in related activities such as wholesale trade and energy transport.

Overall energy employment is concentrated in countries with major manufacturing hubs and large energy production industries, especially where new energy facilities are being built. As a result, almost three-fifths of all energy employment is in the Asia Pacific region, with China alone accounting for almost 30% of the global energy workforce with nearly 20 million energy workers (Figure 1.20). Clean energy employment now accounts for just over half of the global energy workforce. This is in large part due to the continued growth in new projects, which generate the most jobs (construction and installation activities are highly labour-intensive). Most new energy projects today involve clean energy supply or end-use activities. Eurasia and the Middle East are now the only regions where the share of clean energy employment does not exceed half.

Low-emission power generation currently employs an estimated 7.8 million workers worldwide, with over 4.2 million in solar and wind alone. Fossil fuel-based power generation employs just 3.4 million (Figure 1.21). There are roughly the same number of workers in low-emission power generation as in the oil supply industry, which employs the most people among the three fossil fuel supply sectors. In vehicle manufacturing, 10% of the almost 14 million workers worldwide are already involved in making EVs, their batteries and related components.

Figure 1.20 Energy employment by region and supply chain step, 2019

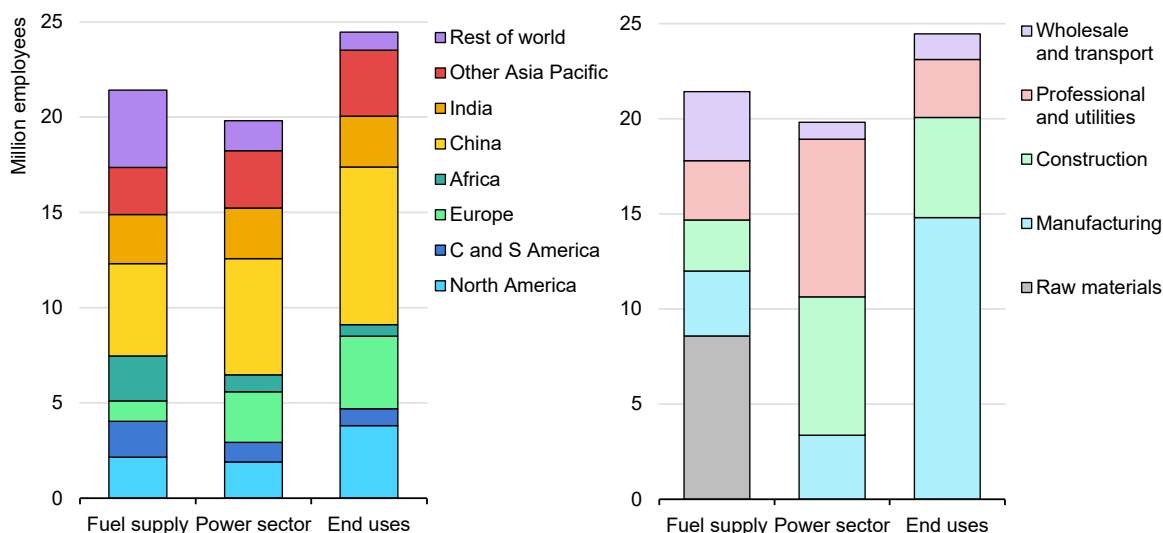

IEA. CC BY 4.0.

Notes: C and S America = Central and South America. Value chain steps and economic sectors for employment are aligned with International Standard Industrial Classification (ISIC) rev.4 (a standard classification of economic activities). "Raw materials" includes agriculture (ISIC code A) for bioenergy production, as well as mining and quarrying (ISIC code B) for fossil fuels (excludes critical minerals mining). "Manufacturing" (ISIC code C) includes both traditional manufacturing and material processing such as the manufacture of refined petroleum products. "Construction" (ISIC code F) indicates installation, while "Professionals and utilities" encompasses the supply of electricity, gas, steam and air conditioning (ISIC code D), as well as professional, scientific and technical activities (ISIC code M). "Wholesale and transport" refers to wholesale and retail trade (ISIC code G), and transportation and storage (ISIC code H). End uses refers to jobs in vehicles manufacturing (including related batteries), energy efficiency for industry, and buildings (retrofits and efficient heating and cooling).

Sources: IEA analysis based on IEA (2022n).

The manufacturing and construction of new projects dominates energy employment today.

Figure 1.21 Energy employment in selected sectors by region, 2019

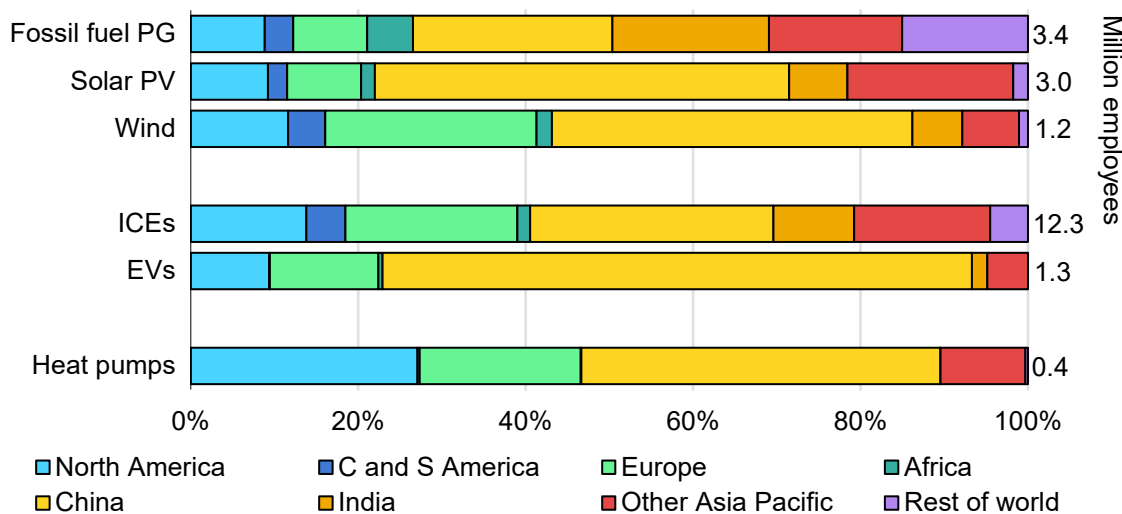

IEA. CC BY 4.0.

Notes: Fossil fuel PG = fossil fuel power generation. EV employment includes manufacturing of EV batteries and other related components.

Sources: IEA analysis based on IEA (2022n).

Low-emission energy technology sectors already employ large numbers of workers, though their share of total energy employment varies markedly across regions.

Labour shortages and skills gaps

An adequately skilled and sufficiently large workforce will be central to the energy transition. But shortages of skilled labour in emerging clean energy sectors, coupled with broader labour market difficulties, are already limiting the pace and extent of new projects in several key regions, raising doubts about the speed of the transition in the near to medium term. In China, for example, manufacturers are struggling to fill positions in factories in the face of a declining working population, with young people and college graduates generally more attracted by white-collar jobs (Nulimaimaiti, 2022). The Ministry of Education has estimated that there will be a shortage of almost 30 million workers in China’s manufacturing sector by 2025, including talent gaps of over 9 million in power equipment, over 1 million in new energy vehicles and over a quarter of a million in offshore engineering equipment (Government of China, 2017). Meanwhile, a dearth of tradesmen, such as plumbers, pipefitters, electricians, heating technicians and construction workers, is already restricting the pace of installations of clean energy technologies in Europe and the United States, including solar PV, wind turbines and heat pumps (McGrath, 2021; SEIA, 2021b; Weise, 2022; Hovnanian, Luby & Peloquin, 2022).

Some fast-growing clean energy sectors are also facing a shortage of the requisite skills needed to scale up output. In the wind sector, insufficient training capacity and differences in certification requirements across countries are contributing to

bottlenecks in new installations. The Global Wind Organisation and the Global Wind Energy Council estimate that 480 000 trained workers will be needed to build, install and operate the wind capacity that is planned to come online between 2021 and 2025, but only 150 000 workers had been able to be trained by the end of 2021 (GWO and GWEC, 2021). Offshore wind projects require better trained workers and more labour input per megawatt than onshore projects over their lifetime. There are growing concerns that shortages of trained personnel in the offshore wind sector could delay installations in the coming years (GWEC, 2021).

In the EV sector, skills shortages are already emerging in both production and maintenance. Battery producers are struggling to hire enough research and engineering specialists (Heekyong Yang, 2021), while vehicle technicians and mechanics are unprepared for the impending expansion of EV fleets as ICE bans and EV target deadlines approach (Automotive Management, 2021). Several countries with major hydrogen ambitions, including Canada and the Netherlands, are facing difficulties in finding qualified personnel (Hufnagel-Smith, 2022; CE Delft, 2021). In addition, heat pump manufacturers have flagged a lack of trained labour to install new units as a potential bottleneck for wider deployment.

Millions of jobs will need filling to realise energy transitions

The clean energy transition will involve a massive change in energy sector employment, with many jobs set to be lost in traditional activities in producing and supplying fossil fuels, but many more created in clean energy sectors, including in their supply chains. Filling those new jobs will be key to avoiding bottlenecks and speeding up transitions around the world.

Global energy sector employment grows from around 65 million today to almost 90 million in 2030 in the NZE Scenario. Nearly all of the new jobs are in clean energy sectors. Employment in oil, gas and coal fuel supply and at power plants that are not equipped with carbon capture facilities declines by around 8.5 million to 13 million over the same period (Figure 1.22). The deployment of clean technologies in the NZE Scenario implies a need to recruit a large number of workers in those sectors. For example, jobs in wind and solar PV increase by almost 10% per year on average over 2021-2030 as capacity additions continue to grow. With the share of EVs in total car sales reaching over 60% in 2030, more people work in manufacturing EVs, including their batteries, than in making ICE vehicles.

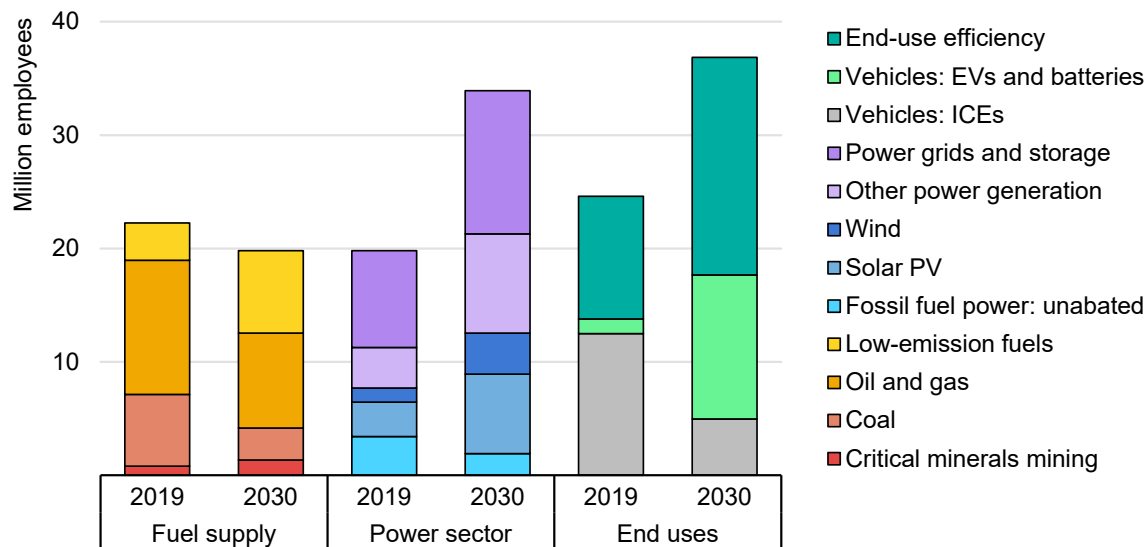
Figure 1.22 Global energy sector employment by technology in the NZE Scenario

IEA. CC BY 4.0.

Note: End-use efficiency employment refers to employment in efficiency improvements for buildings and industry; for more details please refer to the World Energy Employment report methodology.

Sources: IEA analysis based on IEA (2022n).

Clean energy sector employment soars in the NZE, from 32 million in 2019 to 70 million in 2030, more than offsetting the loss of 8.5 million jobs in fossil fuel and related industries.

More skilled workers are needed in the clean energy sector

Overall, the energy sector employs more highly skilled workers than other industries, with 45% of the workforce requiring some degree of tertiary education, from university degrees to vocational certifications, compared with the economy-wide average of 24% (Figure 1.23). Many energy firms are already facing a very competitive environment for hiring candidates with the needed skill sets, particularly for positions in the field of science, technology, engineering and mathematics (STEM), followed by project managers and other technical roles (IEA, 2022n). The biggest hiring gaps globally at present are in project management and information technology (IT) (Global Energy Talent Index, 2022). The continuing shift in employment to clean energy jobs could exacerbate these skill shortages.

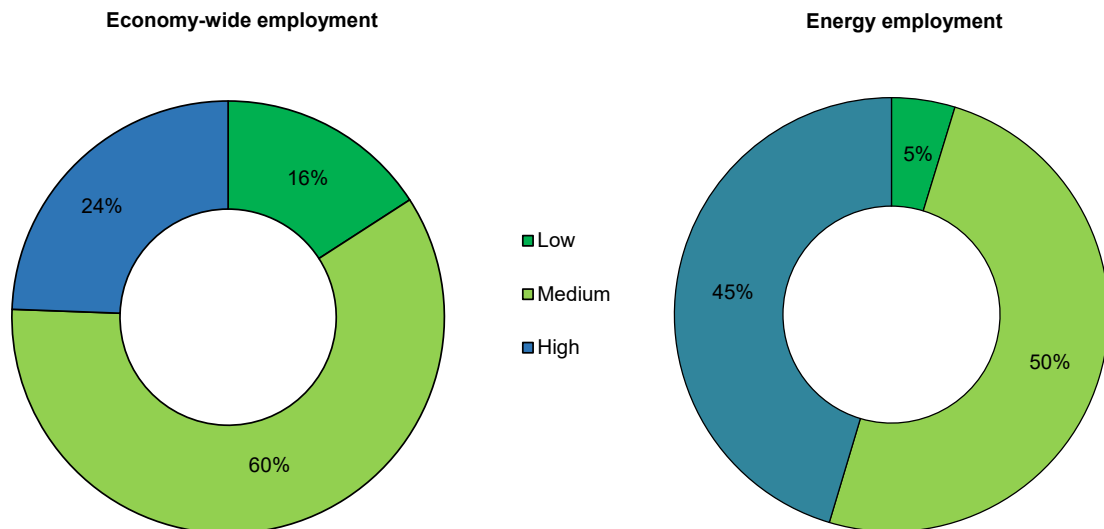
Figure 1.23 Global employment by skill level, 2019

IEA. CC BY 4.0.

Note: High skill level refers to ISCO-08 skill levels 3 and 4, medium to ISCO-08 skill level 2 and low to ISCO-08 skill level 1. Sources: IEA analysis based on IEA (2022n); International Labour Organization (2022).

The energy sector demands more highly skilled workers than other industries, with 45% of the workforce having some form of tertiary education.

The specific skills required in the supply of clean energy and the current labour shortages vary considerably according to the type of technology. In the power sector, safety experts, construction managers, cybersecurity professionals and software developers, as well as skilled middle-management project engineers, are already difficult to recruit (Naschert, 2022). The broader dearth of construction workers and tradespeople is starting to limit solar and wind power capacity additions in some locations. There is also a widespread shortage of electricians who require multi-year training (SEIA, 2021a). In the case of renewables, around two-thirds of solar PV and onshore wind jobs require minimal formal training, whereas 30% of jobs require STEM degrees and 5% of jobs are for highly qualified non-STEM professionals such as lawyers and regulation experts (IRENA, 2021). In power grids, increased digitalisation of networks is boosting the need for IT skills. The biggest skills shortages today in renewables are in construction and engineering; followed by planning, organising and scheduling; project development; and on-site construction and fabrication (Global Energy Talent Index, 2022). In hydrogen production, there is strong demand for engineering skills, as well as those in designing, operating and maintaining hydrogen infrastructure and vehicles.

Skills shortages are less of a constraint to expanding capacity in some other areas. In the case of EVs, many manufacturing-related skills can generally be transferred from ICEs. In addition, EVs tend to have fewer components than ICEs, simplifying the assembly process. However, for the maintenance and repair of EVs, more

mechanics will need to receive electrical training to handle high-voltage batteries (Institute of the Motor Industry, 2021). EV battery producers have also been facing shortages in research and development (Heekyong Yang, 2021).

Some fossil fuel workers have skills that can be transferred to clean energy sectors, which will help alleviate shortages and provide them with new opportunities. For example, coal miners have skills that can be used in mining critical minerals. Based on new geospatial analysis carried out by the IEA, an estimated 40% of coal workers worldwide are employed within 200 km of a critical mineral reserve. Nonetheless, opportunities for shifting mining and related jobs will be limited, especially as the volumes of critical minerals needing to be mined is small when compared with the volume of coal mined today.

It may also be possible to transfer some marine-based technical skills from the offshore oil and gas industry to the offshore wind sector, including hydrodynamics, shipping operations and the application of health and safety rules (C&S Partners, 2021). Oil and gas engineering skills are highly applicable to CCUS and geothermal including seismic interpretation, drilling and well completions, reservoir mapping, and flow assurance. The Integrated People and Skills Strategy of the United Kingdom's North Sea Transition Deal estimates that 90% of the existing UK oil and gas workforce have medium to high skills transferability, with over half of the existing oil and gas workforce open to considering a move into offshore wind or renewables generally (Energy Skills Alliance, 2022). Chemical engineers in refineries have skills that are useful in the production of biofuels and hydrogen and raw materials extraction.

References

- Automotive Management (2021), EV skills gap will materialise in 2026, warns the IMI, 10 November <https://www.am-online.com/news/aftersales/2021/11/10/ev-skills-gap-will-materialise-in-2026-warns-the-imi>
- Bartholomeusz, S. (2022), The world has a big problem in the drive to net zero, The Age, 24 October <https://www.theage.com.au/business/markets/the-world-has-a-big-problem-in-the-drive-to-net-zero-20221024-p5bs8w.html>
- Berthélemy, M., & Rangel, L. (2013), Nuclear reactors' construction costs: The role of lead time, standardization and technological progress, <https://hal.archives-ouvertes.fr/hal-00956292/document>
- BNEF (BloombergNEF) (2022), 1H 2022 Battery Metals Outlook: Supply Turbulence Ahead.
- BNEF (2020), Global Nickel Outlook 2020-2030.
- C&S Partners (2021), Materializing leadership: From oil and gas to renewable energies, <https://concretesteelpartners.com/wp-content/uploads/2021/06/Odd-Stromsnes-From-OG-to-Renewable-publish.pdf>
- CE Delft (2021), Jobs from investment in green hydrogen, https://cedelft.eu/wp-content/uploads/sites/2/2021/04/CE_Delft_200427_Jobs_from_investment_in_green_hydrogen_Def.pdf
- China, NDRC (National Development and Reform Commission) (2021), Action Plan for Carbon Dioxide Peaking Before 2030, https://en.ndrc.gov.cn/policies/202110/t20211027_1301020.html
- China, NEA (National Energy Administration) (2022), Science and technology support carbon peak carbon neutral implementation plan (2022-2030) issued [translated], http://www.nea.gov.cn/2022-08/19/c_1310654062.htm
- Comin, D., & Hohjin, B. (2004), Cross-country technological adoption: Making the theories face the facts, Journal of Monetary Economics, January 2004, pp. 39-83, <https://www.nber.org/research/data/historical-cross-country-technology-adoption-hccta-dataset>
- EC (European Commission) (2022), REPowerEU: A plan to rapidly reduce dependence on Russian fossil fuels and fast forward the green transition, https://ec.europa.eu/commission/presscorner/detail/en/IP_22_3131
- EC (2020), Study on the EU's list of critical raw materials, Factsheets on Critical Raw Materials https://lecho-circulaire.com/wp-content/uploads/2020/09/CRM_2020_Factsheets_critical_Final.pdf
- European Council (2022), Fit for 55, <https://www.consilium.europa.eu/en/policies/green-deal/fit-for-55-the-eu-plan-for-a-green-transition/>
- Energy Skills Alliance (2022), North Sea transition deal: Integrated people and skills strategy, <https://www.offshoreenergypeopleandskills.co.uk/public/img/docs/NSTD-Integrated-People%20and-Skills-Strategy-FINAL.pdf>
- First Movers Coalition (2022), *First Movers Coalition Members*. Retrieved from: <https://www.weforum.org/first-movers-coalition/members>
- Fraser, J. et al. (2021), Study on future demand and supply security of nickel for electric vehicle batteries, Publications Office of the European Union, Luxembourg, doi:10.2760/212807.

- Global Energy Talent Index (2022), The Global Energy Talent Index Report 2022, https://f.hubspotusercontent30.net/hubfs/3277184/Gated%20PDFS/GETI%202022%20Web%20Version.pdf?utm_campaign=GETI%202022&utm_medium=email&_hsmt=206292796&_hsenc=p2ANqtz--ysq6hThu1Smj37rhXyfwQp-E07Hwn8cm1iVQq9k1AFhXhuronKGwrZ_kdCC04IRp5Yx7RTEsQYXtiJrVmAdGYZ
- Government of China (2017), Notice of the Three Departments on Printing and Distributing the "Guidelines for the Development of Manufacturing Talents", The State Council of the People's Republic of China, http://www.gov.cn/xinwen/2017-02/24/content_5170697.htm
- Government of India (2022), India's updated first Nationally Determined Contribution under Paris Agreement (2021-2030), <https://unfccc.int/sites/default/files/NDC/2022-08/India%20Updated%20First%20Nationally%20Determined%20Contrib.pdf>
- Greening, B., & Azapagic, A. (2012), Domestic heat pumps: Life cycle environmental impacts and potential implications for the UK, *Energy*, Vol. 39/1, pp. 205-217, <https://doi.org/10.1016/j.energy.2012.01.028>
- Gross, R. et al. (2018), How long does innovation and commercialisation in the energy sectors take? Historical case studies of the timescale from invention to widespread commercialisation in energy supply and end-use technology, *Energy Policy*, Vol. 123, pp. 682-699, <https://doi.org/10.1016/j.enpol.2018.08.061>
- GWEC (Global Wind Energy Council) (2021), Wind can power 3.3 million new jobs over next five years, <https://gwec.net/wp-content/uploads/2021/04/Jobs-Note-April-2021-2.pdf>
- GWO (Global Wind Organisation) and GWEC (2021), Global wind workforce outlook 2021-2025, <https://gwec.net/wp-content/uploads/2021/06/Global-Wind-Workforce-Outlook-2021-2025.pdf>
- H2 Green Steel (2022), *H2 Green Steel has pre-sold over 1.5 million tonnes of green steel to customers*. 10 May, <https://www.h2greensteel.com/latestnews/h2-green-steel-has-pre-sold-over-15-million-tonnes-of-green-steel-to-customers>
- Heekyong Yang (2021), Battery giants face skills gap that could jam electric highway, Reuters, 5 October, <https://www.reuters.com/business/autos-transportation/battery-giants-face-skills-gap-that-could-jam-electric-highway-2021-10-04/>
- Heijlen, W. et al. (2021), Assessing the adequacy of the global land-based mine development pipeline in the light of future high-demand scenarios: The case of the battery-metals nickel (Ni) and cobalt (Co), *Resources Policy*, Vol. 73, 102202, <https://www.sciencedirect.com/science/article/pii/S0301420721002166>
- Hovnanian, G., Luby, R. & Peloquin, S. (2022), Bridging the labor mismatch in US construction, McKinsey, 28 March <https://www.mckinsey.com/capabilities/operations/our-insights/bridging-the-labor-mismatch-in-us-construction>
- Hufnagel-Smith, P. (2022), Assessing the workforce required to advance Canada's hydrogen economy, Transition Accelerator, https://transitionaccelerator.ca/wp-content/uploads/2022/07/Assessing-Workforce-Required-to-Advance-Canadas-Hydrogen-Economy_Version_1.pdf
- IEA (International Energy Agency) (2022a), An Energy Sector Roadmap to Net Zero Emissions in Indonesia, <https://www.iea.org/reports/an-energy-sector-roadmap-to-net-zero-emissions-in-indonesia>

- IEA (2022b), World Energy Outlook 2022, <https://www.iea.org/reports/world-energy-outlook-2022>
- IEA (2022c), COP26 climate pledges could help limit global warming to 1.8 °C, but implementing them will be the key, <https://www.iea.org/commentaries/cop26-climate-pledges-could-help-limit-global-warming-to-1-8-c-but-implementing-them-will-be-the-key>
- IEA (2022d), Tracking Clean Energy Progress: Renewable Electricity, <https://www.iea.org/reports/renewable-electricity>
- IEA (2022e), Global EV Outlook 2022, <https://www.iea.org/reports/global-ev-outlook-2022>
- IEA (2022f), World Energy Investment, <https://www.iea.org/reports/world-energy-investment-2022>
- IEA (2022g), Tracking Clean Energy Progress, <https://www.iea.org/topics/tracking-clean-energy-progress>
- IEA (2022h), The Need for Net Zero Demonstration Projects, <https://www.iea.org/reports/the-need-for-net-zero-demonstration-projects>
- IEA (2022i), Global Hydrogen Review 2022, <https://www.iea.org/reports/global-hydrogen-review-2022>
- IEA (2022j), Energy Technology Perspectives: Clean Energy Technology Guide, <https://www.iea.org/data-and-statistics/data-tools/etp-clean-energy-technology-guide>
- IEA (2022k), Solar PV Global Supply Chains, <https://www.iea.org/reports/solar-pv-global-supply-chains>
- IEA (2022l), Electric cars fend off supply challenges to more than double global sales, <https://www.iea.org/commentaries/electric-cars-fend-off-supply-challenges-to-more-than-double-global-sales>
- IEA (2022m), Renewables 2022, <https://www.iea.org/reports/renewables-2022>
- IEA (2022n), World Energy Employment, <https://www.iea.org/reports/world-energy-employment>. Also see World Energy Employment Methodology, <https://iea.blob.core.windows.net/assets/a0432c97-14af-4fc7-b3bf-c409fb7e4ab8/WorldEnergyEmployment.pdf>
- IEA (2021a), An energy sector roadmap to carbon neutrality in China, <https://www.iea.org/reports/an-energy-sector-roadmap-to-carbon-neutrality-in-china>
- IEA (2021b), The Role of Critical Minerals in Clean Energy Transitions, <https://iea.blob.core.windows.net/assets/ffd2a83b-8c30-4e9d-980a-52b6d9a86fdc/TheRoleofCriticalMineralsinCleanEnergyTransitions.pdf>
- IEA (2021c), The cost of capital in clean energy transitions, <https://www.iea.org/articles/the-cost-of-capital-in-clean-energy-transitions>
- IEA (2020a), Clean Energy Innovation, <https://www.iea.org/reports/clean-energy-innovation>
- IEA (2020b), Iron and Steel Technology Roadmap, <https://www.iea.org/reports/iron-and-steel-technology-roadmap>
- IMF (International Monetary Fund) (2022), Primary Commodity Price System, <https://data.imf.org/?sk=471DDDF8-D8A7-499A-81BA-5B332C01F8B9>
- India, MCI (Ministry of Commerce and Industry) (2021a), Production Linked Incentive Scheme, <https://pib.gov.in/PressReleasePage.aspx?PRID=1703785>

- India, MCI (2021b), Status of Production-Linked Incentive Schemes, <https://pib.gov.in/PressReleaseFramePage.aspx?PRID=1710134>
- India, MHI (Ministry of Heavy Industries) (2022a), Allotment made for 50 GWh of battery capacity to 4 successful bidders for incentive under (PLI) Scheme for Advanced Chemistry Cell (ACC) Battery Storage, <https://pib.gov.in/PressReleasePage.aspx?PRID=1809037>
- India, MHI (2022b), The Production Linked Incentive (PLI) Scheme for Automobile and Auto Component successful in attracting proposed investment of ₹ 74,850 crore against the target estimate of investment ₹ 42,500 crore over a period of five years, <https://pib.gov.in/PressReleasePage.aspx?PRID=1806077>
- India, MNRE (Ministry of New and Renewable Energy) (2022), Production Linked Incentive Scheme (Tranche II) under 'National Programme on High Efficiency Solar PV Modules', https://mnre.gov.in/img/documents/uploads/file_f-1664601098820.pdf
- India, Union Cabinet (2020), Cabinet approves PLI Scheme to 10 key Sectors for Enhancing India's Manufacturing Capabilities and Enhancing Exports, <https://www.pib.gov.in/PressReleasePage.aspx?PRID=1671912>
- InfoLink (2022), InfoLink online database, <https://www.infolink-group.com/index/en>
- Institute of the Motor Industry (2021), 7 June Skilled EV workforce not keeping pace with new vehicle sales, <https://tide.theimi.org.uk/industry-latest/news/skilled-ev-workforce-not-keeping-pace-new-vehicle-sales>
- International Labour Organization (2022), International Standard Classification of Occupations (ISCO), <https://ilostat.ilo.org/resources/concepts-and-definitions/classification-occupation>
- IRENA (International Renewable Energy Agency) (2021), Renewable Energy and Jobs Annual Review 2021, https://www.irena.org/-/media/Files/IRENA/Agency/Publication/2021/Oct/IRENA_RE_Jobs_2021.pdf
- Japan, METI (Ministry of Energy, Trade and Industry) (2021), Japan's roadmap to "Beyond-Zero" carbon, https://www.meti.go.jp/english/policy/energy_environment/global_warming/roadmap/
- Nulimaimaiti, M. (2022), China's factories are wrestling with labour shortages. Age-old prejudice partly explains why, South China Morning Post, 13 January, <https://www.scmp.com/economy/china-economy/article/3163097/chinas-factories-are-wrestling-labour-shortages-age-old>
- McGrath, J. (2021), Report on Labour Shortages and Surpluses November 2021, European Labor Authority, <https://www.ela.europa.eu/sites/default/files/2021-12/2021%20Labour%20shortages%20%20surpluses%20report.pdf>
- MPP (Mission Possible Partnership) (2022), Making Net-Zero 1.5°C-Aligned Aluminium Possible, <https://www.energy-transitions.org/publications/making-net-zero-aluminium-possible/>
- Naschert, C. (2022), Skills shortage imperils global energy transition, 12 September, S&P Global, <https://www.spglobal.com/marketintelligence/en/news-insights/latest-news-headlines/skills-shortage-imperils-global-energy-transition-71565735>
- NEDO (New Energy and Industrial Technology Development Organization) (2021), Overview of the Green Innovation Fund projects, <https://green-innovation.nedo.go.jp/en/about/>

- OECD (Organisation for Economic Co-operation and Development) (2022a), Where do my things come from? How trade works today, <https://www.oecd.org/trade/understanding-the-global-trading-system/how-trade-works/>
- OECD (2022b), Why open markets matter, <https://www.oecd.org/trade/understanding-the-global-trading-system/why-open-markets-matter/>
- Richter, F. (2022), From zero COVID-19 vaccines to 11.2 billion in a year, World Economic Forum, 4 January <https://www.weforum.org/agenda/2022/01/covid-19-vaccines-2021/>
- S&P Capital (2022), Lithium project pipeline insufficient to meet looming major deficit.
- S&P Global (2022a), Copper global supply-demand balance, August 2022.
- S&P Global (2022b), COVID-19 recovery boosted capex 16% in 2021; larger recovery expected.
- S&P Global (2022c), Iron ore global supply-demand balance, August 2022.
- S&P Global (2022d), Lithium and cobalt global supply-demand balance, January 2022.
- S&P Global (2022e), Commodity Insights, <https://www.spglobal.com/commodityinsights/en>
- S&P Global (2020), Top mines average time from discovery to production: 16.9 years, <https://www.spglobal.com>
- S&P Global (2019), Lithium supply is set to triple by 2025. Will it be enough?, <https://www.spglobal.com>
- Saoud, A., Harajli, H., & Manneh, R. (2021), Cradle-to-grave life cycle assessment of an air to water heat pump: Case study for the Lebanese context and comparison with solar and conventional electric water heaters for residential application, Journal of Building Engineering, Vol. 44, 103253, <https://doi.org/10.1016/j.jobbe.2021.103253>
- Schlömer, S. et al. (2014), Annex III: Technology-specific cost and performance parameters, https://www.ipcc.ch/site/assets/uploads/2018/02/ipcc_wg3_ar5_annex-iii.pdf
- SEIA (Solar Energy Industries Association) (2021a), The U.S. solar workforce, <https://www.seia.org/sites/default/files/2021-05/SEIA-Solar-Workforce-Labor-Factsheet-May2021.pdf>
- SEIA (2021b), National Solar Jobs Census 2020, <https://www.seia.org/sites/default/files/2021-05/National-Solar-Jobs-Census-2020-FINAL.pdf>
- SteelZero (2022), *SteelZero Members*. <https://www.theclimategroup.org/steelzero-members>
- UNECE (United Nations Economic Commission for Europe) (2022), Major auto markets join forces for draft UN legislation on electric vehicle battery durability, 12 October, <https://unece.org/circular-economy/press/major-auto-markets-join-forces-draft-un-legislation-electric-vehicle-battery>
- United Kingdom, Department for Business, Energy & Industrial Strategy (2020), Heat Pump Manufacturing Supply Chain Research Project, https://assets.publishing.service.gov.uk/government/uploads/system/uploads/attachment_data/file/943712/heat-pump-manufacturing-supply-chain-research-project-report.pdf
- US Congress (2022), H.R.5376 – Inflation Reduction Act of 2022, <https://www.congress.gov/bill/117th-congress/house-bill/5376/text>
- US Department of Energy (2022), United States announces \$94 billion of global public funding to accelerate clean energy worldwide, 23 September, <https://www.energy.gov/articles/united-states-announces-94-billion-global-public-funding-accelerate-clean-energy-worldwide>

USGS (United States Geological Survey) (2022), Mineral Commodity Summary 2022, <https://pubs.usgs.gov/periodicals/mcs2022/mcs2022.pdf>

Violante, A.C. et al. (2022), Comparative life cycle assessment of the ground source heat pump vs air source heat pump, Renewable Energy, Vol. 188, pp. 1029-1037, <https://doi.org/10.1016/j.renene.2022.02.075>

Weise, Z. (2022), EU looks at an electric alternative to Russian gas: The heat pump, Politico, 18 March, <https://www.politico.eu/article/eu-heat-pumps-stop-russia-gas/>

Worldsteel Association (2020), Steel Statistical Yearbook, <https://www.worldsteel.org/publications/bookshop/product-details%7E2020-Monthly-crude-steel-and-iron-production-statistics-Steel-Statistical-Yearbook-%7EPRODUCT%7Estatistics2020%7E.html>

Chapter 2. Mapping out clean energy supply chains

Highlights

- The production of critical minerals is highly concentrated geographically, raising concerns about security of supplies. The Democratic Republic of Congo supplies 70% of cobalt today; China 60% of rare earth elements (REEs); and Indonesia 40% of nickel. Australia accounts for 55% of lithium mining and Chile for 25%. Processing of these minerals is also highly concentrated, with China being responsible for the refining of 90% of REEs and 60-70% of lithium and cobalt. China also dominates bulk material supply, accounting for around half of global crude steel, cement and aluminium output, though most is used domestically.
- China is the leading global supplier of clean energy technologies today and a net exporter for many of them. China holds at least 60% of the world's manufacturing capacity for most mass-manufactured technologies (e.g. solar PV, wind systems and batteries), and 40% of electrolyser manufacturing. Europe is generally a net importer, with the exception of wind turbine components; about one-quarter of electric cars and batteries, and nearly all solar PV modules and fuel cells are imported, mostly from China. For solar PV, China supplies equipment directly to all markets except North America. The United States imports two-thirds of its PV modules, primarily from Southeast Asia, where Chinese companies have been actively investing.
- Recent supply chain disruptions resulting from the Covid-19 pandemic and Russia's invasion of Ukraine, combined with rapidly growing demand, have dramatically increased the cost of materials and energy. The average price of lithium was nearly four times higher in 2022 than in 2019, and twice for cobalt and nickel. Batterymetal price hikes in early 2022 led to increasing battery prices – up nearly 10% globally relative to 2021 – after years of continuous decline. The price of solar PV-grade polysilicon, copper and steel all roughly doubled between the first half of 2020 and that of 2022. These increases contributed to pushing up the price of PV modules rising by 25% and that of wind turbines outside China rising by up to 20%.
- Clean energy technologies have far lower life-cycle CO₂ intensities than their fossil counterparts, but their supply chains are still an important source of CO₂ emissions and other pollutants. Material production and technology manufacturing typically account for over 90% of the emissions for the clean energy technology supply chains analysed. Reducing emissions from these steps is challenging, given the current lack of commercially available low-emission technologies in many cases, but an important undertaking in the transition to net zero emissions.

Assessing vulnerabilities in supply chains

Understanding the functioning of clean energy supply chains today and their vulnerabilities is crucial to lay the foundations for expanding them as the clean energy transition advances (Table 2.1). The goal must be to ensure that both energy and technology supply chains are secure, resilient and sustainable. This chapter assesses those vulnerabilities in detail for selected clean energy supply chains, focusing on the link between geographic concentration and security, resilience to market shocks, and environmental performance.

The clean energy transition is affecting the nature of **energy security**, which depends on adequate and timely investments to ensure supply stays in line with demand. The move to clean energy is shifting the focus from fossil fuels to critical minerals, though the former will remain important to energy security during the transition, especially at its early stages. Compared with fossil fuel supply, the supply chains for clean energy technologies today are generally more geographically concentrated. Global supply chains are not always more vulnerable than domestic ones and may be necessary due to a lack of economically viable domestic resources for individual steps of supply chains. However, some external sources of key materials and components may be considered insecure. This is a particular concern if a large share of supply comes from countries subject to acute geopolitical risks due to conflict, social instability, unfair trade practices or human rights issues. The global energy crisis has reinforced this concern. In the longer term, as countries approach net zero emissions, demand for primary inputs to clean energy supply chains should start to decline, as new capacity is required mainly to meet new energy demand rather than also replace existing fossil fuel incumbent technologies.

Building **resilience** to disruptions along supply chains is vital to mitigating emerging problems for energy systems. Most low-emission technologies rely on domestic energy resources, such as sunshine and wind, but the equipment, critical minerals, materials and components needed to exploit those and produce end-use equipment often rely on global supply chains. An oil supply crisis, when it happens, has broad repercussions across the economy. The supply of electricity, which is set to play an increasingly important role in meeting energy needs, low-emission hydrogen and derivative fuels (including ammonia), and bioenergy/biofuels will face similar threats in the future. A shortage or spike in the price of a raw material or component required for producing key clean energy technologies such as batteries, solar panels or electrolyzers will affect their availability, which could lead to delays in decarbonising the energy system and increasing the overall costs of the energy transition.

The goal of **sustainability** concerns energy technology supply chains as well as the supply of energy itself. The use of clean energy technologies may involve

fewer emissions, but their supply chains may result in significant emissions and other environmental impacts. Today, emissions from clean energy supply chains come mainly from bulk materials production. Reducing them will be tough, since many of the technologies required to do so are not yet commercially available. Mining and technology manufacturing are also responsible for a significant share of emissions, but reducing them should be easier since there is greater scope for switching to electricity. In any case, the emissions from supply chains and other environmental impacts should not be a reason to stall the rapid roll-out of clean technologies in the near term, since in most cases supply chain emissions are dwarfed by those that are saved as a result of their use.

Supply chains need to meet the needs of a net zero energy system while themselves being compatible with it, and be able to absorb, accommodate and recover from both short-term shocks and long-term changes, including material shortages, climate change, natural disasters and other potential supply disruptions. The goal should be to achieve this while maintaining a commitment to the principles of open and transparent markets. Self-sufficiency is not always an option – particularly for some elements of the supply chain that are bound to the availability of certain natural resources that are geographically concentrated – nor necessarily an economically optimal approach. A combination of open markets within the rules of the World Trade Organization, strategic partnerships and diversity of supply sources will, in many cases, be a better approach (see Chapter 6).

Table 2.1 Characteristics of secure, resilient and sustainable clean energy technology supply chains

Objective	Characteristics
Secure	Adequate, reliable and uninterrupted supply of inputs. Diversity in market, suppliers and technologies.
Resilient	Able to respond and quickly adjust to sudden market shocks on prices or demand. Stable and affordable prices. Effective interconnection with other supply chains that can deliver an equivalent technology or service.
Sustainable	Greenhouse gas emissions as low as possible and consistent with climate objectives. True supply chain transparency and impact assessments (e.g. air and water pollution, biosphere protection) with strengthening environmental, social and governance measures (ESG) along the entire supply chain. Efficient and responsible use of natural resources, including through promotion of material efficiency and end-of-life stewardship.

Box 2.1 Clean energy supply chains interdependencies

Supply chains link suppliers of inputs to consumers of outputs, often spanning multiple sectors and countries to form complex networks. These interdependencies are also vulnerabilities in terms of resilience. In the case of clean energy, certain technologies and technology or energy supply chains are “foundational”, i.e. without them, the superstructure of supply chains would not be able to function properly. For example, any disruption to low-emission electricity supply would directly affect low-emission hydrogen production, and in turn low-emission synthetic hydrocarbon fuels production (Figure 2.1).

Figure 2.1 Interconnections between selected energy and technology supply chains

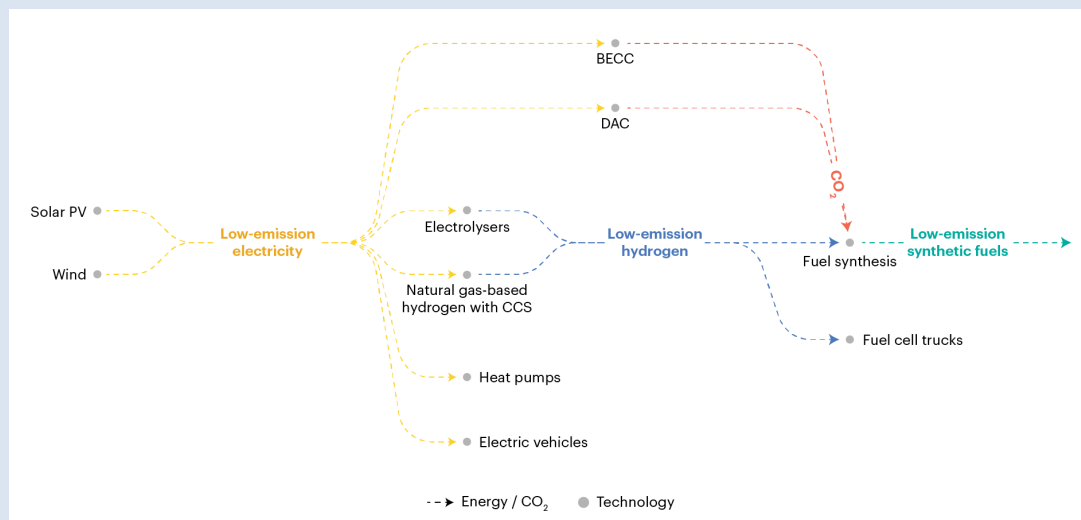

IEA. CC BY 4.0.

Notes: DAC = direct air capture. BECC = bioenergy with carbon capture.

The use of cross-cutting technologies can also expose the clean energy system and supply chains to new vulnerabilities. These technologies are typically deployed in different sectors and supply chain steps, hence have broad impacts in case of disruption. For example, carbon capture, utilisation and storage (CCUS) can contribute to decarbonising industry, power and fossil-based hydrogen production, as well as provide carbon dioxide removal and CO₂ for synthetic fuel production. As a result, disruptions in the supply of CO₂ capture components or along the CO₂ transport and storage infrastructure could have an impact on clean energy supply across several sectors.

It is crucial that industry and policy makers assess these vulnerabilities at the system level and reduce them through targeted measures, such as by deliberately building redundancy into the system in the form of overcapacity or alternative supply or production routes.

Geographic diversity and energy security

Extraction of critical minerals

The shift from fossil energy to less emissions-intensive technologies and fuels will fundamentally change global energy supply chains, including the types of natural resources needed. In particular, clean technologies depend much more on critical minerals. While the world’s resources of these minerals are very large and unlikely to constrain supply in the long term, production and processing operations for many of them are highly concentrated in a small number of countries at present, making supplies vulnerable to political instability, geopolitical risks and export restrictions. In general, the supply of critical minerals is more geographically concentrated than that of oil, gas and coal.

Figure 2.2 Regional shares of global fossil fuel and uranium production and resources, 2021

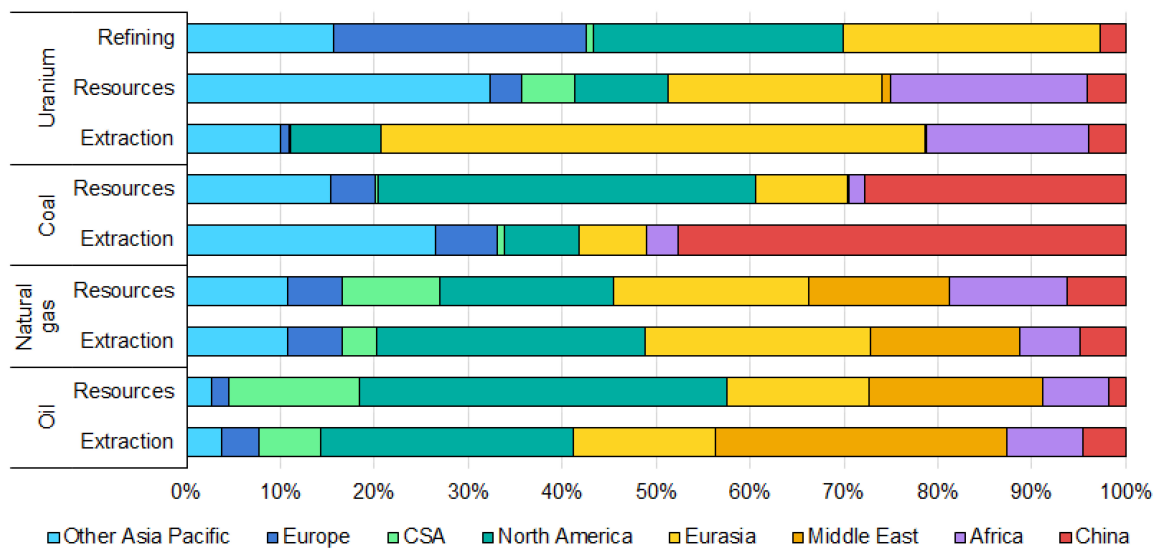

IEA. CC BY 4.0.

Notes: CSA = Central and South America. Uranium resources are identified uranium resources assuming an international market price of USD 130/kg. Fossil fuel resources consider the remaining technically recoverable resources.

Sources: IEA analysis based on IEA data; WISE Uranium Project (2020).

Fossil fuel production today is concentrated in North America, the Middle East and China.

The countries that dominate minerals production today are generally very different to the leading producers of fossil fuels (Figure 2.2, Figure 2.3). The United States is currently the world’s biggest producer of both oil and gas, but features prominently only in silver, copper and rare earth elements (REEs) mining. Although the People’s Republic of China (hereafter, “China”) is the world’s leading producer of coal, it has relatively small resources of oil and gas. Yet it dominates production of REEs, accounting for 60% of global output, and is also a big

producer of iron ore, lithium and copper. While several countries in the Middle East are major oil and gas producers, they produce very few critical minerals. The mining of those minerals is concentrated in Africa, South America, Australia and Indonesia, while their processing is concentrated in China.

Figure 2.3 Global reserves and extraction of selected resources by region, 2021

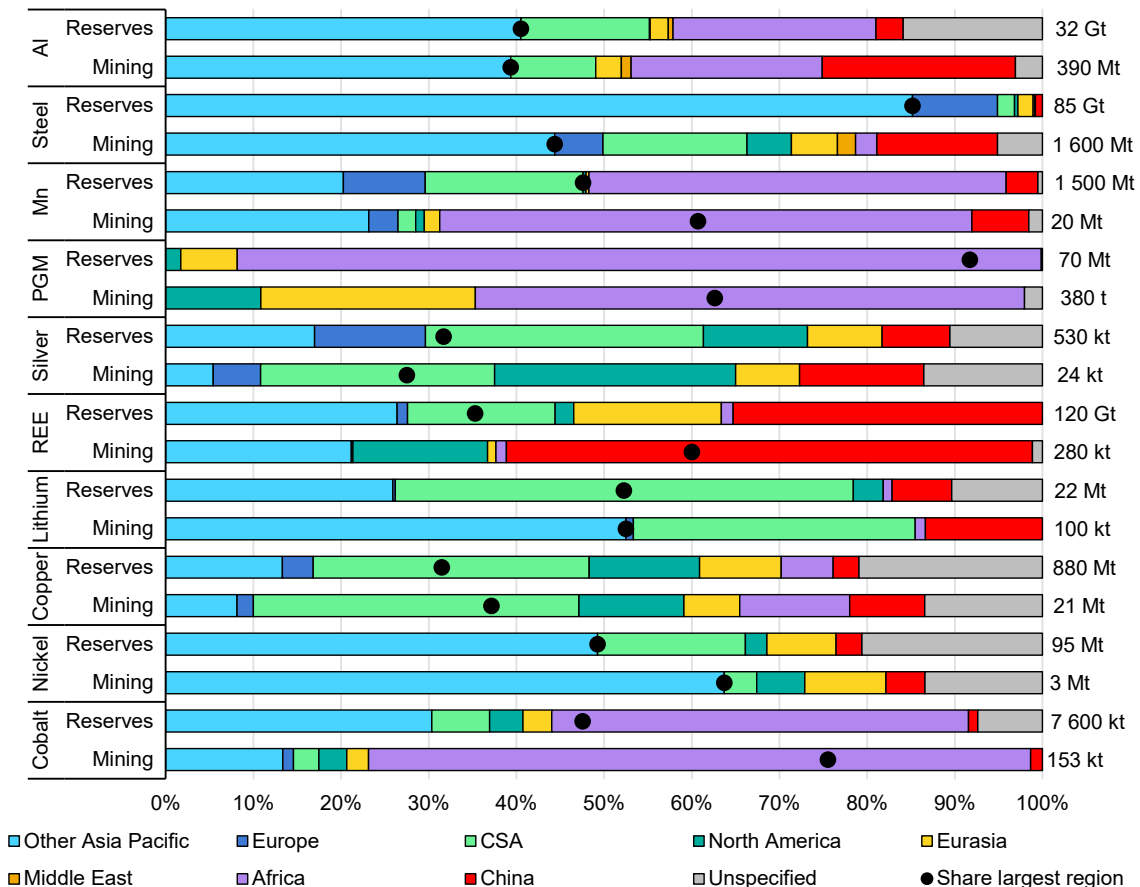

IEA. CC BY 4.0.

Notes: Al = aluminium; Mn = manganese; PGM = platinum group metals; REE = rare earth elements; CSA = Central and South America. PGM mining includes only platinum and iridium. Reserves data are uncertain as companies and countries do not always disclose their full reserves.

Sources: IEA analysis based on USGS (2022); S&P Global (2022a).

Leading countries in minerals extraction today are very different from fossil fuel producers, with mining concentrated in Africa, South America and Asia Pacific.

The degree of geographic concentration of critical minerals today varies significantly. For lithium, cobalt and REEs, the top three producing nations control three-quarters or more of global output. South Africa supplies more than 70% of the world’s platinum needs for all uses – one of the highest concentrations of any mineral. Mining of ores of cobalt, which is a vital component of lithium-ion (Li-ion) batteries and superalloys used in turbines, nuclear reactors and sensors, is also highly concentrated, with the Democratic Republic of Congo holding 70% of global

production, although the majority of those mines are owned by Chinese firms. Mining companies pay back the government with royalties at rates that are 4-8% of mining revenues. There are serious claims that corruption and other factors deprive communities of such benefits (Eurometaux, 2022). For lithium, Australia accounts for 55% of mining and Chile over 25%. Output of copper ores is the least concentrated of all the main critical minerals, with the three leading producers – Chile, Peru and China – accounting for less than half of global supply. Market concentration is also high. For instance, the top five lithium producing companies controlled almost 80% of global mining capacity in 2021 (BNEF, 2021a).

Proven reserves for most critical minerals are more geographically widespread than current production.⁸ This suggests that there is considerable scope for increasing the diversity of the sources of these minerals and reducing over-reliance on a small number of major producers. For REEs, the distribution of reserves is very different to that of current mining, implying that many countries have considerable potential to boost output. Political, economic and environmental factors affect the extent to which each region may be willing to exploit its resources. For example, while Chinese reserves of REEs account for less than 40% of global reserves, about 60% of global REE extraction takes place in China, illustrating the government's strong support for critical mineral production.

Box 2.2 The different steps of metal production

Producing metals involves many steps and processes that cut across different elements of supply chains to convert the raw material, such as a metallic ore (a compound containing the metal), to a final form in which the metal can be used as an input to manufacturing. The principal steps are as follows:

- Exploration and mining of the ore, including the removal of soil and rock to gain access to it. Most ores are extracted from open-cast or underground mines, but a few metals, such as magnesium, are partly extracted from seawater using electrolysis (passing an electric current through a water solution of the compound). The energy intensity of this step is affected by the stripping ratio (of waste rock to ore) and the grade of ore. In this report, this step is simply referred to as mining.
- Transportation of the ore after crushing to a mill or processing plant, usually in bulk or in large bags.
- Purification of the ore, involving the separation of the metal from various impurities contained in the ore (usually through a combination of sieving and

⁸ Reserves are defined as known resources and quantified deposits that can be economically extracted. Reserves are smaller than resources, which are the amount of both discovered and suspected undiscovered deposits. Geological discoveries and changes in technology and market prices can affect what are considered reserves.

flotation methods using water and chemicals). Low ore grade minerals require more purification steps, resulting in higher energy and emissions intensities.

- Storage of tailings – leftover materials from the processing of mined ore – usually in the form of slurry in water-filled pools known as tailings dams to prevent tailing powder from blowing away and polluting the area surrounding the mine (see Box 2.6).
- Reduction of the ore (the conversion of the ore from its oxidised state to its pure form) through smelting to produce metals that can be used in manufacturing. For example, iron is currently mostly reduced by reacting iron oxide with carbon and carbon monoxide in a blast furnace. In this report, refining and reduction steps are simply referred to as materials production.

Critical and bulk materials production

Processing of critical minerals is more concentrated than reserves

After minerals are extracted from the ground, they first need to be processed and refined to reach the required level of purity for use. For example, EV battery manufacturing requires nickel sulfate, which can be produced from nickel sulfides and hydroxides or can be derived from refined nickel, which itself is produced through a purification of raw nickel ore (Le Gleuher, 2022). These steps involve advanced physical and chemical treatment techniques, which can be highly energy-, capital- and skills-intensive.

The degree of geographical concentration of critical materials production is even greater than that of minerals extraction (Figure 2.4). China dominates processing of several of them: it holds a share of around 30% of global processing for nickel (the figure is higher if the involvement of Chinese companies in Indonesian operations is included), 60-70% for lithium and cobalt, and as high as 90% for REEs (to convert them into oxides, metals and magnets). No other country controls more than a fifth of critical materials production, with the exception of Chile, which processes almost one-third of the world's lithium, and Indonesia, which does the same for nickel. China has built integrated supply chains from mining and processing of some critical minerals to manufacturing. This is the case for permanent magnets, which are used in wind turbines and EVs and are composed to a large extent of neodymium, an REE. In other cases, China imports ores and concentrates produced elsewhere for local processing and integration into domestic supply chains. For example, lithium is typically imported from Australia, refined and subsequently integrated into EV batteries for vehicles made domestically.

Some countries have increased their processing of critical minerals in line with extraction. This is the case with nickel in Indonesia, the mining and processing of which has increased significantly over the last decade in line with rising EV battery demand. The country was the world’s largest nickel miner in 2021 at nearly 40% of global output, having boosted extraction capacity twofold since 2012, and accounted for about 30% of global refined nickel production, up from just 1% in 2012. In contrast, the Democratic Republic of Congo produced less than 1% of refined cobalt although it accounted for over 70% of mining output.

In general, other steps along clean energy supply chains are more likely to experience bottlenecks than processing (see Chapter 1). However, there are exceptions. In the case of polysilicon production, bottlenecks are more likely at the processing stage, due to its complexity. Raw minerals must be of very high quality to yield metallurgical-grade silicon of above 98% purity, which then needs to undergo multiple refining steps to produce polycrystalline silicon with 99.9999% purity for solar PV applications. China currently controls about 70% of metallurgical-grade silicon production and 80% of the polysilicon production (USGS, 2022).

Figure 2.4 Regional shares of global production of selected critical materials, 2021

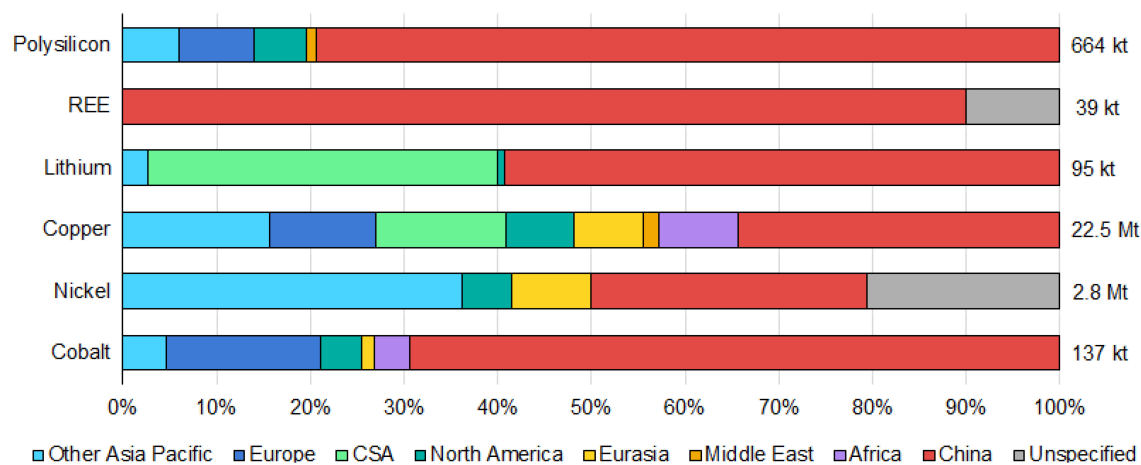

IEA. CC BY 4.0.

Sources: IEA analysis based on BNEF (2020); S&P Global (2022a); WBMS (2022); Adamas Intelligence (2020).

The concentration of the processing and refining of minerals is greater than that of extraction, with China dominating the processing of several of them.

Bulk materials production is highly concentrated as well

Clean energy technologies and infrastructure are made from large amounts of bulk materials, notably steel, cement, aluminium and plastics. Solar PV plants and wind farms generally require more bulk materials per unit of capacity than fossil fuel-based power plants, with some exceptions (also see Chapter 1). The raw materials

and fuels required for the production of bulk materials, including iron ore, limestone, bauxite, oil and natural gas, are widely available and there are few bottlenecks at present to increasing capacity in most parts of the world. Indeed, there is global overcapacity in the production of some bulk materials.

Bulk material needs vary enormously across energy end-use sectors. Steel and cement are vital for buildings and infrastructure, with demand generally highest in the emerging economies where economic development is fastest, notably China and Asia Pacific. Other end-use sectors, such as the manufacturing of consumer products, packaging, industrial and electrical equipment, and vehicles, also make use of large amounts of a wider range of bulk materials, including aluminium and plastics (Figure 2.5).

Figure 2.5 Estimated end-use shares of global consumption of selected bulk materials, 2021

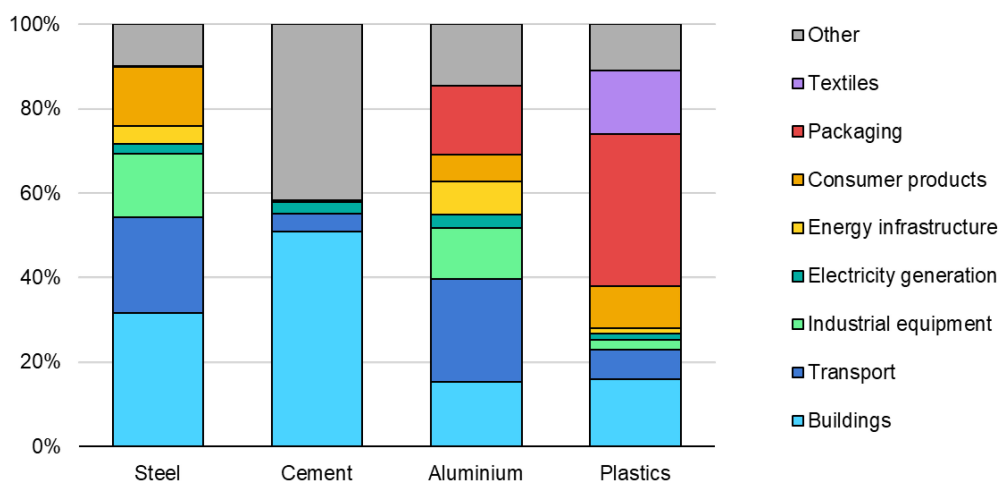

IEA. CC BY 4.0.

Notes: Energy infrastructure includes electricity grids and oil and gas pipelines. Industrial equipment does not include material demand from the plant shell. Transport includes vehicles and estimated material demand from road and rail infrastructure. Other includes non-energy infrastructure and miscellaneous uses.

Sources: IEA analysis based on Worldsteel (2022a); USGS (2022); IAI (2022); Platts (2022); Geyer, Jambeck & Law (2017).

Bulk materials are used in a diverse range of end uses, with the main drivers varying substantially by material.

Bulk materials production is relatively highly concentrated geographically, although not to the same extent as critical materials (Figure 2.6). China accounts for more than half of the world's production of crude steel, cement and alumina, and more than a quarter of primary chemical production. While some of this production is exported, China's development path has been especially material-intensive, with demand for cement and steel in particular being higher relative to the country's economic activity than in other major countries. Bulk materials are

generally less globally traded than critical materials, as a result of their wider global availability and higher costs of transportation relative to their value, encouraging production close to demand centres.

Figure 2.6 Regional shares in global production of bulk materials and intermediate commodities, 2021

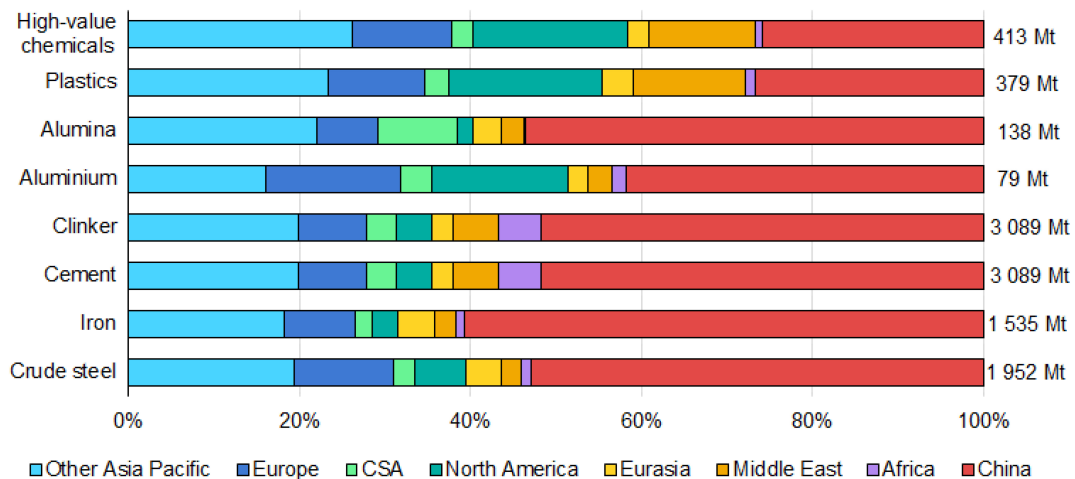

IEA. CC BY 4.0.

Notes: Plastics includes resin identifier codes 01-07, which excludes fibres. Iron includes pig iron and direct reduced iron. High-value chemicals include ethylene, propylene, benzene, toluene and mixed xylenes.

Sources: IEA analysis based on Worldsteel (2022a); USGS (2022); IAI (2022); Platts (2022); Geyer, Jambeck, & Law (2017).

China produces more than half of the world's crude steel and cement, and a large share of aluminium and primary chemicals, mostly for the domestic market.

Crude steel and iron

Steel is used in a wide range of end uses, with about half of demand coming from the buildings and transport sectors. Crude steel can be produced from scrap or iron, or more commonly a mixture of the two. Iron – made from iron ore – is virtually unlimited in its supply, whereas scrap availability is a function of past steel production and use. Countries with mature infrastructure and vehicle stocks tend to have ample domestic supplies of scrap, whereas emerging economies often need to produce more iron in order to increase their output of crude steel. Iron accounts for over 65% of the metallic inputs to crude steel production, with scrap accounting for the remainder. Globally, around 85% of available scrap is collected for recycling.

Around one-quarter of all the steel produced worldwide is traded internationally as intermediate steel products (finished and semi-finished), with the remainder being used by next-tier manufacturers in the country in which it was produced. The resulting products containing steel are also traded. Figures for the trade in volumes of steel contained in goods are much more uncertain; estimates from 2019 suggest that around 20% of this steel is exported, with almost 75% of the

steel contained in goods used in the countries where the goods are produced (Worldsteel, 2022a). Though China uses around 95% of its production domestically, it is the largest net exporter of steel at 43 Mt in 2021 – or a third of global net exports. The other leading net exporters are the Russian Federation (hereafter, “Russia”), Japan, Korea and India, while the leading net importers are the United States, the European Union, Southeast Asia and the Middle East.

Cement and clinker

Cement, the primary ingredient for making concrete, is generally produced close to the point of use due to the high cost of transport as a heavy material and the widespread availability of limestone as an input. About half of global cement production is used for constructing buildings and the remainder for making a wide variety of other types of infrastructure, including for clean energy. China is both the biggest consumer and producer of cement, producing around 2.4 Gt in 2021 and accounting for around 55% of global production, followed by India (8%), the European Union (4%) and the United States (2%). The expectation of rising demand for cement to meet new construction needs generally leads to investment in local production, reducing the need for costly imports.

Aluminium and alumina

The use of aluminium is relatively evenly distributed around the world and across economic sectors, with the transport sector accounting for about 25% of global demand, and construction and packaging each for about 15%. Aluminium is an important input to the clean energy transition, with the production of several clean technologies, including solar PV installations and EVs, requiring significant amounts. Electricity networks alone account for about 8% of aluminium demand today.

Like steel, aluminium can be produced from virgin mineral inputs (bauxite) or from scrap. Bauxite is first transformed into alumina (aluminium oxide), which undergoes electrolysis in a smelter to produce aluminium. Around one-third of aluminium was produced from scrap (excluding that generated during aluminium production) in 2021, of which 60% was end-of-life scrap, with the remainder being sourced from the manufacturing of aluminium products.

China is the largest producer of aluminium, accounting for over 40% of global production. The United States accounts for around 5% and Canada for around 6% of global production, mostly using scrap and imported alumina. Approximately 40% of aluminium is traded internationally, with exports led by Russia (net exports accounting for 11% of total exports), Canada and the United Arab Emirates (9% each), and India (8%). China produces 55% of the world’s alumina – an even larger share than aluminium, reflecting in part lower domestic scrap availability than that in many industrialised economies. Australia and Brazil are the world’s

largest alumina exporters, owing in part to their abundant bauxite reserves; together, they account for more than 20% of the world's alumina production, but just 4% of aluminium production.

Plastics and high value chemicals

The main thermoplastics – polyethylene, polypropylene, polyvinyl chloride, polyethylene terephthalate and polystyrene – are used primarily for packaging, which absorbs 36% of global supply, construction (16%), textiles (15%), automotive (7%) and consumer product (10%) applications. Some clean energy technologies make extensive use of plastics. For example, most wind turbine manufacturers use lightweight plastic composites to make blades, while solar panels often use various plastics to protect or connect some of the panels' parts.

Plastics are produced primarily from high-value chemicals – ethylene, propylene, benzene, toluene and mixed xylenes – which are in turn produced from oil products. Less than a fifth of plastic waste is currently collected for recycling, and less than a tenth of plastic production is based on post-consumer scrap material, reflecting the practical difficulties and cost of the recycling processes involved.

The geographic distribution of primary chemicals production reflects both regional demand and cost factors, especially the local availability and cost of oil feedstocks. Consequently, regions well-endowed with oil and gas resources, such as the Middle East and United States, are big producers. China is the world's leading producer of both high-value chemicals and key thermoplastics, accounting for around 25% of world output. The United States and Europe also hold strong positions in the global chemical and plastics industries, with the United States accounting for nearly 20% of combined production in these sectors and Europe for 10%. High-value chemical production and plastics production are generally located together. While plastic resins and derivative products are traded extensively, high-value chemicals are often gaseous (e.g. ethylene) and highly toxic (e.g. benzene), making transport cumbersome and expensive.

Technology manufacturing and installation

Technology manufacturing refers to the production of technologies using labour, tools and energy to transform materials into finished goods. In the case of the clean energy technologies covered in this report, these goods are categorised as follows:

- **Mass-manufactured technologies**, which are assembled in specialised factories in large volumes using several components and sub-assemblies, with the ready-to-use end product exiting the factory floor. Examples include solar PV modules, wind turbines components, EV batteries, fuel cells and fuel cell trucks, heat pumps, and electrolyzers.

- **Large-scale site-tailored technologies**, which are usually individually designed and sized to fit specific local conditions. Examples include most CCUS applications, synthetic hydrocarbon production and bioenergy-related technologies. These are effectively systems formed by components, some of which can be mass manufactured.

China dominates mass-manufactured clean technologies

China dominates the production of mass-manufactured technologies and components thanks to low manufacturing costs, a strong base in materials production and sustained policy support on these industry segments. It controls at least half of the output of most of the main such technologies, notably solar PV and EV batteries (Figure 2.7). The rest of the Asia Pacific region continues to manufacture technologies in which they hold strong intellectual property, such as batteries and fuel cells. As the markets for these technologies expand, capacity to produce these technologies can often exceed short-term production needs. Currently, manufacturing capacity exceeds production for most technologies in all regions, particularly electrolysers, EV batteries and fuel cell trucks (see respective sections below).

Solar PV and wind power

Solar PV and wind are the leading low-emission electricity generation technologies being deployed worldwide today. Over the last decade, China's dominance of manufacturing of solar PV equipment has grown, reducing the shares of Europe, Japan and the United States. Today, China's share in the manufacturing of silica-based solar PV modules exceeds 70% – almost double the country's share of global demand. The country is home to the world's top ten suppliers of solar PV manufacturing equipment. Asia Pacific (excluding China) hosts around one-fifth of module manufacturing, and the remaining capacity is located mostly in Europe and North America.

Manufacturing of wind turbines is also heavily concentrated geographically. The top 15 manufacturers accounted for almost 90% of the total capacity deployed in 2021. Among those, Chinese companies were the leaders, with more than 55% of the total, followed by European companies, with around 35%, and American ones, with less than 10%. The marketing strategies of these enterprises vary considerably across regions. In China, most of the wind farms that have been installed were built by Chinese manufacturers, accounting for more than 95% of the total capacity deployed domestically. European manufacturers have a much more international business, installing around 65% of their output in other regions, where they have built local manufacturing facilities.

Figure 2.7 Regional shares of manufacturing capacity for selected mass-manufactured clean energy technologies and components, 2021

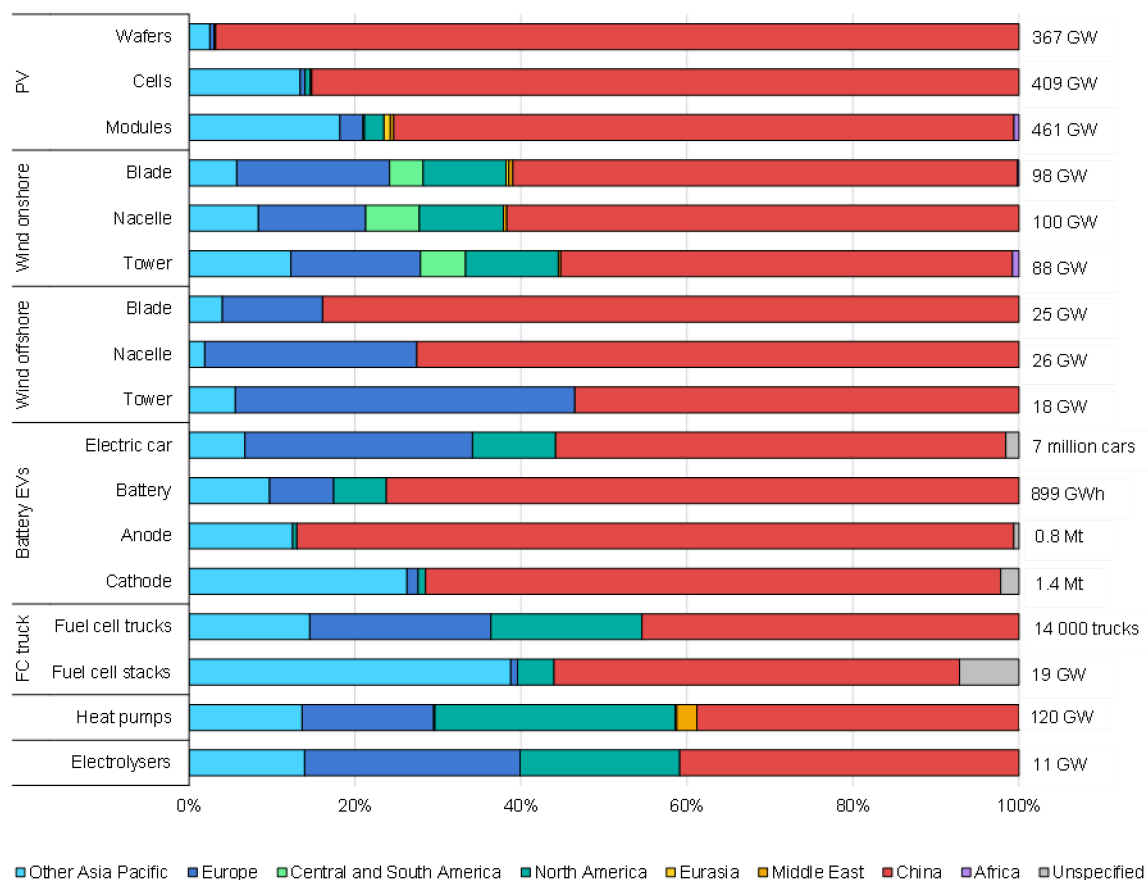

IEA. CC BY 4.0.

Notes: FC = fuel cell. Heat pumps capacity refers to thermal output.

Sources: IEA analysis based on InfoLink (2022); BNEF (2022); BNEF (2021b); Benchmark Mineral Intelligence (2022); GRV (2022); UN (2022a); Wood Mackenzie (2022).

Around 90% of mass-manufacturing capacity for several key clean energy technologies is concentrated in China and the Asia Pacific region.

EV batteries

The market for EVs is booming. Sales of EVs nearly doubled to 6.6 million in 2021 and exceeded 10 million sales in 2022. Of these, most were full battery EVs, accounting for over 70% of EVs sold, with the rest being plug-in hybrids.

EV manufacturing has certain synergies with other sectors, most obviously with the conventional internal combustion engine (ICE) vehicle industry. Though the production of EVs involves the manufacturing of specialty components not used for making ICE vehicles, with the battery being the most critical component. The rapid increase in EV sales and, more recently, Russia’s invasion of Ukraine, have

tested the resilience of battery supply chains, though output has to date managed to keep pace with demand. Global demand for automotive Li-ion batteries doubled to 340 GWh in 2021.

China dominates production at every stage of the EV battery supply chain, with the exception of the mining of metals needed to make cathode materials. Two-thirds of global battery cell production, as well as around 80% of the production of cathode and over 90% of anode material, is in China. Europe is responsible for over a quarter of EV production, but holds very little of the rest of the supply chain apart from cobalt processing, in which it has a share of around 16% (mostly in Belgium and Finland). The United States has a smaller stake in the global EV battery supply chain, with only around 10% of EV and battery production capacity. Both Korea and Japan have considerable shares of the supply chain downstream of raw material processing, particularly in cathode and anode material production. Korea holds 13% of global cathode and 3% of anode material production capacity while Japan accounts for 14% (cathode) and 10% (anode).

Both EVs and their batteries tend to be produced close to where they are sold. Only China exports significant amounts of both EVs and batteries over long distances. The top five battery manufacturers, headquartered in Korea, China or Japan, hold over 50% of global manufacturing capacity, with China's CATL – Contemporary Amperex Technology Co. Limited, the market leader – alone holding around 15%. EV battery production capacity currently exceeds demand, as factories have generally been deliberately oversized in anticipation of continuing strong growth in demand. In addition, some factories are still ramping up production to reach nameplate capacity, a process that can take from three to six years (Fleischmann et al., 2021). Overcapacity is nonetheless starting to fall: the global average utilisation rate for all types of battery factories was 43% of capacity in 2021, up from 33% in 2020.

Fuel cell trucks

Almost 900 heavy-duty fuel cell trucks⁹ were sold worldwide in 2021, 90% of them in China. Switzerland was the second-largest market, with around 8% of sales. The production of fuel cell trucks involves the manufacturing of some specialty components not used for making conventional diesel-based ICE trucks. They include the hydrogen tanks for on-board storage and the fuel cell system. Currently, global fuel cell truck manufacturers' claimed nameplate capacity aggregates to over 13 000 trucks/year, implying significant idle capacity and

⁹ Heavy-duty refers to trucks with a gross vehicle weight over 15 tonnes. We focus on this specific vehicle segment as it is the vehicle category that is projected to have the largest share of fuel cell vehicles in the Net Zero Emissions by 2050 Scenario. The global fleet of battery electric heavy-duty trucks was more than an order of magnitude bigger than that of fuel cell trucks in 2021. The former is projected to remain the dominant zero-emission powertrain in that scenario.

enormous potential to increase near-term deployment with existing facilities concentrated in China, Korea, the United States and Europe.

The leading manufacturers of trucks are China's SAIC Hongyan, which can manufacture around 3 000 trucks/year, Korea's Hyundai (2 000 trucks/year), and the American companies Hyzon Motors (1 000 trucks/year in the Netherlands) and Nikola (2 500 trucks/year in the United States and 2 000 trucks/year in Germany). Many other established manufacturers are also well positioned to begin production of fuel cell trucks in the near future given the short lead times involved in retooling existing assembly plants and the large share of components common to fuel cell, battery electric and ICE trucks. Several fuel cell suppliers are collaborating with truck manufacturers, for example, Cummins with Daimler in the United States and Scania in Europe; Kenworth with Toyota in the United States under a long-standing deal; and Weichai Power and Sinotruck in China. All these manufacturers could quickly ramp-up production by leveraging their substantial existing capacity and supply chains.

Fuel cell trucks typically rely on proton-exchange membrane (PEM) technology that converts hydrogen to electricity, which is used to power the electric motor and charge the vehicle's battery. PEM fuel cell manufacturing capacity for all vehicles, including cars, vans, trucks and forklifts, totalled over 290 000 systems/year in 2021 and is thought to have reached over 330 000 systems/year in 2022. Around 65% of capacity in 2021 was in China, where the leading producers are Refire, SinoSynergy, Weichai and Wuhan HydraV Fuel Cell Technologies. Korea has over 15% of capacity, with Hyundai the largest manufacturer.

There is substantial existing manufacturing capacity for high-pressure on-board vehicle hydrogen storage tanks. The leading manufacturers have taken advantage of the knowledge and experience gained with other compressed gas storage, in particular natural gas. Many also supply equipment for hydrogen distribution via tube trailers and for stationary hydrogen storage such as at refuelling stations. High-pressure storage vessel manufacturing is already well-established in North America, Europe and Asia. A number of manufacturers of this type of equipment have either already entered the market for on-board hydrogen storage for heavy-duty vehicles or plan to do so. Luxfer, which has factories in Canada, China, the United Kingdom and the United States, provided tanks for the Hyundai heavy-duty trucks sold recently in Switzerland. Hexagon Purus, which has manufacturing facilities in Canada, Germany and the United States, has a contract to provide on-board storage tanks to Nikola. Toyota currently manufactures its own tanks and is also positioning itself as a supplier to other manufacturers.

Heat pumps

More than 1 000 gigawatts thermal (GW_{th}) of heat pump capacity was in operation in buildings worldwide at the end of 2021, meeting around 10% of the total building

heating needs. Global heat pump sales increased by about 13% in 2021. The market grew quickest in the European Union, where sales rose 35%, the United States (15%), Japan (13%) and China (13% for air-source heat pumps). Air-source heat pumps (air-air and air-water) account for the majority of heat pump sales worldwide, making up over 80% of the market in 2021.

Global heat pump manufacturing capacity (excluding air conditioners) amounted to around 120 GW_{th} at the end of 2021. Manufacturing is dominated by China, with almost 40% of total capacity, North America (30%), Europe (15%) and other Asia Pacific (over 10%). While China and other Asia Pacific dominate the global heat pump market, in particular for split systems (with both indoor and outdoor units connected by a set of pipes), Europe is the leader in the market for hydronic systems (whereby heat is conveyed via hot water) and large-scale applications. The top four global manufacturers accounted for around 40% of total capacity in 2021.

Heat pump manufacturers mostly serve the local market, with only China exporting significant numbers of heat pumps. Several heat pump components such as fans, pumps, tanks, expansion valves, heat exchangers and compressors are also common to other heating equipment or other industries. In particular, space heating and water heating heat pumps share the same type of components with air-conditioning units and refrigerators, which makes the total demand for components of the refrigeration cycle much larger than the one from heat pumps alone. Nonetheless, these components are not always interchangeable across equipment. Their production is currently dominated by a small number of companies.

Some of the main heat pump manufacturers also make heat pump components such as heat pump compressors, which currently make up about one-quarter of the cost of a heat pump, and fans. Mitsubishi, Carrier and Daikin, which together accounted for over 30% of all the heat pumps produced in 2021, already produce their own compressors. While compressors are needed in many industries, the design and manufacturing of such a component is a specialised industry and some heat pump compressors might require specific designs for certain temperature ranges and refrigerants. The market is currently dominated by a few suppliers. Europe imports a large share of the compressors it needs to make air-air heat pumps, whereas the compressors it needs for air-water and ground-source heat pumps are typically manufactured within the region by companies such as Danfoss, Bitzer and Emerson Copeland (Lyons et al., 2022).

The global heat pump industry is facing some bottlenecks amid rapid growth, in part due to limited supplies of semiconductors, which are used in control panels, electric pumps and fans. However, some manufacturers in the heat pump industry are confident that current shortages can be overcome within the next 12-18

months. If components become available, there may be potential to increase output at existing facilities by roughly 20%.¹⁰ In some cases, there is also potential for assembly lines to switch between producing air conditioners and heat pumps, which use similar technology (reversible heat pumps can produce both heat and provide cooling). The scope for raising production at short notice varies among manufacturers. Some, particularly in Europe, are already operating at rates close to maximum capacity.

The manufacture of refrigerants used in heat pumps is concentrated in China and North America, with the former being the largest exporter (CEMAC, 2020; United Kingdom, Department for Business, Energy & Industrial Strategy, 2020). The location of manufacturing sites is driven primarily by the proximity of chemical feedstock and the availability of a cheap and specialised labour force. Key refrigerant manufacturers include Honeywell International and Chemours Company in the United States, Dongyue Group and Sinochem Group in China, and Daikin in Japan. Heat pumping technologies predominantly rely on hydrofluorocarbon refrigerants such as R410A, but the share of others with lower global warming potentials (GWPs), such as R32, and natural refrigerants (such as propane) is rapidly increasing (BSRIA, 2020).

Electrolysers

Technologies to produce low-emission hydrogen today include water electrolysis and fossil-based hydrogen with carbon capture and storage (CCS), generally using natural gas as the feedstock (see below). Water electrolysers, which can be mass produced, are currently based on a small number of technologies, including alkaline, polymer electrolyte membrane, solid oxide electrolyser cell (SOEC) and anion exchange membrane (AEM). Alkaline technologies dominate the market today, though polymer electrolyte membrane ones are also commercially available. SOEC and AEM electrolysers are under demonstration, with the former at a large scale, and are expected to be commercialised soon.

Alkaline electrolysers are extensively deployed in the chlor-alkali industry, which accounts for the majority of the current global installed electrolyser capacity of more than 20 GW. However, this capacity is dedicated to the production of chlorine, with hydrogen being a by-product of the process. Only around 500 MW of electrolysers had been deployed globally for the dedicated production of hydrogen as of the end of 2021, producing around 35 kt that year. There is a growing number of projects under development though and, if all were realised, global installed electrolyser capacity could reach 134 GW in 2030,¹¹ with Europe,

¹⁰ IEA analysis based on research, industry consultation and data from Global Research View.

¹¹ This would increase to 240 GW if projects at very early stages of development (i.e. where only a co-operation agreement among stakeholders has been announced) are included.

Australia and Latin America accounting for nearly three-quarters of this capacity. Alkaline electrolysers are technologically less sophisticated and do not require expensive catalysts, though their operation is less flexible than polymer electrolyte membrane or AEM ones and are less efficient than SOEC ones. They can, nonetheless, provide enough flexibility to deal with intermittent renewables and provide primary grid services (Thyssenkrupp, 2020).

Electrolyser manufacturing capacity worldwide today amounts to around 10 GW per year, which is much larger than current annual deployment (IEA, 2022a). This spare capacity would be more than sufficient to meet relatively small increases in demand in the near term. Larger increases in line with government climate targets and announced industrial plans for electrolysis-based production of hydrogen would require new manufacturing capacity. Electrolyser components can be produced on a large scale and easily distributed globally to facilities where electrolyser systems are assembled and sold locally. Transporting the whole electrolyser over long distances is costly and difficult, as they are bulky.

Electrolysers are currently manufactured mostly in China, which holds over 40% of global capacity, and in Europe, at 25%. The rest are made in North America, Japan and India. There are a number of companies active in the sector, including Thyssenkrupp Nucera, PERIC, John Cockerill and Nel Hydrogen. Chinese manufacturers have, on average, larger manufacturing capacities per plant than those in Europe. China is currently the leader in alkaline electrolysers thanks to cheaper materials and labour than in Europe.

Large-scale site-tailored technologies could exploit synergies

Large-scale site-tailored technologies are set to benefit from extensive synergies with other industries, especially oil and gas, that have well-established supply chains. For now, their deployment has been concentrated in a few regions only, so supply chains are relatively under-developed, in contrast to mass-manufactured technologies (Figure 2.8). In Europe, a number of policies have been put in place to encourage the take-up of clean energy technologies, favouring deployment of emerging technologies with limited international trading, such as electrolysers and DAC plants. The United States is well-placed to build large-scale facilities thanks to a favourable policy environment and extensive infrastructure. This should support the deployment of emerging clean energy supply chains, including for the production of low-emission hydrogen and low-emission synthetic hydrocarbon fuels.

Figure 2.8 Regional shares in global installed operating capacity of selected large-scale site-tailored clean energy technologies, 2021

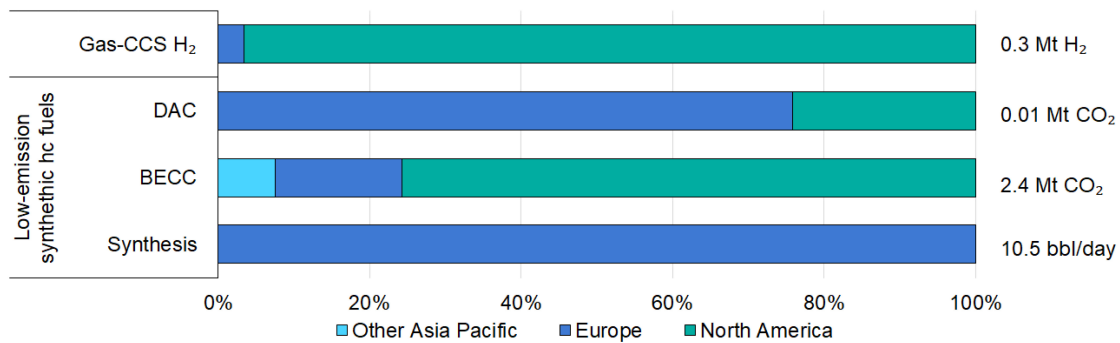

IEA. CC BY 4.0.

Notes: DAC = direct air capture; BECC = bioenergy with carbon capture; Gas-CCS H₂ = natural gas-based hydrogen production with CCS; hc = hydrocarbon; bbl = barrel. Shares are based on nominal capacity. Synthesis refers to low-emission synthetic hydrocarbon fuels production.

Sources: IEA analysis based on company announcements.

The capacity of large-scale site-tailored clean energy technologies is almost entirely concentrated in Europe and North America.

Low-emission hydrogen: Natural gas-based hydrogen with CCS

Low-emission hydrogen can be produced using natural gas or biomass as the feedstock in conjunction with CCS, in addition to water electrolysis. Steam methane reforming (SMR) is currently the dominant technology for gas-based production of hydrogen, though autothermal reforming, which leads to higher efficiencies and, when combined with CCUS, higher capture rates, is expected to gain market share in the future.¹² Partial electrification of the SMR process could also help cut combustion emissions, leaving only the concentrated process flux of CO₂ to capture. Around 0.1% of the dedicated global hydrogen production of nearly 94 Mt in 2021 came from water electrolysis, but its market share could increase in the future with lower renewable electricity and electrolyser costs.

Although only a few SMR with CCUS plants are in operation today, there is considerable experience in building and operating them, and strong synergies with the oil and gas sector, characterised by well-established supply chains for components and a skilled labour force. At present, there are six such plants operating around the world, with a total installed production capacity of around 0.3 Mt of hydrogen, all of them in North America (in refineries and fertiliser

¹² In an SMR process, natural gas is transformed into syngas in a reformer, which is then converted into a hydrogen-rich mixture in a water-gas shift (WGS) reactor, from which high-purity hydrogen can be obtained. Roughly 60% of the process CO₂ comes from natural gas oxidation in the reformer and WGS reactor in a high concentration stream, which can be captured relatively easily, while the rest is emitted from the reformer furnace, in a lower concentration flue gas stream.

factories equipped with CCUS as early as the 1980s).¹³ While over 95% of the CO₂ emitted during hydrogen production can be captured, most capture units were installed to capture only process emissions, which make up roughly 60% of total plant emissions.

Low-emission synthetic hydrocarbon fuels

Low-emission synthetic hydrocarbon fuels can displace fossil-based fuels for applications where alternative carbon mitigation options are not technically or commercially available. Synthetic hydrocarbon fuels are made from synthesis gas (primarily a mixture of hydrogen, carbon monoxide and CO₂) using catalysts. Suitable feedstocks include electrolytic hydrogen and atmospheric CO₂, captured directly through DAC or indirectly through BECC. Depending on the choice of catalyst and process conditions, various fuels can be produced from synthesis gas.

The production capacity for low-emission synthetic hydrocarbon fuels is extremely limited today, with only three pilot projects in Europe. Although CO₂ can also be captured from concentrated sources such as industrial and power plants, using such CO₂ for synthetic hydrocarbon fuels production would eventually increase the total amount of CO₂ in the atmosphere. In a net zero energy system, CO₂ will need to come from DAC or BECC plants.

DAC and BECC plants are currently assembled and built by just a few companies based in Europe and North America. These companies either build and operate their own plants, or licence their intellectual property to project developers who are in charge of manufacturing, assembling, building and commissioning the plant. Given the small number of players, there is no established trade route but rather partnerships between suppliers and project developers. Some components of both DAC and BECC plants such as separation columns, CO₂ compressors and heat exchangers, which are used in oil refining and other industrial sectors, are currently mass manufactured and widely traded at the international level.

Around 2.5 Mt of biogenic CO₂ per year is currently being captured annually around the world, more than 90% of it from bioethanol plants. Around half of the captured gas is used, mainly in the food and beverage industry and for enhanced oil recovery, while the other half is stored underground in dedicated facilities. BECC plants are concentrated in the United States, though some smaller-scale plants operate in Europe and Japan. Most of the 17 DAC plants in operation are young – around five years old on average – and very small: the largest operating

¹³ The Al Reyadah steel mill in Abu Dhabi, which features CO₂ capture from gas reforming and direct iron reduction, is also considered (inherent) low-emissions hydrogen production under IEA definitions, but is excluded here as not strictly SMR with CCUS.

plant has a nominal capture capacity of just 4 000 tonnes of CO₂/year. Global DAC capture capacity amounts to around 8 000 tonnes of CO₂/year.

Synthetic hydrocarbon fuel production currently relies on the methanol-to-gasoline or Fischer-Tropsch (FT) process, both of which are well-established technologies. While up to 800 PJ/year of fossil-based FT synthesis has been deployed to date, only around 0.02 PJ/year (11 bbl/day) of this is low emissions. This includes three pilot projects in Europe – two in Germany (Atmosfair and Kopernikus projects) and one in France (Methycentre project) – that use CO₂ sourced from biogas upgrading or DAC.

Only one company – Germany's INERATEC GmbH – is currently manufacturing the reactors needed for those pilot FT plants. Large-scale, fossil-based FT plants and their manufacturing are currently concentrated in the Middle East, China and South Africa. These plants have been commissioned and operated by a few large engineering and oil and gas companies, including Sasol, Shell and Synfuels China. Some of the components and competences could be easily transferred from fossil-based applications to low-emission ones.

Low-emission FT plants would make use of the same catalysts – a key component in the synthesis process – that are used today in fossil-based applications. They are heavily reliant on critical materials, including cobalt, rhodium, ruthenium, platinum and palladium. They have been produced on a large scale for decades, so the needs of new low-emission plants could take advantage of existing supply chains. A few of the top catalyst producers, including Clariant, Axens and Velocys, are actively involved in low-emission FT projects. The geographical distribution of these and other top catalyst manufacturers mirror that of the small-scale FT manufacturers, with activity concentrated in Europe and the United States.

International trade in minerals, materials and energy technologies

Shifting from a fossil fuel-based energy economy to one that provides the raw materials needed to make clean energy technologies and related infrastructure involves a major change in trade flows among the different steps of their supply chains. The leading producing countries of materials, and manufacturers of equipment and components for clean energy technologies, generally differ markedly from the main fossil fuel producers.

Vulnerabilities associated with the geographical concentration of production and manufacturing facilities will undoubtedly persist for many commodities and technologies, especially for those with long lead times, and despite efforts to develop domestic capacity and diversify sources of supply. This could lead to bottlenecks, disruptions in supply and delays in deploying some clean energy

technologies. The way international trade policy and tariffs play out will be a crucial factor in determining the pace at which clean energy transitions advance.

Critical minerals are heavily traded regionally

Critical minerals are currently the most heavily traded inputs to clean energy supply chains, driven by trade in lithium and cobalt. For these minerals, the share of inter-regional trade in total production¹⁴ is around 40% higher than that of bulk materials and 150% higher than that of fossil energy (Figure 2.9). The degree to which critical minerals are traded varies according to their geographical distribution. For example, about four-fifths of cobalt production and just under half of that of lithium are traded across regions, as ores are often refined in China, even if extracted elsewhere. The share of output that is traded is lower for nickel ore and copper ore, around 40%, as a bigger share of these minerals is refined in the region where it is extracted. The share of trade in the production of critical materials (e.g. lithium carbonate, refined copper) is generally lower. Polysilicon is also relatively less traded across regions, notably due to China's dominant position in polysilicon production and use.

The share of inter-regional trade is less pronounced for bulk materials required in clean energy supply chains and infrastructure, typically averaging 25-40%. Aluminium and plastics are at the higher end of this range, as the location of aluminium production is usually determined by access to cheap electricity and that of plastics to cheap oil and gas. Further down the supply chain, final clean energy technologies and products – with the notable exception of solar PV modules – are less heavily traded.

¹⁴ The share of trade is calculated as the sum of trade (the average of total exports and total imports) divided by global production.

Figure 2.9 Share of inter-regional trade in global production for selected minerals, materials and technologies, 2021

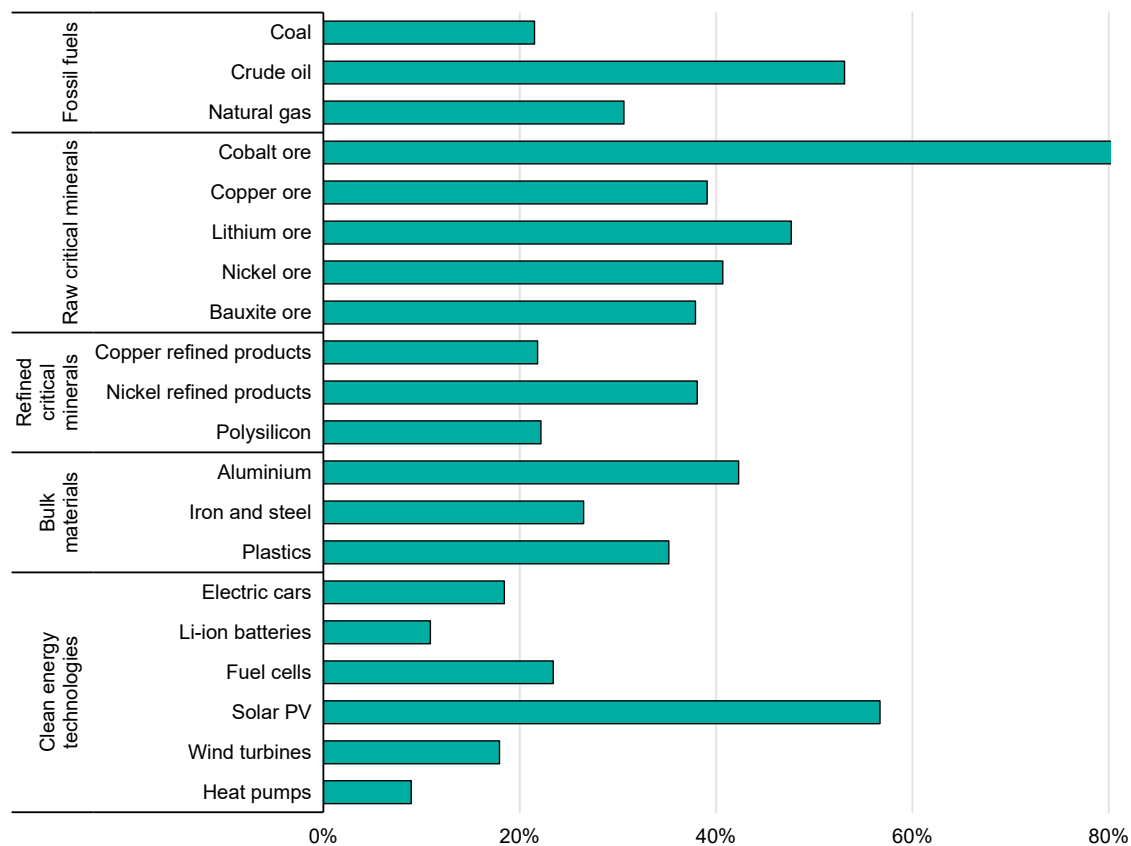

IEA. CC BY 4.0.

Note: Data are for 2020 for coal, oil, gas. The share is calculated as the sum of trade to and from Africa, Asia Pacific, Central and South America, China, Eurasia, Europe, Japan, Korea, the Middle East, and North America divided by global production.

Sources: IEA analysis based on WBMS (2022); S&P Global (2022a); USGS (2022); Worldsteel (2022b); IEA (2021a); IEA (2022b); IEA (2022c); UN (2022a); BNEF (2021c); E4tech (2022).

Critical minerals are generally traded across regions more than critical and bulk materials, clean energy technology equipment and products, and fossil energy.

For mature and established supply chains of all types, governments and industry typically handle the risks associated with geographical concentration by establishing dedicated mechanisms to minimise the impacts of potential disruptions and increase diversity of supplies. Many clean energy technology supply chains are new and evolving rapidly, so can be more vulnerable to high geographical concentration. For instance, for three (batteries, wind, solar PV) out of the ten clean energy technologies analysed in this report, over 70% of the manufacturing capacity is located in China, and over 35% for another three technologies. In addition to the energy security benefits of greater diversity, there is a huge economic opportunity to be grasped by countries and industry by investing in the supply chains of new and emerging clean energy technologies.

Figure 2.10 Trade balance along supply chains in selected countries/regions, 2021

		China	Europe	United States	Japan	Korea
Energy technology	Li-ion batteries	13%	-30%	-7%	27%	-14%
	Electric cars	8%	-27%	3%	76%	58%
	Fuel cells – mobility	5%	-92%	-4%	61%	8%
	Electrolysers	0%	0%	0%	0%	0%
	Solar PV – modules	52%	-100%	-65%	-92%	45%
	Wind turbines	14%	6%	-38%	-46%	80%
	Heat pumps	14%	-25%	2%	17%	8%
Critical minerals	Lithium ore	-75%	0%	-100%	0%	0%
	Cobalt ore	-98%	-100%	100%	-100%	0%
	Nickel ore	-88%	-66%	100%	-100%	-100%
	Copper ore	-80%	-40%	30%	-100%	-100%
	Nickel refined products	-51%	-22%	-100%	23%	-58%
	Copper refined products	-25%	-11%	-45%	41%	-1%
	Solar PV – polysilicon	-54%	37%	17%	40%	64%
Fossil energy	Coal	-8%	-43%	15%	-100%	-99%
	Oil	-78%	-72%	-18%	-97%	-100%
	Natural gas	-41%	-57%	9%	-98%	-98%
Bulk materials	Iron and steel	5%	2%	-24%	31%	17%
	Plastics	-21%	-10%	21%	6%	44%
	Aluminium	-7%	-53%	-80%	-100%	-100%
Averages	<i>Energy technology average</i>	15%	-38%	-16%	6%	26%
	<i>Critical minerals average</i>	-85%	-52%	33%	-75%	-50%
	<i>Refined critical minerals average</i>	-43%	1%	-43%	35%	2%
	<i>Energy (fossil) average</i>	-42%	-57%	2%	-98%	-99%
	<i>Bulk materials average</i>	-8%	-20%	-28%	-21%	-13%

IEA. CC BY 4.0.

Notes: Trade balance is the volume of net exports divided by production in each region for the net exporters (positive) or imports divided by consumption in each region for the net importers (negative). Dark red indicates a higher share of imports in total consumption, while light red indicates a smaller share. Blue is for exports with darker shades indicating a higher share of exports over total production. The analysis is based on physical units, not monetary trade flows. Due to data availability, monetary flows are used for heat pumps and wind turbines.

Sources: IEA analysis based on WBMS (2022); IEA (2021a); IEA (2022b); IEA (2022c); IEA (2022d); USGS (2022); Worldsteel (2022b); UN (2022a); BNEF (2021c); E4tech (2022); Thomson Reuters (2022); OICA (2022).

China, Japan and Korea are major net exporters of most clean energy technologies but importers of critical mineral ore to meet their needs.

China's dominance in supply chains today is not a coincidence. Its clean energy technology industry has been over a decade in the making, driven by industrial policy focused on several key technologies. China is a key net global exporter of many clean energy technologies, notably solar PV modules, exporting over half of its output (Figure 2.10). China accounts for 25% of the inter-regional exports of EVs and over 80% of Li-ion batteries, mostly going to Europe and other Asian countries, though most of the country's output of these goods goes to the domestic market. China is close to being self-sufficient in bulk materials and exports a significant share of steel. However, China is a large importer of other materials

and products such as some critical minerals, fossil fuels, polysilicon and critical materials such as nickel (mainly from Indonesia).

Europe is a big importer of clean energy technologies such as EVs, batteries, fuel cells and solar PV (it imports nearly all its solar panels), but is a net exporter of wind turbine components (accounting for a quarter of inter-regional exports). It imports large volumes of materials such as aluminium and, to a lesser extent, plastic, while it exports polysilicon (accounting for nearly half of exports). It imports most of its minerals and fossil fuels, except those for which it has no processing capacity at present, such as lithium.

The **United States** is a small net importer of most clean energy technologies. The share of imports in meeting domestic demand are highest for solar PV, at around two-thirds of domestic demand. Thanks mainly to Tesla, the United States is a net exporter of EVs, and accounts for nearly 20% of total inter-regional exports. The United States is a major net importer of refined critical minerals and aluminium, but imports almost no raw critical mineral as it has very little refining capacity. By contrast, it is a net exporter of fossil fuels with the exception of crude oil,¹⁵ as well as plastics (US EIA, 2022).

Japan exports more than half of its production of EVs (although overall volumes are small). It accounts for 80% of total exports of fuel cells, mainly passenger cars. By contrast, it relies mainly on imports for solar PV modules. **Korea** is a net importer of EV batteries, entirely from China, but is a net exporter of EVs and solar PV panels. Together, Japan and Korea represent over a quarter of the global trade of EVs (China makes up for another quarter) and dominate the nascent export market in fuel cell vehicles. Both countries import the vast majority of the minerals and fossil fuels they consume.

Policy has been key to the boom in EV trade

The position of countries and industries in the supply chains of new and emerging technologies depends on a variety of factors, ranging from the access to resources to the cost of production and the skills available in the domestic workforce. Industrial policy and planning is another key driver. The recent evolution of global trade in Li-ion batteries and EVs (Figure 2.11) provides a useful case study of how industrial, climate and energy policies can work together to spur the development of new industries along clean technology supply chains.

¹⁵ In terms of total petroleum, the United States is a net exporter since 2020 for the first time since 1949.

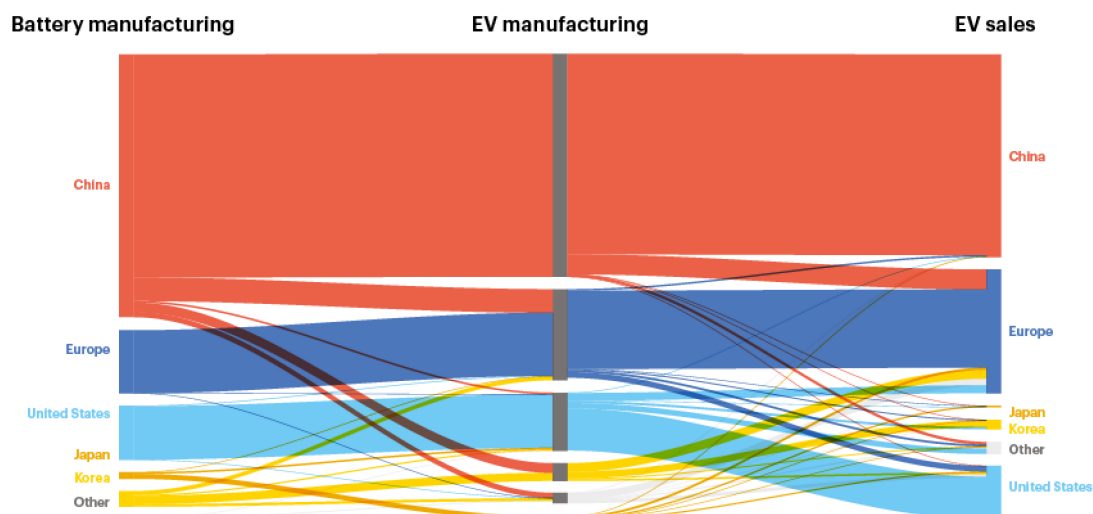
Figure 2.11 Global trade flows of lithium-ion batteries and electric vehicles, 2021

IEA. CC BY 4.0.

Notes: Unit: GWh. Flows represent battery packs produced and sold as EVs.

Sources: IEA analysis based on EV Volumes from Benchmark Mineral Intelligence and company announcements.

China is the leading exporter of both EVs and their batteries, sold primarily to Europe, while the United States is largely self-sufficient in both.

China has a towering presence in global EV and battery markets, supplying both domestic and international markets. Europe is the main trade partner: nearly 25% of the batteries used in EV production in Europe come from China, and more than 15% of the batteries embedded in EVs sold in Europe as well. China's EV industry has developed quickly in the last decade thanks to sustained policy support such as domestic EV purchase incentives in place since 2009. These schemes officially opened up nationwide in 2013 and were expanded in 2014 with the introduction of tax exemptions for EV consumers (Government of China, 2013; 2014). In response to weaker than expected demand, both measures were extended several times. Domestic electric car sales grew from around 15 000 in 2013 to around 220 000 in 2015, making China the largest EV market in the world ever since. Sales reached around 6.4 million in 2022.

The focus of China's EV policy on domestic sales has attracted international car manufacturers to produce models there. Around 20% of all the electric cars sold in China in 2021 were made by foreign carmakers. Because EV production costs in China are relatively low, those carmakers, as well as domestic ones, also export part of their Chinese output. For example, around 60% of the EVs sold in Europe and imported from China were manufactured by international carmakers such as Tesla (Figure 2.12).

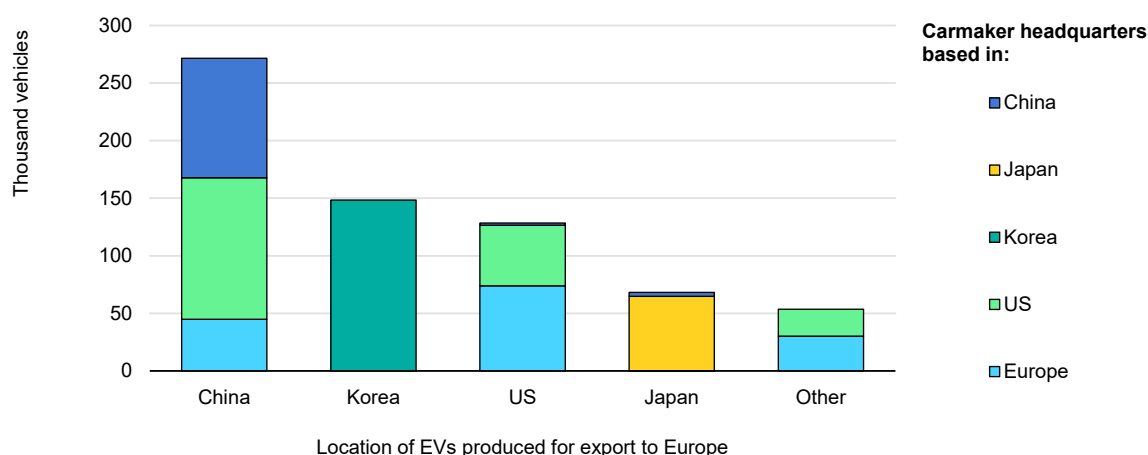
Figure 2.12 EV imports to Europe by country of production and manufacturer, 2021

IEA. CC BY 4.0.

Source: IEA analysis based on EV Volumes (2022).

Europe imports 40% of its EVs from China. Overall, most imports are manufactured by carmakers headquartered in the United States (30%), Europe and Korea (20% each).

The expansion of battery manufacturing capacity to supply the EV industry has also been a strategic priority in China. In 2015, China's Ministry of Industry and Information Technology (MIIT) released the Automotive Power Battery Industry Normative Conditions, aiming to encourage EV battery development and regulate the industry (China, MIIT, 2015). From 2015 to 2016, MIIT released four lists of companies that met these conditions, the last one with 57 companies, all of which were Chinese. Since EVs on sale in China need to be equipped with batteries from the listed companies in order to receive government subsidies, this policy favoured the growth of domestic companies. This helped to create global giants such as CATL, which is now the world's largest battery maker. In 2019, MIIT officially announced the abolition of the company lists, which has brought back competition from foreign companies (China MIIT, 2019). In 2021, China held 75% of global EV battery manufacturing capacity, which, at 685 GWh, was significantly higher than annual battery demand of 210 GWh.

China also has high trade tariffs, of 40%, for battery-related goods imported in the country, which encourages domestic production. Before 2013, China already held large shares of the global refining of battery metals, notably lithium and cobalt, as well as manufacturing of anodes and cathodes, thanks to its large battery industry to supply consumer electronics. These industries have boomed with the rising EV demand, leading many traditional foreign battery makers from Korea and Japan to invest in China. LG built its first battery factory in China in 2014, while Panasonic opened one in 2017. Existing supply chains and China's strong manufacturing base facilitated the rapid expansion of these production facilities.

In the **European Union**, strategic industrial policy on batteries began much later. In 2017, the European Commission set up the European Union Battery Alliance –

a public-private organisation tasked with co-ordinating European industrial players to spur investments in the battery industry – which resulted in the 2018 Strategic Action Plan for batteries. This work was followed by the implementation of Important Projects of Common European Interest (IPCEI), through which European countries could provide public subsidies to co-finance the development of a domestic battery industry. The first IPCEI, worth EUR 3.2 billion (USD 3.8 billion), was announced in 2019 and a second one worth EUR 2.9 billion (USD 3.4 billion) was announced in 2021, financing a range of projects from raw material extraction to battery recycling.

The new EU industrial strategy for domestic battery production, alongside clear policies on cutting CO₂ emissions from road transport and an increasingly supportive investment environment, has led to large investments in the battery industry in Europe, though no large plant has yet come online. Nonetheless, battery production capacity in the European Union could reach nearly 500 GWh by 2026, compared with around 35 GWh in 2020 (Beermand and Vorholt, 2022). Unlike for battery manufacturing, battery component factories have not received as much investment, meaning that Europe is likely to continue importing those components for a longer time. In response to an absence of domestic production, the European Union decided in 2020 to reduce tariffs on batteries and battery components to increase the availability of EVs on the market, as the domestic supply chain would have not been able to satisfy the rapid growth needed to meet climate targets (EU, 2020).

The **United States** began prioritising battery manufacturing with the post-financial crisis American Recovery and Reinvestment Act of 2009 (US DOE, 2009), which made available USD 2 billion (nominal value) in grants for battery and component manufacturing. This led to the construction of some of the large battery factories in operation today, such as LG's factory in Michigan and AESC's factory in Tennessee. It also provided a low-interest loan to Tesla, which resulted in the construction of the country's largest battery factory in Nevada, commissioned in 2016. During the Trump administration, the United States increased tariffs on a list of goods made in China, including batteries and most other components, to 7.5-25%.

The Inflation Reduction Act (IRA), adopted in 2022, redefined the US clean energy industrial strategy. It includes provisions for production subsidies for battery and battery component manufacturing and, importantly, limits EV purchase incentives to domestically produced models. It is expected to stimulate major new investments in the coming months and years. However, the IRA also discourages importing components manufactured in countries that do not have a trade agreement with the United States, which could slow the expansion of EV production and sales in the near term given the relative limited possibilities for quickly boosting domestic production of some components.

Policy support has boosted trade in other clean energy supply chains

Developing a supply chain for clean energy technologies is a lengthy process. More than a decade of policy support was needed to develop China's dominant place in the current global EV battery industry, which benefited from a strong base in the form of a well-established consumer electronics battery industry and a strong policy push. The process was similar for China's solar PV industry, with policy support dating back to the 10th Five-Year Plan in 2001. Today, China is by far the largest global supplier at each step of the global solar PV supply chain; at around 340 GW/year, its manufacturing capacity for PV modules alone is more than twice the global PV module installations, with manufacturing capacity utilisation rates for solar components ranging from 40-50% in 2021 (Figure 2.13). China directly supplies all markets except North America, where the United States has imposed import tariffs on solar PV elements from China. Chinese companies, however, have been actively investing in production capacity in Southeast Asia for supplying the region and exporting to the United States, as these countries are not subject to the same import tariffs regime.

Figure 2.13 Global trade flows along the solar PV supply chain, 2021

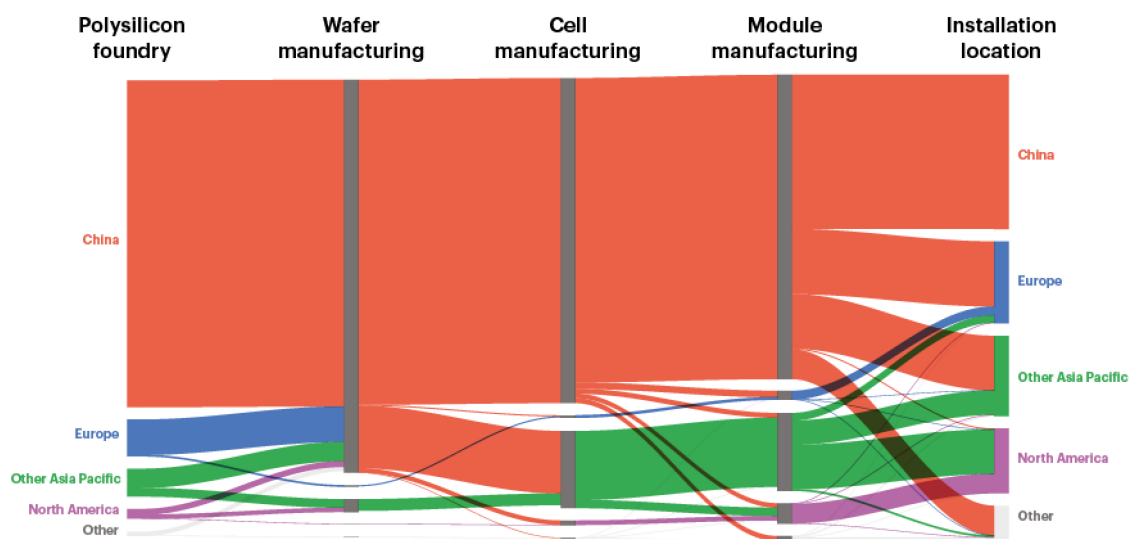

IEA. CC BY 4.0.

Note: Normalised values based on gigawatts equivalent of capacity.

Source: IEA analysis based on IEA (2022b).

China accounts for the vast majority of manufacturing and exports globally except to North America. The Asia Pacific region, especially Southeast Asia, is also a key exporter.

Even though wind turbine components are heavy and bulky, the international trade of towers, blades and nacelles is quite common. For example, in the United States, one of the largest wind markets, the domestic content of blades and hubs is lower than 25% (US DOE, 2022a). Therefore, regions with competitive

labour markets and good availability of resources – such as steel, which accounts on average for almost 30% of the costs of an onshore wind turbine – may have a competitive advantage.

China is also a major player in wind turbine component production, accounting for 60% of global manufacturing capacity and half of total exports, most of which go to other Asian countries and Europe (Figure 2.14). North America was the biggest net importer in 2021, with one-quarter of imports (calculated on a regional basis) coming from a diverse set of countries. Due to the high costs of shipping turbine components, such as blades, nacelles, platforms, towers and vessels, only less than a fifth of their global output is traded inter-regionally. In addition, regulatory and trade policies are increasingly pushing manufacturers to build their supply chains in the countries in which they are installed. The most common policies include local manufacturing requirements, subsidies or incentives for building local manufacturing capacity, and import tariffs. More than 20 countries, including 7 advanced economies, have implemented local content requirements for wind energy, as well as solar PV (PIIE, 2021). For instance, in Brazil, developers are ineligible for low-cost financing from the country’s development bank unless they use local equipment (Bazilian, Cuming & Kenyon, 2020). In the United States, the IRA provides tax credits for domestic production of offshore wind components, while anti-dumping duties are imposed on several countries, including Canada, Indonesia, Spain and Viet Nam. The European Union imposes a levy on some imports of steel towers for wind turbines from China (EU, 2021).

Figure 2.14 Global trade flows of wind energy components in USD, 2021

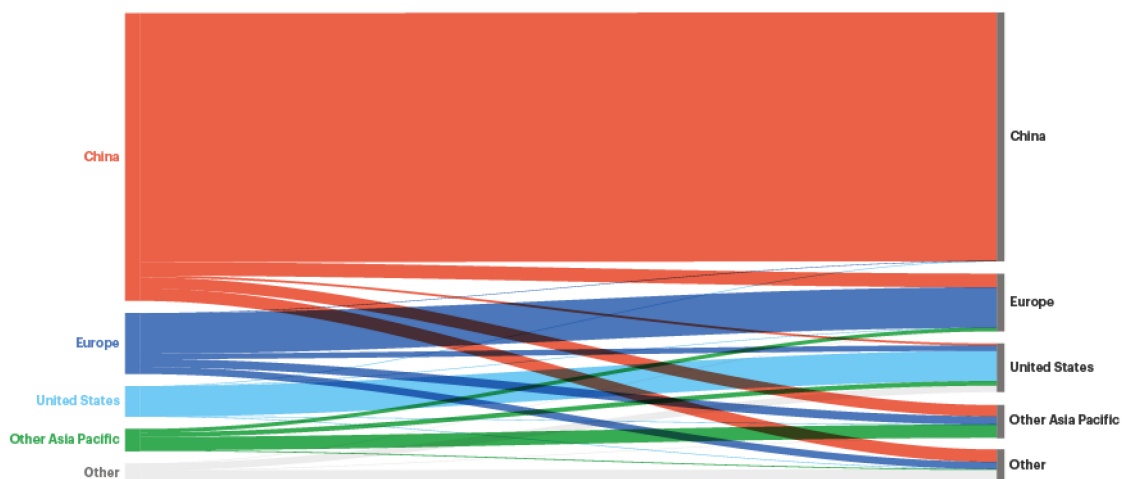

IEA. CC BY 4.0.

Note: Data for wind-powered generating sets were used as a basis to estimate trade for wind nacelles and blades.

Sources: IEA analysis based on Eurostat (for generating sets, wind-powered, DS-645593) Eurostat (2022); US Department of Energy (for wind-powered generating sets, towers, generators, blades, hubs and nacelles) US DOE (2022a); the US International Trade Commission (for wind-powered generating sets and parts, blades and hubs) USITC (2021); USITC (2022); and analysis based on IEA investments data IEA (2022e).

China accounts for more than 60% of global wind turbine manufacturing and half of exports, and Europe is the second-largest exporter of wind turbines.

Heat pumps are not widely traded

Establishing a domestic manufacturing industry does not always involve exports. For example, heat pumps within the boundaries of this analysis are traded much less than solar PV modules, though some individual components are widely traded. The share of inter-regional trade in global manufacturing is less than 10% for heat pumps, compared with nearly 60% for solar PV. Heat pumps are relatively bulky, making them costly to transport. Heat pumps are also adapted to regional conditions and often not suitable for a market other than the one they were produced for. For example, the Ecocute water heaters have been developed specifically for the Japanese market (HPTCJ, 2022). Heat pumps also need to meet legal requirements in local markets concerning recyclability, efficiency, voltage, safety and refrigerants. In 2021, Europe and North America were net importers of mainly heating heat pumps¹⁶, while China, Japan and Korea were net exporters (Figure 2.15). The market of air-to-air reversible heat pumps, which in some cases have a heating function just as important as the cooling function, is more dynamic and led by Asian countries which are exporting worldwide.

Figure 2.15 Global inter-regional trade flows of heat pumps, 2021

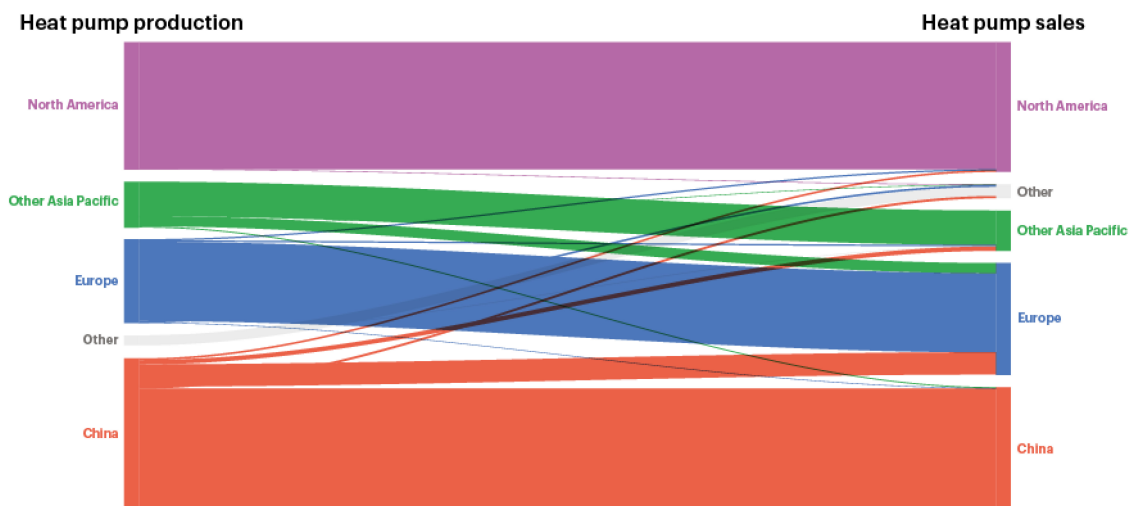

IEA. CC BY 4.0.

Notes: HP = heat pumps. Normalised values based on gigawatts of thermal output. Heat pump sales and production are based on market data and IEA modelling estimates. Trade flows are based on the UN Comtrade database (harmonised system product code: 841861). Code 841861 refers to “heat pumps other than air conditioning machines of heading no. 8415” (i.e. it exclusively refers to heating equipment), and it is therefore used as a proxy for “mainly heating heat pumps”. Several additional UN Comtrade codes are associated with heat pump technology: code 8415 for air conditioners, code 841581 for reversible air-to-air heat pumps, and code 841869 for “refrigerating or freezing equipment, heat pumps other than compression type units whose condensers are heat exchangers”. However, those groupings include both cooling and heating-oriented equipment.

Sources: IEA analysis based on UN (2022a) and company announcements.

The heat pump market is regionally compartmentalised. China and North America import very few units, while Chinese imports account for around 20% of European sales.

¹⁶ Associated in this instance to HS product code: 841861, which refer to the narrower definition of heat pumps “Heat pumps; other than air conditioning machines of heading no. 8415”.

Most of the largest heat pump manufacturers are headquartered in the **Asia Pacific** region (including China), manufacturing about 75% of the heat pumps sold globally in 2021 (Figure 2.16). Companies with headquarters in Japan accounted for almost 40% of the global market, and those in China about 30%. The five largest global manufacturers have their headquarters in Asia Pacific. However, about half of the production capacity of manufacturers headquartered in Asia Pacific is located outside of the region.

Manufacturing of heat pumps by companies with headquarters in **China** is largely for the domestic market. China hosts about 40% of global heat pump manufacturing capacity, of which about two-third is from local companies. Most of the manufacturing capacity in the country is located in just four provinces: Shandong, Anhui, Zhejiang and Guangdong. Driven by growing domestic and external demand, manufacturing capacity in China continues to expand, benefiting from complementarities with the air-conditioner industry, with several new Chinese players emerging each year (AskCI, 2022). To encourage the uptake of more efficient models and facilitate exports, China is developing more stringent energy efficiency standards and testing practices to align them with international standards (ECECP, 2022; Cheng, 2022). China's heat pump exports almost doubled in 2021 compared with 2020, driven mainly by demand in Europe, which has been the main destination of air-source heat pump equipment for several years.

In **Europe**, intra-regional trade is common, but the sudden surge in demand for heat pumps in 2021, combined with an open trade policy, led to a sharp increase in imports from outside the continent, almost exclusively from Asian countries. With about 170 heat pump factories, Europe accounts for about 15% of global manufacturing capacity (Lyons et al., 2022). Companies with headquarters in Europe account for about 10% of global heat pump capacity. Europe is a leader in manufacturing hydronic systems and many companies have markets also outside Europe, while about half of manufacturing capacity within the region is owned by companies with headquarters elsewhere. The current energy crisis and policy support for heat pumps is attracting investment. Announced expansion plans in the region suggest that manufacturing capacity in Europe will keep pace with the expected medium-term growth in demand (see Chapter 4).

As in other regions, the market for heat pumps in **North America** is growing rapidly. In 2021, it accounted for about 30% of global heat pump manufacturing capacity, mostly in the United States, and enough to cover domestic demand. Imports to the United States were limited, and foreign companies accounted for about 70% of domestic production.

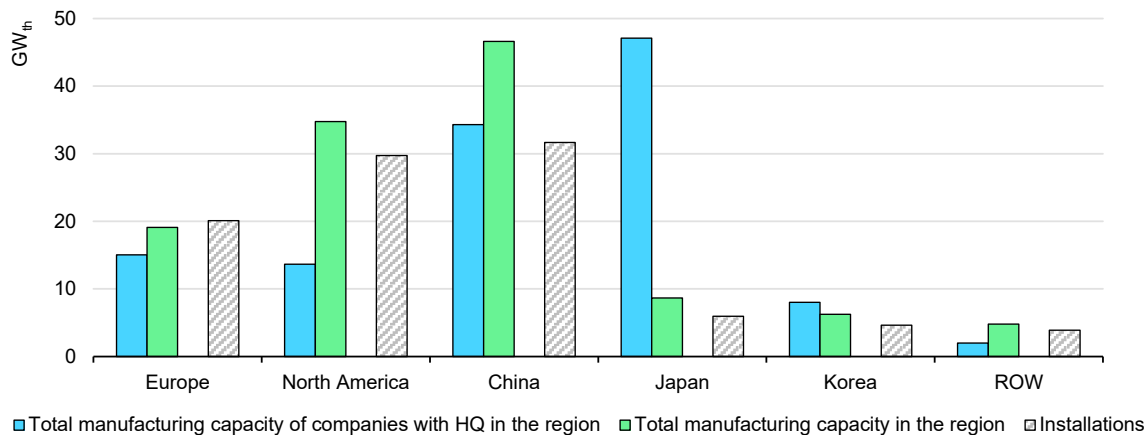
Figure 2.16 Heat pump manufacturing capacity by company headquarters and plant location, and installations by region/country, 2021

IEA. CC BY 4.0.

Notes: ROW = rest of the world; HQ = headquarters. Blue columns refer to the global manufacturing capacity of firms headquartered in the country/region, not only their manufacturing capacity in the country/region. Green columns refer to the total manufacturing capacity in the country/region, regardless of where manufacturers are headquartered.

Sources: IEA analysis based on company strategy announcements; EHPA (2022); AHRI (2022); Chinabaogao (2022); JRAIA (2022).

More than half of the heat pumps sold in Europe and North America are manufactured by companies headquartered abroad.

Resilience of supply chains

Recent commodity supply disruptions and price rises

Global commodity prices have been surging across the board in the last few years in the wake of supply disruptions resulting from the Covid-19 pandemic, rising demand as the global economy started to recover, and Russia's invasion of Ukraine in February 2022. Electricity shortages in China and the geopolitical repercussions of the war in Ukraine, including economic sanctions on Russia and lower gas exports to Europe, have further disrupted supply chains and driven up the prices of a wide range of commodities. Europe has been hit particularly hard by higher gas prices, which have driven up electricity prices. Clean energy technology supply chains have been affected by sanctions on Russia, such as those of EV batteries, since Russia is a leading producer of Class 1 nickel.

Disruptions to supply chains in the last few years alongside rising material and mineral costs have already started to drive up the cost of key clean energy technologies, which could delay efforts to accelerate the transition. For example, the average cost of solar PV modules worldwide rebounded by 25% between the first half of 2020 and that of 2022, having declined for many years, primarily due to price increases of material inputs (IEA, 2022e). In particular, the price of PV-grade polysilicon doubled over that period, before dropping again at the end of 2022 (Bloomberg, 2023). The cost of wind turbines outside China has also been rising after years falling, due to supply problems, rising demand, and more

expensive inputs: copper and steel prices doubled between the first half of 2020 and that of 2022. While Chinese wind turbine prices continued to fall by around 40% over this period, they rose elsewhere by up to 20% (BNN Bloomberg, 2022). Spiking prices of cobalt, lithium and nickel in the beginning of 2022 led to higher battery pack prices, which rose by 7% in real terms on average in 2022 relative to 2021, with significant regional disparities: up 24% in the United States and 33% in Europe while remaining cheapest in China (BNEF, 2022b). Even low-cost cathode chemistry battery packs such as lithium iron phosphate increased – by 27% – due to their exposure to lithium carbonate prices. Leading EV carmakers, including Tesla and Ford, have raised prices and lowered profit forecasts as a result of higher battery prices and the rising cost of other raw materials and components (Reuters, 2022; Lambert, 2022).

Recent high energy prices have also contributed to higher production costs for energy-intensive bulk materials such as cement, steel, ammonia and other metals. As the base inputs to many other supply chains, the effects have been far-reaching. The EU steel industry has been particularly affected, with production from August to October about 15% lower in 2022 than in 2021 due to record gas and electricity prices (Worldsteel, 2022b). Chinese steel production dropped by over 6% year-on-year in the first half of 2022, due to coal and electricity shortages and reduced construction demand, partly caused by the impact of measures to curb the spread of Covid-19 (China, MIIT, 2022). Electricity shortages were exacerbated by a reduced hydropower supply due to drought and surging demand for cooling due to a heatwave, resulting in lower industrial output. For example, a large proportion of industrial manufacturing in 19 cities in Sichuan was shut down for six days in August 2022 (Sohu, 2022).

Figure 2.17 International prices of selected critical and bulk materials and energy

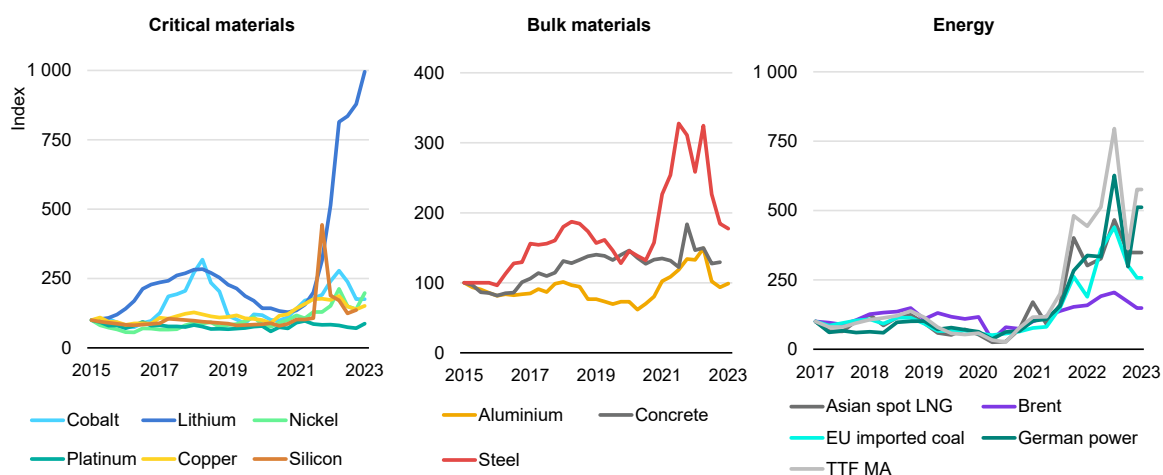

IEA. CC BY 4.0.

Notes: LNG = liquefied natural gas; TTF MA = Title Transfer Facility. Prices are quarterly values indexed to the beginning of 2015 for critical and bulk materials, and to the beginning of 2017 for energy prices. German power values are monthly averages.

Sources: IEA analysis based on S&P Global (2022b) and Bloomberg (2022a).

Global commodity prices have surged due to increasing demand and supply disruptions caused by the Covid-19 pandemic, China’s energy crisis and Russia’s invasion of Ukraine.

The Covid-19 pandemic has also had an adverse impact on industrial supply chains, contributing to the jump in commodity prices in 2021 (Figure 2.17). For example, during the first wave in India in early 2020, industrial output dropped by over 60% between February and April as the country experienced a strict lockdown with some sectors ceasing activity entirely; it took about five months for output to recover fully. In the second wave in early 2021, no mandatory lockdown and better supply chain preparedness limited the speed and severity of the fall in Indian industrial output to about 20% between March and May, with a similar recovery time. The steel and cement industries were hit particularly hard by the initial restrictions on economic activity, with production falling by approximately 75% for steel and 85% for cement in the first wave, while declines were limited to 10-20% in the second wave (Government of India, 2022).

Impact of higher costs on clean energy technologies

Increases in energy and other commodity prices can affect specific clean energy technologies in different ways and to varying degrees, mainly according to the extent to which they depend on different types of commodities, including energy (Figure 2.18). Industry prices of energy, especially gas and electricity, vary greatly across regions, and so do price trends in case of disruption. In contrast, prices of non-energy commodities tend to be more homogeneous globally, with some exceptions.

Some technologies are heavily dependent on bulk and critical materials, with manufacturing accounting for a smaller share of their total cost. For example, bulk and critical materials make up a large share of the total cost of supplying EV batteries and manufacturing electric cars, fuel cell trucks, heat pumps, solar PV panels and wind turbines (Figure 2.19).

In the case of cars, the cost of critical materials for EVs – and that of bulk materials for both EVs and conventional vehicles – is much higher than the energy costs associated with manufacturing and assembly. While the cost of parts and vehicle manufacturing and assembly can also be exposed to energy price disruptions such as that of natural gas, they are much more exposed to disruptions in the costs of bulk and critical materials. Depending on the country of production, the aggregate cost of critical materials to produce an EV may be three to six times higher than the cost of the energy needed for manufacturing – and it is seven times higher than the cost of the critical materials needed for an ICE vehicle. Overall, the energy costs in manufacturing an EV can be 10% higher than those for an ICE vehicle.

Higher energy costs have driven up the cost of producing critical minerals, the extraction and processing of which are particularly energy-intensive. In most cases, mining and refining such minerals are more energy-intensive per tonne than for aluminium and steel, although the volumes used in clean energy technologies are much smaller. For certain critical materials, a large share of the energy currently used for these steps, much of it for refining, is in the form of natural gas: 35% for cobalt and nickel, and 50% for manganese. Higher gas prices have also driven up the price of electricity, which makes up much of the rest of the energy used in mining and processing for many of them. The extent to which gas and electricity prices have risen varies enormously across regions, resulting in big shifts in the relative competitiveness of manufacturers, with European mineral refiners being disadvantaged the most.

Figure 2.18 Energy intensity of extracting and producing selected critical and bulk materials, and of manufacturing selected energy technologies, 2021

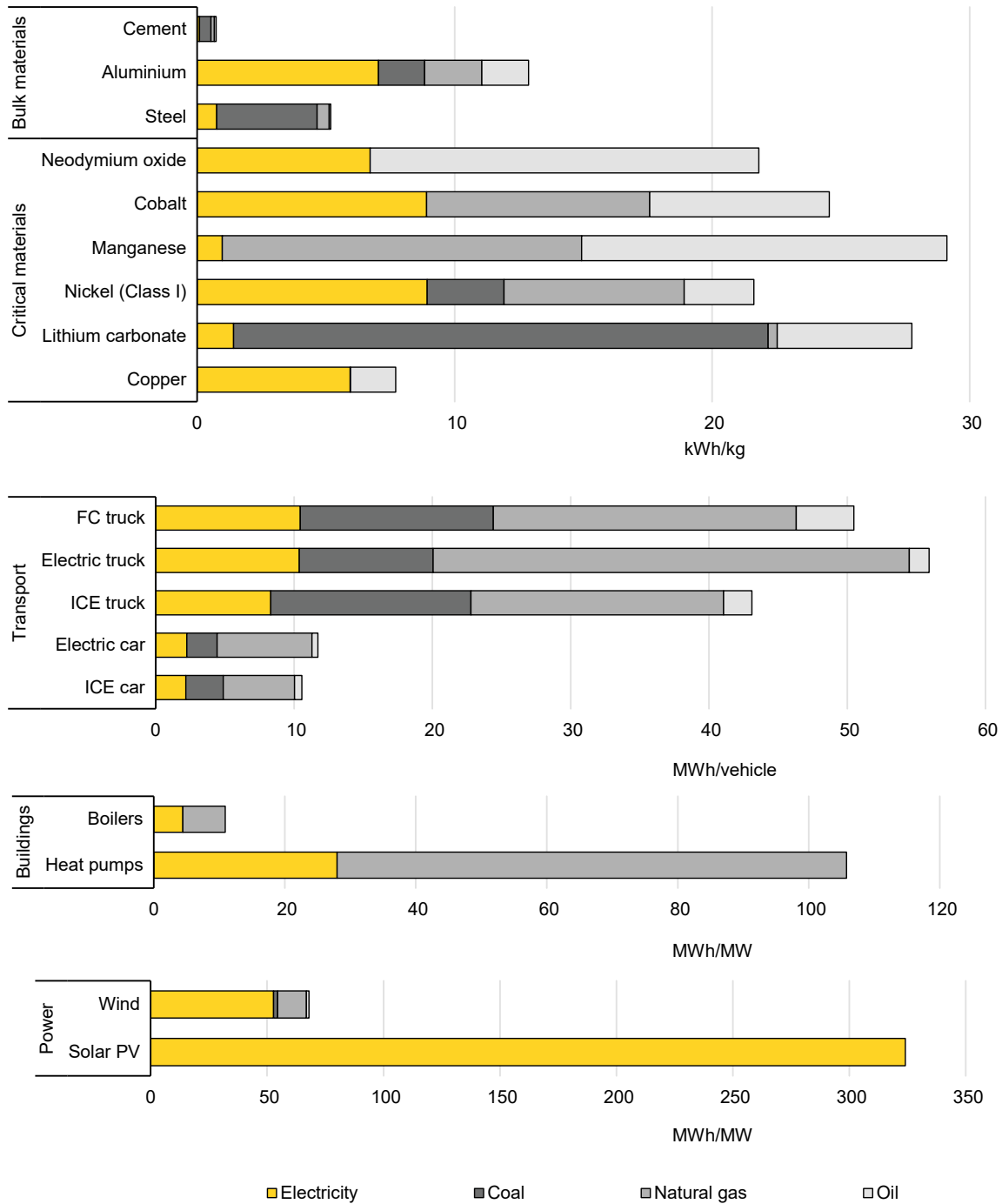

IEA. CC BY 4.0.

Notes: FC = fuel cell. Critical and bulk materials include energy intensity from mining and processing raw ores. Primary production only. The estimate for wind power assumes a permanent magnet of 650 kg with an energy intensity of 119.0 megajoules/kg.

Sources: IEA analysis based on Hongyue Jin et al. (2018); Siemens Gamesa (2021); Goldwind (2021); Vestas (2021).

The extraction and processing of critical materials and the manufacturing of clean energy technologies are highly energy-intensive, relying mainly on fossil fuels.

Figure 2.19 Average manufacturing cost breakdown of selected energy technologies and components by commodity, 2019-2021

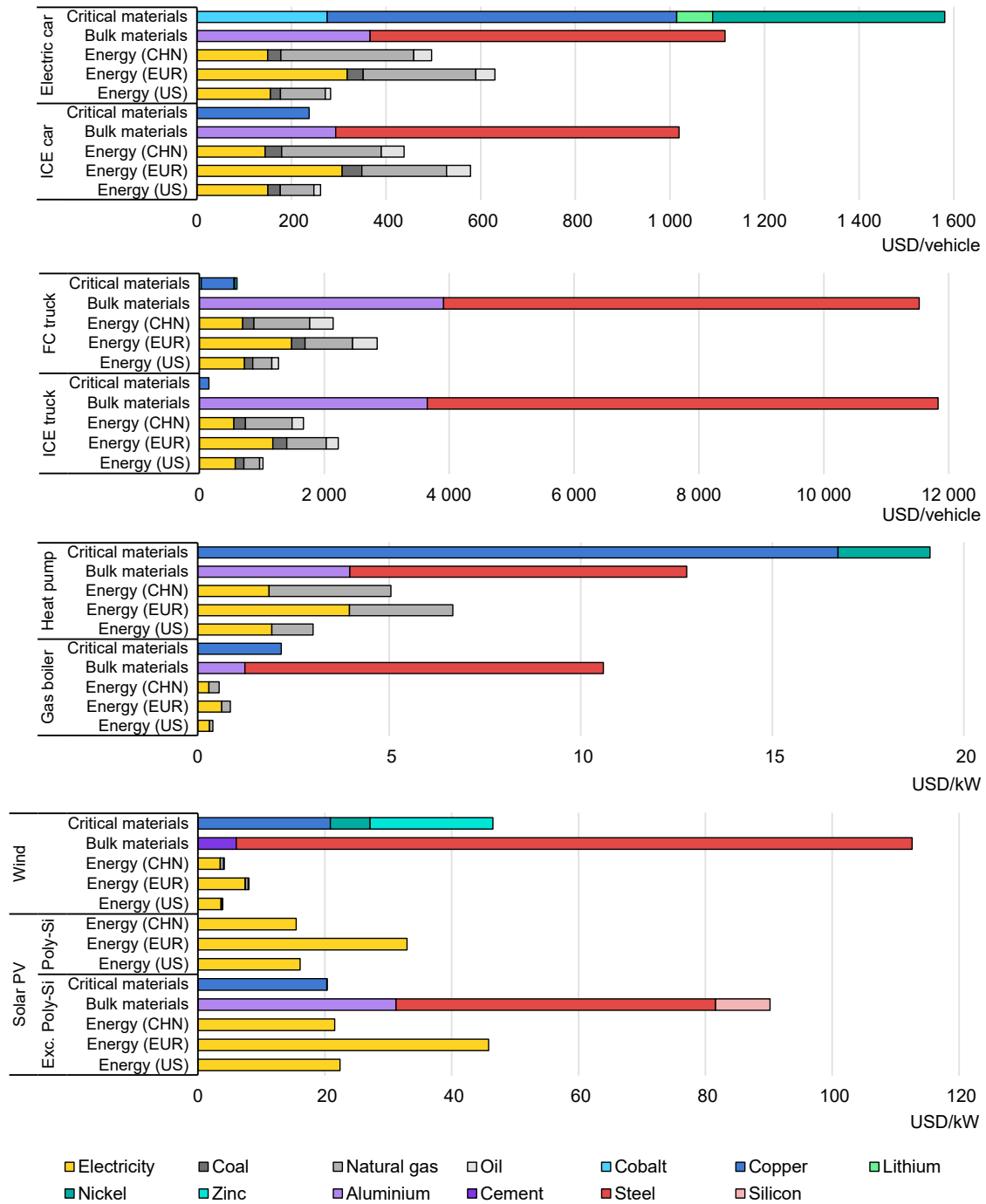

IEA. CC BY 4.0.

Notes: CHN = China; EUR = Europe (France, Germany, Italy, the Netherlands and Poland). Average prices over 2019-2021 are used, with the exception of electricity in China (average over the first half of 2022). Energy costs refer to the cost of energy used to manufacture vehicle parts and assemble the vehicle, including material transformation steps and EV battery assembly, but excluding mining and production of materials. For oil, prices of liquid petroleum gas are used, or that of light fuel oil, gasoline or diesel, depending on data availability. Global average prices are used for critical and bulk materials.

Sources: IEA analysis based on S&P Global (2022b); USGS (2022); Saoud, Harajli & Manneh (2021).

Materials generally account for a greater share of total manufacturing costs than energy. It can be more expensive to produce clean energy technologies than incumbent ones.

Higher energy costs have also depressed the production of ammonia, especially in Europe, where the price of natural gas – the leading feedstock – has increased most (Box 2.3). The cost of producing ammonia depends heavily on the price of energy. Around 70% of European ammonia production capacity had been taken offline in August 2022, with an estimated 40% remaining offline in October despite reductions in gas prices (IFA, 2022). Ammonia production had already been disrupted in 2021 by various gas supply disruptions, including in the United States, where the availability of natural gas was hit by cold weather and the effects of Hurricane Ida (American Farm Bureau Federation, 2022). As a result, US ammonia prices increased sixfold between the first quarter of 2020 and that of 2022 (Bloomberg, 2022b). Higher ammonia prices worldwide have pushed up the cost of ammonia-based fertilisers and, therefore, contributed to food price increases: the Food and Agriculture Organization index of food prices jumped by a third over the year to March 2022 to an all-time high (UN FAO, 2022). Global demand for ammonia is relatively price inelastic as 70% of ammonia is used for making fertiliser. As a result, reduced supply has a significant impact on food prices with catastrophic consequences for food supply, especially in emerging economies (IEA, 2022f).

The effects of higher energy prices on industries and products further down the supply chain are often less obvious, but no less important. For example, AdBlue – a fuel additive used to reduce emissions from diesel cars and trucks – is a crucial component in the trucking industry. It is derived from urea, which is also a key ingredient in fertiliser production, produced using natural gas. High natural gas prices in China in 2021 led to restrictions on the export of urea to support the domestic fertiliser industry. This led to a critical shortage of AdBlue in Korea and Australia in December 2021, with prices in Australia quadrupling. More recently, reduced urea production in Germany has led to a sharp fall in inventories of AdBlue and much higher prices across Europe.

Box 2.3 Resilience and vulnerabilities in the ammonia supply chain

Ammonia offers a good example of how supply chains can be resilient or vulnerable to disruption. Global ammonia production held up well compared with other industrial sectors at the start of the Covid-19 pandemic and rebounded in 2021. Producing alternatives to ammonia-based products is particularly difficult, and the near-term potential for demand-side substitution is limited. Demand for ammonia-based fertiliser is relatively price-inelastic, i.e. demand responds little to changes in price, so that modest reductions in supply result in much bigger increases in price. Despite this, production fell back in 2022 with higher natural gas prices, which have driven up costs significantly and made production in some parts of the world, notably Europe, uneconomic.

Ammonia production is widely distributed around the world, with trade representing around 10% of world output (30% for urea – the main derivative of ammonia) (IEA, 2021b). There is an extensive network of port, pipeline and storage facilities, generally specifically dedicated to ammonia or derivatives. Demand is highly seasonal, so storage capacity is large. For example, capacity in the United States amounts to about half of its annual production, spread across more than 10 000 facilities (Royal Society, 2020). Trade provides a degree of flexibility in ammonia supply, helping to limit fluctuations in ammonia prices in the event of short-term changes in production or demand, though changes in shipping patterns can still take months or even years. Building new infrastructure can take several years, which is longer than for other materials that do not require specialised facilities and can use existing flexible infrastructure that can be quickly refitted. The development of new markets for ammonia, such as use as a marine transport fuel, would add to the need for additional storage and production capacity.

Figure 2.20 Average ammonia production costs by technology and component in selected regions/countries, 2022

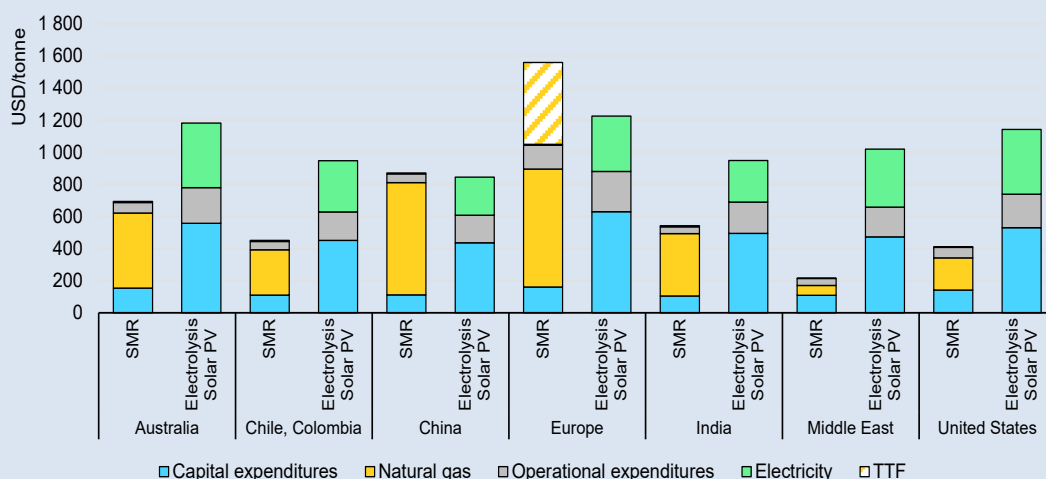

IEA. CC BY 4.0.

Notes: TTF = Title Transfer Facility. For natural gas, average industrial prices from January to October 2022 have been used; the dashed area for Europe represents the additional cost of using the TTF natural gas price. Capital expenditures include the costs of the installed plant, assuming a cost of capital of 5%. Natural gas costs are in the range of USD 7/MWh to USD 80/MWh (USD 140/MWh in the case of TTF), electricity costs are in the range USD 20/MWh to USD 30/MWh. Costs related to carbon pricing, where applicable, are included in the operational expenditures.

The heavy dependence of ammonia production on fossil energy is a key supply chain vulnerability for fertilisers and other ammonia-based products (Figure 2.20). About 70% of all the ammonia produced worldwide in 2021 was based on natural gas, with coal supplying the bulk of the rest. Being both feedstock and raw material, gas and coal make up a greater proportion of the total cost of producing ammonia than for many other commodities such as steel. Gas and coal markets

can be very volatile, making ammonia production highly vulnerable to geopolitical and other factors that affect supply in the near term. As a highly tradeable commodity, ammonia producers in regions where gas prices are highest may be forced to idle capacity at times when production is uneconomic.

Diversifying sources of gas as a way of lowering prices – the approach being adopted by Europe in the face of a shortfall in Russian gas – can take years. In the longer term, switching to renewable hydrogen from electrolysis would make ammonia supply chains more resilient, but that production path generally remains more expensive for now despite higher gas prices.

Impact of mineral price rises on mining company profits

The recent surge in commodity prices has led to a sharp increase in the profits of firms involved in the extraction of raw materials, including fossil energy and minerals, and the production of bulk materials such as cement, steel and aluminium (Figure 2.21). Companies involved in extracting critical minerals, notably lithium, nickel and copper have enjoyed the biggest gains in profits, with the increase in the prices of those metals more than offsetting the effect of higher energy costs. This is boosting the attractiveness of new investment in mining projects, though the lead times are generally very long. Firms in the middle of the supply chain that produce bulk materials have seen more modest improvements in their profitability as energy accounts for a large share of production costs. Metal refiners and smelters have generally profited less from higher commodity prices as they have been harder hit by higher energy costs, especially in Europe, where some have been forced to halt operations.

By contrast, the profit margins of several manufacturing industries have been squeezed by the increase in the costs of bulk materials and energy. In the case of wind equipment manufacturing, steel and concrete account for a large share of costs, which cannot always be passed quickly on to buyers with higher prices, thereby reducing their margins. In the long term, however, higher fossil energy and electricity prices should boost the competitiveness of wind power and other renewable generating technologies, increasing demand for turbines, despite higher installation costs.

Figure 2.21 Return on assets of companies in selected upstream, bulk materials and manufacturing sectors

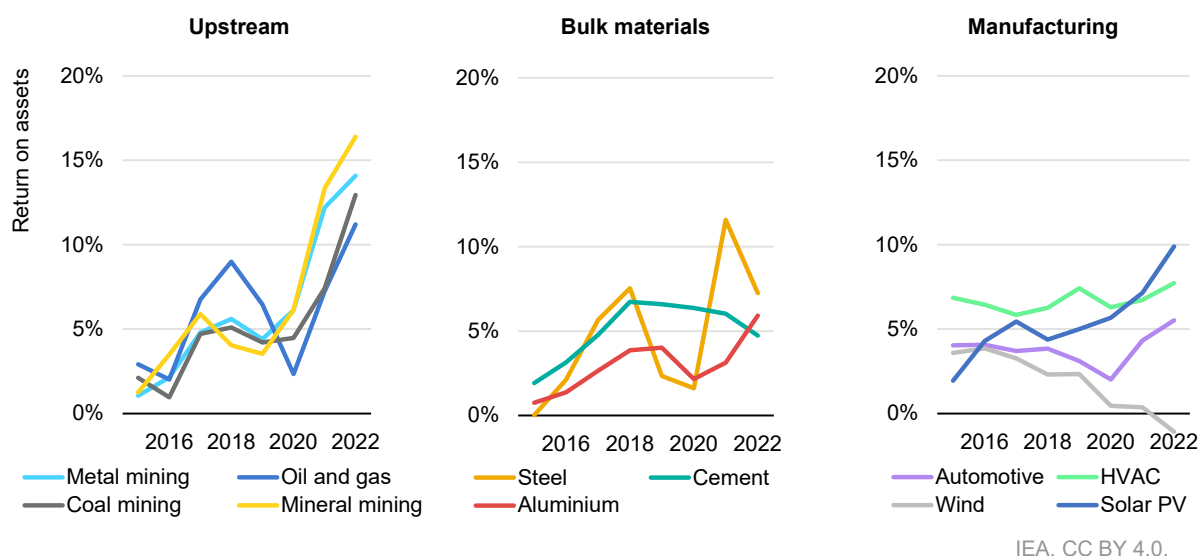

IEA. CC BY 4.0.

Notes: Mineral = critical minerals; HVAC = heating, ventilation and air conditioning; Wind = wind power equipment.
 Source: IEA analysis based on Bloomberg data.

Higher commodity prices have boosted the profits of firms involved in the extraction of fossil energy and minerals, and – to a lesser extent – producers of bulk materials.

Box 2.4 Stockpiles of critical minerals and energy security

Maintaining adequate stockpiles of vital material and components is essential for companies to handle any temporary disruptions or dislocations in supply. Strategic reserves to handle more severe disruptions are the responsibility of governments. The practicalities and costs involved in maintaining commercial inventories vary greatly, according to the type of material, the quantities consumed and the seasonality of demand for the final product. For example, solids are generally easiest to store, followed by liquids and then gases. Commodities for which demand is seasonal, such as ammonia used for making fertiliser, generally require larger inventories.

Figure 2.22 Global inventories as a share of annual consumption for selected bulk materials, minerals and fuels

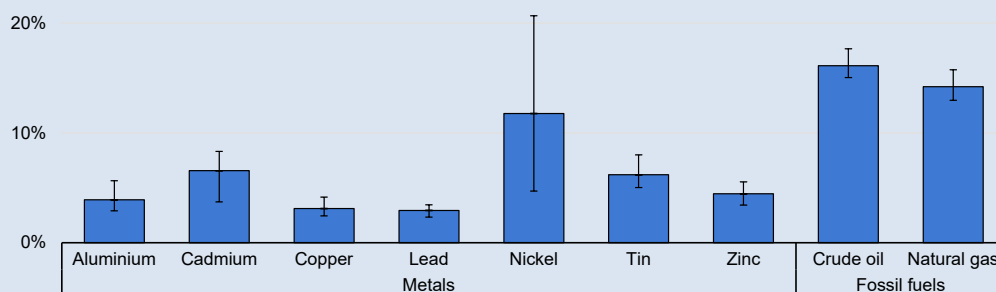

IEA. CC BY 4.0.

Note: Metals represent average inventory 2016-2021 and its annual variability over the time period.

Source: IEA data; WBMS (2022).

Current commercial stockpiles are generally much larger for bulk commodities, oil and gas than for critical minerals, reflecting mainly the greater seasonality of demand and, in the case of oil, the heightened risks of disruptions and the large costs associated with them (Figure 2.22). In addition, a disruption to mineral supplies would be less immediate than a disruption to oil supplies, as it would influence production of new equipment and products only rather than the use of existing equipment. However, critical mineral supplies are currently more geographically concentrated than that of oil. Lack of data and storage at different stages of products make assessing total global inventories for bulk materials such as cement, steel and ammonia difficult, with only limited data points available. For example, Chinese steel inventories were estimated to be around 37 Mt (4% of national production) before the Covid-19 pandemic, and new estimates suggest they ballooned since to approximately 100 Mt due to weak demand (S&P Global, 2020). Companies need to balance the cost of maintaining inventories with the flexibility they provide as critical minerals become a more important part of the global energy system.

Digitalisation of supply chains

Digital technologies can speed up the energy transition

Digital technologies can improve efficiency, reduce costs and accelerate innovation across clean energy supply chains, but they need to be made resilient to a number of threats. There are many ways in which they could contribute to speeding up the clean energy transition (Table 2.2). They can help optimise the operations of electricity systems (Wind Europe, 2021; ETIP Wind, 2016; GE, 2015). Machine

learning (ML) can accelerate the development and discovery of novel battery materials to reduce the use of critical materials in EV batteries, as well as improve supply and demand forecasting and real-time analysis of grid conditions (DeepMind, 2019). Satellite imaging and machine learning can help identify locations of higher solar and wind output. Blockchain technology can enhance transparency and tracking of critical materials and enhance the environmental, social and corporate governance of minerals extraction. Product passports can facilitate recycling by providing information on material composition.

The resilience of digital hardware and components is becoming increasingly important as energy and other systems become more reliant on digital technologies. For example, semiconductor chips are essential for nearly every electronic device, including EVs, solar panels and electricity grids (Table 2.3). The average EV contains 2 000 to 3 000 chips – two to three times more than in a conventional car (Yoon, 2021).

Table 2.2 Examples of digital technology use across clean energy supply chains

Clean energy supply chains	Materials extraction and processing	Manufacturing and installation	Operation	End of life and recycling
EVs Solar PV Wind Electrolysers CCUS	Smart and connected mining to improve safety, boost throughput and reduce emissions. Blockchain to enhance transparency and tracking of critical materials and incentivise high ESG performance. ML to accelerate development of novel battery materials and screen alternative processes for hydrogen production and potential catalysts for CCUS.	ML and digital twins to optimise EV battery design and performance. 3D printing of solar PV and fuel cells to reduce material use, boost performance and improve durability.	Digitally enabled shared and automated mobility to reduce mineral demand. ML-optimised EV fast charging protocols to reduce battery degradation. Predictive maintenance through IoT, ML and drones to increase efficiency and extend lifetimes of solar PV, wind and grids.	Product passports to facilitate recycling. ML and robotics to improve waste recovery. Digital platforms to host secondary materials markets. Digitally connected dismantling and processing plants to aggregate waste volumes.

Note: IoT = Internet of Things.

Table 2.3 Use of semiconductors in clean energy technologies

Semiconductor materials	Applications in clean energy technologies
Photovoltaic semiconductors	Solar cells in conventional, thin film and perovskite PVs
Wide bandgap semiconductors (SiC, GaN)	Power electronics in solar PV, other renewables and grids, EVs, and electrified industry
Conventional semiconductors	Electronics and communication in solar PV, other renewables, grids, EVs, efficient computing, and electrified and efficient industry

Note: SiC = silicon carbide; GaN = gallium nitride.

Source: Adapted from US DOE (2022b).

Box 2.5 The chip shortage is holding back the deployment of EVs

The ongoing global chip shortage has had a severe impact on several clean energy technologies, notably EV manufacturing. The shortage took hold in 2020, driven by surging demand for computers and other consumer electronics during the early days of the Covid-19 pandemic and shortages caused by the temporary closure of factories and supply chain disruptions during lockdowns. The supply shortage has been exacerbated by fires in semiconductors plants in Japan and Germany, power outages affecting factories in Texas, and severe droughts in Taiwan.

Global supply, nonetheless, rebounded in 2021 to 1.15 trillion units, worth a record USD 550 billion in 2021 – an increase of 26% (SIA, 2022a). Computing and communications each accounted for around 30% of the market, while end uses for energy – automotive and industrial – each accounted for 12% (SIA, 2022b). With strong growth in EVs and automated driving, the automotive industry could represent nearly 15% of semiconductor demand by 2030, up from 8% today (McKinsey, 2022). McKinsey projects that the global semiconductor market could exceed USD 1 trillion by 2030, with automotive and industrial electronics demand growing on average by 11% per year – twice as fast as computing, communications and consumer electronics.

The United States accounted for nearly half of the global market by revenue in 2021 but only 12% of manufacturing capacity, down from 37% in 1990 (Figure 2.23) (SIA, 2022c). Asia accounted for nearly three-quarters of global manufacturing capacity, led by Taiwan (22%) and Korea (21%) (Varas et al., 2020). China is expected to add about 40% of the new capacity that is expected to come online by 2030, becoming the largest semiconductor producer. It is unclear how legislation introduced in the European Union and the United States to boost domestic semiconductor innovation and manufacturing will affect the market.

The energy cost crisis is also having an impact on chip manufacturing, which is highly energy- and water-intensive, with energy costs accounting for a significant

share of operating expenses. Taiwan Semiconductor Manufacturing Company (TSMC), the world’s largest contract chipmaker, consumed 18 TWh of electricity in 2021 – one-third higher than in 2019 (TSMC, 2021). Recent increases in electricity prices in Taiwan could cause knock-on effects on chip cost and supply (Bloomberg, 2022a).

Figure 2.23 Semiconductor manufacturing capacity and market share revenue, 2021

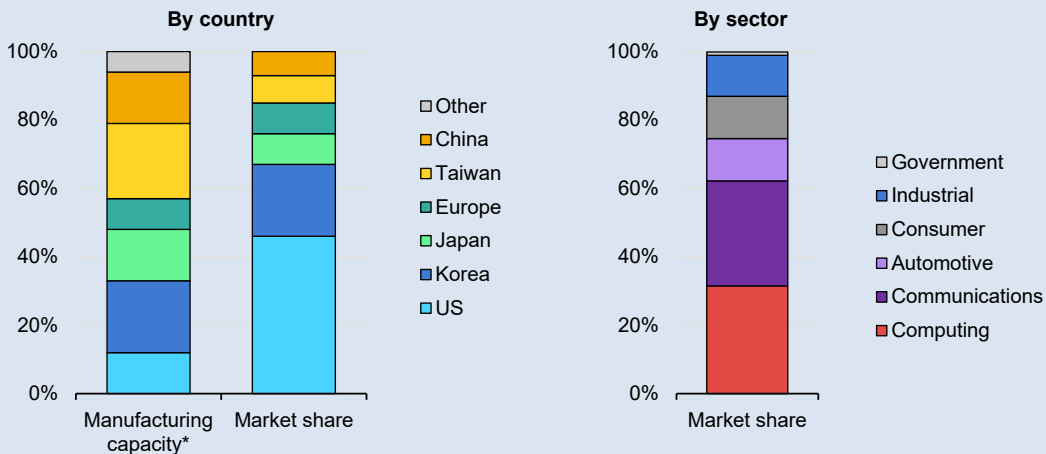

IEA. CC BY 4.0.

* Manufacturing capacity figures are for 2020.

Note: Market shares are based on 2021 revenues.

Sources: Varas et al. (2020); SIA (2022c).

Cybersecurity risks are growing

As the energy system becomes more digitalised, connected and automated, cybersecurity risks are increasing. Hackers are becoming increasingly sophisticated, with successful attacks triggering the loss of operating control over devices and processes, in turn causing physical damage or service disruption. There are many ways in which cyberattacks could affect energy systems, such as a virus infiltrating an industrial control system through USB flash drives, the manipulation of a large number of high-wattage connected devices or compromised equipment from supply chain vulnerabilities (IEA, 2021c).

The supply chains of power systems are particularly vulnerable to cyberattacks. For example, malicious code can be inserted into software at an early development phase, with back doors built into hardware to enable remote access after installation, thereby allowing attackers to steal data or disable systems. This highlights how the resilience of the system also depends on the level of cyber resilience of each stakeholder along the supply chain.

Supply chain sustainability

Reducing emissions from the mining, processing, manufacturing and transport of materials and final clean energy products is essential as their deployment increases. The upstream steps of clean energy technology supply chains today are generally more emissions-intensive than downstream ones, mainly because the required temperature of thermal processing is higher and because low-emission alternatives to fossil fuels, including electricity, are not yet widely available. The task of reducing supply chain emissions is made harder by the sheer rate of growth of supply expected in the coming years, as well as the prospect of a decline in the quality of critical mineral resources, which means more energy is needed to produce a tonne of those minerals.

Carbon intensity

Clean energy technologies are, by definition, capable of providing services without directly emitting a significant amount of CO₂, but their supply chains may do, depending on the type of energy used in the production processes and transportation. The earlier steps of clean energy technology supply chains today are generally more emissions-intensive than later ones, mainly because the temperature of thermal processing is higher and because practical low-emission alternatives to fossil fuels, including electricity, are not yet available. Material production is typically the most energy-intensive step and, consequently, generates the most CO₂ emissions. Globally, steel, aluminium, cement, paper and chemicals production together emit three times more than all other industries combined. In the case of EV batteries, mining and material production currently account for more than 50% of the total emissions associated with its production (Figure 2.24). Achieving net zero would require that these emissions are eliminated or balanced by emission removal in other sectors (see Chapter 1).

The mining, material production and manufacturing segments of clean energy technology supply chains tend to be more energy- and emissions-intensive than those of conventional fossil energy. However, those emissions are often balanced by much lower direct emissions from operation (Figure 2.25). While the manufacturing of an EV today emits on average around 50% more CO₂ than an equivalent ICE car, this difference is more than offset by the much higher emissions from the oil used in driving an ICE vehicle over its lifetime compared with those from generating the electricity used for driving the EV. Calculated on a well-to-wheels (or life-cycle) basis, an EV currently emits on average 50% less CO₂ than an ICE car worldwide. This advantage will continue to grow as electricity systems decarbonise.

The emissions savings from switching to clean energy technologies are considerably larger when the life-cycle emissions associated with the supply of

fossil fuels, including the construction of upstream, transportation and refining facilities and their operations, are taken into consideration (Scope 1-3).¹⁷ For example, drilling oil and gas wells and building refineries require large quantities of cement and steel, while operating those facilities calls for significant amounts of energy, usually in the form of natural gas, fuel gases obtained on-site and electricity (generated on-site or supplied from the grid). We estimate that those supply chain emissions amount to around 19 kg of CO₂ equivalent per GJ of oil, representing about 20% of its average life-cycle emissions, 16 kg per GJ of gas (20%) and 12 kg per GJ of coal (10%).

Figure 2.24 Supply chain step shares in total CO₂ emissions from the production of solar PV, wind turbines, EVs and heat pumps, 2021

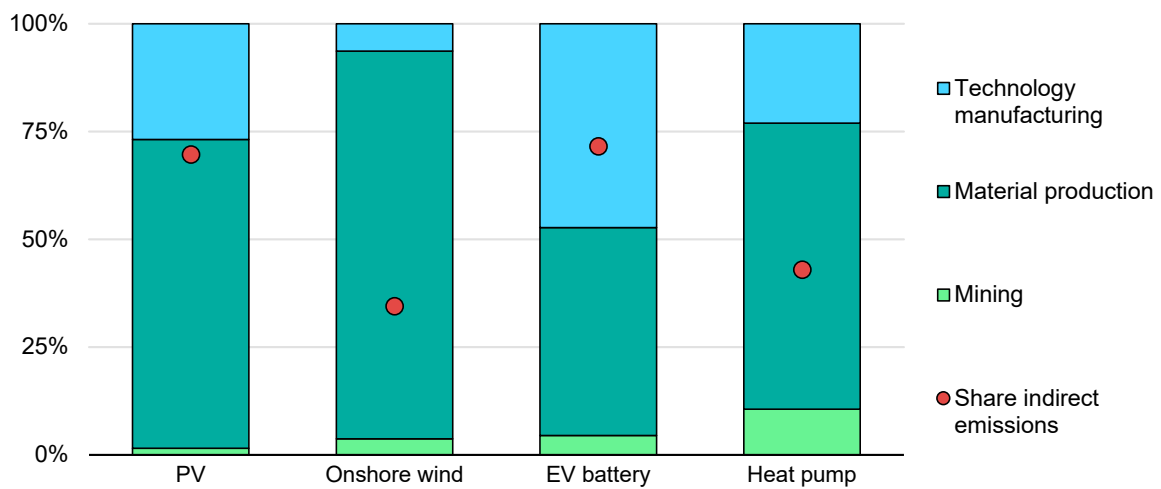

IEA. CC BY 4.0.

Notes: Includes direct and indirect emissions, with indirect emissions comprised of emissions for electricity generation and the production of chemicals used for mining and material production. Onshore wind and solar PV technology manufacturing does not include transport and installation. EV battery values refer to NMC 333 battery type. “Manufacturing” in EV batteries includes the emissions related to the production of components such as the cathode, as well as the assembly of the battery pack. An emission factor of 458 g CO₂/kWh is used to calculate electricity-related emissions.

Sources: IEA analysis based on Emilsson & Dahllöf (2019); Naumann, Schropp & Gaderer (2022); IEA (2022b); Argonne National Laboratory (2022); Siemens Gamesa (2021); Vestas (2021); Goldwind (2021).

Material production and technology manufacturing account for most of the CO₂ emissions of the selected clean technology supply chains.

¹⁷ Direct emissions, also called Scope 1 emissions, include emissions from fuel used during operations and process emissions. Indirect emissions are either associated with the generation of purchased electricity, steam and heat (Scope 2) or any other emissions related to the purchase of goods and services used in manufacturing (Scope 3).

Figure 2.25 Global average life-cycle greenhouse gas emissions intensity of selected energy technologies, 2021

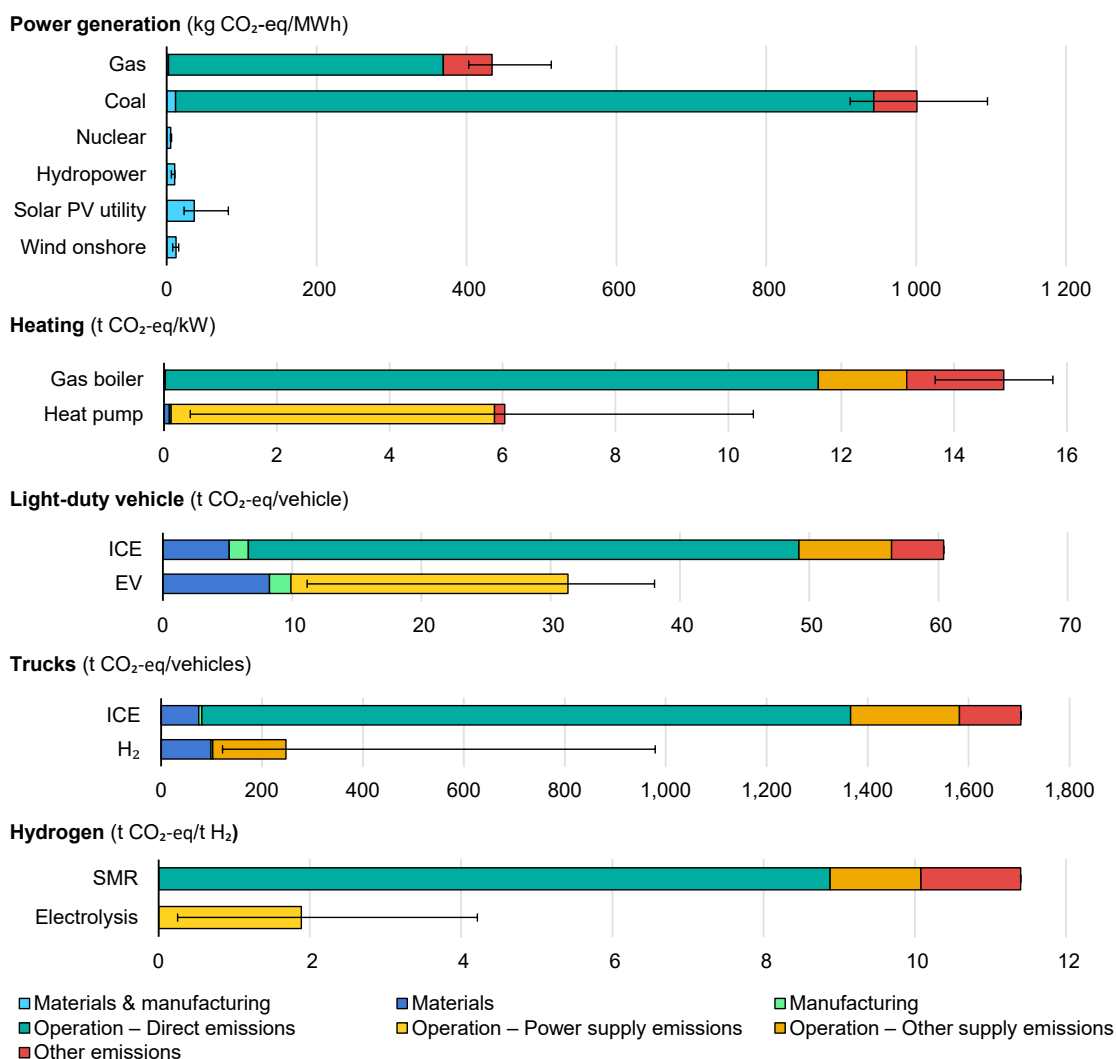

IEA. CC BY 4.0.

Notes: FC = fuel cell (powered by hydrogen); CO₂-eq = carbon dioxide equivalent. Stacked bars represent an average case while error bars represent low and high cases. Materials include resource extraction and processing. Manufacturing includes manufacturing of components and of the final product. Direct emissions are emissions from fossil fuel consumed during operation. Power supply emissions are those associated with the electricity consumed during operation. Other supply emissions include indirect emissions from fossil fuel and hydrogen production and refining. Other emissions include methane and refrigerant emissions. Power generation emissions are over the average lifetime of a power plant. For vehicles, disposal and recycling are not included. The average distance travelled assumed is 200 000 km for a car and 1.6 million km for a truck. Fuel cell trucks emissions' higher bound use SMR-based hydrogen while the average and lower bound use electrolysis-based hydrogen. It is assumed that EVs have a battery capacity of 55 kWh. For heat pumps, it is assumed that 50% of the refrigerant is vented to the atmosphere in the average case (20% for low and 80% for high). The coefficient of performance (which measures the efficiency of input to output of energy) is assumed to be 3/4/5 (low/medium/high) for heat pumps and 0.85/0.90/0.98 for gas boilers. For EVs and heat pumps, the emissions intensity of electricity is considered at 27/458/602 g CO₂/kWh (low/medium/high). For electrolysis, we assume power provided by low-emission energy sources: 5/37/82 g CO₂/kWh. For natural gas, 8 kg CO₂-eq/GJ of upstream emissions and 8 kg CO₂-eq/GJ for methane emissions are assumed. For oil products, those values are 12 and 7 kg CO₂-eq/GJ respectively. For more information on those technologies, please refer to other IEA publications such as the Global EV Outlook 2022 or the Global Hydrogen Review 2022.

Sources: IEA analysis based on Schlömer et al. (2014); Naumann, Schropp & Gaderer (2022); IEA (2021a); Argonne National Laboratory (2022); UNECE (2021).

The upstream steps of clean energy technology supply chains tend to be more energy- and emissions-intensive than those for fossil energy, but clean energy technologies emit far less in operation.

Heat pumps contain refrigerants with damaging climate potential if released in the atmosphere. In the case of the widely used R-134a refrigerant, emissions are equivalent to 1 430 kg CO₂ per kilogramme. Despite the ongoing shift towards lower GWP refrigerants, it is vital that leakages are avoided during the operation and decommissioning of heat pumps. Their use is being phased out under the Kigali Amendment to the Montreal Protocol, which was signed in 2016 and became effective in 2019 for 145 countries covering 80% of global greenhouse gas emissions (UN, 2022b; IEA, 2022g).

Carbon intensity today varies widely across the minerals and materials needed for clean energy supply chains (Figure 2.26). For some, intensity also varies across companies and regions according to site-specific factors, operational practices, the source of power, the fuels used and production pathways. In general, cobalt is much more energy- and carbon-intensive than steel, though much smaller amounts are usually needed to make specific products. For example, an EV typically requires around 7 kg of cobalt compared with 920 kg of steel and 220 kg of aluminium (Argonne National Laboratory, 2022). In addition, emerging sources of lithium and nickel are likely to be more energy-intensive than current ones, which could lead to higher emissions unless mining and processing companies switch to lower-emissions fuels (see Chapter 3). Indirect emissions associated with the supply of electricity or chemicals further increases the carbon footprint. For instance, Class 1 nickel emissions intensity jump from 3.4 tonnes of CO₂ per tonne to 8.9 tCO₂/t when indirect emissions are included.

Figure 2.26 Global average primary energy and CO₂ emissions intensity of mining and processing of selected critical and bulk materials, 2021

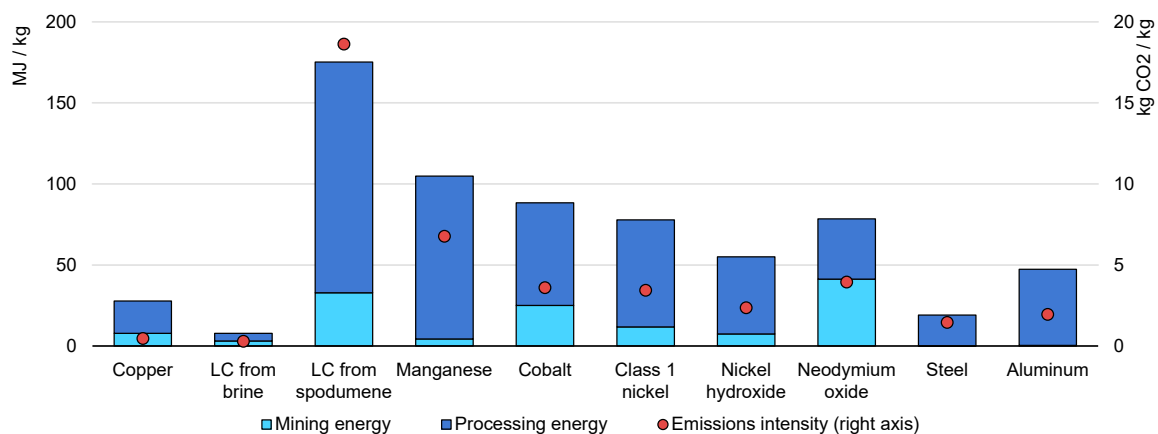

IEA. CC BY 4.0.

Notes: LC = lithium carbonate; MJ/Kg = megajoules of energy used to produce a kg of material; kg CO₂/kg = kilogrammes of CO₂ emitted in producing a kilogramme of material. Only direct emissions are considered. Neodymium oxide values are for production from bastnäsite ore.

Sources: IEA analysis based on Argonne National Laboratory (2022); IEA (2021a).

Carbon intensity varies widely across minerals and materials, according to operational practices, ore grade, power sources, fuels and production pathways.

Other environmental impacts of critical minerals

Exploiting mineral wealth can, in principle, create economic value, improve livelihoods and generate tax revenue. However, it can entail harmful environmental consequences other than emissions, including biodiversity loss and social disruption due to land-use change, water depletion and pollution, waste, and air pollution. While mining, by the very nature of the activity, will always have an impact on the local environment, it should be carried out in a way that minimises damage and avoids perpetuation of environmental injustice through effective regulation and responsible corporate practices. The public and investors are increasingly demanding that companies address environmental concerns, and failure to do so can undermine their reputation, question their social licence to operate, hinder their ability to raise capital, and even expose them to legal action.

Water needs for mining and processing critical minerals are often very high, leading to concerns about water stress and wastewater treatment. For example, producing just 1 tonne of lithium requires on average 330 m³ of water. Water needs for copper or cobalt are lower at 30 m³/tonne to 60 m³/tonne (Table 2.4). Critical minerals generally require more water than other types of heavy industry. The impact is further increased by the fact that the production of certain minerals is concentrated within already water-stressed regions, such as lithium near the Atacama Desert region.

Mining and processing of those minerals also generate large amounts of non-water waste, compared with other materials, such as iron and steel and aluminium (Nassar et al., 2022). The rock-to-metal ratio – the quantity of rock extracted and treated to produce 1 kg of metal – averages 250 kg of rock per kg of nickel, 860 for cobalt and 830 000 for platinum, compared with just 9 for iron and 7 for aluminium. This means that an Olympic swimming pool's worth of waste rock is produced for 6 kg of platinum, which is needed to produce the fuel cell components of about 50 fuel cell trucks. The rock-to-metal ratios of critical minerals are higher because their concentration in the ground is much lower. Treating and disposal of mining waste, including water, is a massive undertaking (Box 2.5).

The impact of mining operations, including cuts, tailing dams and plants, on the land is far from negligible, covering an estimated 100 000 km² of the planet's surface – an area comparable to the size of Iceland (Maus et al., 2022). There are around 1 600 mining operations in key biodiversity areas and a further 2 000 in protected areas, including 33 in world heritage sites (UNEP, 2020).

Table 2.4 Environmental impact of mining for selected minerals

	Water use (m ³ /tonne)	Share in water scarce areas (%)	Rock-to-metal ratio (tonnes/tonne)	Acidic waste (tonnes/tonne)	Share in biodiversity risk areas (%)
Coal	0.2	20%	N.A.	N.A.	25%
Iron	0.6	50%	9	N.A.	20%
Bauxite	0.4	35%	7	N.A.	17%
Nickel	53	9%	250	18	54%
Cobalt	57	6%	860	4	80%
Lithium	330	75%	1 600	2	2%
Copper	32	39%	510	67	20%
Neodymium	630	13%	N.A.	2 400	1%
Gold	N.A.	25%	3 000 000	N.A.	15%
Platinum	N.A.	80%	8 300 000	N.A.	N.A.

Notes: Ratios are for pure elements. The water use for neodymium is for REE production as a whole. The rock-to-metal ratio of lithium refers only to production from hard rock while the water use value refers to brine. Coal biodiversity risk uses thermal coal values. Share in water scarce areas represents the share of production located in countries with moderate to very high water scarcity risks according to the WWF, while share in biodiversity risk areas is based on Verisk Maplecroft data.

Sources: IEA (2021a); Nassar, et al. (2022); Eurometaux (2022); Argonne National Laboratory (2022); USGS (2009); Verisk Maplecroft (2021); WWF (2021); BP (2021).

Box 2.6 Mining waste stored behind tailings dams

Mining of minerals inevitably results in residues called tailings, including ground rock, unrecoverable and uneconomic metals, chemicals, organic matter, and effluent, which are often stored in reservoirs created by tailings dams, in the form of a slurry of fine particles. Tailings contain hazardous substances that can be highly toxic and even radioactive. Solid tailings are often used as part of the structure of the dam itself. These reservoirs are needed to prevent fine particles that result from the grinding of the rock from being released into the air and water and harming the environment.

Tailings dams, of which there are thought to be around 3 500 throughout the world, are among the largest engineered structures on earth. They are usually intended for long-term or permanent storage. Poor construction and maintenance, combined with extreme climatic events, can lead to catastrophic dam failure, such as the 2019 Brumadinho Dam disaster in Brazil, which killed more than 260 people. The failure rate of tailings dams is estimated to be two orders of magnitude higher than that of

conventional water dams (Azam & Li, 2010). Leakages are also a major risk for the environment and local populations.

More environmentally acceptable means of disposing of tailings will need to be found. Alternative solutions under development include reprocessing some of the waste or fixing it using plant life or bacteria. Dry stacking, which involves extracting water from mine waste so that it can be stored safely as dry dirt, is another possibility, though it is likely to be expensive and only practical for smaller mines in arid climates. It is also possible to recover metal from tailings which could not be extracted in the past thanks to more advanced methods.

The International Council on Mining and Metals (ICMM) established a standard on responsible tailing management with an emphasis on the respect of local communities, close monitoring of tailing facilities, transparency and preparedness in case of failure (ICMM, 2020).

References

- Adamas Intelligence (2020), Rare earth magnet market outlook to 2030.
- AHRI (Air-Conditioning, Heating, and Refrigeration Institute) (2022), Monthly shipments, <https://www.ahrinet.org/analytics/statistics/monthly-shipments>
- American Farm Bureau Federation (2021), Too many to count: Factors driving fertilizer prices higher and higher, 13 December, <https://www.fb.org/market-intel/too-many-to-count-factors-driving-fertilizer-prices-higher-and-higher>
- Argonne National Laboratory (2022), GREET model, <https://greet.es.anl.gov/>
- AskCI (2022), Analysis of the upper, middle and lower reaches of China's heat pump industry chain in 2022 (with a panoramic view of the industry chain), https://www.askci.com/news/chanye/20220823/1644171966298_6.shtml [translated]
- Azam, S., & Li, Q. (2010), Tailings dam failures: A review of the last one hundred years, Geotech News, https://www.researchgate.net/publication/265227636_Tailings_Dam_Failures_A_Review_of_the_Last_One_Hundred_Years
- Bazilian, M., Cuming, V., & Kenyon, T. (2020), Local-content rules for renewables projects don't always work, Energy Strategy Reviews, Vol. 32, 100569, <https://doi.org/10.1016/J.ESR.2020.100569>
- Beermand, V. and Vorholt, F., (2022), European battery cell production expands, VDI/VDE Innovation + Technik GmbH, Benchmark Mineral Intelligence (2022), Database.
- Bloomberg (2023), Big Solar Panel Manufacturers Boost Production as Costs Fall, Bloomberg (2022a), Commodities, <https://www.bloomberg.com/markets/commodities>
- Bloomberg (2022b), Ammonia fertilizer prices fall from record as demand eases, <https://www.bloomberg.com/news/articles/2022-04-22/ammonia-fertilizer-prices-fall-from-record-as-demand-eases?leadSource=verify%20wall>
- BNEF (BloombergNEF) (2022), 1H 2022 Hydrogen Market Outlook.
- BNEF (2022b), Lithium-ion Battery Pack Prices Rise for First Time to an Average of \$151/kWh, <https://about.bnef.com/blog/lithium-ion-battery-pack-prices-rise-for-first-time-to-an-average-of-151-kwh/>
- BNEF (2021a), Global Lithium Outlook 2021-2030.
- BNEF (2021b), 2021 Global Wind Turbine Market Shares report.
- BNEF (2021c), Wind Trade and Manufacturing: A Deep Dive.
- BNEF (2020), Global Nickel Outlook 2020-2030.
- BNN Bloomberg (2022), China's Wind Turbines Get Ever Cheaper as Price War Hits Profits, <https://www.bnnbloomberg.ca/china-s-wind-turbines-get-ever-cheaper-as-price-war-hits-profits-1.1852856>
- BP (2021), Statistical Review of World Energy July 2021, <https://www.bp.com/en/global/corporate/energy-economics/statistical-review-of-world-energy.html>
- BSRIA (2020), BSRIA's view on refrigerant trends in AC and heat pump segments, https://www.bsria.com/us/news/article/bsrias_view_on_refrigerant_trends_in_ac_and_heat_pump_segments/

- CEMAC (Clean Energy Manufacturing) (2020), Refrigerants: Market Trends and Supply Chain Assessment.
- Cheng, J. (2022), Importance of energy standards in supporting affordable growth of the high efficiency heat pump market in China, 8th IEA-Tsinghua Workshop, <https://www.iea.org/events/the-8th-iea-tsinghua-joint-workshop-making-buildings-zero-carbon-ready-by-2030-near-term-solutions-for-heating-systems>
- China, MIIT (Ministry of Industry and Information Technology) (2022), Operation of the steel industry in the first half of 2022, https://www.miit.gov.cn/gxsj/tjfx/yclgy/gt/art/2022/art_0e2f9083cc484800a09d22792d561cc9.html
- China, MIIT (Ministry of Industry and Information Technology) (2015), Announcement on "Regulations for Automotive Power Battery Industry", https://www.miit.gov.cn/zwgk/zcwj/wjfb/tg/art/2020/art_3aa31303ce75453ba93963f57032538d.html
- China, MIIT (2019), Announcement No. 22 [2019] of the Ministry of Industry and Information Technology of the People's Republic of China, https://www.miit.gov.cn/jgsj/zbys/wjfb/art/2020/art_17737242b022456bab3b8667cd3c70a9.html
- China, MIIT (2015), Announcement on "Regulations for Automotive Power Battery Industry", https://www.miit.gov.cn/zwgk/zcwj/wjfb/tg/art/2020/art_3aa31303ce75453ba93963f57032538d.html
- China, MIIT (2022), Operation of the steel industry in the first half of 2022, https://www.miit.gov.cn/gxsj/tjfx/yclgy/gt/art/2022/art_0e2f9083cc484800a09d22792d561cc9.html
- Chinabaogao (2022), Statistics on domestic sales, domestic revenue and market share of air source heat pump enterprises in China, <https://www.chinabaogao.com/data/202208/606704.html>
- DeepMind (2019), Machine learning can boost the value of wind energy, <https://www.deepmind.com/blog/machine-learning-can-boost-the-value-of-wind-energy>
- E4tech (2022), Database, <https://www.e4tech.com/>
- ECECP (EU-China Energy Cooperation Platform) (2022), Comparative study on policies for products' energy efficiency in EU and China.
- EHPA (European Heat Pump Association) (2022), Market data, <https://www.ehpa.org/market-data/>
- Emilsson, E., & Dahllöf, L. (2019), Lithium-ion vehicle battery production, <https://www.ivl.se/download/18.14d7b12e16e3c5c36271070/1574923989017/C444.pdf>
- ETIP Wind (2016), When wind goes digital, <https://etipwind.eu/wp-content/uploads/When-Wind-Goes-Digital.pdf>
- EU (European Union) (2021), Commission implementing regulation (EU) 2021/2239 imposing a definitive anti-dumping duty on imports of certain utility scale steel wind towers originating in the People's Republic of China, <https://eur-lex.europa.eu/legal-content/EN/TXT/PDF/?uri=CELEX:32021R2239&from=EN>
- EU (2020), Amending Regulation (EU) No 1387/2013 suspending the autonomous Common Customs Tariff duties on certain agricultural and industrial products, <https://eur-lex.europa.eu/legal-content/EN/TXT/?uri=CELEX:32020R2231>

- Eurometaux (2022), Metals for Clean Energy: Pathways to Solving Europe's Raw Materials Challenge, <https://www.eurometaux.eu/media/jmxf2qm0/metals-for-clean-energy.pdf>
- Eurostat (2022), EU trade since 1988 by HS2-4-6 and CN8, <https://ec.europa.eu/eurostat/databrowser/bookmark/ae0dff9b-fd26-4108-87ce-1395c5627475?lang=en&page=time:2021>
- EV Volumes (2022), The electric vehicle world sales database, <https://www.ev-volumes.com/>
- Fleischmann, J. et al. (2021), Unlocking growth in battery cell manufacturing for electric vehicles, McKinsey, <https://www.mckinsey.com/capabilities/operations/our-insights/unlocking-growth-in-battery-cell-manufacturing-for-electric-vehicles>
- GE (2015), Wind in the cloud? How the digital wind farm will make wind power 20 percent more efficient, <https://www.ge.com/news/reports/wind-in-the-cloud-how-the-digital-wind-farm-will-2>
- Geyer, R., Jambeck, J., & Law, K. (2017), Production, use, and fate of all plastics ever made, Science Advances, Vol. 3/7, <https://doi.org/10.1126/sciadv.1700782>
- Goldwind (2021), Goldwind Sustainability Report 2021, https://www.goldwindamericas.com/sites/default/files/2021_Goldwind%20Sustainability%20Report.pdf
- Government of China (2014), Guiding Opinions of the General Office of the State Council on Accelerating the Promotion and Application of New Energy Vehicles, http://www.gov.cn/zhengce/content/2014-07/21/content_8936.htm
- Government of China (2013), Notice on Continuing the Promotion and Application of New Energy Vehicles, http://www.gov.cn/zwqk/2013-09/17/content_2490108.htm
- Government of India (2022), Index of Industrial Production, Ministry of Statistics and Programme Implementation, <https://mospi.gov.in/web/mospi/download-tables-data/-/reports/view/templateFour/23802?q=TBDCAT>
- GRV (Global Research View) (2022), Global Heat Pump Industry, Analysis & Competition Research (2022-2029).
- Hongyue Jin, et al. (2018), Life cycle assessment of neodymium-iron-boron magnet-to-magnet recycling for electric vehicle motors, Environmental Science & Technology, Vol. 52/6, pp. 3796–3802, <https://pubs.acs.org/doi/10.1021/acs.est.7b05442>
- HPTCJ (Heat Pump and Thermal Storage Technology Centre of Japan) (2022), About heat pump water heater, <https://www.hptcj.or.jp/e/learning/tabid/370/Default.aspx>
- IAI (International Aluminium Institute) (2022), Current statistics, <https://international-aluminium.org/>
- ICMM (International Council on Mining and Metals) (2020), Global industry standard on tailings management, <https://www.icmm.com/website/publications/pdfs/environmental-stewardship/2020/global-industry-standard-on-tailings-management.pdf>
- IEA (2022a), Global Hydrogen Review 2022, <https://www.iea.org/reports/global-hydrogen-review-2022>
- IEA (2022b), Solar PV Global Supply Chains, <https://www.iea.org/reports/solar-pv-global-supply-chains>
- IEA (2022c), World Energy Balances, <https://www.iea.org/data-and-statistics/data-product/world-energy-balances>
- IEA (2022d), Global EV Outlook 2022, <https://www.iea.org/reports/global-ev-outlook-2022>

- IEA (2022e), World Energy Investment 2022, <https://www.iea.org/reports/world-energy-investment-2022>
- IEA (2022f), How the energy crisis is exacerbating the food crisis, <https://www.iea.org/commentaries/how-the-energy-crisis-is-exacerbating-the-food-crisis>
- IEA (2022g), The Future of Heat Pumps, <https://www.iea.org/reports/the-future-of-heat-pumps>
- IEA (International Energy Agency) (2021a), The Role of Critical Minerals in Clean Energy Transitions, <https://iea.blob.core.windows.net/assets/ffd2a83b-8c30-4e9d-980a-52b6d9a86fdc/TheRoleofCriticalMineralsinCleanEnergyTransitions.pdf>
- IEA (2021b), Ammonia Technology Roadmap, <https://www.iea.org/reports/ammonia-technology-roadmap>
- IEA (2021c), Enhancing cyber resilience in electricity systems, <https://www.iea.org/reports/power-systems-in-transition/cyber-resilience>
- IFA (International Fertilizer Association) (2022), International Fertilizer Association short-term fertilizer outlook 2022-2023, <https://api.ifastat.org/reports/download/13806>
- InfoLink (2022), InfoLink online database, <https://www.infolink-group.com/index/en>
- JRAIA (Japan Refrigeration and Air Conditioning Industry Association) (2022), Voluntary statistics, <https://www.jraia.or.jp/statistic/>
- Lambert, F. (2022), Tesla (TSLA) significantly increases its electric car prices across its lineup, Electrek, 15 June, <https://electrek.co/2022/06/15/tesla-tsla-increases-electric-car-prices-across-lineup/>
- Le Gleuher, M. (2021), Le sulfate de nickel : un ingrédient clé des batteries Li-ion [Nickel sulfate : a key ingredient in Li-ion batteries], Minéral Info, 5 August, <https://www.mineralinfo.fr/fr/ecomine/sulfate-de-nickel-un-ingredient-cle-des-batteries-li-ion>
- Lyons, L. et al. (2022), Clean Energy Technology Observatory: Heat Pumps in the European Union – 2022 Status Report on Technology Development, Trends, Value Chains and Markets, JRC, <https://publications.jrc.ec.europa.eu/repository/handle/JRC130874>
- Maus, V. et al. (2022), An update on global mining land use, Scientific Data, Vol. 9, <https://www.nature.com/articles/s41597-022-01547-4>
- McKinsey (2022), The semiconductor decade: A trillion-dollar industry, <https://www.mckinsey.com/industries/semiconductors/our-insights/the-semiconductor-decade-a-trillion-dollar-industry>
- Nassar, N.T. et al. (2022), Rock-to-metal ratio: A foundational metric for understanding mine wastes, Environmental Science & Technology, Vol. 56/10, pp. 6710–6721, <https://pubs.acs.org/doi/10.1021/acs.est.1c07875>
- Naumann, G., Schropp, E. & Gaderer, M. (2022), Life cycle assessment of an air-source heat pump and a condensing gas boiler using an attributional and a consequential approach, Procedia CIRP, Vol. 105, pp. 351-356, <https://www.sciencedirect.com/science/article/pii/S2212827122000580>
- OICA (Organization of Motor Vehicle Manufacturers) (2022), Global Sales Statistics 2019 – 2021, <https://www.oica.net/category/sales-statistics/>
- PIIE (Peterson Institute for International Economics) (2021), Local content requirements threaten renewable energy uptake, <https://www.piie.com/blogs/trade-and-investment-policy-watch/local-content-requirements-threaten-renewable-energy-uptake>

- Platts (2022), Global Olefins Outlook.
- Reuters (2022), Ford raises prices of electric F-150 pickup amid high commodity costs, 9 August, <https://www.reuters.com/business/autos-transportation/ford-raises-prices-electric-f-150-pickup-amid-high-commodity-costs-2022-08-09/>
- Royal Society (2020), Green ammonia policy briefing, <https://royalsociety.org/-/media/policy/projects/green-ammonia/green-ammonia-policy-briefing.pdf>
- Saoud, A., Harajli, H., Manneh, R. (2021), Cradle-to-grave life cycle assessment of an air to water heat pump: Case study for the Lebanese context and comparison with solar and conventional electric water heaters for residential application, <https://www.sciencedirect.com/science/article/pii/S2352710221011116>
- Schlömer, S., Bruckner, T., Fulton, L., Hertwich, E., McKinnon, A., Perczyk, D., Roy, J., Schaeffer, R., Sims, R., Smith, P., & Wisser, R. (2014), Annex III: Technology-specific cost and performance parameters. In O. Edenhofer, R. PichsMadruga, Y. Sokona, J.C. Minx, E. Farahani, S. Kadner, K. Seyboth, A. Adler, I. Baum, S. Brunner, P. Eickemeier, B. Kriemann, J. Savolainen, S. Schlömer, C. VonStechow, T. Zwickel, & J. C. Minx (Eds.), *Climate Change 2014: Mitigation of Climate Change: Contribution of Working Group III to the Fifth Assessment Report of the Intergovernmental Panel on Climate Change* (pp. 1329-1356). Cambridge University Press. https://www.ipcc.ch/site/assets/uploads/2018/02/ipcc_wg3_ar5_annex-iii.pdf
- S&P Global (2022a), Lithium and cobalt global supply-demand balance, January 2022.
- S&P Global (2022b), Commodity prices.
- S&P Global (2020), Analysis: China's steel inventories triple on year to 100 mil mt, posing big challenge for Q2, <https://www.spglobal.com/commodityinsights/en/market-insights/latest-news/metals/032320-analysis-chinas-steel-inventories-almost-triple-on-year-to-100-mil-mt-posing-big-challenge-for-q2>
- SIA (Semiconductor Industry Association) (2022a), Global semiconductor sales, units shipped reach all-time highs in 2021 as industry ramps up production amid shortage, 14 February, <https://www.semiconductors.org/global-semiconductor-sales-units-shipped-reach-all-time-highs-in-2021-as-industry-ramps-up-production-amid-shortage/>
- SIA (2022b), State of the US semiconductor industry, <https://www.semiconductors.org/wp-content/uploads/2021/09/2021-SIA-State-of-the-Industry-Report.pdf>
- SIA (2022c), 2022 Factbook, https://www.semiconductors.org/wp-content/uploads/2022/05/SIA-2022-Factbook_May-2022.pdf
- Siemens Gamesa (2021), Consolidated Non-Financial Statement 2021, <https://www.siemensgamesa.com/en-int/-/media/siemensgamesa/downloads/en/sustainability/siemens-gamesa-consolidated-non-financial-statement-2021-en.pdf>
- Sohu (2022), Sichuan issued a document to ensure electricity for people's livelihood, and all industrial power users in the plan will stop production for 6 days, https://www.sohu.com/a/577018216_260616
- Thomson Reuters (2022), Chemical products and capacities' online database, <https://www.thomsonreuters.com/en.html>

- Thyssenkrupp (2020), Thyssenkrupp's water electrolysis technology qualified as primary control reserve – E.ON and thyssenkrupp bring hydrogen production to the electricity market, <https://www.thyssenkrupp.com/en/newsroom/press-releases/pressdetailpage/thyssenkrupps-water-electrolysis-technology-qualified-as-primary-control-reserve--eon-and-thyssenkrupp-bring-hydrogen-production-to-the-electricity-market-83355>, accessed November 2022
- TSMC (Taiwan Semiconductor Manufacturing Company) (2021), TSMC 2021 Sustainability Report highlights, https://esg.tsmc.com/download/file/2021_SustainabilityReportHighlights/english/e-all.pdf
- UN (United Nations) (2022a), Comtrade Database, <https://comtradeplus.un.org/>
- UN (2022b), Amendment to the Montreal Protocol on Substances that Deplete the Ozone Layer, https://treaties.un.org/Pages/ViewDetails.aspx?src=IND&mtdsg_no=XXVII-2-f&chapter=27&clang=en
- UNECE (United Nations Economic Commission for Europe) (2021), Life Cycle Assessment of Electricity Generation Options, <https://unece.org/sites/default/files/2021-10/LCA-2.pdf>
- UNEP (United Nations Environment Programme) (2020), Mineral Resource Governance in the 21st Century, <https://wedocs.unep.org/handle/20.500.11822/31641>
- UN FAO (Food and Agriculture Organization) (2022), World Food Situation: FAO Food Price Index, <https://www.fao.org/worldfoodsituation/foodpricesindex/en/>
- United Kingdom, Department for Business, Energy & Industrial Strategy (2020), Heat Pump Manufacturing Supply Chain Research Project, https://assets.publishing.service.gov.uk/government/uploads/system/uploads/attachment_data/file/943712/heat-pump-manufacturing-supply-chain-research-project-report.pdf
- US DOE (United States Department of Energy) (2022a), Land-Based Wind Market Report: 2022 Edition.
- US DOE (2022b), Semiconductor Supply Chain Deep Dive Assessment, <https://www.energy.gov/sites/default/files/2022-02/Semiconductor%20Supply%20Chain%20Report%20-%20Final.pdf>
- US DOE (2009), American Recovery and Reinvestment Act of 2009, <https://afdc.energy.gov/laws/arra.html>
- US EIA (United States Energy Information Agency) (2022), Oil and petroleum products explained, <https://www.eia.gov/energyexplained/oil-and-petroleum-products/imports-and-exports.php>
- USGS (United States Geological Survey) (2022), Mineral Commodity Summaries 2022, <https://pubs.usgs.gov/periodicals/mcs2022/mcs2022.pdf>
- USGS (2009), Methods for Estimating Water Withdrawals for Mining in the United States, 2005, <https://pubs.er.usgs.gov/publication/sir20095053>
- USITC (United States International Trade Commission) (2021), The Evolution of Global Onshore Wind Turbine Blade Production and Trade, https://www.usitc.gov/publications/332/executive_briefings/ebot-the_evolution_of_global_onshore_wind_turbine_blade_production_and_trade.pdf
- USITC (2022), Chinese Wind Turbine Export Growth Continued in 2021, https://www.usitc.gov/publications/332/executive_briefings/ebot_chinese_wind_turbine_export_growth_continued_in_2021.pdf

- Varas, A., Varadarajan, R., Goodrich, J. & Yinug, F. (2020), Government incentives and US competitiveness in semiconductor manufacturing, BCG & SIA, <https://www.semiconductors.org/wp-content/uploads/2020/09/Government-Incentives-and-US-Competitiveness-in-Semiconductor-Manufacturing-Sep-2020.pdf>
- Verisk Maplecroft (2021), Mining operations face growing biodiversity risks, <https://www.maplecroft.com/insights/analysis/mining-operations-face-growing-biodiversity-risks/>
- Vestas (2021), Sustainability Report 2021, https://www.vestas.com/content/dam/vestas-com/global/en/investor/reports-and-presentations/financial/2021/Sustainability_Report_2021.pdf.coredownload.inline.pdf
- WBMS (World Bureau of Metal Statistics) (2022), World Metal Statistics Yearbook.
- Wind Europe (2021), Wind energy digitalisation towards 2030, <https://windeurope.org/intelligence-platform/product/wind-energy-digitalisation-towards-2030/>
- WISE Uranium Project (2020), Uranium maps and statistics, <http://www.wise-uranium.org/umaps.html>
- Wood Mackenzie (2022), Wind turbine blades supply chain trends 2022, Global Wind Energy Supply Chain Series, p. 7.
- Worldsteel (2022a), 2022 world steel in figures, <https://worldsteel.org/wp-content/uploads/World-Steel-in-Figures-2022.pdf>
- Worldsteel (2022b), Monthly crude steel and iron production statistics, <https://worldsteel.org/publications/bookshop/monthly-subscription-1/>
- WWF (World Wide Fund for Nature) (2021), WWF Water Risk Filter, <https://waterriskfilter.org/>
- Yoon, J. (2021), Smarter cars intensify race to get the top chips, Financial Times, 7 December, <https://www.ft.com/content/0f70afa6-1a14-4a9f-8f2f-f7e31bbb274a>

Chapter 3. Mining and material production

Highlights

- Clean energy transitions require substantial material inputs. Critical minerals (notably lithium, cobalt, nickel, copper and neodymium) and bulk materials (steel, cement, plastics and aluminium) are required for a range of technologies and infrastructure, from wind turbines and EV batteries to electricity grids. Demand for each of the five key critical minerals increases 1.5 to 7 times by 2030 in the Net Zero Emissions by 2050 (NZE) Scenario as clean technology deployment soars. Greater material efficiency across all demand segments can more than offset increased steel and cement demand for clean energy technologies and infrastructure.
- Mining capacity for critical minerals needs to expand swiftly to get on track with net zero goals. While current anticipated investments will lead to substantial gains, capacity would still fall well short of global NZE Scenario needs in 2030. The largest gap is for lithium, with anticipated expansions covering just two-thirds of 2030 requirements. Lead times for new mines are long and uncertain, meaning that investment of around USD 360-450 billion would be needed mostly over the next three years to bridge this gap.
- Capacity to process these minerals into usable materials must also expand considerably. Currently anticipated projects point to large supply gaps for some critical materials unless new plans are announced soon, regardless of whether mining capacity is sufficient. The current announcements imply shortfalls of 60% for nickel sulphate and 35% for lithium, relative to what is needed in the NZE Scenario by 2030. Geographic diversification could reduce the risk of supply disruptions, but current expansion plans point to continued dominance by China.
- Conventional bulk material production capacity is emissions-intensive and very difficult to decarbonise. Most near zero emission production routes are not yet commercially available, but must expand from minimal quantities of output today to around 130 million tonnes (Mt) of primary steel and 370 Mt of cement production by 2030 in the NZE Scenario. Among announced projects, those we assess as likely to achieve near zero emission production immediately yield just 10% of NZE Scenario needs for primary steel in 2030 and 3% for cement. These projects are mainly in Europe and North America, but demand grows most in emerging markets and developing economies, pointing to the need for increased international co-operation.

Material needs for net zero emissions

The new clean energy economy depicted in the Net Zero Emissions by 2050 (NZE) Scenario requires a massive expansion of the supply chains needed to manufacture the equipment for clean energy technologies on a large scale and to build supporting infrastructure. The task is complicated by the fact that many clean energy technologies and infrastructure rely on critical materials, the supply of which may be challenging to scale up quickly. On balance, the transition to clean energy technologies will reduce the total mass of resources – including both energy and materials – entering the energy system, despite a large increase in demand for some critical materials¹⁸ (Figure 3.1). This will be driven largely by a change in the form of much of the energy inputs, as primary energy flows increasingly originate directly from the energy in solar radiation and wind, instead of the chemical bonds in mass-based solid, liquid or gaseous fossil fuels.

In the NZE Scenario, the mass of resources entering the energy system in 2050 is about half that of today. Biomass accounts for about 45% of the mass inputs in 2050, materials needed to build and sustain clean energy assets for about 35%, and fossil fuels for the rest (of which about half is consumed in facilities equipped with carbon capture, utilisation and storage [CCUS] and around 20% is used for feedstock). Most of the mass reductions relative to today come from reduced fossil fuel use. For example, six times more coal than steel (in mass terms) enters the energy system at present; by 2050, steel inputs are roughly double that of coal.

The material needs of clean energy technology supply chains, and of the economy more broadly, face two crucial challenges in the NZE Scenario: supply and emissions. Meeting the growth in demand for critical materials, which requires a massive expansion of mines to extract raw minerals and plants to process minerals into final materials, is a massive undertaking. Given the long lead times involved, especially in developing new mines, early planning would be needed. Production of both critical and bulk materials is very energy- and carbon-intensive today. Those supply chains are rapidly decarbonised in that scenario to be compatible with the global net zero trajectory.

¹⁸ In this chapter, the “energy system” includes devices that directly produce or consume energy (e.g. solar panels and motors), equipment and structures that house energy-consuming devices and in turn can passively impact energy consumption (e.g. building envelopes and car bodies), infrastructure that directly transports energy or CO₂ (e.g. electricity grids and CO₂ pipelines), and infrastructure whose build-out could be directly affected by shifts in technology due to clean energy transitions (e.g. rail infrastructure and roads).

Figure 3.1 Global mass-based resource flows into the energy system in the NZE Scenario, 2050

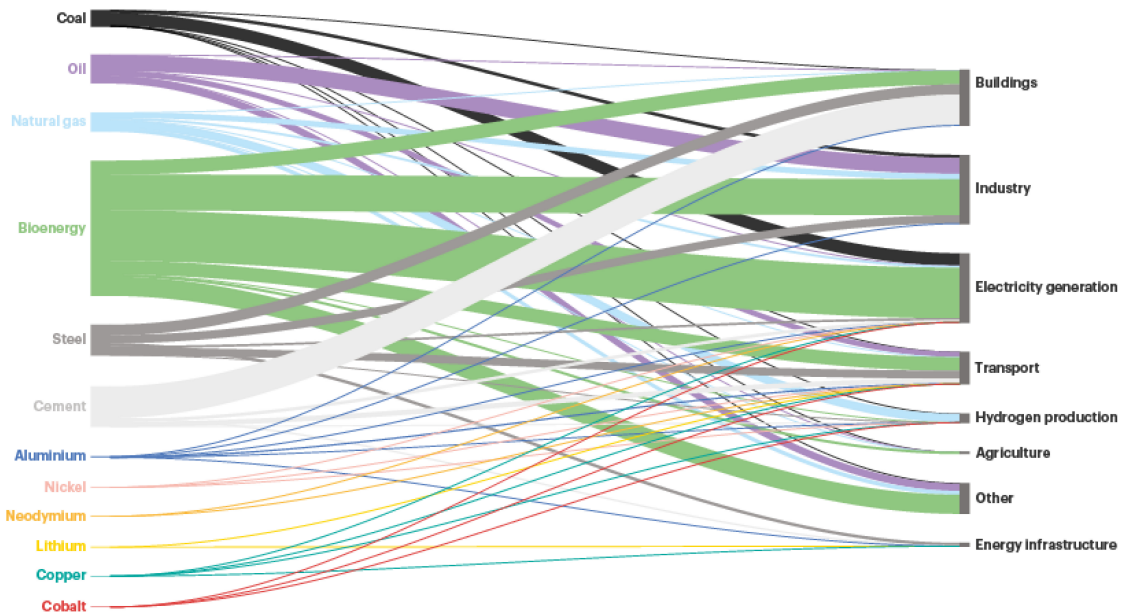

IEA. CC BY 4.0.

Notes: Physical mass flows of fuels and materials in the energy system, in million tonnes. See footnote 1 above for a detailed definition of the energy system. Critical materials include copper, lithium, nickel, cobalt and neodymium. Industry material demand includes that from industrial equipment but not the plant shell. The equivalent graph for 2021 is in Chapter 1.

The mass of resources used in the energy system in 2050 in the NZE Scenario is about half that of today. Materials account for about one-third of the inputs in 2050.

The remainder of this section goes into more detail about demand for materials in the NZE Scenario, as well as the material efficiency measures that reduce total demand for materials and optimise material use to minimise supply chain pressures. The subsequent sections assess mineral extraction and material production in more depth, looking into how the expansion of supply and reductions in CO₂ emissions can be achieved at each of these steps in clean energy supply chains.

Box 3.1 Clarifying materials-related terminology

We distinguish between two main steps in the supply chain related to materials: **mineral extraction/mining** and **material production**. Minerals are extracted from the earth in the form of mineral ores – naturally occurring rocks or sediments that contain the relevant mineral in sufficient concentrations for economical extraction (ores are often composed of several different minerals). Ores are usually upgraded at the mine to liberate and concentrate the minerals of interest. The material production step involves the further processing of these minerals in industrial

plants to achieve the chemical composition required for use. This may involve extracting a pure metal in elemental form, or processing into a desired alloy or mineral compound. Given the division into these two main steps, we use “minerals” to refer to what is extracted at mines, measured in terms of the target element contained within mineral ores, and “materials” for what is produced at industrial plants for later use.

We also distinguish between two main groups of materials (and the minerals they are derived from them):

- **Critical:** These are materials that are important for clean energy technologies and infrastructure and that could face supply gaps if sufficient efforts are not taken to scale up supply. The volumes of critical materials tend to be small relative to other materials (current global production of each type of critical material is well under 100 Mt per year). Demand from clean energy transitions could drive a very rapid increase in total demand.
- **Bulk:** These are large-volume materials produced in quantities approaching or exceeding 100 Mt per year globally. They differ from critical materials in that clean energy transitions are not anticipated to pose a risk of supply gaps, as the raw minerals needed to make them are comparatively widespread and abundant. They are already widely used in energy and other sectors so clean energy transitions are not expected to lead to a large overall increase in total demand.

While various materials could technically fit under each category, in this chapter we focus on those critical materials that are particularly important for making clean energy technologies, and the bulk materials that are currently most energy- and emissions-intensive and that are needed for clean energy technologies and infrastructure (Table 3.1).

Table 3.1 Leading minerals and materials for clean energy supply chains by type

	Minerals	Materials
Critical	<ul style="list-style-type: none"> • copper contained in ores • lithium contained in ores (or brine) • nickel contained in ores • cobalt contained in ores • neodymium contained in ores 	<ul style="list-style-type: none"> • copper • lithium (and its compounds) • nickel (and its compounds) • cobalt (and its compounds) • neodymium • polysilicon
Bulk	<ul style="list-style-type: none"> • iron contained in ores (to produce steel) • aluminium contained in ores 	<ul style="list-style-type: none"> • steel • cement • aluminium • plastics

Notes: Minerals and raw resources that are used to produce some of the materials shown in the table and that are extracted but not mined are excluded from this analysis, due to their much lower emissions intensity in the case of quarrying, or the very different nature of extraction in the case of energy raw materials. This includes limestone that is quarried for cement production and oil from which plastics are derived (see Chapter 1). Quartz and other minerals from which polysilicon is derived are excluded due to a lack of reliable data on energy intensity and the low risk of supply gaps.

Material demand

The evolution of the demand for materials that go into making clean energy technologies and infrastructure in the NZE Scenario is driven by a range of factors that fall into two main categories: those that affect total activity and those that affect the material intensity of activity. The primary determinants of activity are the overall demand for particular energy services in end use sectors and the mix of technologies used to meet that demand. For example, total passenger vehicle sales are curbed in that scenario by switching to other modes of transport, while the share of EVs in total vehicle sales increases rapidly. The result is that total electricity demand grows considerably due to increasing electrification of road vehicles as well as other sectors, while the share of wind and solar PV energy in power generation expands.

With regard to material intensity, innovation progressively reduces the overall material intensity of clean energy technologies and infrastructure in the NZE Scenario. For example, the amount of metal required per unit of stored energy in batteries declines steadily as their energy density increases, thanks to technical advances in chemistry. Innovation also reduces the relative amounts of critical materials – which can be expensive and are more at risk of supply disruptions – needed for a range of clean energy technologies. For instance, innovative catalysts are already reducing the need for platinum group metals in electrolysers, while the future use of innovative perovskite solar PV technologies could reduce demand for energy-intensive polysilicon – one of the main material inputs to PV cell production today. Material efficiency measures also reduce the overall material intensity of economic activity, including that of clean technologies, while providing the same service. In many cases, this involves reduced overall demand for materials, though in some cases it can increase reliance on certain materials that reduce the life-cycle emissions of a given technology (for example, lighter materials used in vehicles improve fuel economy).

In terms of material demand, the impact of clean energy transitions is most pronounced for critical materials. Gains in material efficiency are more than offset by the rapid pace of deployment of clean energy technologies and infrastructure in the NZE Scenario. Already by 2030, global clean energy technology and infrastructure¹⁹ demand for each of five main critical materials – copper, lithium, cobalt, nickel and neodymium – is between 3 and 14 times higher than in 2021, depending on the material, such that combined demand for these materials grows

¹⁹ In the context of this chapter, estimates of material demand from “clean energy technologies and infrastructure” are based on a selection of technologies and infrastructure that account for much of the additional demand for critical and bulk materials due to clean energy transitions. The technologies and infrastructure included are as follows: renewable and nuclear power generation, electricity grids, EV batteries and motors, hydrogen production and fuel cells in fuel cell electric vehicles, and infrastructure for hydrogen distribution and CO₂ transport and storage. Other components of the “energy system” (as defined in footnote 1) – such as car bodies, building envelopes and rail infrastructure – are not included in this category.

from 6 Mt to 20 Mt. This pushes up total demand from all uses for each of these materials by between 1.5 and 8 times, such that combined demand grows from 26 Mt to 43 Mt (Figure 3.2).

Figure 3.2 Total global material demand by type in the NZE Scenario

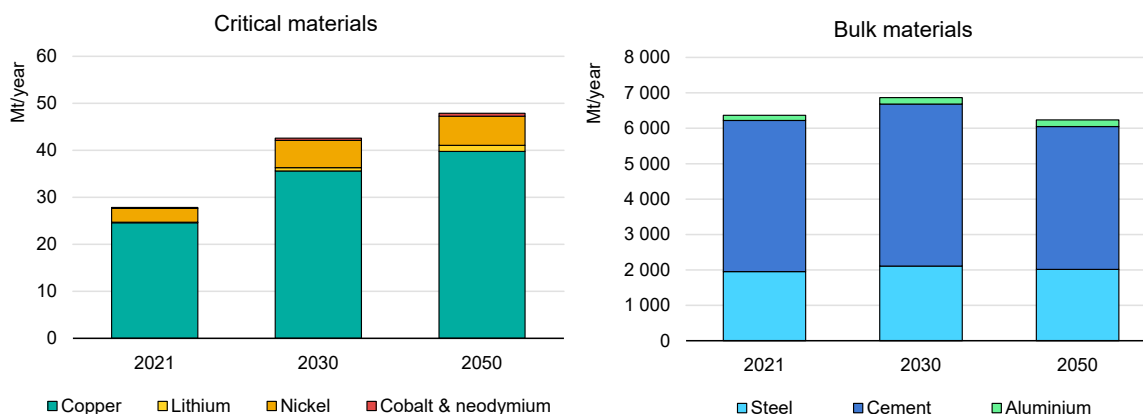

IEA. CC BY 4.0.

Source: IEA analysis based on USGS (2022).

In the NZE Scenario, deployment of clean energy technologies rapidly increases demand for critical materials, while material efficiency curbs growth in demand for bulk materials.

After 2030, growth in demand for most critical minerals is much more modest, even as the in-use stocks of these materials continue to grow rapidly. In the NZE Scenario, technology deployment rates must accelerate quickly this decade. In some cases, deployment rates reach sufficiently high levels already by around 2030, and then those rates are maintained at similar levels throughout the rest of the scenario. For example, combined wind and solar PV capacity additions quadruple from about 250 GW per year today to 1 000 GW in 2030, as fossil-based power capacity is rapidly replaced. The annual rate of additions is then sustained at around 1 000 GW through to 2050, in order to meet increasing demand for electricity from decarbonising end-use sectors – as such, the total installed capacity of wind and solar increases by three times from 2030 to 2050. Material substitution and improved efficiency also play a role in limiting the increase in material demand. This is the case for EVs, where the rate of deployment continues to grow even after 2030 – sales of passenger electric cars are nearly 70% higher in 2050 than 2030. However, through innovation to increase battery density and switching to battery chemistries reliant on materials with lower supply risks, demand for cobalt and nickel grows at a considerably slower pace than for lithium over that period.

In the Announced Pledges Scenario (APS), which reflects current government ambitions, clean technologies are deployed more slowly than in the NZE Scenario. This leads to a slower increase in demand for critical materials. Between 2021 and

2030, combined demand for critical materials grows at around 3.3% annually in the APS, only a moderate increase compared with the 2.7% annual growth observed over the last decade, and considerably lower than the 4.8% annual increase required to 2030 in the NZE Scenario. Between 2030 and 2050, demand for most critical minerals grows only modestly in the NZE Scenario. In contrast, in the APS demand growth continues more strongly after 2030 and eventually meets similar levels as in the NZE. Actual future demand will be determined by the extent to which public- and private-sector actors are able to meet their current emissions reduction ambitions through deploying clean energy technologies, or even exceed such ambitions in an effort to keep global warming to 1.5°C.

Clean energy technologies and infrastructure – in particular EV batteries, electricity generation and grids, and low-emission hydrogen production – are the main drivers of increasing demand for critical materials in the NZE Scenario over the period to 2050 (Figure 3.3). While the specific technology driver varies by material, clean technologies account for a growing share of total demand for all critical materials. The share of EV and grid storage batteries in total global lithium demand rises from 45% in 2021 to almost 90% in 2030. For copper, the share going to renewable power generation, EVs and power networks rises from about 25% to 45%. For nickel, demand growth from EVs, power generation and electrolysers outpaces that from most other nickel end uses, such that their share of demand reaches close to 60% in 2030, compared with only 10% today and less than 5% just a decade ago.

Total demand for lithium increases most rapidly, sevenfold between 2021 and 2030. This is largely driven by its important role in EV batteries, for which there are few alternatives, since demand for EVs soars over that period. Demand for copper, the leading metal in volume terms among all the critical minerals, increases 45% – the smallest increase in percentage terms among the five metals, but the biggest in absolute terms (just over 1 Mt per year on average to 2030), 90% of which is directly driven by clean energy technologies, essentially electricity networks, EVs, solar PV and wind turbines.

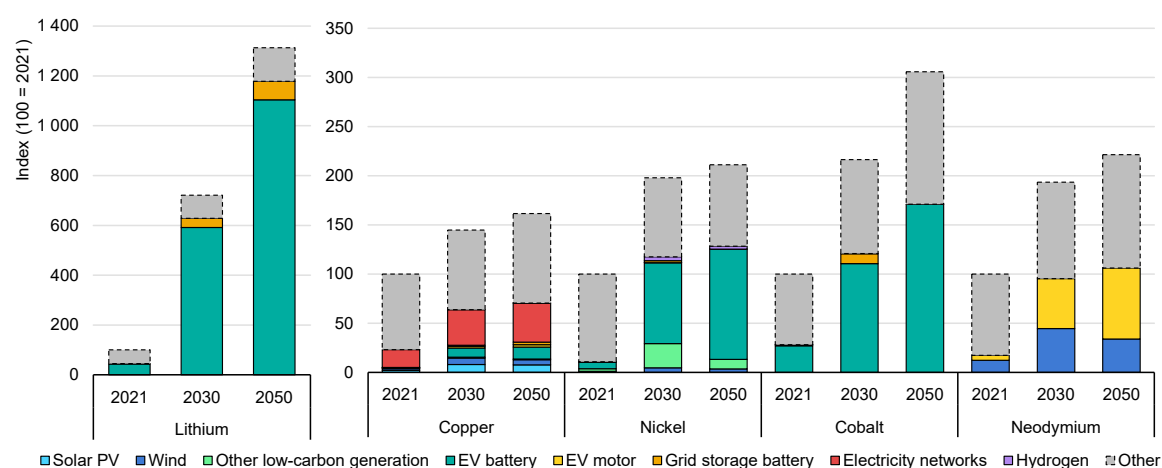
Figure 3.3 Global critical material demand by end use in the NZE Scenario

IEA. CC BY 4.0.

Demand for critical materials increases rapidly in the NZE Scenario, driven mainly by clean energy technologies and infrastructure.

Clean energy technologies and infrastructure are expected to lead to growing demand for some bulk materials in specific segments – for example, aluminium for solar panel frames and steel for wind turbines. However, total global demand for bulk materials does not jump rapidly in the NZE Scenario in the way it does for critical materials (Figure 3.4). Demand for cement and steel largely stagnates, while demand for aluminium and plastics continues to grow although at much lower rates than critical materials.

For cement and steel, clean energy technologies and infrastructure account for only a relatively small portion of total demand. For example, electricity generation – including for fossil, nuclear and renewable technologies – today accounts for only about 2-3% of cement and steel demand. In the NZE Scenario, demand from electricity generation for steel nearly triples and for cement doubles by 2030, but this still equates to only about 5% of total demand for each. Meanwhile, demand for both cement and steel from energy infrastructure – that is, combined demand from electricity grids, oil and gas pipelines, hydrogen pipelines, and CO₂ transport and storage – roughly doubles between now and 2050 in the NZE Scenario, even as demand from oil and gas pipelines in particular declines sharply. Yet in 2050 this segment still accounts for only about 7% of total steel and less than 2% of total cement demand.

Instead, the main drivers of overall demand for cement and steel come from other demand segments, including construction for both materials and manufacturing of vehicles and consumer goods for steel. Per capita demand for bulk materials tends to level off and even decrease as economies reach maturity, as demand comes mainly from replacing and repairing existing stocks of goods and products, rather

than building or making new ones. Much of growth in demand for these materials in the emerging market and developing economies is offset by a gradual decline in demand in the advanced economies and even some emerging market economies, leading to relatively flat global demand to 2050 in the NZE Scenario. Material efficiency measures also play a key role in curbing overall global demand (see below).

The story for aluminium is somewhat different. Electricity generation and grids today account for about 10% of aluminium demand. This demand more than doubles by 2050 in the NZE Scenario, and is one of the central drivers of increasing total aluminium demand. The transport sector also has a major impact, as vehicles account for about a quarter of today’s aluminium demand. This demand segment grows by about 60% by 2050 in the NZE Scenario, due to a combination of vehicle lightweighting to improve fuel economy and facilitate smaller batteries in EVs, and increasing penetration of EVs that rely more on aluminium than conventional vehicles. Even after material efficiency measures reduce demand from other segments, these changes together result in about a 35% increase in total aluminium demand by 2050. Similarly, the demand drivers for plastics – including a large role from packaging and consumer goods – lead to moderately increasing demand to 2050 despite material efficiency measures. Still, the increases seen for aluminium and plastics are considerably lower than that of critical materials.

Figure 3.4 Estimated global bulk material demand by end use in the NZE Scenario

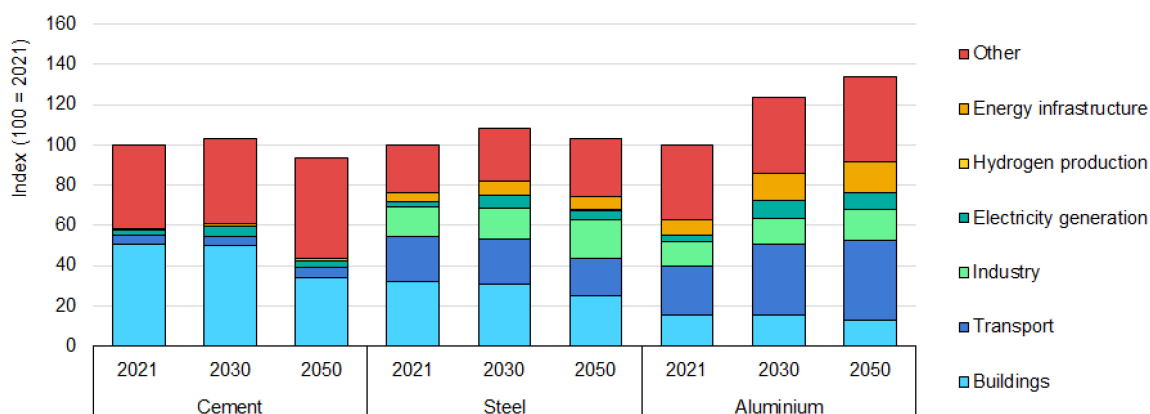

IEA. CC BY 4.0.

Notes: Energy infrastructure includes electricity grids, oil and gas pipelines, hydrogen transport, and CO₂ transport and storage. Industry includes material demand from industrial equipment but not from the plant shell. Transport includes vehicles and estimated material demand from road and rail infrastructure. Other includes non-energy infrastructure, consumer goods, packaging, textiles and miscellaneous uses.

Global demand for cement and steel is relatively flat as it is less driven by clean energy technologies and infrastructure, while demand for aluminium increases more substantially due to its role in electricity generation and distribution and low-emission vehicles.

Material efficiency

Using materials more efficiently plays a central role in curbing overall demand in the NZE Scenario. It directly reduces the need for emissions-intensive production in the near term and reduces the need to deploy costly near zero emission production technologies in the long term, thus avoiding the need to invest trillions of dollars in material production (see Chapter 6). It also helps alleviate the risk of supply shortages, particularly in the case of critical materials. Material efficiency encompasses a portfolio of measures at all stages of supply chains. Many of these strategies can already be adopted today, although innovation can help expand the overall potential. Some of these changes involve actions by businesses and other behavioural changes on the part of consumers (Box 3.2).

Design, manufacturing and material substitution

Better design of final products and reduced waste in manufacturing significantly reduce use of materials along clean energy supply chains in the NZE Scenario. For example, improvements in design and manufacturing reduce steel demand by about 10% in 2050 in the NZE Scenario relative to a baseline with limited material efficiency.

The opportunities for efficiency in design and manufacturing are diverse. Lightweight car designs reduce material needed for both car bodies and powertrains, while buildings system optimisation reduces material needs in construction. In mining and manufacturing, adoption of best practices, upskilling of workers and innovative techniques can reduce material wastage. For example, improving sorting of mining waste can limit the amount of useful minerals that end up in tailings dams, additive manufacturing can reduce scrap generation in vehicle manufacturing, best practices on construction sites can optimise the amount of cement used in concrete, and new techniques such as ultrasonic coating could reduce the use of some critical materials in electrolyzers by up to half (Sono-tek, 2022).

Material substitution also plays an important role. This can involve substituting lower-emission materials, lighter materials or alternative materials to lower the dependence on critical minerals that are vulnerable to disruptions or are in short supply (see Chapter 6). Examples include alternative chemistries for making EV batteries, switching to different electrolyser designs, and using innovative superconducting magnets that don't rely on rare earth elements (REEs) for wind turbines and EV motors.

Reuse and lifetime extensions

Reusing final products and extending their lifetimes also majorly reduces material requirements in the NZE Scenario. For example, longer building lifetimes reduce cement demand by 13% in 2050 in the NZE Scenario relative to a baseline with limited material efficiency.

Potential for longer lifetimes can be maximised by considering durability and reusability when designing products. For example, heat pumps can be designed with inverters to reduce cycling of motors and increase system lifetime, while buildings can be built to last longer through factoring modularity and repurposeability into the design. Encouraging reparability and better maintenance of equipment, vehicles and appliances can also extend lifetimes. This can be aided by predictive maintenance using novel digital technologies that remotely monitor, detect and pre-emptively address potential problems – including sensors, digital twins and machine learning. Partial component replacement is another option. For example, Ballard, a Canadian power systems company, is offering refurbishment of their fuel cells to replace the membrane while retaining the longer-lived existing hardware and plates, extending the useful service of their systems (Ballard, 2018).

Lifetimes can also be extended through repurposing. Repurposing EV batteries for secondary use in stationary energy storage could help reduce demand for critical materials. Repurposing existing oil and gas pipelines to transport CO₂ or hydrogen can reduce material needs and lowers costs (see Chapter 5).

Reusing or extending the lifetimes of products should generally be pursued only in instances where it leads to overall life-cycle emissions reductions. In cases where it would slow the roll-out of substantially lower-emission technologies, recycling may be a better option. For example, recycling the materials from internal combustion engine vehicles may be preferable to extending lifetimes, in order to not slow the roll-out of zero emissions vehicles.

Box 3.2 Behavioural change to reduce the supply chain challenge

Changes in consumer behaviour that result in lower demand for energy products and services is an important lever in reducing the scale of the clean energy and technology supply chains required to get to net zero. The scope of such changes and the potential for cutting energy needs are both considerable. For example, switching to public transport cuts the need for fuel to run cars and to make the materials needed to make the car itself. Consumer behaviour is affected by many factors, including price, social norms and fashions, and public awareness campaigns.

EVs are an example of how materials demand can be cut through behavioural change. Minimising the size of the EV battery, which depends on driving patterns and reducing range anxiety, would greatly reduce demand for critical materials. Maintaining rather than increasing the current average range of electric cars would enable batteries to be 20-25% smaller than in the NZE Scenario in 2030 and 2050, resulting in a 20% reduction in critical material needs for making EV batteries (IEA, 2022a). Encouraging more efficient utilisation of each EV (e.g. through car or ride sharing) could also help alleviate strains on material supply in the near term while achieving the same (or larger) emissions reductions.

The current energy crisis has prompted several public initiatives to conserve energy, particularly in Europe, showcasing the scale of the effort that can be mobilised in the right political and economic conditions. The European Commission has set out a range of demand-side measures to save energy in the REPowerEU package (see Chapter 1), which could save around 13 bcm per year of gas imports through behavioural changes (European Commission, 2022a). Recent related work includes the IEA's 10-Point Plan to Reduce the European Union's Reliance on Russian Natural Gas and 10-Point Plan to Cut Oil Use, and the inclusion of a new chapter on demand, services and social aspects of mitigation in Working Group III's contribution to the Sixth Assessment Report of the Intergovernmental Panel on Climate Change (IPCC) (IEA, 2022b; IEA, 2022c; IPCC, 2022).

Recycling and secondary production

In the NZE Scenario, opportunities to increase recycling and secondary production are maximised, bringing several benefits. The need for mineral extraction is reduced, along with the environmental damage it involves. Production-phase emissions are reduced, since recycled production is generally considerably less energy- and emissions-intensive than primary production. For instance, recycled nickel requires only about 25% of the energy requirements of primary Class I nickel (Argonne Laboratory, 2022), while secondary aluminium production emits 96% less CO₂ than primary production (Eurometaux, 2022). Recycling can also reduce the vulnerability of supply chains to disruptions if recycling is carried out close to demand centres.

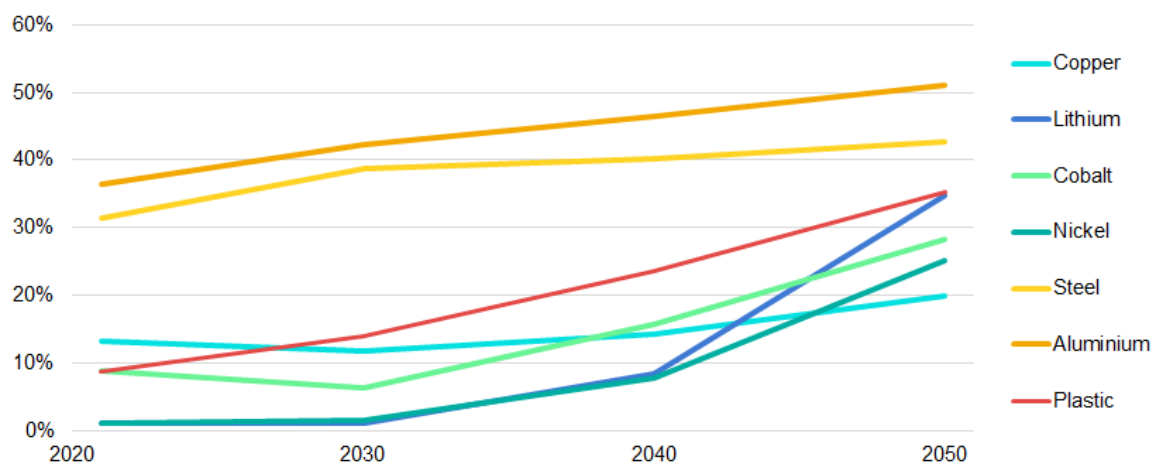
Figure 3.5 Share of secondary production in the global supply of selected materials in the NZE Scenario

IEA. CC BY 4.0.

Note: For steel, the share of scrap in total metal inputs is used, including internal and manufacturing scrap. For aluminium, internal scrap is excluded in line with the reporting convention of the industry. Values for nickel and cobalt do not include their eventual recycling as part of metal alloys such as stainless steel. For plastic, the combined production of all plastic types is used.

Sources: IEA analysis based on USGS (2022); IEA (2021); Aluminium Association (2021).

The share of secondary production increases strongly in the NZE Scenario, particularly for critical materials after 2030 as the first wave of clean energy technologies reaches the end of their life.

For bulk metals such as steel and aluminium, increasing recycling and secondary production involves improving collection rates, implementing advanced sorting technologies and expanding the capacity of well-established secondary production routes such as electric arc furnaces for steel. The potential for increased recycling rates is relatively modest for steel and aluminium since recycling routes are already well-established and end-of-life collection rates are already high (about 85% for steel and 70% for aluminium), as there is a strong economic incentive – secondary production tends to be less costly than primary. Increased secondary production for steel and aluminium in the NZE Scenario comes largely from increased scrap availability as products reach end of life, rather than due to drastically higher collection rates.

For other bulk materials, the potential for improvement is much greater. Less than 20% of plastic waste is collected for recycling today and less than 10% of total plastic production uses recycled material as an input. Innovative chemical and feedstock recycling methods are being developed to overcome the limited yield rate achievable with current mechanical recycling techniques and expand the range of plastics which can be easily recycled. In the NZE Scenario, collection rates reach over 50% by 2050 thanks to technology development, behavioural change and infrastructure expansion driven by policy interventions. For cement,

recycling is overall much more complicated, but innovation is under way to recover portions of cement, such as through concrete fines recycling.

For the critical materials that are widely used today, such as copper and nickel, recycling processes are already well established. For example, copper from wires, electronics and larger products is relatively easy to separate out for recycling. For some precious metals, the collection rates for recycling are high, such as gold at 86% and nickel at 60%, while there is still considerable potential to increase the rate for other metals, such as copper at 46% and cobalt at 32% (IEA, 2021). By contrast, recycling rates are very low for those critical materials that have only recently begun to be used widely and that have low concentration in final products. For example, lithium and REEs have recycling rates below 1%, as the recycling sector has had little time to develop recycling processes and infrastructure, and their low concentration makes recovery more expensive.

The secondary production of critical minerals as a share of total supply remains lower than for steel and aluminium throughout the projection period of the NZE Scenario. The rapid growth in demand for critical materials is very recent compared with the lifetimes of products they are used in. As a result, the share of secondary production increases significantly only after 2030, as the critical materials used to produce vehicles, equipment and appliances in the 2020s become available for recycling. For example, secondary production of lithium grows from negligible amounts today to almost 35% of global supply in 2050 (Figure 3.5).

Box 3.3 Increasing recyclability of clean energy technologies

Improving recyclability is a key part of improving the sustainability of clean energy technology supply chains. Innovation will be important here, both to design technologies to be more recyclable and to improve the efficiency of recycling methods. The hurdles vary by technology – here we take a closer look at EV batteries and wind turbine blades as illustrative examples.

EV batteries

EV batteries are difficult to recycle due to their complex composition. The simplest method to recycle them is through pyrometallurgy, where the whole battery is smelted to separate its metals; however, this process is not adapted to recover lithium, and the metals recovered need additional energy to be remanufactured into battery components. An alternative method is direct recycling, known as cathode healing, where battery components are physically unpackaged, separated and recycled or reused. This allows recovery of entire components, though doing so

cost-effectively on a large scale would require large volumes of well-designed batteries (Sloop, et al., 2020; Harper, et al., 2019).

A big expansion of recycling capacity – driven largely by increasing volumes of batteries reaching the end of their life – slows the rate of growth in critical mineral mining needed for making EV batteries after 2030 in the NZE Scenario. For example, increasing recycling rates of lithium enables mining capacity to be expanded eightfold from 2021 to 2050, rather than 13-fold were recycling rates to remain constant, reducing required investment in lithium mining by USD 12 billion. Recycling and reuse of EV batteries contributes most to cutting the need for lithium mining and processing, with grid batteries and other batteries from outside of clean energy technologies contributing to less than 10% of the total recycled or reused lithium in 2050 in that scenario.

Wind turbine blades

Wind turbines are another technology where further development is needed to expand recycling. While most parts of a wind turbine can be recycled, wind turbine blades can be difficult because of the composite materials used in their construction. Wind power is expected to produce approximately 5% of total composite waste worldwide in 2025, with that number likely to grow significantly in the future as more turbines are decommissioned (WindEurope, 2020). Current technologies for composite recycling generally use large amounts of energy and can be costly, but new techniques for recycling are under development, including solvolysis and pyrolysis (Goldwind, 2022). Designing blades to enhance recyclability without sacrificing performance can play a role in reducing end-of-life waste, while emerging additive manufacturing techniques could reduce waste from the manufacturing stage (Siemens Gamesa, 2022).

Mineral extraction

Some of the markets for the minerals that are needed in large quantities to produce materials needed for clean energy technologies are already mature. For example, iron ore for making steel, and bauxite for making aluminium and copper ores have been mined extensively for a very long time. The extraction of others, notably critical minerals such as lithium and cobalt, is relatively small today. Demand for all of the main critical minerals grows massively in the coming decade as demand from clean energy technologies expands in the NZE Scenario (Figure 3.6). By contrast, the transformation of the energy sector has little impact on total demand for iron ore and bauxite, given that material efficiency improvements largely outweigh the modest increase in material demand from

clean energy technologies (see section on material demand above) and increasing availability of scrap leads to reductions in the need for primary production and thus mineral ores.

Figure 3.6 Change in global demand for selected minerals in the NZE Scenario, 2021-2030

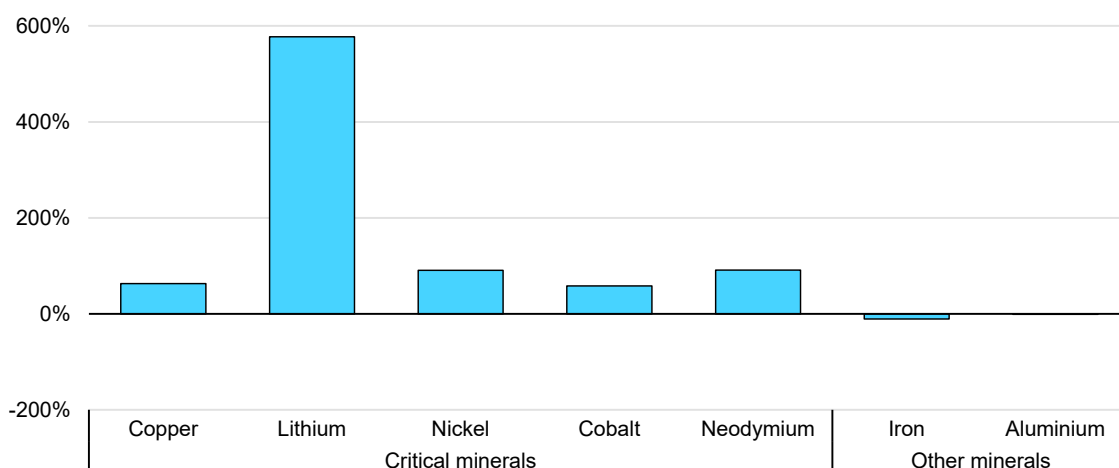

IEA. CC BY 4.0.

Note: Based on the mass of the mineral in the ore.

Demand for critical minerals grows very rapidly in the NZE Scenario, while demand for minerals to produce bulk metals declines marginally, albeit from a much higher starting point.

Expansion plans and gap with the net zero trajectory

Recent increases in climate policy ambition and specific government measures to accelerate the energy transition around the world are driving up expectations of increased global demand for critical minerals and stimulating investments in the mining sector. A number of new projects have been announced recently, though many of these projects will only increase supply several years ahead due to the long lead times (see Chapter 1).

The clean energy expansion in the NZE Scenario requires the extraction of critical minerals to increase rapidly, at rates that are much higher than in the past. Mine expansion needs are particularly high in the current decade. For example, the rate of growth in output of copper and lithium needs to double over 2021-2030 compared with the previous decade. Expansion requirements are more modest over 2030-2050, since the electricity and road transport sectors – the main sources of critical mineral demand – have already largely switched to clean technologies in the 2030s in the NZE Scenario. In contrast to critical minerals, mining of iron ore and bauxite falls over the current decade, thanks mainly to increased availability of scrap that enables increased secondary production and material efficiency that substantially curbs growth in total demand.

To meet rising demand for critical minerals in the NZE Scenario, both extraction from known resources and extensive exploration are needed to increase resource availability. The mining industry has already started responding to policy and market signals pointing to a rapid increase in demand for critical minerals by stepping up investment in new capacity. As a result, mining capacity for all five key minerals, taking account of already-announced expansion projects, is projected to be significantly higher in 2030 than today. However, this anticipated increase in capacity still falls short of that required to meet the projected levels of demand in that year in the NZE Scenario for all minerals (Figure 3.7).

The size of the gap between the primary production that is anticipated²⁰ to result from currently anticipated investments in expanding capacity and that projected in the NZE Scenario in 2030 varies across the leading critical minerals. The biggest gap is in lithium supply, amounting to 35% of what is needed to be on track with that scenario. This means that much more investment would be needed in the next three years in lithium mining to meet the NZE Scenario demand by 2030. Exploration drill counts suggest that this upturn may be forthcoming: four times more drilling was carried out in 2022 than the previous year, though how quickly the results lead to new capacity is very uncertain (S&P Global, 2022a).

The number of projects and resulting anticipated capacity for nickel mining have grown rapidly over the past year, in large part due to a focus by the Indonesian government on this sector. This country has about a fifth of the known global nickel reserves and is attracting international investment from both mining companies and battery companies such as LG, which has invested in a USD 300 million Indonesian mine project (Christina & Suroyo, 2022). Indonesia might be able to ramp up output rapidly, without the risks and long lead time associated with exploration, especially as permitting and administrative procedures have been accelerated. The shorter lead times in this country are already helping encourage development of nickel mining operations, with output nearly doubling between 2020 and 2022 (S&P Global, 2022b). This suggests that it may be possible to fill the global nickel supply gap by 2030.

For cobalt, the supply gap is one of the lowest of all critical minerals at 10%, thanks to innovations in battery chemistry over the last five years that have reduced the cobalt content of batteries. This is a good example of how innovation can help reduce mineral demand in the face of rising costs and concerns about environmental, social and governance considerations.

²⁰ Anticipated supply refers to expected future production based on expert judgement from third party data providers. Expectations in commodity prices can have a large impact on the expected supply – a higher price might lead to more supply coming online. At the same time, unexpected delays in financing, permitting, or construction could delay projects, yielding a lower supply. The value is therefore lower than a sum of all announced projects.

Figure 3.7 Primary production of selected minerals by country/region in the NZE Scenario and based on currently anticipated supply

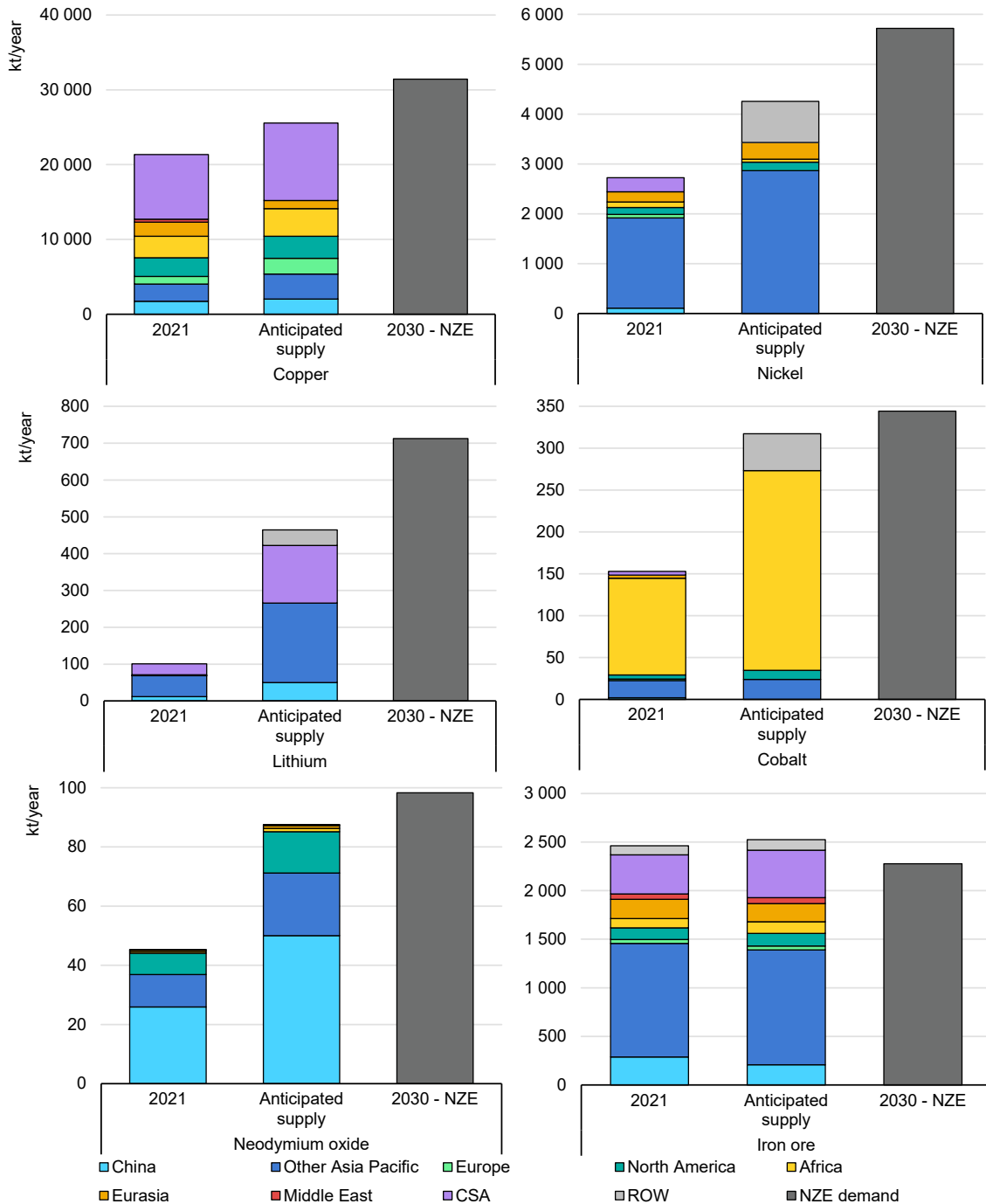

IEA. CC BY 4.0.

Notes: NZE = Net Zero Emissions by 2050 Scenario; ROW = rest of the world; CSA = Central and South America. Other Asia Pacific excludes China. Anticipated supply includes existing production. Anticipated supply relates to 2026 for copper and iron ore and to 2030 for lithium, cobalt, nickel and neodymium (see note 3). For neodymium, the share of producing regions is assumed to be proportional to REE production and is constant over time due to a lack of precise data. Minerals are shown in terms of their mass in the ore, except for iron ore.

Sources: IEA analysis based on USGS (2022); S&P Global (2022c); S&P Global (2022d); S&P Global (2022e); European Commission (2020); Eurometaux (2022).

Anticipated supply falls short of that required to meet projected demand in 2030 in the NZE Scenario for all minerals except iron.

Scaling up mining capacity for closing the gap to NZE Scenario comes with an investment risk, as it relies on the scale-up of clean energy technologies further down the value chain, including in areas such as PV and batteries in particular. The outlook appears bright there given that these are areas of clean energy with record installations today, and manufacturing capacity is rapidly expanding (see Chapter 4). However, just how large the gap might be by 2030 remains uncertain: for example, demand levels in line with current government ambitions, as depicted in the APS, are 10% to 40% lower than in the NZE Scenario for critical minerals. Therefore, in the APS there is a significantly smaller gap compared with anticipated investments than the equivalent gap in the NZE Scenario: nickel and copper are the only two commodities for which there is a gap between APS demand levels and anticipated supply, at 10% for nickel and 5% for copper. Private-sector plans for production capacity expansion at a global level seem therefore to be well aligned with current government plans, but current plans are not sufficient to limit global warming to 1.5°C.

The extraction of minerals needed for clean energy technologies and infrastructure can be increased by either developing greenfield mining projects or expanding output at existing mines. Opening a new mine takes a long time from discovery to production, on average 17 years (see Chapter 1). This process requires engineering works, including installing infrastructure, stripping overburden (rock and soil overlying the mineral-bearing seams) in the case of surface mines or digging shafts and tunnels in the case of underground mines, and designing and installing mining equipment, as well as administrative procedures related to environmental assessments, permitting, and negotiation with local communities. Once reserves have been proven and the decision to invest has been taken, a new mine can in principle be built in under five years, depending on project specifications and in the absence of legal complications. Due to the heavy investments required and the long-term nature of such projects, confidence in persistent demand is required to encourage investment in mining.

Expanding the production capacity of existing mines generally takes much less time, because much of the infrastructure and equipment is already in place and administrative procedures are more straightforward and less at risk of being stalled by public opposition. But the scope for expanding output at existing mines in most cases is relatively limited, so that most of the increase in output needed over the period to 2030 would have to come from new mining projects. For lithium and nickel, over 70 new average-sized mines²¹ are required to reach the output volume needed to meet the needs of the NZE Scenario in that year. For cobalt, 30 mines are needed and, for copper, a staggering 80 new mines would be required – a huge task.

These capacity additions are feasible, but time is short. Investment would need to flow into new projects within the next three years to bring the project pipeline up to speed with the NZE Scenario trajectory by 2030, assuming no major delays in permitting and construction. We estimate that total investment of around

²¹ The quadratic average of the size of all existing mines for a given mineral is used here.

USD 360 billion to USD 450 billion (in real 2021 dollars)²² would be needed cumulatively over 2022-2030 in critical mineral mining to reach the projected level of production in that scenario. Two-thirds of the total is for copper mining and most of the rest is for nickel. Cobalt requires relatively little extra investment as it is often a co-product of nickel and copper operations. The cumulative investment required to bring online the anticipated supply is around USD 180 billion to USD 220 billion, implying a shortfall of USD 180 billion to USD 230 billion worth of additional projects to meet the needs of the NZE Scenario (Figure 3.8). Most currently anticipated investments are in Africa, Central and South America, and Asia Pacific. Additional investments would have to start flowing at the latest by 2025 to allow time for construction and commissioning by 2030.

Figure 3.8 Anticipated investment in mining of critical minerals by region/country and that required to meet mineral demand over 2022-2030 in the NZE Scenario

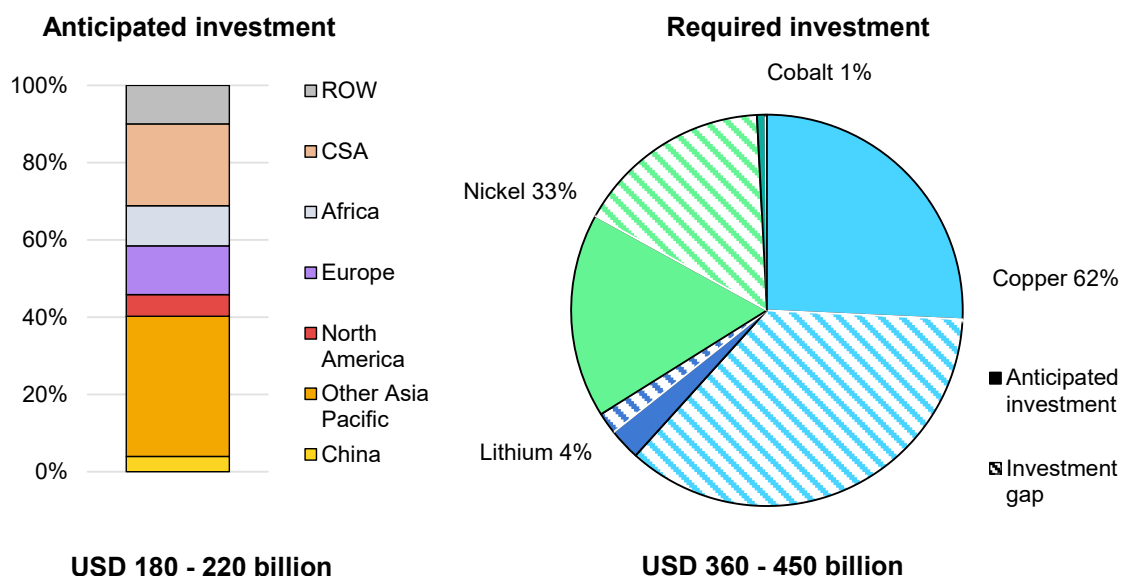

IEA. All rights reserved

Notes: CSA = Central and South America; ROW = rest of the world. Other Asia Pacific excludes China. Anticipated investments cover four critical minerals (lithium, nickel, copper and cobalt) (see note 3). Neodymium not included because of a lack of data. Cobalt production being mainly a co-product of copper and nickel, the additional capital investment needed to open a copper-cobalt mine compared with a pure copper mine is considered. A range is quoted for anticipated and required investments, considering the range of available cost estimates for diverse feasibility studies of mining projects.

Sources: IEA analysis based on company feasibility studies; Bartholomeusz (2022); S&P Capital (2022); USGS (2022); S&P Global (2022c); S&P Global (2022d); S&P Global (2022e); European Commission (2020); Eurometaux (2022); Jervois (2020).

Around a third of anticipated mining investments are concentrated in Africa and Central and South America, but additional investments are required to meet the needs of the NZE Scenario.

²² Investment requirements for mining activities are highly uncertain as they vary considerably according to ore grade, mine type and deposit composition. For these reasons the reported investment values are provided as a range.

While demand for critical minerals in 2040 in the NZE Scenario is larger than in 2030, the rate of increase slows significantly after 2030 as clean energy technologies saturate the market and recycling grows. This would make it easier to mobilise sufficient investment in mineral extraction to meet the needs of the NZE Scenario. Nonetheless, exploration activities and the firming up of resources into proven reserves would still need to accelerate, in parallel with capacity expansions at existing mines, to avoid bottlenecks further into the future.

A major driver for investment in mining exploration and operation is the expected price of commodities. Higher prices would make projects more profitable and expand potential supply by increasing the number of resources that can be extracted profitably. In the NZE Scenario, the very rapid scale-up of demand is likely to be so fast that commodity prices might remain at levels close to recent historical peaks up to 2040, helping to stimulate investment (Boer, Pescatori & Stuermer, 2021).

For both critical and bulk materials, increased secondary production using recycled inputs reduces demand for raw minerals and, therefore, the need for new mines in the NZE Scenario. In the case of iron ore, there is no investment gap to 2030. This hinges on developing additional recycling infrastructure, which should not be particularly hard given the maturity of such infrastructure.

Geographical distribution

Anticipated investments in the mining of critical minerals point to an overall modest improvement in the geographical diversity of production in the coming years. The production of most of the leading minerals is currently highly concentrated in a small number of countries and regions (see Chapter 2). The decline in concentration by 2030 implied by the anticipated supply varies by mineral. That of nickel production is poised to increase substantially, with the share held by Indonesia – the leading producer – due to increase by over 10 percentage points to almost half of world production once current projects are completed (Figure 3.9).

In the case of lithium mining, anticipated capacity additions would lead supply in 2030 to be only slightly more diverse than it is now, mostly thanks to the start-up of mining in Canada. Australia and Chile will still account for around 70% of all mining once all those additions are fully operational. Ongoing investments in the mining of cobalt, which has the highest concentration among the five critical minerals assessed, are not expected to significantly affect the geographic distribution, with the Democratic Republic of Congo remaining far and away the dominant producer.

Copper, iron ore and bauxite extraction is much more diverse today than for the other metals, and is due to remain diverse once currently anticipated investments

are completed. Nonetheless, some key producing countries will continue to dominate global supply. Chile will still account for around a quarter of world copper production when current projects are completed in 2026, while Australia will remain the leading iron ore producer with 38% of global market share.

Figure 3.9 Shares of the leading regions in global mining of selected critical minerals in 2021 and 2030 based on currently anticipated investments

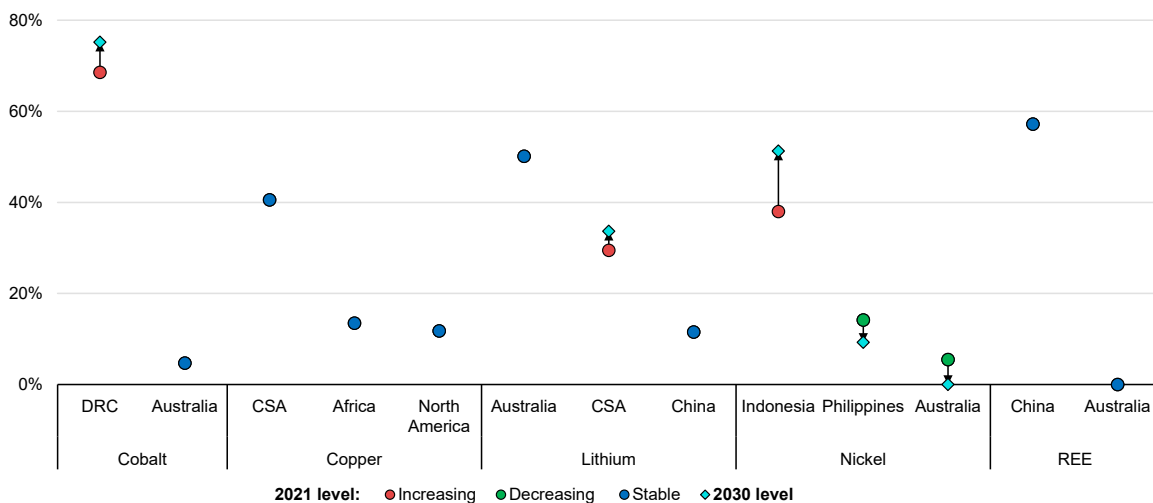

IEA. CC BY 4.0.

Notes: DRC = Democratic Republic of Congo; CSA = Central and South America. Stable is defined as a change of less than 4%. Dots represent 2021 value and the arrow the change to 2030.

Sources: IEA analysis based on USGS (2022); S&P Global (2022c); S&P Global (2022d); S&P Global (2022e); European Commission (2020); Eurometaux (2022).

Anticipated investments in mining of critical minerals point to an overall modest improvement in the geographical diversity of production in the coming years, except for nickel.

Regional policy and market developments

Policies being adopted in various countries may help with the scale-up of mineral extraction and/or the reduction in raw mineral needs through recycling, particularly for critical minerals. According to the IEA’s Critical Minerals Policy Tracker, released in November 2022, nearly 200 such policies and regulations are now in place around the world, of which over 100 new ones have been enacted in the past two years alone, with a growing attention to the adoption and implementation of sustainable and responsible practices in critical mineral supply chains (IEA, 2022d).

In the **United States**, as part of the Infrastructure Investment and Jobs Act signed in 2021, the Department of Energy is implementing a USD 6 billion grant programme including USD 3 billion for battery manufacturing and recycling. This includes financing demonstration projects and commercial-scale facilities for battery recycling (BGR Group, 2022). Some major projects funded through this

grant have already been announced: Lilac Solutions is investing in lithium production from low concentration brine, and Cirba Solutions is developing a facility to recycle lithium-ion (Li-ion) batteries (White House, 2022; US DOE, 2022).

In addition, the Inflation Reduction Act (IRA), signed in 2022, requires the use of critical minerals that are extracted, processed or recycled in the United States or come from countries with which the United States has free trade agreements, for EVs to qualify for federal tax credits (Loan Programs Office, 2022). This is expected to incentivise investments in mining operations within the 20 countries the United States has free trade agreements with, including Chile and Australia. In addition, the Defense Production Act of 1950, which gives the president authority to mobilise industry for national defence reasons, was invoked over critical minerals and batteries supply in 2022. This gives the government the possibility of strengthening the US domestic industrial base for large-capacity batteries and their component minerals, using loans and purchase commitments to incentivise companies to expand domestic mining (Biden, 2022).

Australia is aiming to encourage expansion of its critical mineral extraction capacity, notably cobalt, vanadium and REEs (Australia, Department of Industry, Science, Energy and Resources 2022). The country is already the world's largest supplier of iron ore, bauxite and lithium. To support this goal, the government plans to introduce measures to de-risk new mining projects, create an enabling environment and strengthen international partnerships by offering financial support to projects at diverse levels of development, including enabling infrastructure and research, development and demonstration. In 2021, the Australian government established the AUD 2 billion (Australian dollars) Critical Minerals Facility to support critical mineral projects with loans, loan guarantees, bonds and working capital support as a complement to commercial financing (Australian Government, 2021).

The **European Union** is currently highly dependent on imports of critical minerals. For instance, EU countries supply 4% of copper ore but represent 12% of refined copper demand (WBMS, 2022). Free trade agreements have been negotiated with mineral exporters, such as with Korea in 2015 (which produces 20% of the world's indium²³), and the association agreement with Chile, a large lithium producer, is being modernised (EPRS, 2021). Demand for locally sourced raw minerals is encouraging new lithium mining projects in Europe, including one led by Vulcan in Germany in geothermal brines (Vulcan, 2022), a Baroso lithium mine project in Portugal (Savannah, 2019) and the Echassières mine from Imerys in France (Vif, 2022). Investments are also being made in research programmes such as RawMatCop, which relies on earth observation data from the Copernicus satellite

²³ Indium has diverse applications in semiconductors, solar PV and the control rods of nuclear power reactors.

system to assist in exploration or monitoring of mining sites, and the EIT RawMaterials programme supports start-ups and innovative projects around raw materials (Kasmaeeyazdi, et al., 2021; EIT, 2022).

Some oil and gas companies and institutions are also investing in critical mineral supply. In **Argentina**, the national oil company, YPF, has started lithium exploration (Bianchi & Morland, 2022).

CO₂ emissions

Extracting minerals is a highly energy-intensive process. Most of the energy currently used in mining operations is of fossil origin (either direct use of fossil fuels or electricity generated using them) and so mineral extraction activities result in significant CO₂ emissions. For example, in Australia, the mining and quarrying sector meets between 60% and 70% of its energy needs with fossil fuels, the rest being mainly electricity. This energy is required to power the various machinery used for digging and extracting earth and rocks, as well as on-site trucks, ventilation, crushing and separating the ore. In addition to CO₂ and other greenhouse gas emissions, mining also has considerable impacts on ecosystems, air, water and local populations (see Chapter 2).

The energy intensity of mining varies considerably by mineral type, the quality of the ore (primarily the concentration of the ore in the mined rock) and the nature of the mining process involved. For instance, the average ore grade of mined nickel is 30 times lower than that of bauxite, which largely explains why the energy intensity of nickel mining is 30 times higher than bauxite (Figure 3.10). Different mining processes can also result in very different energy intensities for the same mineral. Carbon intensities also vary according to the type of energy used.

An expected deterioration in the quality of ore (as measured by ore concentration) may increase the energy intensity of mining operations. Due to a combination of higher demand, international market prices and better technologies, lower concentration reserves have become more economically viable than in the past, pushing the global average ore grade down. Copper ore grade could decline by between 1.5% and 3.7% per year of the next decades (Northey et al., 2014; Cochilco, 2021), and nickel by around 1.2% per year on average (Olafsdottir & Sverdrup, 2021). This rate of ore quality decline could lead to a 25-30% increase in energy intensity of mining operations by 2050 for these minerals. Bulk mineral ore grade is also decreasing. For example, average iron ore grade has dropped from above 55% in 1980s to around 45% at present (Mudd, 2013). Large deposits, such as the sedimentary metamorphic type in the People's Republic of China (hereafter, "China"), have ore grades below 35% (Li et al., 2014). Were the average ore grade to drop to such a level by 2050, iron ore mining energy intensity would rise by about 25%, all other things being equal.

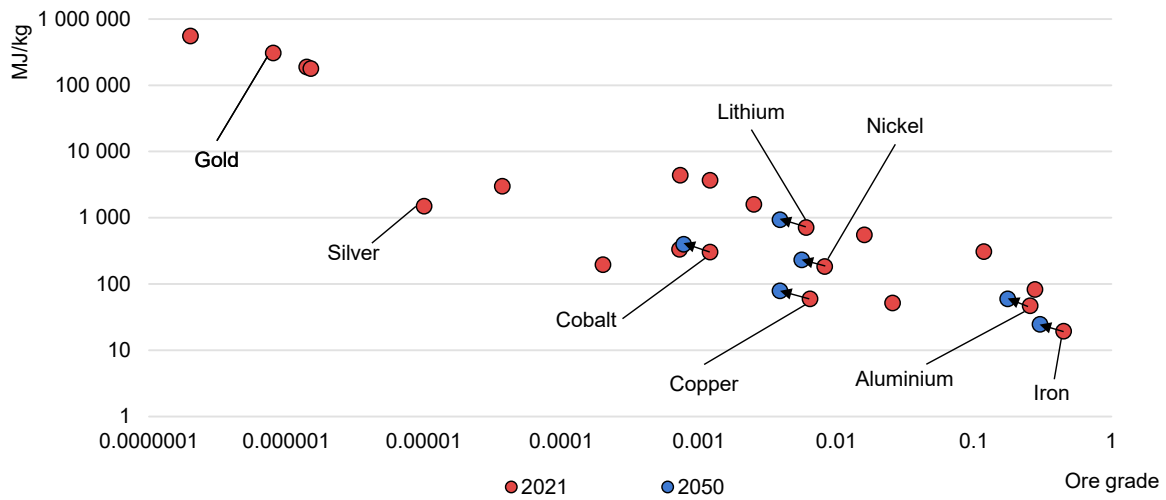
Figure 3.10 Global energy intensity and average grade of ore production for selected metals

IEA. CC BY 4.0.

Notes: Logarithmic scale. Energy intensity is based on the primary production of metals, including mining and processing. Metals presented in this figure are, in decreasing ore grade order: iron, chromium, aluminium, magnesium, zinc, titanium, nickel, copper, lithium, zirconium, vanadium, cobalt, tantalum, tin, molybdenum, gallium, silver, palladium, platinum, gold and rhodium. Lithium ore grade values are for hard rock deposits and not brine. Potential energy efficiency improvements are excluded.

Sources: IEA analysis based on Argonne Laboratory (2022); UNEP (2013); Nassar et al. (2022).

Ore quality is set to fall as the best resources are depleted at existing mines and higher prices and better technologies make lower-quality ores more economic at new mines.

Assuming energy intensities (the amount of energy needed to extract a tonne of mineral) evolve in line with the degrading ore grade, total global energy use in mining critical minerals would double between 2021 and 2030 to meet the rising demand levels depicted in the NZE Scenario (Figure 3.11). Copper would remain the largest contributor to energy needs for mining of critical minerals (larger than iron ore and bauxite combined), accounting for around 70% of their total energy use in 2030. Cobalt, despite being more energy-intensive to extract than copper, would still make up 2% of total energy use for critical mineral mining due to the far smaller volumes extracted. The increases from critical minerals would more than offset small declines in energy use in mining bulk minerals. In particular, energy use for mining iron ore would drop by around 5%, as a result of stagnant steel demand and increased recycling, while that used to extract bauxite would increase slightly.

Figure 3.11 Theoretical global energy consumption and CO₂ emissions in mining of selected minerals for meeting NZE Scenario demand levels at current carbon intensity

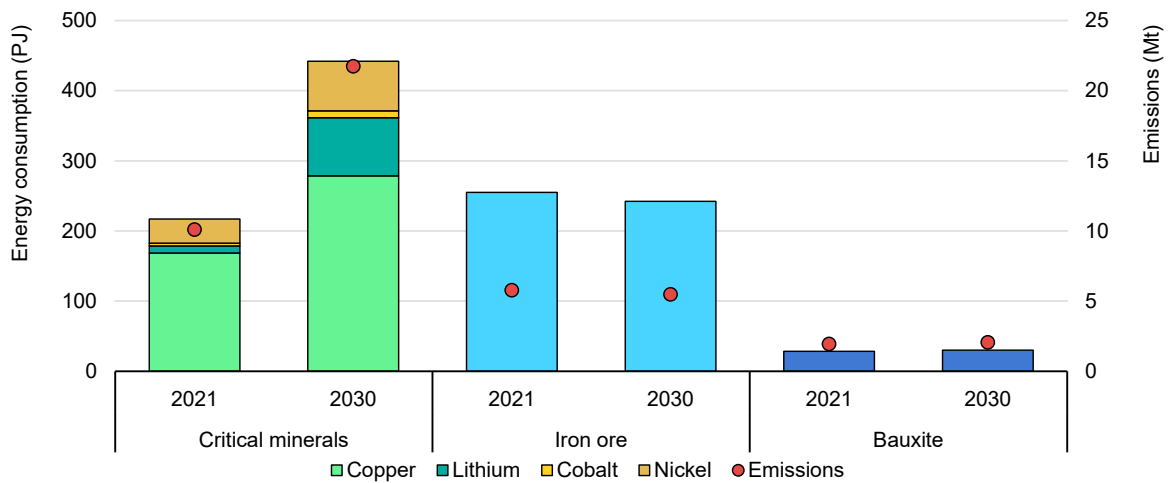

IEA. CC BY 4.0.

Notes: The energy and emissions intensities of mining are assumed to evolve following ore grade depletion and ignoring potential efficiency gains. For lithium, the weighted average of production from brine and spodumene is used. Neodymium not included because of a lack of data.

Sources: IEA analysis based on Argonne Laboratory (2022); IEA (2021); Warren Centre (2020).

At constant intensities, global energy use and emissions from mining critical minerals double between 2021 and 2030 with rising output in the NZE Scenario.

Assuming carbon intensities evolve in line with the degrading ore grade, global CO₂ emissions from mining critical minerals double over 2021-2030 in the NZE Scenario. The increase in emissions would be largest for lithium, at 700%, due to the big increase in output. Emissions from iron ore mining would fall by 5% and those from bauxite mines would increase slightly. As a result, total emissions from critical minerals would be five times greater than those from iron ore mining in 2030, compared with two times today. Nonetheless, total mining emissions would still be small compared with other industrial sectors, including critical mineral processing and bulk material production. Emissions from mining the six minerals considered here combined in 2030 would be equal to just 1% of those from steel production emissions today or 0.1% of global energy sector emissions. Overall emissions from mining of all types of minerals fall sharply in the NZE Scenario thanks to increased electrification, the deployment of innovative technologies and fuel switching.

Decarbonising mining operations

The principal way in which CO₂ emissions from mining operations can be reduced is by switching to decarbonised electricity as the primary form of energy. Drilling, digging, loading, hauling, crushing and separation, as well as mine ventilation, all require lots of energy. For most of these processes, electrification is already a

practical option. For example, the Borden gold mine in Canada became one of the first all-electric underground mining operations in 2019 (Mining Technology, 2020). In addition to emissions savings, using electrical equipment can bring other benefits, such as savings in cooling and ventilation from switching from internal combustion engines, which give off a lot of heat.

Electrifying mining trucks, which are an important source of on-site emissions as well as local air pollutants, is more difficult using current technologies. Those trucks are designed to carry very large payloads, so switching to EVs would mean they would need large batteries that would need to be recharged regularly, though this would be facilitated by their operation within confined areas with predictable, usually short, routes. A consortium led by Shell is designing a system allowing the electrification of trucks with a 220 tonne payload and charging points at loading and unloading points (Gleeson, 2022). Hydrogen or hydrogen-derived fuels could prove to be a viable alternative for powering mining trucks (Chen, 2022). Other electrification alternatives exist such as through catenary lines or the use of conveyor belts.

A major problem for mining operations is that they are often isolated from the electricity grid and so currently rely on fossil fuels to meet on-site energy needs. But the recent declines in the cost of renewables have made them more attractive as an alternative, distributed through microgrids, transformed on-site into hydrogen or paired with other energy storage options. Worldwide, mining companies invested in 3.4 GW of renewable energy capacity both on-site and off-site in 2019, up from 0.3 GW in 2015 (BNEF, 2020b). Nevertheless, the rate of deployment would need to increase at a much faster rate to decarbonise most mining operations before 2050. An example of the impact of clean electricity on mining emissions is the Swedish company Boliden, which is able to produce primary copper with a carbon footprint of less than 1.5 kg of CO₂ per kg of output, compared with an average of 4 kg of CO₂ for the industry (including all direct and indirect emissions) thanks to heavy reliance on hydroelectricity (Onstad & Harvey, 2021).

In the NZE Scenario, electrification and, to a lesser extent, recycling and efficiency gains eliminate almost all mining emissions by 2050, despite the impact of increased demand and falling ore quality (Figure 3.12). Innovation could even lead the sector to achieve net negative emissions, as the mining industry could store some CO₂ through the mineral carbonation of certain tailing waste. Companies such as Canada Nickel and De Beers are experimenting with this method (Canada Nickel, 2022; De Beers, 2022).

Figure 3.12 Decomposition of change in global direct CO₂ emissions from mining of selected minerals between 2021 and 2050 in the NZE Scenario

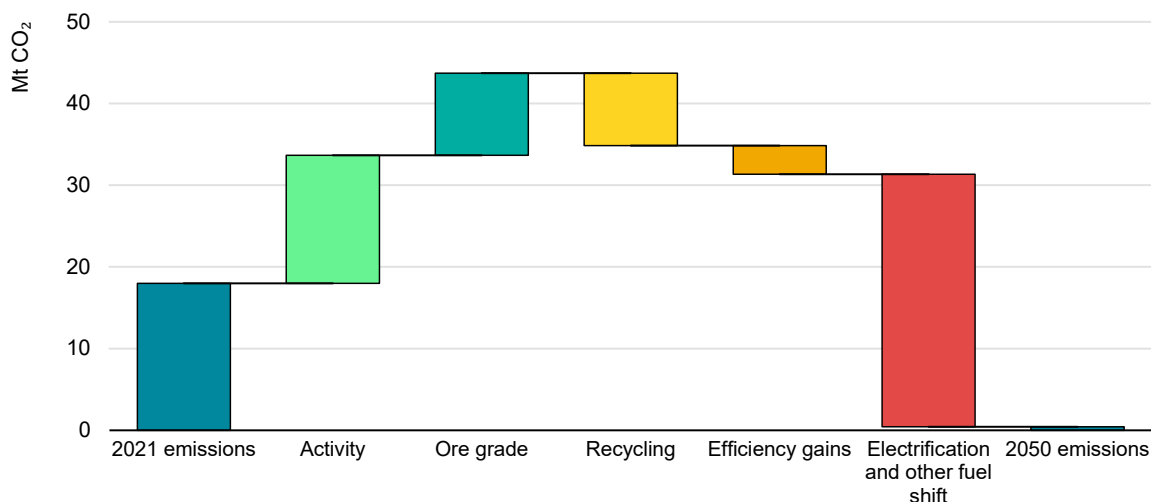

IEA. CC BY 4.0.

Notes: Emissions from mining of iron ore, bauxite, copper, cobalt, nickel and lithium are included. Other fuel shifts include hydrogen, bioenergy and other direct renewable energy use. Copper ore grade is assumed to fall from 0.60% to 0.39% in 2050, nickel from 0.81% to 0.56% and iron ore from 44% to 30%. Lithium and cobalt ore grades follow the same trends as that of copper while bauxite follows that of iron ore.

Sources: IEA analysis based on IEA (2021); Argonne Laboratory (2022); McKinsey (2020).

Electrification, as well as recycling and efficiency gains, eliminates almost all mining emissions by 2050 in the NZE Scenario, despite rising demand and falling ore quality.

Materials production

The production of critical and bulk materials is an important step within supply chains for clean energy technologies and infrastructure. Mineral ores need to undergo processing and refining before they are useful for clean energy technology manufacturing. For critical materials, the rapid build-out of processing facilities and decarbonisation of production processes is needed to meet demand in the NZE Scenario. Near zero emission production processes for bulk materials have the largest potential to reduce total emissions from material production, given the large volumes of production.

Critical materials production

Expansion plans and gaps with the net zero trajectory

For critical materials, mineral refining and processing capacity – referred to here as production capacity – does not necessarily follow mining capacity, as processing plants are not always linked to the output of a single mine. As a result, gaps can emerge between the supply of raw critical minerals and the capacity to refine them in the event of a mismatch between expansion projects, potentially leading to bottlenecks – especially as the lead times in building processing

facilities generally amount to several years (though they are shorter than for mining projects – see Chapter 1). Thus, to meet projected demand for all critical materials in the NZE Scenario in 2030, capacity would need to increase sufficiently in both mining and processing facilities. Furthermore, producing the specific chemicals required for technology manufacturing, for instance for cathodes used in Li-ion batteries, requires multiple refining steps to go from ore to concentrate to the final chemical, thus multiplying the potential bottlenecks.

Currently anticipated expansions of production capacity point to a significant gap emerging in the supply of some refined critical materials, notably nickel and lithium, regardless of whether mining capacity is sufficient. In the case of nickel sulfate, capacity additions would quadruple total capacity but would still cover only 40% of demand in the NZE Scenario by 2030 (Figure 3.13). By contrast, anticipated expansion in mining would satisfy 75% of demand. For lithium hydroxide and carbonate, the projected gap in production capacity in 2030 is around 35%, which is around that of mining. This implies that, unless new expansion projects in processing as well as mining are launched soon, the required expansion of EV fleets worldwide to remain on track for net zero by 2050 will be severely hindered. For cobalt sulfate, there is a looming 25% gap in production capacity, even though anticipated mining capacity is close to demand. For copper, the production capacity gap is only 15% (compared with 20% in mining).

In the past few years, polysilicon supply has been a bottleneck in solar PV supply chains, as it has grown less rapidly than that of cells, wafers and modules. The supply-demand balance was particularly tight in 2021. However, during 2022 many key large-scale manufacturers announced expansion plans to secure sufficient supply of polysilicon in the coming years. For example, Zhonghuan Semiconductors recently announced an investment of USD 3.3 billion in new polysilicon manufacturing capacity, Xinte Energy USD 2.8 billion and Hoshine Silicon USD 2.7 billion (Shaw & Hall, 2022a; Shaw & Hall, 2022b; Shaw, 2022).

In the APS, a scenario in line with current government ambitions, supply gaps for material processing do exist but at a smaller scale than in the NZE Scenario, since demand for critical minerals is lower. In 2030, about 5% of copper, 40% of nickel sulfate and 5% of neodymium oxide needs in the APS are not met by anticipated material supply. Meanwhile, anticipated supply could meet APS demand in 2030 for lithium chemicals, cobalt sulfate and polysilicon.

Figure 3.13 Production of selected critical materials by country/region in the NZE Scenario and based on currently anticipated supply

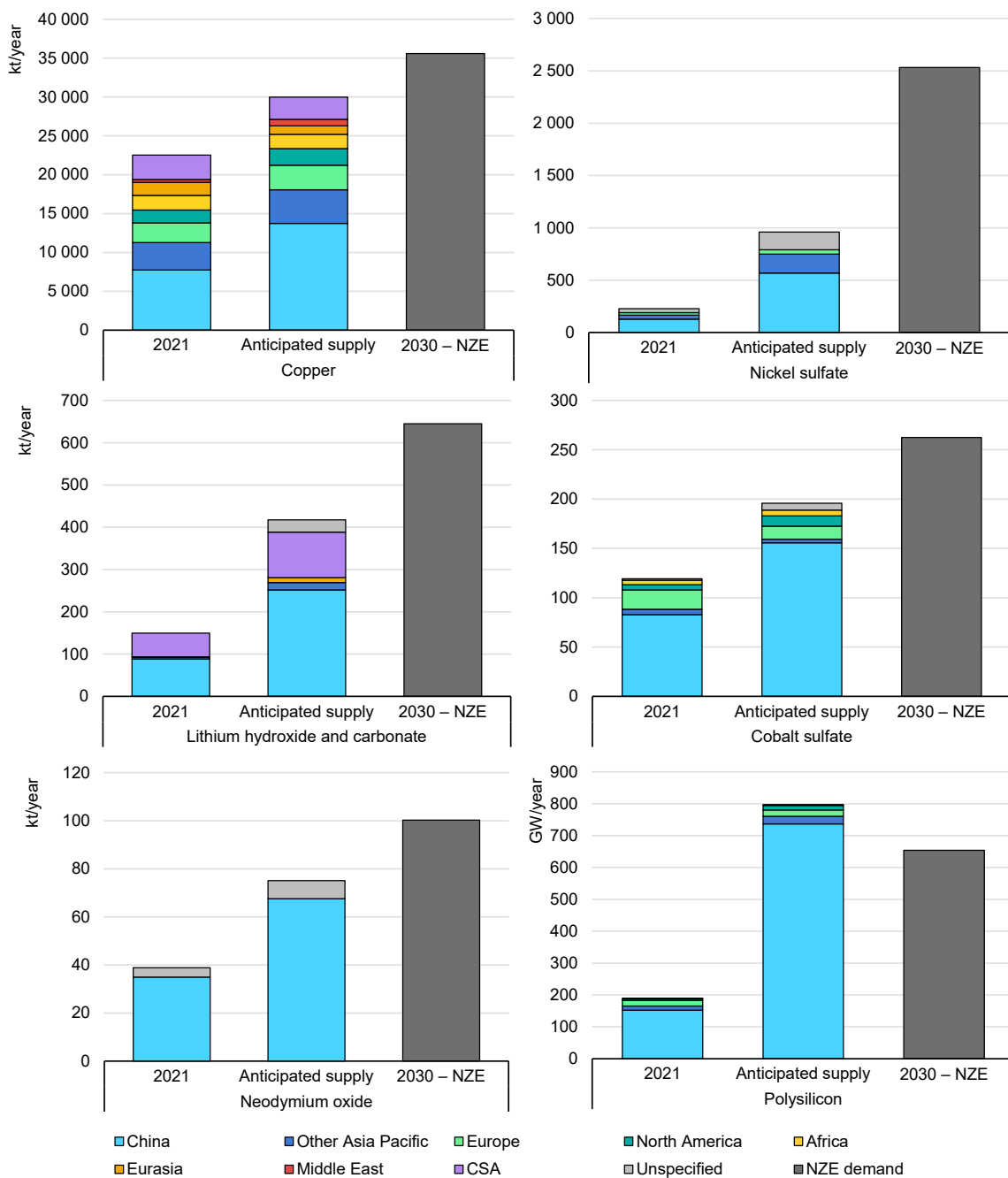

IEA. CC BY 4.0.

Notes: NZE = Net Zero Emissions by 2050 Scenario; CSA = Central and South America. Other Asia Pacific excludes China. Anticipated supply includes existing production. Anticipated supply refers to 2026 for copper and 2030 for cobalt sulfate, nickel sulfate, lithium, neodymium and polysilicon (see note 3). For neodymium, the share of producing regions is assumed to be proportional to rare earth production and constant over time. Accessed data for polysilicon production capacity was converted to production considering an 85% utilisation rate.

Sources: IEA analysis based on IEA (2021); USGS (2022); BNEF (2022); BNEF (2020a); S&P Global (2022d); S&P Global (2022e); European Commission (2020); Frasel et al. (2021); InfoLink (2022); Eurometaux (2022), Adamas Intelligence (2020).

Anticipated supply points to a gap in the supply of some critical materials relative to the NZE Scenario, notably nickel and lithium, regardless of whether mining capacity is sufficient.

In contrast to mining, nickel is the metal requiring the largest additional investments in production plants to satisfy increased demand in the NZE Scenario. Polysilicon is the only critical material for which anticipated supply is sufficient to satisfy projected demand. China is investing the most in new critical material production capacity, accounting for about 70% of global anticipated investments, followed by the rest of the Asia Pacific region and North America. In total, between USD 90 billion and USD 210 billion²⁴ would need to be invested cumulatively over 2022-2030 in installing critical mineral processing capacity to meet projected demand (Figure 3.14). Currently anticipated investments account for around two-thirds of that.

Figure 3.14 Anticipated investment in critical material production by region/country and that required to meet demand over 2022-2030 in the NZE Scenario

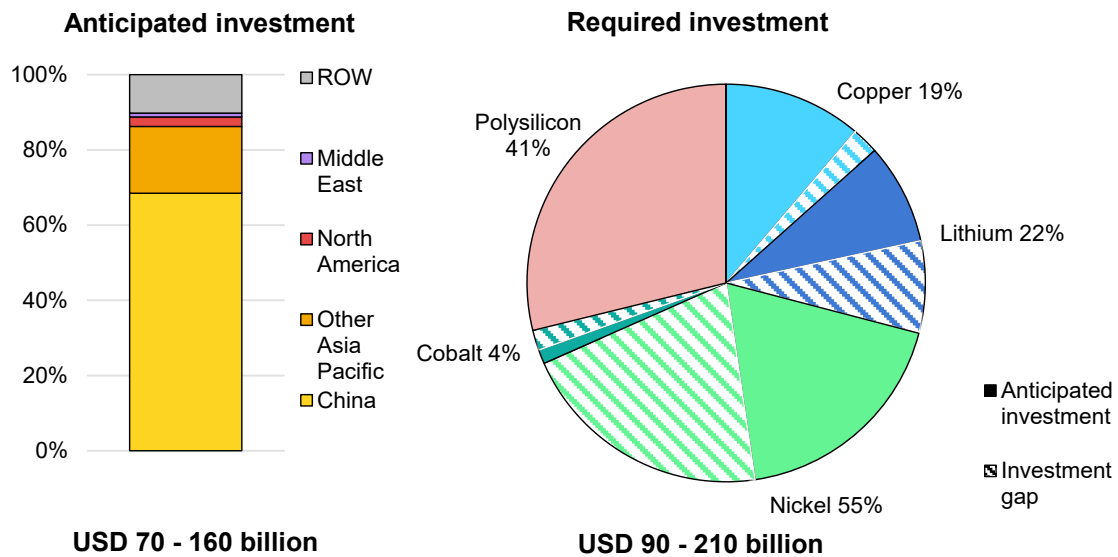

IEA. CC BY 4.0.

Notes: ROW = rest of the world. Other Asia Pacific excludes China. Anticipated investments cover lithium, nickel, copper, cobalt and polysilicon (see note 3). Neodymium is not included because of a lack of data. Cobalt production, being mainly a co-product of copper and nickel, it is assumed that the capital expenditure for cobalt is at the same level as nickel. A range is quoted for the anticipated and required investments, considering the range of available cost estimates for diverse feasibility studies of material production projects.

Sources: IEA analysis based on company feasibility studies; Bartholomeusz (2022); IEA (2021); USGS (2022); BNEF (2022); BNEF (2020a); S&P Global (2022d); S&P Global (2022e); European Commission (2020); Frasel et al. (2021); InfoLink (2022); Eurometaux (2022).

Anticipated investments in critical material production, concentrated in China, fall well short of that required in the NZE Scenario, especially in nickel processing.

²⁴ Investment requirements for critical material production activities are highly uncertain as they vary considerably according to factors such as the grade of the mineral ore being processed, the specific processing technology and the location. For these reasons the reported investment values are provided as a range.

Geographical distribution of production plants

Anticipated investments in the production capacity of most critical materials points to a continuation of the geographical concentration of supply in China in the coming years. The country is already the leading producer of all refined critical metals, and its share of global output is set to rise to 2030 (Figure 3.15). Processing of copper ores, of which almost 40% is mined in Chile and Peru, and cobalt, more than two-thirds of which comes from Democratic Republic of Congo, is set to become increasingly concentrated in China; its share of total refined output is rising from 35% to 45% for copper and remains above 70% for cobalt sulfate.

Figure 3.15 Shares of the leading regions in global processing of selected critical minerals in 2021 and 2030 based on currently anticipated investments

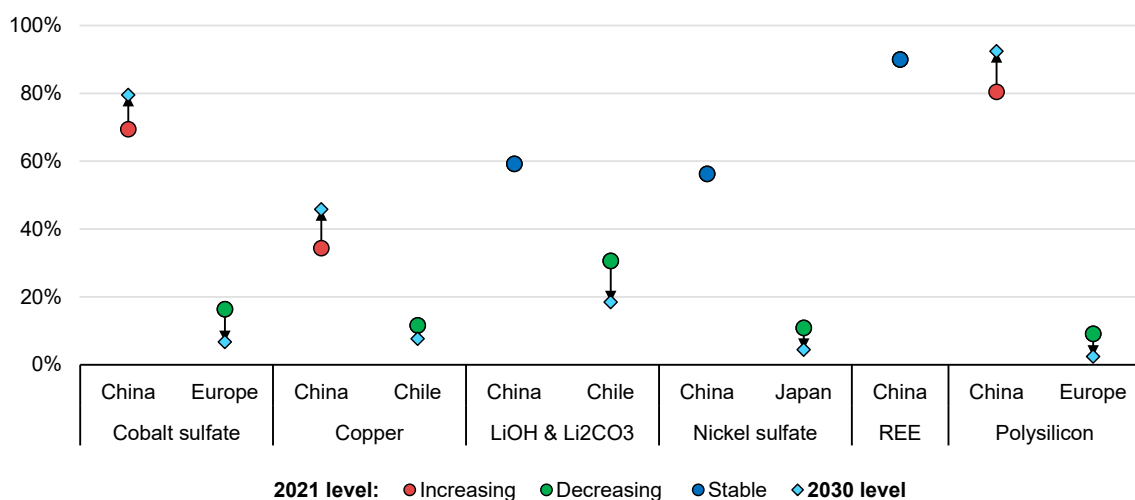

IEA. CC BY 4.0.

Note: LiOH = lithium hydroxide; Li₂CO₃ = lithium carbonate; REE = rare earth element. Stable is defined as a change of less than 3%. 2030 values based on anticipated capacity as seen in Figure 3.13.

Sources: IEA analysis based on IEA (2021); USGS (2022); BNEF (2022); BNEF (2020a); S&P Global (2022d); S&P Global (2022e); European Commission (2020); Frasel et al. (2021); InfoLink (2022); Eurometaux (2022).

Anticipated investments in critical material production capacity point to the continuing domination of China in global supply.

Regional policy and market developments

Policies to support investment in expanding critical material production have recently been introduced in several countries. **Indonesia** has been a leader in mining nickel ore for years, but most was exported to be processed elsewhere. To encourage local refining of nickel, the government introduced an export ban on nickel ore between 2014 and 2017 (Huber, 2021) and launched a policy in 2019 to increase the value added realised in the territory. As a result, its share of global refined nickel output rose from 1% in 2013 to 30% in 2021 (WBMS, 2022). The government wants to go even further in developing domestic supply chains by

prioritising the development of an EV industry, with a USD 1.1 billion battery plant, the first in the country, already in construction (BKMP, 2021). To further accelerate the transition to battery manufacturing, the Indonesian government intends to introduce a moratorium on the construction of new rotary kiln-electric furnaces, which are used to produce nickel pig iron (a low-value product, mostly used in the steel industry), in the hope of redirecting investment to nickel sulfate production for batteries (Setiawan, 2022).

Australia has an important role in the global mining industry but exports large shares of its extracted ore to other countries for processing. The Australian government strategy aims to move the economy towards downstream processing (Australia, Department of Industry, Science, Energy and Resources, 2022). Concrete results of this strategy include the Modern Manufacturing Initiative, which is providing funding of AUD 119.6 million for the development of nickel and cobalt battery material refineries; AUD 14.8 million has been allocated for REE processing and AUD 6 million for lithium hydroxide production (Nabanidham & Cook-Revell, 2022).

In the **United States**, the Infrastructure Investment and Jobs Act includes a USD 6 billion grant programme including USD 3 billion aimed to fund the domestic production of materials needed for the EV supply chain, including the refining of nickel, lithium and cobalt, as well as REEs (BGR Group, 2022). The Department of Defense awarded MP Material USD 35 million for the development of rare earth alloys and permanent magnet production capacity (White House, 2022).

In the **European Union**, two Important Projects of Common European Interest on batteries are directing public funding for the development of innovative projects for the processing of battery metals (IPCEI, 2022). The Commission is working on a Critical Raw Materials Act aimed at reducing the dependency on external suppliers with a focus on local production and recycling capacity (European Commission, 2022b).

CO₂ emissions

The energy intensity of processing critical minerals – the amount of energy needed to produce a tonne of material output – varies significantly by type of material, mineral quality and the process technology used (see Chapter 2). Energy intensity is a primary determinant of the emissions intensity of material production – the amount of CO₂ emitted per tonne of material output – the other factor being the types of energy used. Critical materials generally require more energy to produce than bulk materials, ranging from 20 GJ/tonne for copper to around 70 GJ/tonne for nickel.

Although emissions from critical material production are modest today in absolute terms, accounting for just 0.04% of global energy sector emissions, they would

grow rapidly if they were to continue to operate as they do today while supplying the levels of demand required in the NZE Scenario. Assuming constant energy intensities and fuel shares,²⁵ global CO₂ emissions from producing the five leading critical materials – copper, lithium, cobalt, nickel and neodymium – would more than triple to 55 Mt in 2030, lithium being the largest contributor of the increase. The increased use of these metals would contribute, however, to a significant net reduction in life-cycle emissions by enabling the deployment of clean energy technologies and infrastructure, even at today's emissions intensity.

There are opportunities to reduce emissions from the processing of critical minerals through best available technologies, increased electrification and fuel switching (from coal to natural gas for instance) in the near term. However, deeper decarbonisation of these processes, which require high-temperature heat, would require technology developments geared towards adapting existing processes to alternative fuels such as hydrogen and different types of biofuels, integrating CCUS more easily and viable direct electrification options. While alternatives are being developed for Li-ion batteries, innovation in net zero compatible production routes needs to accelerate to provide viable alternatives for all the other critical materials.

Copper production goes through two main routes today: pyrometallurgy, which uses smelting and accounts for around 80% of primary copper production today, and hydrometallurgy, which relies on acids and accounts for the remainder (Rötzer & Schmidt, 2020). Pyrometallurgy involves much higher temperatures and relies more on fossil fuels, while hydrometallurgy requires more chemical inputs. Those two routes are not exclusive to copper; other metals such as nickel can be produced using similar processes.

Fossil fuels are mainly used to process copper today, but alternatives are possible. Low-emission hydrogen or hydrogen-based fuels could be possible energy sources for the high-temperature smelting process. The company Aurubis is testing the use of low-emission ammonia to replace 20% of the natural gas used in its copper rod production plants (Evans, 2022). Other alternatives include CCUS or even renewable energy sources in tandem with high temperature heat storage. Technologies on the market today cannot easily accommodate these alternatives: the use of pure hydrogen requires adaptation of the equipment. Innovation and investments are needed.

Lithium is usually produced from either brine or spodumene, the latter being far more energy- and carbon-intensive (Figure 3.16). Most brine production is in South America. Mineral-rich brine is pumped from the ground and left in

²⁵ See footnote in previous section.

evaporation ponds for up to two years to concentrate the lithium chloride salt present in the brine. Multiple phases remove boron and magnesium from this brine. Soda ash is added for a precipitation reaction that yields lithium carbonate as a solid. This chemical can then be further treated with calcium hydroxide to produce lithium hydroxide. This process is not very energy-intensive as the sun powers much of the evaporation step and does not require high temperature, but does use a lot of chemicals with their own indirect emissions. In the case of lithium extracted from spodumene, the rock must be heated in a kiln for one hour at 1 100°C and then roasted at 250°C for ten minutes with sulfuric acid to produce lithium sulfate, from which lithium hydroxide is produced. These heating steps usually use coal to power the high-temperature kilns and steam production.

Figure 3.16 Emissions intensity of different lithium hydroxide production routes by fuel used and process temperature, 2021

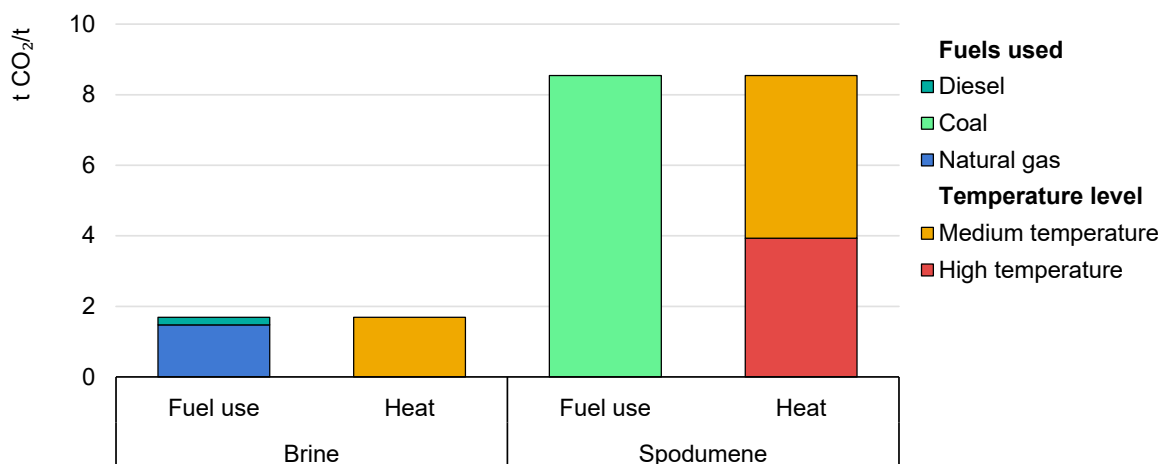

IEA. CC BY 4.0.

Notes: Only direct emissions for the processing steps are included, not mining. Medium temperature includes steam supply and high temperature covers spodumene kilns.

Source: Kelly et al. (2021).

Lithium hydroxide produced from hard rock is five times more emissions-intensive than from brine, half those emissions coming from hard-to-decarbonise high-temperature heat.

Considerable efforts are under way to develop cost-effective technologies to decarbonise those production routes. For the spodumene route, the Outotec process produces lithium hydroxide using soda ash instead of acid, leading to better yields, though high-temperature treatment of spodumene is still required (Metso Outotec, 2019). It may be possible to replace fossil fuels with renewable electricity or low-emission hydrogen or use carbon capture in this process, but little research exists so far.

Completely new production routes such as direct lithium extraction methods, which aim to extract lithium from brine without relying on large evaporation pools,

are also being developed. For instance, electrodialysis enables extracting high-purity lithium hydroxide directly from brine, requiring only electricity. However, this technology is still at the laboratory scale (Grageda et al., 2020; Zavahir et al., 2021). One of the most ambitious projects is being led by Vulcan Energy in Germany. Their geothermal plant will produce electricity for sale to the grid and use the heat derived to extract lithium from the geothermal brine (Vulcan, 2022).

Nickel sulfate production can take a number of routes. Traditionally, the most common route involved the use of high-purity nickel (Class 1) coming from higher-grade sulfide deposits. This route has the lowest CO₂ intensity of production, but there is relatively little scope to expand production. The recent increase in the availability of laterite ores (mostly from Indonesia) has increased the popularity of the route involving mixed hydroxide precipitate (MHP) as an intermediate step. First, laterite ore must go through a process called high-pressure acid leaching resulting in MHP containing a mix of nickel, cobalt and other elements. This precipitate is then refined to extract nickel sulfate. These production steps require a lot of electricity and chemicals, making this route more energy- and CO₂-intensive than the traditional route from Class 1 nickel (Dry, Vaughan & Hawker, 2019). Alternative routes for nickel sulfate include production from matte (yielding nickel that is around 75% pure), crude nickel sulfate derived from copper or platinum group metal production, and recycling (Le Gleuher, 2021).

Much of the nickel coming from Indonesia, which will account for a large portion of the growth in nickel mining capacity in the next few years, is likely to be very energy- and emissions-intensive, given that it has laterite ores rather than sulfide deposits. Thus, innovation to reduce the environmental impact of nickel production processes from laterite deposits are of utmost importance. Examples include hydrometallurgical techniques, which have been demonstrated only at laboratory or pilot scale, such as the direct nickel process (Total Materia, 2017). Direct use of renewables at production sites could also help reduce emissions. Some companies are already investing heavily in renewable power to satisfy their electricity needs such as the nickel producer Prony Resources in New Caledonia, which aims to have two-thirds of its electricity supplied by a combination of solar power and battery storage in 2025 (Prony Resources, 2021).

The production of critical materials is part of the non-ferrous metal sector which, if aluminium is excluded, was responsible for emitting 65 Mt of CO₂ globally in 2021. This is the equivalent of only 2% of the 2.8 Gt of CO₂ emissions from the iron and steel sector. It is important to note that even if critical material extraction and production are relatively carbon-intensive today, the clean energy technologies such as EVs they support still bring major reductions in life-cycle CO₂ emissions (see Chapter 2). Emissions from critical material production are, in any case, much smaller than those from bulk material production (see below).

Bulk material production

Expansion plans and gaps compared with the NZE Scenario

Demand for steel and cement grows modestly in the short term and is relatively stable over the longer term in the NZE Scenario, as reductions from material efficiency more than outweigh modest increases in demand from clean energy technologies and infrastructure (see material demand and efficiency sections above). While demand growth is stronger for aluminium and plastics relative to steel and cement, it is much more modest than the growth for critical materials. Given this modest growth, as well as the widespread availability of raw materials, there would not be a major risk of supply bottlenecks for bulk materials in this scenario. Production capacities in most cases are already sufficient to meet projected demand, and capacity could most likely be increased sufficiently for those materials for which demand increases.

However, current conventional capacity is emissions-intensive, due to a combination of heavy reliance on fossil fuels and process emissions that result from chemical reactions in conventional production methods. In the NZE Scenario, conventional capacity is rapidly replaced by near zero emission technologies, through either retrofits or new capacity additions, far outpacing the total growth in bulk material demand.²⁶ Total primary steel production actually falls by about 30 Mt between 2021 and 2030, while near zero emissions primary output increases by about 130 Mt (Figure 3.17). For cement, near zero emission production rises more than twice as much as total demand over the same period.

The global average direct emissions intensity of bulk material production falls between 20 and 30% from 2021 to 2030 in the NZE Scenario, depending on the material. Indirect emissions from electricity production fall even more rapidly. By 2050, direct emissions from all bulk materials fall in absolute terms by nearly 95%, and indirect emissions are fully decarbonised.

A considerable portion of the emissions reductions in bulk material production to 2030 in the NZE Scenario come from incremental improvements to existing conventional production routes, such as improved energy efficiency, partial blending of alternative fuels such as bioenergy and reductions in indirect emissions through use of zero emission electricity. In some cases, these improvements are a step on the way to near zero emissions production in the longer term. For example, the steel sector is blending increasing portions of electrolytic hydrogen into direct reduced iron (DRI) units that could eventually be capable of using 100% electrolytic hydrogen.

The material efficiency improvements discussed earlier in this chapter play a significant role too, both by reducing the overall demand for bulk materials and by providing more recycled materials for secondary production. However, primary production cannot be

²⁶ The IEA has proposed definitions for low and or near zero emission steel and cement production in the report *Achieving Net Zero Heavy Industry Sectors in G7 Members* (IEA, 2022e). They are designed to be stable, absolute and ambitious, and they are compatible with a trajectory that reaches net zero emissions from the global energy system by mid-century. A complementary set of definitions for low-emission production was also proposed, to recognise the important interim steps taken towards lower emissions intensity and in particular towards achieving near zero emission production.

fully replaced. Some materials remain locked “in use” for decades for some major end uses such as buildings and infrastructure, and total demand is higher than it was decades ago, so the availability of recycled material inputs will be insufficient to fully replace the need for primary production, at least over the next multiple decades. In the case of cement, full recycling is not technically possible, though innovation is under way to recover some portions of cement for recycling.

Figure 3.17 Production of bulk materials by country/region and type of technology in the NZE Scenario

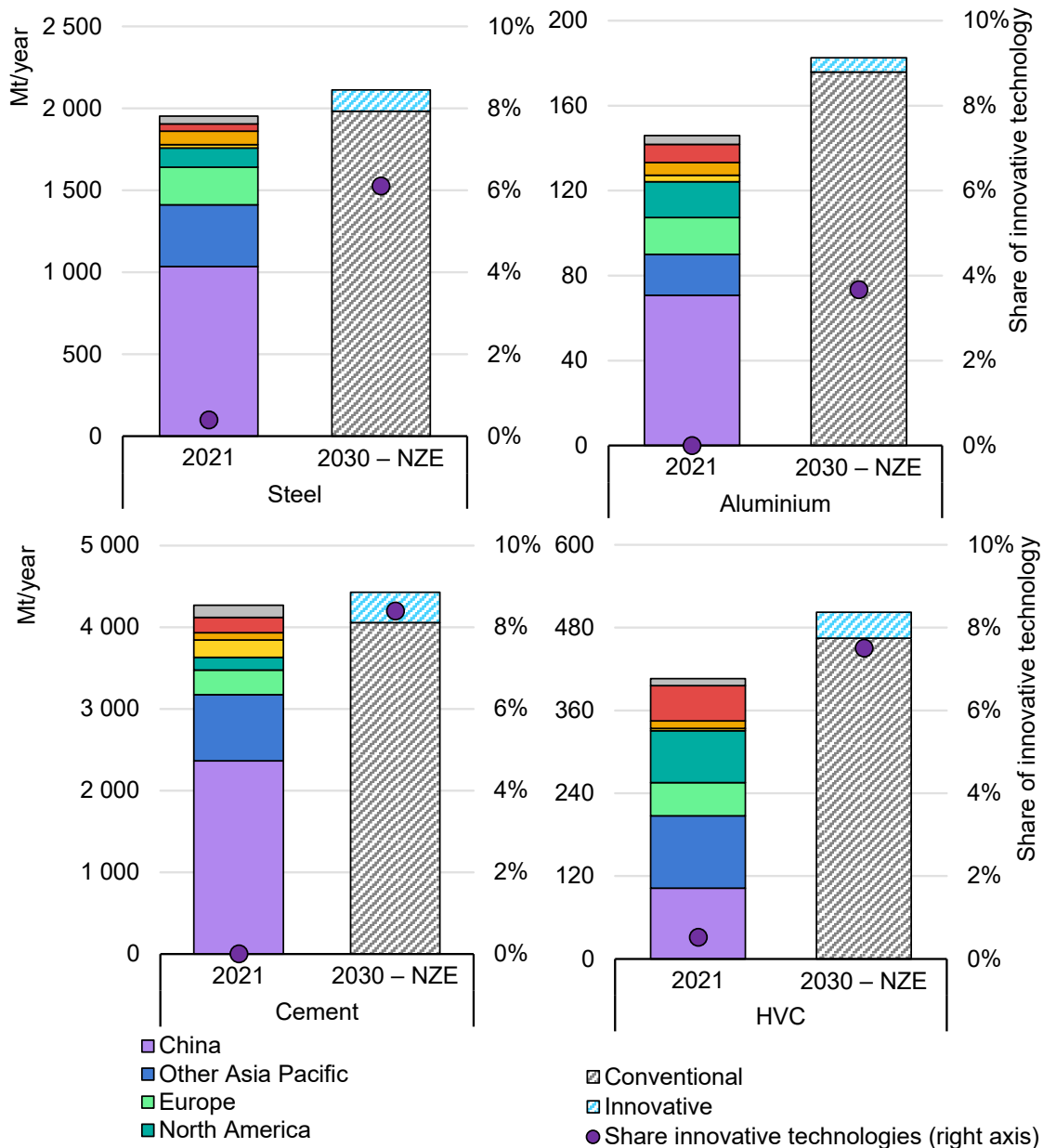

IEA. CC BY 4.0.

Notes: NZE = Net Zero Emissions by 2050 Scenario; Innovative = near zero emissions primary production routes; HVC = high-value chemicals (ethylene, propylene and aromatics), which are mainly used to produce plastic. Other Asia Pacific excludes China.

Global production of bulk materials grows modestly to 2030 in the NZE Scenario, but material production with innovative near zero emission technologies increase rapidly.

The development and deployment of near zero emission primary production methods for bulk materials is needed urgently for the world to get on track for net zero emissions by 2050. While research, development and demonstration (RD&D) efforts are under way on various technologies, efforts will need to be stepped up to bring these technologies to the commercialisation stage within the next few years. In the NZE Scenario, early commercial deployment occurs from the mid-2020s, such that innovative near zero emission process routes account for about 4-8% of total production by 2030. This early deployment is crucial not only to achieve emissions cuts, but also to achieve the technology learning, cost reductions and supporting infrastructure scale-up needed for their rapid large-scale deployment from 2030.

Near zero emission technologies for bulk materials centre largely around hydrogen, direct electrification, CCUS and alternative raw materials. The options vary by material. For steel, electrolytic hydrogen plays a leading role in the NZE Scenario, particularly in the DRI route, as does CCUS-equipped production. Direct electrification through iron ore electrolysis is also possible. For cement, CCUS is the main path to near zero emission production, given that two-thirds of emissions come from the process itself rather than the combustion of the fuels used to provide heat. Use of alternative raw materials that do not produce process emissions is another option, along with potential to electrify thermal energy needs in the kiln. For plastics production, CCUS and direct electrification play an important role. For aluminium production, there are two main sources of direct emissions to tackle: high-temperature heating for alumina refining and process emissions from the decomposition of anodes in aluminium smelting. Use of bioenergy, hydrogen, solar thermal and electricity are options to tackle alumina refining. Anodes made from alternative inert materials are the most advanced solution for aluminium smelting, while CCUS is also being explored.

Box 3.4 Plans for near zero emission material production

Industrial producers around the world are undertaking projects to reduce emissions from producing bulk materials. To evaluate how current announcements stack up against what is required in the NZE Scenario, we consider two categories of projects, based around the production definitions of near zero emission material production proposed in the report *Achieving Net Zero Heavy Industry Sectors in G7 Members* (IEA, 2022e):

- **Near zero emission:** projects that, once operational, will be near zero emission from the start, e.g. a cement plant capturing nearly all CO₂ emissions; a DRI-based steel plant operating fully on hydrogen produced from renewable electricity.

- **Near zero emission capable:** projects that will achieve substantial emissions reductions from the start – but fall short of near zero emissions initially – with plans to continue reducing emissions over time such that they could later achieve near zero emission production without substantial additional capital investments in core process equipment, e.g. a CCUS-equipped cement plant capturing only process emissions initially, with plans to transition to zero emission fuels to eliminate combustion emissions; a DRI-based steel plant gradually blending increasing shares of electrolytic hydrogen, displacing its initial use of natural gas.

Projects that will achieve substantial emission reductions but do not have plans to continue reducing towards near zero emissions (e.g., a cement plant with an electric kiln but no plans to capture process emissions, a blast furnace-based steel plant with partial blending of electrolytic hydrogen) are not included in either of these two categories.

Based on our assessment, announced projects today have the potential to deliver 13 Mt per year of near zero emission primary steel production by 2030, or around 10% of the level reached in the NZE Scenario. These figures exclude scrap-based production, for which near zero emission production can be achieved with only minor alterations to existing process technology, together with the use of low carbon electricity.

For projects that do not achieve near zero emission production initially, but plan to do so over time – without substantial additional capital investments in core process equipment – it is not always clear if, and by when the transition will take place. This is particularly the case in the iron and steel sector for natural gas-based DRI plants, for which project announcements increasingly mention the use of hydrogen, but often do not specify key details, such as the share of low-emission hydrogen that is targeted, the timeframe for achieving it or the source of the hydrogen.

Based on our assessment of announced projects with plans to transition over time, we identify a further 55 Mt per year of near zero emission *capable* primary steel production that could materialise by 2030. *If* the transition of all these projects were fully complete by 2030, the total announced near zero emission primary steel production would equate to just under half of that required in the NZE Scenario by that time. Nearly all of the announced projects are for hydrogen-based DRI plants, alongside a smaller number of CCUS-equipped projects. More than 60% of the announced capacity is in Europe.

Figure 3.18 Estimates of near zero emission material production based on project announcements and the NZE Scenario in 2030

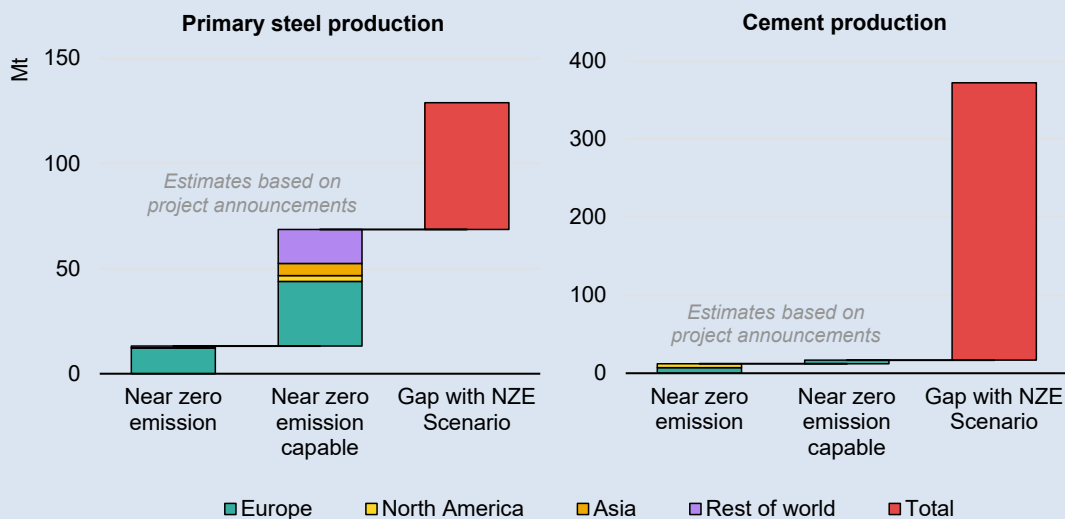

IEA. CC BY 4.0.

Notes: NZE = Net Zero Emissions by 2050 Scenario. “Near zero emission” and “Near zero emission capable” production, as defined in the text above, are assessed based on project announcements, many of which contain incomplete information, and are subject to change.

Sources: Company announcements; Agora Energiewende (2021).

For cement, announced projects we assess are likely to achieve near zero emission production from the start – and are scheduled to be operational by 2030 – amount to about 12 Mt per year of cement production. All of these projects involve the use of CCUS, and their combined output equates to around 3% of the near zero emission cement production in 2030 in the NZE Scenario. An additional 5 Mt per year of production from announced projects that are assessed to be near zero emission capable are also forthcoming (Figure 3.18). These are either projects that initially plan to capture only a portion of the plant’s emissions, or where carbon capture is planned but it is unclear if the CO₂ is intended to be permanently sequestered. If all of these projects did achieve near zero emission production, the total output would amount to 5% of the levels in the NZE Scenario in 2030. Of these projects, most are still in the concept or feasibility stages and only one is under construction. About two-thirds of planned capacity is in Europe and the rest in North America.

Increased transparency in announced project plans – such as details on target capacity and production levels, intended start-up dates, and key operational parameters (e.g., target levels and source of any hydrogen used; the intended use or fate of captured CO₂) – would have several advantages. It would make possible more robust tracking of progress towards net zero goals. It would help more easily

connect producers with potential buyers, who are increasingly making commitments to purchase near zero emission steel and cement (see Chapter 6). It would also facilitate more open dialogue and in turn help accelerate progress on the gaps to achieve near zero emission material production, such as coordination of, and investment in, low emission hydrogen supply and CO₂ transport and storage infrastructure. Once projects are operational, transparent data on realised production volumes, emissions etc. would further support these objectives.

Geographical distribution

The geographical concentration of bulk material production, which is already considerably lower than that of critical material production, would not change much before the end of the current decade based on current investment plans. China is by far the largest producer of bulk materials, accounting for 25-55% of global production today, depending on the material. Much of the rest of production is relatively dispersed among multiple producing countries. In many countries, much of the output of bulk materials goes to the domestic market, but international trade is important in some cases. Around 20% of steel production and 40% of aluminium are traded as semi-finished products. Additional trade occurs through materials embedded in end-use products. Those trade networks are well established and carry volumes much higher than for critical materials, which implies lower risk when there is some degree of geographical concentration. In the case of cement, most production is carried out close to centres of demand due to high transport costs, so geographical concentration is inherently less of a concern.

There is no major regional redistribution of bulk material production during the current decade in the NZE Scenario (Figure 3.19). The main exception is China, which sees marginal falls in its shares of steel output (by 3 percentage points), cement (7 percentage points) and aluminium (by 4 percentage points), between 2021 and 2030 due to declining domestic needs as its economy matures. It nonetheless continues to dominate global supply. By contrast, strong economic growth in some other emerging economies, notably India, results in an increase in their shares of global production of these materials.

Figure 3.19 Shares of the leading regions in global production of selected bulk materials in 2021 and 2030 in the NZE Scenario

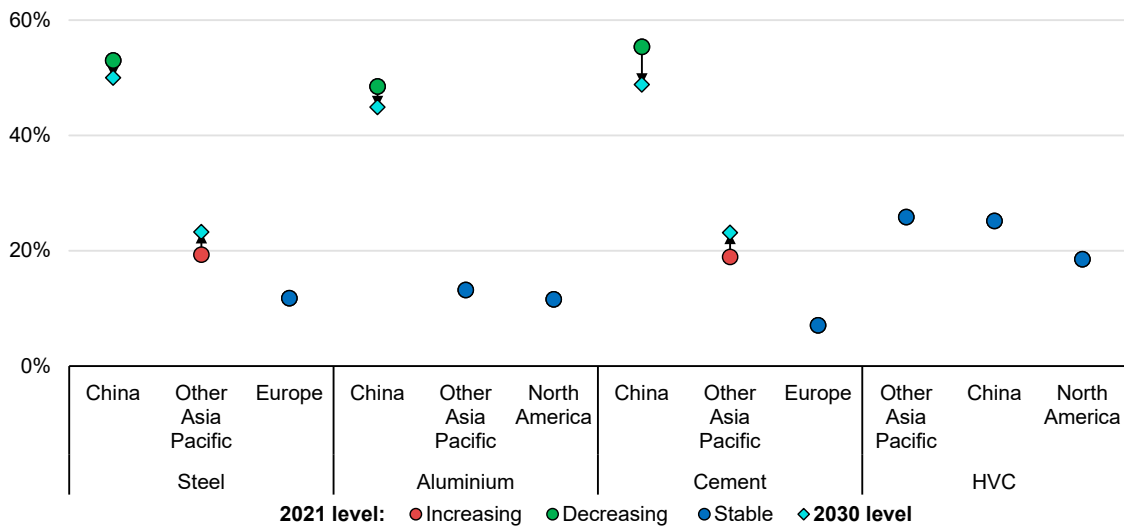

IEA. CC BY 4.0.

Notes: CSA = Central and South America; HVC = High value chemicals, the main input for making plastics. Other Asia Pacific excludes China. Stable is defined as a change of less than 2%.

Source: IEA analysis based on USGS (2022); World Steel Association (2022); IAI (2022).

Bulk material production continues to be dominated by China, though its market share is set to decline slightly for steel, cement and aluminium.

Policy and market developments towards near zero emissions

Government policies are increasingly pushing companies involved in bulk material production to re-evaluate their portfolios and plan for the clean energy transition. This includes net zero emission targets, broader emissions reductions plans and industry-focused roadmaps. Carbon pricing systems applied to industry, such as the EU’s Emissions Trading System (ETS), Canada’s output-based carbon price and Korea’s ETS, are starting to improve the economics of lower-emission production. EU plans to introduce a carbon border adjustment mechanism may be starting to put pressure on companies that export to the Union.

Many technologies for near zero emission production are not yet market-ready and will have considerably higher costs at least initially. As a result, broader plans and carbon pricing at moderate levels are likely insufficient to drive initial roll-out, and so policies targeting near zero emission production are needed. This includes supply “push” policies that help with large upfront capital investments and demand “pull” policies that provide confidence that there will be a buyer despite the higher cost of production. They are complementary and thus both are critical. Technology readiness is currently a key bottleneck, in that even material users willing to pay a premium to decarbonise their supply chains are finding there is a relative scarcity of near zero emission materials expected to be available in the coming years. This suggests that current commitments for purchasing near zero emission materials –

while important to help address the “pull” side – are insufficient on their own to overcome the risks of investing in innovation to bring these technologies to market. Conversely, even with substantial investment support to develop and build near zero emission plants (the “push” side), the business case for doing so is missing without confidence that there will be a buyer willing to pay a premium for the materials produced.

Table 3.2 Examples of government supply-side support for low-emission material production

	Europe	North America	Asia and Oceania
Steel	<ul style="list-style-type: none"> EU innovation fund and Swedish Energy Agency: Hybrit Spain’s Recovery and Resilience Plan, French and Belgian government investments: ArcelorMittal (DRI) 	<ul style="list-style-type: none"> Canada’s Net Zero Accelerator: ArcelorMittal (DRI) US 45Q/48C CCUS and 45V/48C hydrogen deployment tax credits Canada CCUS Investment Tax credit 	<ul style="list-style-type: none"> Japan Green Innovation Fund (hydrogen-based steel making)
Cement	<ul style="list-style-type: none"> EU Innovation fund: EQIOM (CCS: K6 programme), Holcim (CCS: GO4ECOPLANET, Carbon2Business), Heidelberg Materials member company Devnya (CCS: ANRAV-CCUS) Norwegian Longship programme: Heidelberg Materials member company Norcem (CCS: Brevik) 	<ul style="list-style-type: none"> US 45Q/48C CCUS tax credits Canada CCUS Investment Tax credit US Infrastructure Investment and Jobs Act: funding for CCUS US Department of Energy’s National Energy Technology Laboratory: Holcim (CCS) National Research Council of Canada Industrial Research Assistance Program: Holcim (CCUS) Emissions Reduction Alberta: Heidelberg Materials member company Lehigh (CCS) 	
Plastics	<ul style="list-style-type: none"> EU Innovation fund: Neste (recycling), Metsä Group (bio-based plastics), BASF (CCS) 	<ul style="list-style-type: none"> US 45Q/48C CCUS tax credits Canada CCUS Investment Tax credit 	<ul style="list-style-type: none"> Japan National Budget (recycling)
Aluminium	<ul style="list-style-type: none"> North-Rhine Westphalia state funding: Arctus and TRIMET (inert anodes) 	<ul style="list-style-type: none"> Canadian and Quebec government funding: Elysis (inert anodes) 	<ul style="list-style-type: none"> Australian Renewable Energy Agency: Aloc, Rio Tinto (zero emission fuels for alumina refining)

Sources: HYBRIT (n.d.); ArcelorMittal (2022a, b); ArcelorMittal (2021a, b); Brevik (2022); European Commission (2022c); Holcim (2020); Lafarge (2019); Emissions Reduction Alberta (2020); International Energy Agency (2022f); Elysis (n.d.); Trimet (n.d.).

Several governments have recently introduced measures to speed up the adoption of low-emission technologies in bulk material production. For example, on the supply side, the US Infrastructure Investment and Jobs Act enacted in November 2021 and the IRA of August 2022 allocated funding for such technologies, particularly CCUS and hydrogen, while the RePowerEU plan launched on 18 May 2022 increased funding to renewables and hydrogen. On the demand side, Japan's GX League policy, launched in February 2022, is encouraging private-sector actors to reduce their supply chain emissions, while the Federal Buy Clean Initiative by the US, announced as part of an executive order in December 2021, will provide support through public procurement of lower-emission materials. Multiple other public- and private-sector efforts are driving increased momentum for near zero emission materials.

Table 3.3 Examples of government demand-side policies for low-emission material production and private- and public-sector commitments

	Steel	Cement	Plastics	Aluminium
Direct private-sector purchase agreements	<ul style="list-style-type: none"> • Vehicle manufacturers (e.g. Volvo, General Motors, Mercedes-Benz) • Power companies (e.g. Ørsted) • Equipment manufacturers (e.g. Miele, Lindab) 			
Private-sector demand creation initiatives	<ul style="list-style-type: none"> • SteelZero • First Movers Coalition 	<ul style="list-style-type: none"> • ConcreteZero • First Movers Coalition 	<ul style="list-style-type: none"> • First Movers Coalition 	<ul style="list-style-type: none"> • First Movers Coalition
Private-sector targets to reduce life-cycle emissions	<ul style="list-style-type: none"> • Vehicle manufacturers: Daimler, Volvo Cars, Hyundai, Toyota, Ford, Nissan, BMW, Renault, GM, BMW • Construction: Lendlease, Balfour Beatty, Skanska, Bouygues Construction 	<ul style="list-style-type: none"> • Construction: Lendlease, Balfour Beatty, Skanska, Bouygues Construction 		<ul style="list-style-type: none"> • Vehicle manufacturers: Daimler, Volvo Cars, Hyundai, Toyota, Ford, Nissan, BMW, Renault, GM, BMW
Public procurement	<ul style="list-style-type: none"> • CEM IDDI • US IRA provisions 	<ul style="list-style-type: none"> • CEM IDDI • US IRA provisions 		<ul style="list-style-type: none"> • US IRA provisions
Other public policies with demand creation potential	<ul style="list-style-type: none"> • Germany's CCFD • France's RE 2020 regulation 	<ul style="list-style-type: none"> • Germany's CCFD • France's RE 2020 regulation 	<ul style="list-style-type: none"> • Germany's CCFD 	<ul style="list-style-type: none"> • Germany's CCFD • France's RE 2020 regulation

Sources: Company, government and non-governmental organisation announcements.

Steel

The global steel industry has a large number of players, with 113 steel companies each producing more than 2 Mt in 2021 (World Steel Association, 2022). The top ten producers account for about a quarter of global production. Most are headquartered in Asia, mainly China, Japan, Korea and India; only one is in the European Union. Many are multi-nationals with operations around the world. Most of the leading producers are in China, which accounts for 53% of global production today, compared with 8% in the European Union and 6% in North America.

Near zero emission steel can be produced using innovative primary production routes with sufficient emissions reductions and also scrap-based electric arc furnace (EAF) production if using zero emission electricity to eliminate indirect emissions and also minimising residual on-site direct emissions. Given limitations in scrap availability, it will be important to develop near zero emission primary routes in parallel to achieving near zero emissions in scrap-based production.

Today, to our knowledge, only one project in the world operating at commercial scale could qualify as near zero emission primary production: a natural gas DRI-EAF plant with CCS in the United Arab Emirates operated by Emirates Steel Industries, capturing 0.8 Mt CO₂ per year. Additionally, about 150 Mt of natural gas or coal DRI-EAF is produced annually, most of which would have the technological capability to relatively easily transition to near zero emissions by converting to run on zero- or low-emission hydrogen – a number of furnace models may require some low-risk equipment modifications to enable this, while some of the more advanced furnaces would require no equipment changes (Astoria, Hughes & Mizutani, 2022). Meanwhile, there is about 310 Mt of scrap-based EAF production annually, which could approach near zero emissions levels through full use of zero emission electricity and efforts to minimise residual on-site emissions.

As of mid-2022, 124 Mt/year of steel capacity additions have been announced that have the potential to achieve near zero emissions if converted over time to run from zero or low-emission electricity and hydrogen (Agora Energiewende, 2021). About half of these are scrap-based EAF and the other half natural gas- and or hydrogen-based DRI-EAF. Most of these announced projects, however, are not yet backed by final investment decisions. In the case of DRI-EAF plants, many announcements discuss plans to gradually transition from natural gas to low-emission hydrogen as inputs, although the specific plans are not fully clear in many cases for the portion of hydrogen that will be eventually used and by when. Only one known CCUS project with potential to qualify as near zero emissions – if the captured CO₂ were transported to a permanent storage site – is expected to be online by 2030 – the 3D project by ArcelorMittal applying carbon capture to a blast furnace in France, which would be able to capture about 1 Mt of CO₂ per year. While there are also several carbon capture and utilisation (CCU) projects already operating or under development that make use of carbon-rich blast furnace off-

gases, these would not be considered near zero emission given that the produced fuels or chemicals would later release the CO₂ to the atmosphere.

For comparison to current and announced capacity additions, in the NZE Scenario, there is about 130 Mt near zero emission primary production by 2030 globally. Given the over 200 Mt of total DRI-EAF capacity that would be online if announced plans were realised (including announced and existing capacity), there is good potential for sufficient near zero emission-ready steel capacity to be in place. A major caveat however is that these plants would need to run fully on low-emission hydrogen to reach near zero emissions levels – announced plans suggest there will be a major shortfall in this regard.

Table 3.4 Top steel producers and leading existing or planned projects making progress towards near zero emission steel production

	Europe	North America	Asia	Rest of world
Top producers (location of headquarters)	<ul style="list-style-type: none"> ArcelorMittal 		<ul style="list-style-type: none"> China Baowu Ansteel Shagang HBIS Jianlong Shougang Nippon Steel POSCO Tata Steel 	

Producers undertaking projects towards near zero emission production:

DRI*	<ul style="list-style-type: none"> H2 Green Steel* SSAB (Hybrit project)* ArcelorMittal TataSteel Thyssenkrupp Saarstahl Liberty Salzgitter 	<ul style="list-style-type: none"> Nucor ArcelorMittal North America 	<ul style="list-style-type: none"> HBIS Baosteel Sinosteel POSCO 	
CCUS	<ul style="list-style-type: none"> ArcelorMittal (3D project) 			<ul style="list-style-type: none"> Emirates Steel
Electrification	<ul style="list-style-type: none"> ArcelorMittal (Siderwin project) 	<ul style="list-style-type: none"> Boston Metal Electra Steel 		

* For DRI, producers marked with an asterisk are working towards projects that will be fully fuelled by electrolytic hydrogen from the start; other projects are DRI plants that could transition to full electrolytic hydrogen in future (some producers have stated explicit plans for this, others have not stated additional details).

Note: A number of producers are included in this list that are undertaking projects that could develop technologies to aid near zero emission production, but no clear plans have yet been announced for fully near zero emission capacity additions. This explains the contrast between the list here and announced projects in Figure 3.18.

Sources: Company, government and non-governmental organisation announcements; World Steel Association (2022).

Much of the momentum around hydrogen-based DRI is in the EU (IEA, 2022e). The first commercial-scale fully electrolytic hydrogen-based DRI plants are expected to come online already in the 2024-2026 period in EU – these may include plants by start-up H2 Green Steel (2.5 Mt in Sweden) and the Hybrit

project involving SSAB (1.2 Mt in Sweden). Other projects planned in Europe, as well as a smaller number of projects in North America and China, will initially be fuelled fully or partially with natural gas or other fossil fuel-derived gases. Some have explicitly stated plans to transition to electrolytic hydrogen as it becomes available. While additional scale-up efforts are needed to demonstrate 100% use of hydrogen at commercial scale, Tenova's Energiron DRI technology was used to successfully prove fully hydrogen-based ironmaking at pilot scale in the Hybrit project. This technology is being used for several of the planned DRI projects, including those in China, which provides a positive indication for potential to transition to near zero emission production.

There is also growing momentum around iron ore electrolysis, which although still at the pilot stage could have considerable growth potential. Much of the activity is led by venture capital-backed US-based start-ups, with the earliest Boston Metal aiming for commercial deployment from 2026 and Electra Steel in the late 2020s. ArcelorMittal is also developing iron ore electrolysis through the Siderwin project in France, also aiming for commercial scale in the late 2020s.

Meanwhile, recent progress on applying CCS to the steel industry has been modest. Besides the already mentioned Emirates Steel Industries plant in the United Arab Emirates and the 3D project in France, the Course50 project in Japan continues to work towards applying carbon capture to the blast furnace, although it is not expected to be rolled out this decade (commercial-scale demonstration only is targeted by 2030). Plans are uncertain regarding the future of the HIsarna innovative smelting reduction with CCUS technology. Following a successful pilot project in IJmuiden, Netherlands, Tata Steel announced that it would instead pursue hydrogen DRI at the IJmuiden plant. Plans are still under way to develop a second large-scale pilot plant (0.5 Mt) employing the HIsarna smelting reduction technology in India, but there are no announced plans to include CO₂ storage in that demo plant. It is to be seen whether recent policy and market developments, such as CCUS-related incentives in the US IRA and higher natural gas prices, could give a boost to plans to apply CCS to the steel industry, including on coal-based blast furnaces.

There is a notable absence of near zero emission-capable projects in several major emerging market and developing economies, where much of the future growth is expected. For example, India steel production is expected to nearly triple (to reach nearly 350 Mt) between now and 2050 in the NZE Scenario, yet virtually all planned primary capacity additions are for conventional blast furnace-based production without CCUS. International finance mechanisms – targeted towards near zero emission production routes and designed to mobilise private capital – could help to close this gap through support for capital investments. While there are some emerging efforts in this area, for example the recently developed Climate Investment Funds Industry Transition programme, much more is needed. Other

complementary policies, such as demand creation mechanisms or domestic carbon pricing, would also likely be needed to make the business case for such projects given higher operating costs.

Many of the projects announced to date are receiving some form of direct government support for RD&D and deployment. A smaller number of projects are instead relying mostly or solely on private capital. This includes the already-noted US start-ups working on iron ore electrolysis, and also H2 Green Steel, which has raised funds through equity financing rounds (H2 Green Steel, 2022). Funding available via recently enacted policies, such as the US IRA, could serve to catalyze additional projects in the coming years.

On the demand-pull side, the most direct support has come from direct private-sector purchase agreements. Various end-user companies have made commitments to purchase near zero emission steel from companies such as SSAB, Salzgitter, Nucor and H2 Green Steel. Although not providing as strong a demand-pull signal as a direct purchase commitment, several other private-sector initiatives and public policies are signalling to steel producers a likely growing market for near zero emission steel. Key initiatives to create demand from the private sector include SteelZero (an initiative of Climate Group and ResponsibleSteel) and the First Movers Coalition (launched by the US government), which collectively cover over 40 companies. In terms of public procurement, the Clean Energy Ministerial's Industrial Deep Decarbonisation Initiative (CEM IDDI) has developed a Green Public Procurement Pledge, through which member countries are expected to announce commitments to low and near zero emission steel procurement over the course of 2023. Other demand-pull policies at the national level include Germany's exploratory call for proposals this past May for carbon contracts for difference (CCfD) in energy-intensive industries, including steel (by helping bridge the cost gap between conventional and near zero emission production, a CCfD would help steel producers sell near zero emission production at current market rates and thus reduce the challenge of finding a buyer); France's RE2020 buildings regulation that set embodied carbon targets for buildings construction; and the US IRA provisions (sections 60503 and 60506) that together allocated over USD 4 billion for the purchase of low-carbon construction materials for government buildings and government-funded highways.

Cement

The global cement industry likewise has a large number of players. The top ten producers account for just under 30% of global production, and are relatively distributed geographically (BizVibe, 2020a). The top four producers alone account for 20% of production: two European-based multinationals with affiliate companies and production widespread globally (Holcim and Heidelberg Materials) and two

Chinese companies (Anhui Conch and China National Building Materials). The other producers in the top ten are headquartered also in Europe and Asia, as well as Latin America and Eurasia. The wider dispersion of major countries is explained by the fact that cement is often produced relatively close to where it is consumed and is not widely traded internationally (see Chapter 2).

The largest challenge for producing cement with near zero emissions is to address the process CO₂ emissions from calcination, which account for about two-thirds of emissions. CCS is currently the most advanced solution overall, with multiple different capture technologies at different stages of technology readiness. It is important to consider where the CO₂ will end up to determine whether it is truly near zero emissions – unless CO₂ use results in permanent storage (e.g. in building materials), the CO₂ would need to be stored in dedicated permanent storage facilities. While CCU applications without permanent storage have value in the near term in providing a business case to advance carbon capture technologies and may continue to play a modest role in some specific applications in the longer term in a world transiting to net zero, scale-up of supporting CO₂ transport and storage infrastructure will be critical to enable widespread truly near zero emission cement production.

Reducing the clinker to cement ratio through increasing the use of supplementary cementitious materials (SCMs) will also be important to reduce emissions. Here, calcined clay and lime are expected to play an increasing role, as availability of conventional SCMs – particularly fly ash from coal plants and ground granulated blast furnace slag from steel production – considerably declines due to clean energy transitions. However, SCMs are unlikely to be able to achieve near zero emissions production alone, given that the current known technical minimum clinker requirement in cement for most applications is 50%.

With regard to carbon capture, the first full-scale project for cement is expected to come online in 2024 – the Brevik plant in Norway, operated by Norcem (a member of Heidelberg Materials Group) that will capture 0.4 Mt CO₂/year, or half of the plant's emissions, using chemical absorption. In total, there are projects at cement plants in the pipeline that are expected to capture about 10 Mt CO₂/year by 2030 if including only projects with announced planned start dates, or 15 Mt CO₂/year if assuming all announced projects as of today will have sufficient time to start by 2030 (values exclude projects that have stated plans to use the CO₂ in ways that will not lead to permanent storage). This is only about 6 to 9% of the approximately 175 Mt captured and stored in 2030 in the NZE Scenario, signalling a large gap between planned capacity additions and that needed to get on track for net zero by 2050. Of the planned capacity additions, most are in Europe and North America; a handful of pilot or demonstration projects are also taking place in Asia. It is worth also noting the important role of other companies within the CCUS value chain in enabling cement CCUS projects, including CO₂ capture

technologies providers (e.g. Svante, Mitsubishi Heavy Industries Group, Aker Carbon Capture, Carbon Clean) and companies involved in CO₂ transport and storage (e.g. Oxy Low Carbon Ventures, Equinor, Enbridge, Carbon Collectors).

Table 3.5 Top cement producers and leading existing or planned projects making progress towards near zero emission cement production

	Europe	North America	Asia	Rest of world
Top producers (location of headquarters)	<ul style="list-style-type: none"> • Holcim • Heidelberg Materials (including member company Italcementi) 		<ul style="list-style-type: none"> • Anhui Conch • China National Building Materials • China Resources Cement • Taiwan Cement 	<ul style="list-style-type: none"> • Cemex • Votorantim • Eurocement

Producers undertaking projects towards near zero emission production:

CCUS	<ul style="list-style-type: none"> • Heidelberg Materials Group (including member companies Norcem, Hanson UK, Cementa, Italcementi, Devnya) • Holcim • Buzzi Unicem (including member company Dyckerhoff) • Cemex • Schwenk • Vicat • Lhoist • CRH (including member companies EQIOM, Tarmac) • FLSmidth • Titan • Aalborg Portland • CIMPOR - Indústria de Cimentos 	<ul style="list-style-type: none"> • Heidelberg Materials Group (including member company Lehigh) • Holcim • Cemex 	<ul style="list-style-type: none"> • Taiwan Cement • Dalmia Cement • Taiheiyu Cement • Anhui Conch • BBMG Corporation • China Resources Cement 	<ul style="list-style-type: none"> • Boral
Alternative raw materials	<ul style="list-style-type: none"> • CEMEX • Materrup 	<ul style="list-style-type: none"> • Brimstone • Solidia • Terra CO₂ • Fortera 		

Note: A number of producers are included in this list that are undertaking projects that could develop technologies to aid near zero emission production, but no clear plans have yet been announced for fully near zero emission capacity additions. This explains the contrast between the list here and announced projects in Figure 3.18.

Sources: Company, government and non-governmental organisation announcements; BizVibe (2020a).

Aside from CCUS, another technology category that could substantially reduce or even eliminate process emissions are clinkers or alternative binding materials based on raw materials other than limestone. While multiple technologies are under development, there are various challenges related to suitability for a diversity of applications and raw material availability, or some lead to only partial emissions reductions. Some alternatives are already being produced at commercial scale but have only been used in certain large non-structural

applications (e.g. Solidia Cement). Other technologies are in earlier stages of development but could be very promising if commercialised. For example, US-based start-up Brimstone has successfully produced at lab scale a zero-emission cement with a chemical composition identical to ordinary Portland cement clinker (thus overcoming challenges related to limitations to the applications for which they can be used and regulatory barriers to adoption) that can achieve zero or even negative emissions and is aiming for demonstration by 2024. Electric kilns could also help eliminate fuel combustion emissions – several projects are working towards developing this technology, including successful pilot-scale trials by VTT in Finland.

As with steel, the concentration of activity to deploy near zero emission cement production is largely in advanced economies, despite the expectation that emerging market and developing economies will continue to account for much of future production (about 85% in 2050 in the NZE Scenario). This signals the need for greater international finance support, as well as collaboration through technology co-development, capacity building and knowledge sharing. Likewise, much of currently planned CO₂ transport and storage infrastructure is in North America and Europe, which indicates a need for expanded scale-up in other parts of the world.

Government financial support is an important enabler of many of the ongoing and planned projects. In addition to government funding through grants, tax incentives can be helpful in driving increased investments in emissions-reducing projects. In the United States, the 45Q tax credit for CCUS was expanded and extended through the IRA, legislated in August 2022: the credit for CO₂ captured from power and industrial plants has been nearly doubled, and the deadline to qualify for the credit is extended by seven years to 2033. In Canada, the 2022 federal budget announced details of a refundable Investment Tax Credit for CCUS projects from 2022 and 2040, at credit rates ranging from 37.5-60% depending on the project segment (these rates will be halved starting in 2031 to encourage industry to move quickly).

Demand-pull measures can also help drive deployment of near zero emission cement. Many of the government policies noted above for steel are also relevant for cement, including the CEM IDDI Green Public Procurement pledge, Germany's call for proposals for a CCfD, France's RE2020 building regulation embodied carbon targets, and the US IRA low-carbon construction material procurement provisions. On the private-sector side, the First Mover's Coalition is launching an initiative for concrete and the Climate Group's ConcreteZero initiative launched in July 2022 with 17 member firms committing to procure 30% low-emission concrete by 2025 and 50% by 2030. Direct private-sector purchase agreements to near zero emission cement are not observed as in the steel sector.

Plastics

Leading producers of plastics include a combination of dedicated chemical producers and oil and gas producers that also produce chemical products. Top producers are headquartered largely in the United States, the Middle East, the European Union and Asia, with a larger diversity of companies involved in producing recycled plastics. Regions with significant oil and gas resources are advantageous for production, as the main determinant of the choice of route to produce a particular chemical product is the availability and, therefore, cost of feedstocks such as naphtha and ethane.

Moving towards near zero emissions plastics involves two aspects. First is increasing recycling and recycled production. Plastics recycling is an area where major efforts are needed to improve collection rates, improve sorting and expand the range of plastics that can be recycled through technology innovation. This contrasts to metals such as steel and aluminium, where although there is certainly some room to expand recycling, recycling rates are already much higher and recycling technologies well-established, resulting in lower potential to increase secondary production. Second is to develop near zero emission methods to produce plastics from virgin materials. Here, CCUS is one of the leading options, as well as direct electrification.

There are considerable efforts ongoing to develop new methods to recycle a broader range of plastics and to reduce downcycling, which occurs when plastics are recycled into a lower grade of plastic. There is a general concentration of efforts in this area in Europe and North America, although producers are developing projects in other regions such as Asia and the Middle East. Companies involved include both the major chemical producers, but also smaller companies and start-ups. There are fewer developments under way to achieve near zero emissions from virgin production, although still some potentially promising efforts. A couple of known small-scale CCUS projects on high-value chemicals plants have been developed in China. Several projects in Europe and the United States are looking into electrifying steam crackers, one of the key units for producing high-value chemicals. The current projects are all at relatively low technology readiness levels, from concept to small pilot, although plants are under way to quickly scale up to demonstration as early as 2023 and commercialisation as early as 2024. Innovation is also continuing on alternative bio-based materials to produce plastics, although concerns about poor biodegradation and the availability and management of bio-resources have slowed the uptake of these technologies.

Table 3.6 Top plastics producers and leading existing or planned projects making progress towards near zero emission plastics production

	Europe	North America	Asia	Rest of World
Top producers (location of headquarters)	<ul style="list-style-type: none"> • BASF • ENI • LyondellBasell Industries • INEOS • Lanxess 	<ul style="list-style-type: none"> • Dow • ExxonMobil • Chevron Phillips • DuPont 	<ul style="list-style-type: none"> • Sinopec • Formosa Plastics • Mitsubishi Chemical • LG Chemical 	<ul style="list-style-type: none"> • SABIC
Producers undertaking projects towards near zero emission production:				
Improved recycling techniques	<ul style="list-style-type: none"> • ENI (member company Versalis) • Neste • LyondellBasell • OMV • Borealis • Plastic Energy • Quantafuel • Fuenix Ecogy Group • Carbios • Mura • Worn Again Technologies 	<ul style="list-style-type: none"> • Agilyx Corporation • INEOS Styrolution • PureCycle • Loop Industries • BP • Eastman 		<ul style="list-style-type: none"> • Licella
CCUS			<ul style="list-style-type: none"> • Yangchang Petroleum • Sinopec 	<ul style="list-style-type: none"> • SABIC
Electrification	<ul style="list-style-type: none"> • BASF • Borealis • BP • LyondellBasell • SABIC • Total • Coolbrook 			

Sources: BizVibe (2020b); Polymer Database (2022); Plastic Ranger (2021).

Government innovation funding has again been important for the research and development projects that are under way. Compared with other bulk materials, creating demand-pull for near zero emission plastics may be more challenging, given that there is a less clear “chunky” category of demand to target such as construction or vehicles, even though plastics are indeed used for some components within those demand segments. Nevertheless, demand creation will be important, and several policies already mentioned could be applicable. For example, Germany’s CCfD proposal could apply to plastics production. Additionally, the First Mover’s Coalition is scheduled to launch its Chemicals commitment at the 27th Conference of the Parties.

Aluminium

The global aluminium industry is somewhat more concentrated than other materials, at least for primary production: the output of the top ten aluminium producers accounts for about half of global primary aluminium production (BizVibe, 2020c; Rusal, 2019). Half of the top producers are in China, while the rest have globally dispersed headquarters, in Eurasia, Australia, North America, the Middle East and Europe. The major role of China in primary aluminium production (nearly 60% of global total) explains the dominance of major producers there. With regard to recycled production, there is quite a large number of smaller, geographically dispersed producers.

Moving towards near zero emissions aluminium production involves three key aspects: 1) improving scrap collection and sorting in order to maximise recycled production; 2) decarbonising direct emissions from aluminium production – of which process emissions from aluminium smelting and fossil fuel combustion emissions from alumina refining are the two largest sources; and 3) decarbonising indirect emissions from electricity used in aluminium smelting. The industry often places considerable emphasis on the last component – decarbonising power inputs – since these emissions account for a large portion of emissions – about 70% of total (direct and indirect) aluminium production emissions globally. Zero-emission electricity generation technologies are already commercially available, often at competitive costs, although technical, economic and logistical challenges remain related to operating aluminium smelting with variable renewable electricity, given that conventional smelters cannot easily adapt to fluctuating power inputs. Addressing direct emissions will be even more challenging, given that technologies for full decarbonisation are not yet market ready. Thus, a greater emphasis on also tackling direct emissions is needed.

Inert anodes are currently the technology at a more advanced stage of development within those that could eliminate process emissions from aluminium smelting. Yet efforts in this area are relatively concentrated in a few key demonstration and pilot projects: Elysis in Canada (a collaboration between Alcoa and Rio Tinto), Rusal's developments in the Russian Federation, and a collaboration between TRIMET and Arctus Aluminium in Europe. The first two are targeting commercialisation by 2024. Other technologies to reduce aluminium smelting process emissions are at much earlier stages of development, including CCUS (concept state) and chloride electrolysis (lab-scale testing). Besides the inert anode pilot and demonstration projects and their plans for technology commercialisation, there are no major concrete announcements on plans for technology deployment. This compares with about 7 Mt of aluminium production from innovative routes by 2030 in the NZE Scenario.

Table 3.7 Top aluminium producers and leading existing or planned projects making progress towards near zero emission aluminium production

	Europe	North America	Asia	Rest of world
Top producers (location of headquarters)	<ul style="list-style-type: none"> Norsk Hydro 	<ul style="list-style-type: none"> Alcoa 	<ul style="list-style-type: none"> Chalco Hongqiao Xinfa East Hope Group Company China Power Investment Corp 	<ul style="list-style-type: none"> Rusal Rio Tinto Alcan Emirates Global Aluminium
Producers undertaking projects towards near zero emission production:				
Inert anodes	<ul style="list-style-type: none"> TRIMET Arctus Aluminium 	<ul style="list-style-type: none"> Alcoa RioTinto 		<ul style="list-style-type: none"> Rusal
CCUS	<ul style="list-style-type: none"> Alvance Norsk Hydro 			<ul style="list-style-type: none"> Alba
Chloride electrolysis	<ul style="list-style-type: none"> Norsk Hydro 			
Zero-emission fuels for alumina refining				<ul style="list-style-type: none"> Alcoa Rio Tinto South32 Hydro

Sources: Company, government and non-governmental organisation announcements; BizVibe (2020c).

Decarbonising alumina refining centres largely around switching to low-emission fuels, including bioenergy, solar thermal, electricity and hydrogen. Initial steps are already being taken in this regard. In 2022, an electric boiler was installed at the Hydro Alunorte alumina plant in Brazil to provide a portion of the plant's steam demand; two additional electric boilers are planned by 2024. Several other projects are taking place at small pilot stage in Australia, the second-largest alumina-producing country (China is the largest) with about 15% of global production.

Developments are also under way to increase the flexibility of aluminium smelting so that it can more easily support integration of variable renewable electricity sources. EnPot successfully tested the first full industrial-scale installation of its "virtual battery" flexible heat management technology for aluminium smelters in Germany in 2019, and is now working towards commercial roll-out.

As with steel and cement, the geographical dispersion of efforts to develop near zero emission technologies for aluminium production is stark. Despite the current concentration of production in China, and expected future growth in Asia more broadly, there are no known R&D projects under way in Asia to address direct emissions. While efforts there have been more focused on addressing indirect emissions from electricity generation, given the region's high reliance on fossil

fuel-based electricity for aluminium production, it will also be important to address direct emissions in order to reach net zero emissions.

As with the other materials, government funding has been critical to most of the ongoing projects to develop technologies to reduce aluminium's direct emissions. Private-sector investment has also played a role in some cases. For example, Apple has invested in the Elysis, and has also agreed to provide the project with technical support.

While there are several government policies in specific countries that could help create demand pull for near zero emission aluminium, at the moment there is greater momentum in the private sector towards creating demand. Aluminium is part of the First Mover's Coalition, with aluminium purchasers setting a target of at least 10% of their annual primary aluminium procurement volumes being low-CO₂ primary aluminium. Additionally, multiple vehicle manufacturers have set targets to reduce their life-cycle or Scope 3 emissions. Given that a substantial portion of aluminium is used in vehicles, and use is expected to continue increasing in future due to lightweighting, such targets could help drive demand for low-emission aluminium. The private sector is already developing markets and product lines to offer low-emission aluminium at a premium. For example, multiple aluminium companies have launched new, lower-emission product lines (e.g. Alcoa's Sustana line and Rio Tinto's RenewAl products), while the market intelligence agency HARBOR Aluminium launched a "green" primary aluminium sport premium in 2019. While these efforts are likely at the moment to mostly offer the premium for aluminium produced with renewable electricity, over time they could evolve to more stringent requirements and thus help drive demand for aluminium also with near zero direct emissions.

References

- Adamas Intelligence (2020), Rare earth magnet market outlook to 2030.
- Agora Energiewende (2021), Global Steel Transformation Tracker, <https://www.agora-energiewende.de/en/service/global-steel-transformation-tracker/>
- ArcelorMittal (2022a), ArcelorMittal's decarbonisation plan for Spain moves forward with government commitment to funding, <https://corporate.arcelormittal.com/media/news-articles/arcelormittal-s-decarbonisation-plan-for-spain-moves-forward-with-government-commitment-to-funding>
- ArcelorMittal (2022b), ArcelorMittal accelerates its decarbonisation with a €1.7 billion investment programme in France, supported by the French Government, <https://corporate.arcelormittal.com/media/press-releases/arcelormittal-accelerates-its-decarbonisation-with-a-1-7-billion-investment-programme-in-france-supported-by-the-french-government>
- ArcelorMittal (2021a), ArcelorMittal signs letter of intent with the governments of Belgium and Flanders, supporting €1.1 billion investment in decarbonisation technologies at its flagship Gent plant, <https://corporate.arcelormittal.com/media/press-releases/arcelormittal-signs-letter-of-intent-with-the-governments-of-belgium-and-flanders-supporting-1-1-billion-investment-in-decarbonisation-technologies-at-its-flagship-gent-plant>
- ArcelorMittal (2021b), ArcelorMittal and the Government of Canada announce investment of CAD\$1.765 billion in decarbonisation technologies in Canada, <https://corporate.arcelormittal.com/media/press-releases/arcelormittal-and-the-government-of-canada-announce-investment-of-cad-1-765-billion-in-decarbonization-technologies-in-canada>
- Argonne Laboratory (2022), GREET Model, <https://greet.es.anl.gov/>
- Astoria, T., Hughes, G. & Mizutani, N. (2022), Midrex NG with H₂ Addition: Moving from natural gas to hydrogen in decarbonizing ironmaking, <https://www.midrex.com/tech-article/moving-from-natural-gas-to-hydrogen-in-decarbonizing-ironmaking/>
- Australia, Department of Industry, Science, Energy and Resources (2022), 2022 Critical Minerals Strategy, https://www.industry.gov.au/sites/default/files/2022-09/2022-critical-minerals-strategy_0.pdf
- Australian Government (2021), Supporting Australian critical minerals projects, Export Finance Australia, <https://www.exportfinance.gov.au/media/khhkysm3/4-3709-export-critical-minerals-final.pdf>
- Ballard (2018), Benefits of fuel cells: Refurbishing leads to zero-waste, <https://blog.ballard.com/benefits-of-fuel-cells>
- Bartholomeusz, S. (2022), The world has a big problem in the drive to net zero, The Age, 24 October, <https://www.theage.com.au/business/markets/the-world-has-a-big-problem-in-the-drive-to-net-zero-20221024-p5bs8w.html>
- BGR Group (2022), Infrastructure Investment and Jobs Act – power and energy, <https://bgrdc.com/infrastructure-investment-and-jobs-act-power-and-energy>
- Bianchi, W., & Morland, S. (2022), Argentine state-run miners launch first-time lithium project, Reuters, 27 September, <https://www.reuters.com/markets/commodities/argentine-state-run-miners-launch-first-time-lithium-project-2022-09-26/>

- Biden, J.R. (2022), Memorandum on Presidential Determination Pursuant to Section 303 of the Defense Production Act of 1950, as amended, <https://www.whitehouse.gov/briefing-room/presidential-actions/2022/03/31/memorandum-on-presidential-determination-pursuant-to-section-303-of-the-defense-production-act-of-1950-as-amended/>
- BizVibe (2020a), Top 10 cement companies in the world 2020: Global cement industry factsheet, <https://blog.bizvibe.com/blog/top-10-cement-companies-world>
- BizVibe (2020b), Top 10 largest chemical companies in the world 2020, top chemical companies: Chemical industry factsheet, <https://blog.bizvibe.com/blog/largest-chemical-companies#:~:text=Top%2010%20Largest%20Chemical%20Companies%20in%20the%20World,...%208%208.%20LyondellBasell%20Industries%20...%20%C3%89%C3%A9ments%20suppl%C3%A9mentaires>
- BizVibe (2020c), Global aluminium industry factsheet 2020: Top 10 largest aluminium companies in the world, <https://blog.bizvibe.com/blog/top-10-largest-aluminium-companies>
- BKMP (Indonesia, Ministry of Investment) (2021), Indonesia battery cell industry – electric vehicle battery cell factory in Indonesia, <https://www2.bkpm.go.id/en/publication/detail/news/indonesia-battery-cell-industry-electric-vehicle-battery-cell-factory>
- BNEF (BloombergNEF) (2022), 1H 2022 Battery Metals Outlook: Supply Turbulence Ahead.
- BNEF (2020a), Global Nickel Outlook 2020-2030.
- BNEF (2020b), Miners begin cleaning up their act with renewables, <https://about.bnef.com/blog/miners-begin-cleaning-up-with-renewables/>
- Boer, L., Pescatori, A., & Stuermer, M. (2021), Energy transition metals, IMF Working Paper: <https://www.imf.org/en/Publications/WP/Issues/2021/10/12/Energy-Transition-Metals-465899>
- Brevik, (2022), Brevik CCS, <https://www.brevikccs.com/en>
- Canada Nickel (2022), Canada Nickel announces improvements to accelerated CO₂ capture process, <https://canadanickel.com/wp-content/uploads/2022/11/221107-In-Process-Carbonation-Update-vFinal.pdf>
- Chen, A. (2022), The world's first hydrogen-powered haul truck could help clean up the mining industry, CNN, 6 October, <https://edition.cnn.com/2022/10/06/world/hydrogen-mining-truck-first-mode-anglo-american-climate-spc-intl/index.html>
- Christina, B. & Suroyo, G. (2022), S. Korea's LG Energy Solution launches nickel processing plants in Indonesia, Reuters, 8 June, <https://www.reuters.com/breakingviews/skoreas-lg-energy-solution-launches-nickel-processing-plants-indonesia-2022-06-08/>
- Cochilco (Chilean Copper Commission) (2021), Yearbook: Copper and other mineral statistics, <https://www.cochilco.cl/Paginas/Estadisticas/Publicaciones/Anuario.aspx>
- De Beers (2022), CarbonVault, <https://www.debeersgroup.com/sustainability-and-ethics/protecting-the-natural-world/carbon-vault>
- Dry, M., Vaughan, J., & Hawker, W. (2019), Environmental evaluation of making nickel sulphate, presented at Alta 2019 Nickel-Cobalt-Copper, Perth, Australia, May 2019, <http://www.arithmetek.com/publications/Environmental%20Evaluation%20of%20Making%20Nickel%20Sulphate.pdf>
- EIT (European Institute of Innovation & Technology) (2022), EIT RawMaterials, <https://eit.europa.eu/our-communities/eit-rawmaterials>

- Elysis (n.d.), FAQ, Elysis Web site, <https://www.elysis.com/en/faq>
- Emissions Reduction Alberta (2020), Lehigh Cement Edmonton CCUS feasibility project, <https://www.eralberta.ca/projects/details/lehigh-cement-edmonton-ccus-feasibility-project/>
- EPRS (European Parliamentary Research Service) (2021), Critical raw materials in EU external policies: Improving access and raising global standards, [https://www.europarl.europa.eu/RegData/etudes/BRIE/2021/690606/EPRS_BRI\(2021\)690606_EN.pdf](https://www.europarl.europa.eu/RegData/etudes/BRIE/2021/690606/EPRS_BRI(2021)690606_EN.pdf)
- Eurometaux (2022), Metals for Clean Energy: Pathways to Solving Europe's Raw Materials Challenge, <https://eurometaux.eu/media/jmxf2qm0/metals-for-clean-energy.pdf>
- European Commission (2022a), Communication from the Commission to the European Parliament, the Council, the European economic and social Committee and the Committee of the Regions, <https://eur-lex.europa.eu/legal-content/EN/TXT/?uri=COM%3A2022%3A240%3AFIN&qid=1653033053936>
- European Commission (2022b), Critical Raw Materials Act: securing the new gas & oil at the heart of our economy | Blog of Commissioner Thierry Breton, https://ec.europa.eu/commission/presscorner/detail/en/STATEMENT_22_5523
- European Commission (2022c), Third call for large-scale projects, https://climate.ec.europa.eu/eu-action/funding-climate-action/innovation-fund/large-scale-calls_en
- European Commission (2020), Study on the EU's list of Critical Raw Materials (2020), Factsheets on Critical Raw Materials, https://echo-circulaire.com/wp-content/uploads/2020/09/CRM_2020_Factsheets_critical_Final.pdf
- Evans, M.H. (2022), Aurubis tests ammonia for low-carbon copper product output, Reuters, 21 October, <https://www.reuters.com/markets/commodities/aurubis-tests-ammonia-low-carbon-copper-product-output-2022-10-21/>
- Fraser, J., Anderson, J., Lazuen, J., Lu, Y., Heathman, O., Brewster, N., Bedder, J. and Masson, O. (2021), Study on future demand and supply security of nickel for electric vehicle batteries, Roskill, <https://publications.jrc.ec.europa.eu/repository/handle/JRC123439>
- Gleeson, D. (2022), Shell Consortium previews Charge On haul truck electrification solution. International Mining, <https://im-mining.com/2022/10/12/shell-consortium-previews-charge-on-haul-truck-electrification-solution/>
- Goldwind (2022), Goldwind recycles turbine blades into 3D printing materials, <https://www.goldwind.com/en/news/focus-article/?id=737300515733524480>
- Grageda, M., et al. (2020), Analysis of a process for producing battery grade lithium hydroxide by membrane electrodialysis, Membranes, Vol. 10/9, pp. 198, <https://www.mdpi.com/2077-0375/10/9/198>
- H2 Green Steel (2022), H2 Green Steel completes €260 million equity financing to build world's first large scale green steel plant, H2 Green Steel, <https://www.h2greensteel.com/latestnews/h2-green-steel-completes-260-million-equity-financing-to-build-worlds-first-large-scale-green-steel-plant>
- Harper, G., et al. (2019), Recycling lithium-ion batteries from electric vehicles, Nature, Vol. 575, pp. 75-86, <https://www.nature.com/articles/s41586-019-1682-5>

- Holcim (2020, October 14), LafargeHolcim expands carbon capture projects with government funding from the US and Germany, <https://www.holcim.com/media/media-releases/media-release-carbon-capture-projects-USA-germany>
- Hou-Min Li, et al. (2014), Types and geological characteristics of iron deposits in China, *Journal of Asian Earth Sciences*, Vol. 103, https://www.researchgate.net/publication/274096191_Types_and_geological_characteristics_of_iron_deposits_in_China
- Huber, I. (2021), Indonesia's nickel industrial strategy, CSIS (Center for Strategic and International Studies), <https://www.csis.org/analysis/indonesias-nickel-industrial-strategy>
- HYBRIT (n.d.), A fossil-free development, <https://www.hybritdevelopment.se/en/a-fossil-free-development/>
- IAI (International Aluminium Institute) (2022), Current statistics, <https://international-aluminium.org/>
- IEA (International Energy Agency) (2022a), Global EV Outlook 2022, <https://www.iea.org/reports/global-ev-outlook-2022>
- IEA (2022b), A 10-Point Plan to Reduce the European Union's Reliance on Russian Natural Gas, <https://www.iea.org/reports/a-10-point-plan-to-reduce-the-european-unions-reliance-on-russian-natural-gas>
- IEA (2022c), A 10-Point Plan to Cut Oil Use, <https://www.iea.org/reports/a-10-point-plan-to-cut-oil-use>
- IEA (2022d), Critical Mineral Policy Tracker, <https://www.iea.org/reports/critical-minerals-policy-tracker>
- IEA (2022e), Achieving Net Zero Heavy Industry Sectors in G7 Members, <https://www.iea.org/events/achieving-net-zero-heavy-industry-sectors-in-g7-members>
- IEA (2022f), National Budget 2021 – Advanced plastic recycling, <https://www.iea.org/policies/15055-national-budget-2021-advanced-plastic-recycling>
- IEA (2021), The Role of Critical Minerals in Clean Energy Transitions, <https://iea.blob.core.windows.net/assets/ffd2a83b-8c30-4e9d-980a-52b6d9a86fdc/TheRoleofCriticalMineralsinCleanEnergyTransitions.pdf>
- InfoLink (2022), InfoLink online database, <https://www.infolink-group.com/index/en>
- International Aluminium Institute (2021), Global aluminium cycle, <https://alucycle.international-aluminium.org/public-access/>
- IPCC (Intergovernmental Panel on Climate Change) (2022), Sixth Assessment Report, Mitigation of Climate Change, <https://www.ipcc.ch/report/ar6/wg3/>
- IPCEI (Important Project of Common European Interest) (2022), Raw materials and advanced materials, <https://www.ipcei-batteries.eu/technology-fields/raw-materials-and-advanced-materials>
- Jervois (2020), Idaho Cobalt Operations: Form 43-101F1 Technical Report Feasibility Study, https://jervoisglobal.com/wp-content/uploads/2021/06/190348_Idaho_Cobalt_13112020_NI_43_101_Technical_Report-FILED-r1.pdf
- Kasmaeeyazdi, S., et al. (2021), Copernicus data to boost raw material source management: Illustrations from the RawMatCop programme, *Resources Policy*, Vol. 74, <https://www.sciencedirect.com/science/article/pii/S0301420721003937>

- Kelly, J.C. et al. (2021), Energy, greenhouse gas, and water life cycle analysis of lithium carbonate and lithium hydroxide monohydrate from brine and ore resources and their use in lithium ion battery cathodes and lithium ion batteries, *Resources, Conservation and Recycling*, Vol. 174, <https://www.sciencedirect.com/science/article/pii/S0921344921003712>
- Lafarge (2019), Inventys partners with Total and Lafarge to bring carbon capture program to British Columbia, <https://www.lafarge.ca/en/inventys-partners-total-and-lafarge-bring-carbon-capture-program-british-columbia>
- Le Gleuher, M. (2021), Le sulfate de nickel : un ingrédient clé des batteries Li-ion [Nickel sulfate: a key ingredient in Li-ion batteries], *Minéral Info*, 5 August, <https://www.mineralinfo.fr/fr/ecomine/sulfate-de-nickel-un-ingredient-cle-des-batteries-li-ion>
- Loan Programs Office (2022), Inflation Reduction Act of 2022, <https://www.energy.gov/lpo/inflation-reduction-act-2022>
- McKinsey (2020), Climate risk and decarbonization: What every mining CEO needs to know, <https://www.mckinsey.com/capabilities/sustainability/our-insights/climate-risk-and-decarbonization-what-every-mining-ceo-needs-to-know>
- Metso Outotec (2019), The Outotec lithium hydroxide process – a novel direct leach process for producing battery-grade lithium hydroxide from spodumene, <https://www.mogroup.com/insights/blog/mining-and-metals/the-outotec-lithium-hydroxide-process--a-novel-direct-leach-process-for-producing-battery-grade-lithium-hydroxide-from-spodumene/>
- Mining Technology (2020), Borden Gold Mine, Chapleau, Ontario, Canada, <https://www.mining-technology.com/projects/borden-gold-mine-chapleau-ontario/>
- Mudd, G. (2013), The limits to growth and 'finite' mineral resources: Re-visiting the assumptions and drinking from that half-capacity glass, *International Journal of Sustainable Development*, Vol. 16.
- Nabanidham, R., & Cook-Revell, W. (2022), Australian Government announces 2022 Critical Minerals Strategy, Ashurst, <https://www.ashurst.com/en/news-and-insights/legal-updates/australian-government-announces-2022-critical-minerals-strategy/>
- Nassar, N.T., et al. (2022), Rock-to-metal ratio: A foundational metric for understanding mine wastes, *Environmental Science & Technology*, Vol. 56/10, <https://pubs.acs.org/doi/10.1021/acs.est.1c07875>
- Northey, S., et al. (2014), Modelling future copper ore grade decline based on a detailed assessment of copper resources and mining, *Resources, Conservation and Recycling*, Vol. 83, pp. 190-201, <https://www.sciencedirect.com/science/article/pii/S0921344913002127>
- Olafsdottir, A.H., & Sverdrup, H.U. (2021), Modelling global nickel mining, supply, recycling, stocks-in-use and price under different resources and demand assumptions for 1850–2200, *Mining, Metallurgy & Exploration*, Vol. 38, pp. 819-840, <https://link.springer.com/article/10.1007/s42461-020-00370-y#Sec12%20>
- Onstad, E., & Harvey, J. (2021), Boliden launches low-carbon copper products, Reuters, 19 March, <https://www.reuters.com/article/us-copper-boliden-carbon-idUSKBN2BB1C2>
- Plastic Ranger (2021), Top 10 plastic manufacturers in the world, <https://plasticranger.com/top-10-plastics-manufacturers/>

- Polymer Database (2022), Crow's top 10 plastics and resins producers, <https://www.polymerdatabase.com/Polymer%20Brands/Plastic%20Manufacturers.html>
- Prony Resources (2021), TotalEnergies et Prony Resources New Caledonia s'associent pour la transition énergétique du territoire au travers d'un projet solaire de 160 MW [TotalEnergies and Prony Resources New Caledonia join forces for the region's energy transition through a 160 MW solar project], <https://pronyresources.com/fr/media-et-presse/totalenergies-et-prony-resources-new-caledonia-s-associent-pour-la-transition-energetique-du-territoire-au-travers-d-un-projet-solaire-de-160-mw>
- Rötzer, N., & Schmidt, M. (2020), Historical, current, and future energy demand from global copper production and its impact on climate change, Resources, Vol. 9/4, pp. 44, <https://www.mdpi.com/2079-9276/9/4/44/htm>
- Rusal (2019), Crafting A Green Future: Annual Report.
- S&P Capital (2022), Lithium project pipeline insufficient to meet looming major deficit.
- S&P Global (2022a), Industry Monitor November 2022: Overview.
- S&P Global (2022b), Nickel global supply-demand balance, August 2022
- S&P Global (2022c), Iron ore global supply-demand balance, August 2022.
- S&P Global (2022d), Lithium and cobalt global supply-demand balance, January 2022.
- S&P Global (2022e), Copper global supply-demand balance, August 2022.
- Savannah (2019), Barroso Lithium Project, Portugal, <https://www.savannahresources.com/project/barroso-lithium-project-portugal/>
- Setiawan, V.N. (2022), ESDM mau batasi smelter baru nikel berteknologi RKEF, kenapa? [ESDM wants to limit new nickel smelters using RKEF technology, why?], CNBC Indonesia, 22 November, <https://www.cnbcindonesia.com/news/20221122141117-4-390187/esdm-mau-batasi-smelter-baru-nikel-berteknologi-rkef-kenapa>
- Shaw, V. (2022), Chinese PV industry brief: Zhonghuan wants to increase polysilicon capacity by 120,000 Mt., PV Magazine, 8 April, <https://www.pv-magazine.com/2022/04/08/chinese-pv-industry-brief-zhonghuan-wants-to-increase-polysilicon-capacity-by-120000-mt>
- Shaw, V., & Hall, M. (2022a), Chinese PV industry brief: Xinte wants to add another 200,000 tons of polysilicon capacity, PV Magazine, 15 March, <https://www.pv-magazine.com/2022/03/15/chinese-pv-industry-brief-xinte-wants-to-add-another-200000-tons-of-polysilicon-capacity>
- Shaw, V., & Hall, M. (2022b), Chinese PV industry brief: Hoshine plans 200,000 ton poly fab, PV Magazine, 15 February, <https://www.pv-magazine.com/2022/02/15/chinese-pv-industry-brief-hoshine-plans-200000-ton-poly-fab>
- Siemens Gamesa (2022), Revolutionary RecyclableBlades: Siemens Gamesa technology goes full-circle at RWE's Kaskasi offshore wind power project, <https://www.siemensgamesa.com/newsroom/2022/07/080122-siemens-gamesa-press-release-recycle-wind-blade-offshore-kaskasi-germany>
- Sloop, S., et al. (2020), A direct recycling case study from a lithium-ion battery recall, Sustainable Materials and Technologies, Vol. 25, <https://www.sciencedirect.com/science/article/pii/S2214993718300599>

- Sono-tek (2022), Ultrasonic fuel cell catalyst coating systems, https://www.sono-tek.com/industry/alternative-energy-nanomaterials/fuel-cell/?msclkid=42074a1de6211f10e470292f512e51bc&utm_source=bing&utm_medium=cpc&utm_campaign=Fuel%20Cell%20Coating%20Campaign%20MS&utm_term=fuel%20cell%20manufacturer&utm_content=Fuel%2
- Total Materia (2017), The direct nickel process, <https://www.totalmateria.com/page.aspx?ID=CheckArticle&site=ktn&LN=FI&NM=421>
- Trimet (n.d.), Call for tenders: CO₂-freie Aluminiumproduktion – metallic anodes for CO₂-free aluminium, <https://www.trimet.eu/en/trimet/sustainability/environmental-and-climate-protection/production-of-inert-metallic-anodes>
- UNEP (United Nations Environment Programme) (2013), Environmental Risks and Challenges of Anthropogenic Metals Flows and Cycles, https://d396qusza40orc.cloudfront.net/metals/3_Environmental_Challenges_Metals-Full%20Report_36dpi_130923.pdf
- US DOE (United States Department of Energy) (2022), Bipartisan Infrastructure Law: Battery materials processing and battery manufacturing & recycling funding opportunity announcement, <https://www.energy.gov/sites/default/files/2022-11/DOE%20BIL%20Battery%20FOA-2678%20Selectee%20Fact%20Sheets.pdf>
- USGS (United States Geological Survey) (2022), Mineral Commodity Summaries 2022, <https://pubs.er.usgs.gov/publication/mcs2022>
- Vif, J.-Y (2022), Une première mine de lithium va être exploitée en France, avec l'ambition d'équiper 700 000 véhicules en batteries par an [A first lithium mine will be operated in France, with the aim of equipping 700 000 vehicles with batteries per year], Le Monde, 24 October, https://www.lemonde.fr/economie/article/2022/10/24/imerys-annonce-l-ouverture-de-la-premiere-production-de-lithium-en-france-qui-fera-de-l-entreprise-un-acteur-de-poids-du-marche-europeen_6147060_3234.html
- Vulcan (2022), Zero carbon lithium, <https://v-er.eu/zero-carbon-lithium/>
- Warren Centre (2020), Zero Emission Copper Mine of the Future, <https://copperalliance.org/wp-content/uploads/2020/07/Emissions-Copper-Mine-of-the-Future-Report.pdf>
- WBMS (World Bureau of Metal Statistics) (2022), World Metal Statistics Yearbook.
- White House (2022), Fact sheet: Securing a Made in America supply chain for critical minerals, <https://www.whitehouse.gov/briefing-room/statements-releases/2022/02/22/fact-sheet-securing-a-made-in-america-supply-chain-for-critical-minerals/>
- WindEurope (2020), Accelerating wind turbine blade circularity, <https://windeurope.org/intelligence-platform/product/accelerating-wind-turbine-blade-circularity/>
- World Steel Association (2022), 2021 top steel-producing companies, <https://worldsteel.org/steel-topics/statistics/top-producers/>
- Zavahir, S., et al. (2021), A review on lithium recovery using electrochemical capturing systems, Desalination, Vol. 500, <https://www.sciencedirect.com/science/article/pii/S0011916420315617>

Chapter 4. Technology manufacturing and installation

Highlights

- Today's announced plans to manufacture solar photovoltaic (PV) modules, if fully realised, would be sufficient to meet 2030 demand levels in the Net Zero by 2050 (NZE) Scenario. These expansion plans fall short for other clean energy technologies, but short project lead times of one to three years – combined with further recently announced policy incentives – suggest that the gaps are not insurmountable. Investment of USD 640 billion by 2030 is needed to expand global production of mass-manufactured technologies in line with the NZE Scenario; announced projects would be equivalent to around two-thirds of this investment.
- Announced EV battery manufacturing projects, mostly in China, could boost production capacity sixfold by 2030 and meet over 80% of the needs in the NZE Scenario. Project announcements suggest that manufacturing of wind components would only grow by 5-10% (onshore) and 20-55% (offshore) by 2030, compared with a quadrupling of wind turbine deployment in the NZE Scenario. Electrolyser manufacturing capacity would rise almost tenfold from today's level to more than 100 gigawatt (GW) by 2030, around half of NZE Scenario requirements. Announced heat pump manufacturing projects could meet a third of NZE Scenario needs for 2030, with an equivalent figure of half for fuel cell trucks.
- The timely rollout of large-scale, site-tailored technologies is uncertain. For example, current deployment plans are equivalent to only about 15% of NZE Scenario needs in 2030 for low-emission synthetic hydrocarbon fuels, and 20% of demand for bioenergy with carbon capture. These technologies are at early stage of development and typically involve long project lead times.
- The workforce to install and manufacture clean energy technologies needs to grow substantially. Today, around 33 million people are working in clean energy. By 2030, in the NZE Scenario, an additional 8 million workers will be needed to manufacture electric vehicles and their batteries, though there is a possibility for workers currently involved in manufacturing internal combustion engine (ICE) vehicles to work in the majority of these roles. An additional 4 million workers will be needed to install (75%) and manufacture (25%) solar PV, wind and heat pump systems.
- Supportive industrial policies, access to low-cost energy and materials, availability of workers and trade policies largely explain China's globally dominant manufacturing base. Other countries are working to expand their clean energy manufacturing capacity: notable recent policy efforts include the US Inflation Reduction Act, the REPowerEU plan, Japan's Green Transformation initiative and India's Production Linked Incentive scheme. However, on the basis of current expansion plants, today's level of geographical concentration appears set to remain high throughout the present decade.

Overview

The Net Zero Emissions by 2050 (NZE) Scenario's clean energy trajectory involves massive clean energy technology deployment, which hinges on the parallel expansion of manufacturing and installation capacity. We therefore assess prospects for these clean technology supply chain stages in this chapter, focusing on the expansion of manufacturing and installation capacity based on current and announced construction activity²⁷. We distinguish between two broad technology categories:

Mass-manufactured technologies, which are assembled in specialised factories in large volumes using several manufactured components and sub-assemblies, with the ready-to-use end product exiting the factory floor. Of the selected supply chains analysed in this report, solar PV modules, wind turbines, electric cars, fuel cell trucks, heat pumps and electrolyzers are key technologies that fall into this category.

Large-scale, site-tailored technologies, which are usually individually designed and manufactured to fit specific local conditions. They may consist of a number of components that themselves are mass manufactured, but their engineering, assembly and installation are site-specific. Of the supply chains analysed in this report, natural gas-based hydrogen with carbon capture and storage (CCS), direct air capture (DAC), bioenergy with carbon capture (BECC), and low-emission synthetic hydrocarbon fuels are included in this category.

This chapter assesses the lead times involved in technology manufacturing and installation and identifies gaps in meeting NZE Scenario demand in 2030, according to current capacity expansion plans for the specific supply chains reviewed in this report. Lead times are based on historical values, though they may decrease in upcoming years as supply chains mature and local permitting procedures improve. The scope for reducing lead times is particularly important for the installation of site-tailored technologies, some of which are at a very early stage of deployment, with future projects almost certainly taking much less time to complete as industry experience grows.

Announced projects for expanding capacity or building new facilities include projects that are at different stages of development, with some already under construction and others not yet at the final investment decision stage. However, they should not be taken as a production forecast. While capacity additions could turn out to be higher than current public announcements (this is especially the case for mass-manufactured technologies, which tend to be announced just

²⁷ Based on announcements up to November 2022.

before construction begins), not all announced projects will materialise. How these factors play out will vary by technology. Nevertheless, our assessment provides an indication of which technologies are most likely to be subject to supply shortfalls.

Our analysis suggests that component and technology manufacturing is not likely to represent a major bottleneck in clean energy supply chains in the short to medium term (Figure 4.1). Prospects for installing systems are less certain, particularly for large-scale, site-tailored technologies, which typically involve longer lead times and for which investment announcements point to substantial financing shortfalls. Those shortfalls are most significant for low-emission synthetic hydrocarbon fuel production and BECC (Figure 4.2). Announcements for site-tailored technologies are often made prior to or during front-end engineering and design (FEED) work or at the final investment decision stage, so major expansion plans would need to be formalised in the next few years for deployment to accelerate as quickly as projected in the NZE Scenario.

Figure 4.1 Current global manufacturing capacity, announced capacity additions, capacity shortfall in 2030 relative to the NZE Scenario, and lead times for selected mass-manufactured clean energy technologies and components

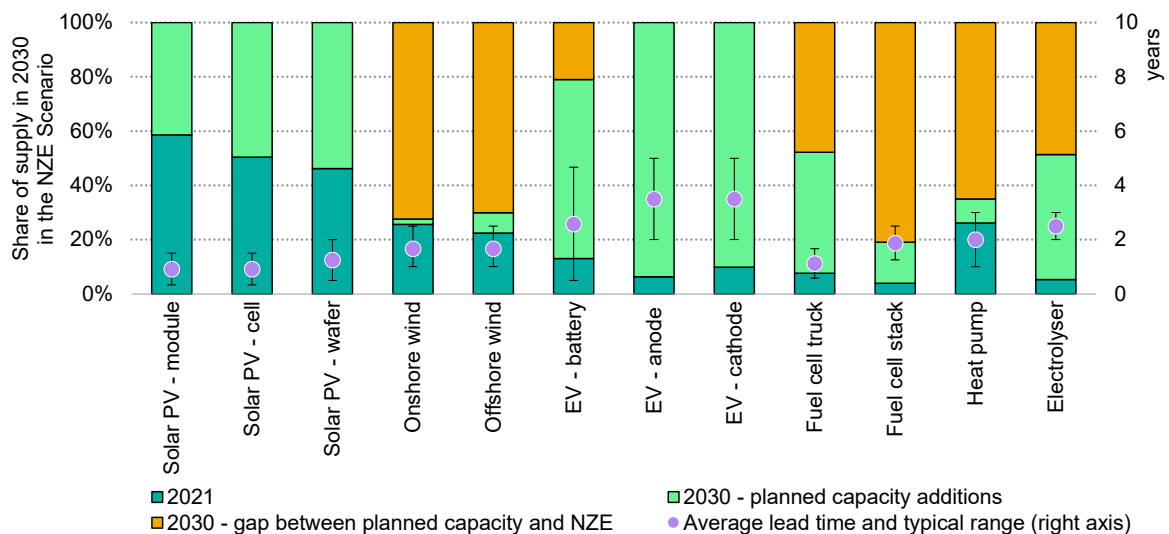

IEA. CC BY 4.0.

Notes: NZE = Net Zero Emissions by 2050 Scenario; PV = photovoltaics; EV = electric vehicle. Announced capacity additions take account of projects to expand or build new facilities that have already reached the final investment decision stage and that are under construction or about to begin construction, as well as those awaiting such a decision. Lead time refers to bringing online new manufacturing capacity.

Announced manufacturing expansions and lead times imply that for mass-manufactured technologies there is still time to address shortfalls in manufacturing capacity.

Figure 4.2 Current global capacity, announced capacity additions, capacity shortfall in 2030 relative to the NZE Scenario, and installation lead times for selected large-scale, site-tailored clean energy technologies

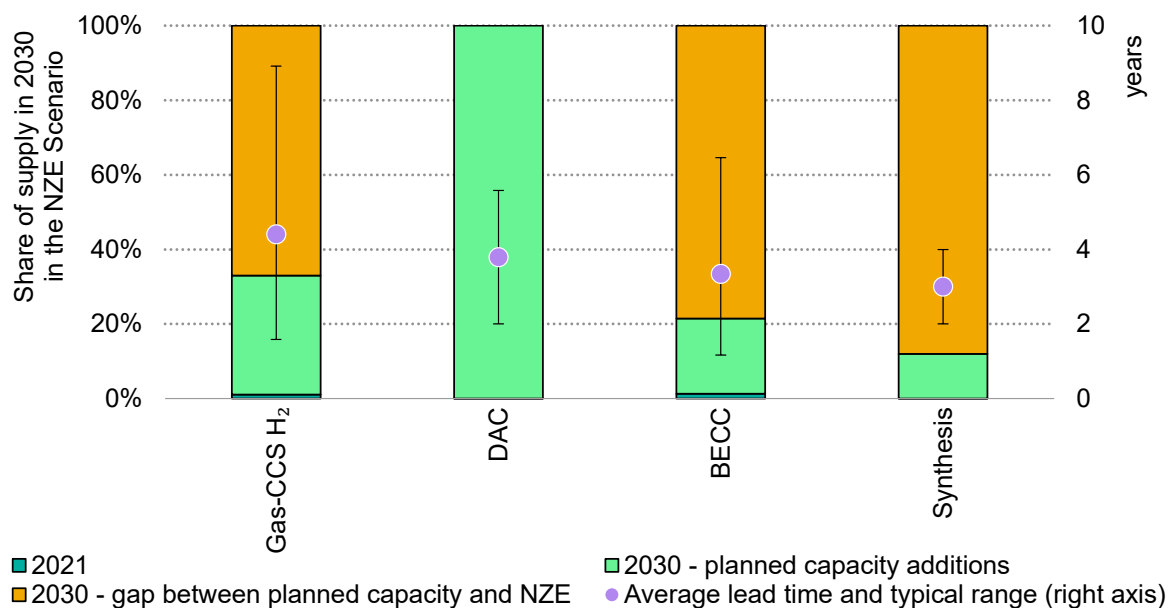

IEA. CC BY 4.0.

Notes: NZE = Net Zero Emissions by 2050 Scenario; DAC = direct air capture; BECC = bioenergy with carbon capture; Gas-CCS H₂ = natural gas-based hydrogen with carbon capture and storage. "Synthesis" refers to low-emission synthetic hydrocarbon fuels. Announced capacity additions take account of projects to expand or build new facilities that have already reached the final investment decision stage and that are under construction or about to begin construction, as well as those awaiting such a decision but that are expected to proceed.

For large-scale, site-tailored technologies, the average lead time between the first feasibility studies and plant commissioning is up to five years.

A major workforce expansion will be needed in upcoming years to manufacture and install these clean energy technologies. Over 8 million jobs manufacturing EVs and their batteries will need to be filled globally by 2030 in the NZE Scenario, though 7 million of those can probably be met through a shift in the workforce from ICE vehicle manufacturing. For solar PV, wind and heat pump systems, the number of additional workers needed to install the technologies will outnumber those required to manufacture them around two-to-one. Thus, the installer workforce grows substantially for each of these segments in the NZE Scenario by 2030: one million additional workers are needed globally to install solar PV panels, another million to install wind turbines and around 800 000 to install heat pumps (Figure 4.3).

The number of solar PV installers expands the most, as the share of labour-related project costs remains much larger than for the other technologies. The need for heat pump installers rises most sharply – nearly fivefold by 2030 – but much of this demand could be met by construction workers who today install other heating and air conditioning equipment. Increasing the number of wind system installers will be more challenging, as many of the new positions require higher-level skills

and more stringent credentials to handle specialised transport and construction equipment as well as additional safety considerations, especially in the offshore context.

Figure 4.3 Global employment in manufacturing and installing selected mass-manufactured clean energy technologies in the NZE Scenario, 2019 and 2030

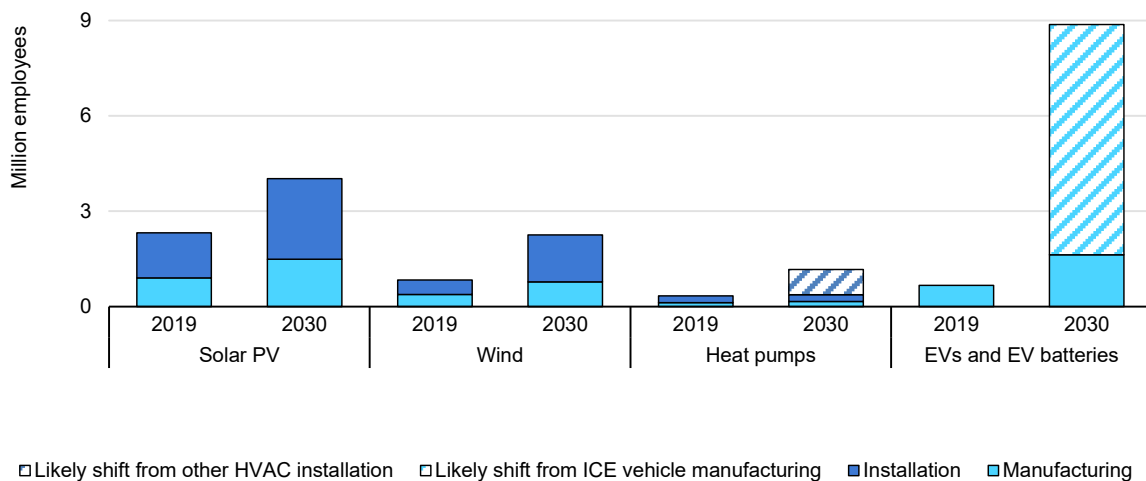

IEA. CC BY 4.0.

Notes: PV = photovoltaics; EV = electric vehicle; ICE = internal combustion engine; HVAC = heating, ventilation and air conditioning.

Source: IEA (2022a).

The NZE Scenario requires a major workforce expansion to manufacture and install clean energy technologies, particularly to install solar PV and wind systems.

A lack of skilled workers may hinder the deployment of clean energy technologies in upcoming years. A shortage of wind turbine and heat pump installers has already emerged in major markets such as Europe, the United States and Australia, with over 98% of US employers in wind turbine construction reporting hiring difficulties in 2022 (United States, DOE, 2022e) (IEA, 2022b). Within the European Union, 19 member countries and regions are reporting shortages in key occupations most relevant to heat pump installation. China is struggling to recruit workers in manufacturing, with labour shortages expected to swell to nearly 30 million employees by 2025 (see Chapter 1). In addition, technology installation can require specialised equipment as well as labour, which could pose potential bottlenecks (see Box 4.1).

Box 4.1 Potential installation bottlenecks in the wind sector

Installing a wind turbine requires fewer workers per unit of capacity than solar PV, but more material inputs, notably cement and cabling, as well as specialised machinery to transport and position the turbine. In the case of offshore wind farms, specialised vessels are required, which increasingly need to be capable of handling taller and larger wind turbines. There are concerns that a shortage of such vessels could lead to delays in completing new projects.

Outside of China, there are currently around ten vessels that can be used to build offshore wind farms, each with an ability to install roughly 0.5-0.7 GW of capacity per year (Wind Europe, 2022). New vessels are under construction and others are planned, which should boost the fleet to at least 25 vessels by 2026. It is expected that the new vessels will be designed to handle larger turbines, reaching roughly 1.3 GW per vessel per year by 2030, making the construction process more efficient. As a result, current plans point to installation capacity increasing fivefold by the end of the decade to well over 30 GW per year. But in the NZE Scenario, installations of offshore wind, excluding China, exceed 65 GW in 2030, requiring a total of over 50 vessels. To avoid bottlenecks, the current rate of wind turbine installation vessel construction would need to be maintained through to 2030.

Building up a trained workforce to install a new technology takes time, so proactive and strategic labour planning is needed to prevent shortages. Established experience with similar technologies already in use can be leveraged to reduce the time and effort needed to training clean energy manufacturers and installers. For example, vehicle assembly line workers can be shifted to production lines for electric vehicles and boiler installers could be redeployed to install heat pumps. Although shifting these workers does require additional training, much of it can be done on the job or through short training courses. For example, while it could take up to four years for someone without previous experience in heating and cooling installation to become a certified heat pump installer (depending on the level of qualification), workers with previous experience installing heating systems could be trained in just a few weeks.

Workforce requirements also depend on the length of the installation process, which varies by technology type and size. For instance, installing an offshore wind farm takes six or more years. For large-scale solar PV farms, installers can spend 8-14 months on a project, while distributed rooftop PV systems can typically be installed in just a few days. Meanwhile, installing or replacing a boiler with a heat pump in a building also normally takes only a few days, though this is still longer than the time needed to simply replace a fossil fuel-fired boiler with another one. Small-scale, short-duration projects typically rely on a less specialised workforce,

which may work only part-time on clean energy projects such as rooftop solar PV and heat pumps. Standardised credentials or accreditations can help ensure that workers have the requisite training for such projects, whereas long-duration projects can rely more on on-the-job training.

Site-tailored systems such as gas-based hydrogen production with CCS, BECC, DAC and synfuel production also require a trained workforce to manufacture equipment and build and operate the plant. The workforce requirement is highest during the construction phase. For example, it is estimated that the 8 Mt CO₂/year BECCS project at Drax power plant in the United Kingdom could require as many as 4 000 full-time equivalents per year during the four-year construction phase. Like most energy assets, operating the facility will require far fewer workers: only around 375 people will be needed to operate the plant and its transport and storage infrastructure (Drax, 2021a). Retrofitting existing plants with carbon capture is also a way to retain employment in a region, and announced operational jobs are often a combination of both new and retained jobs.

The total workforce requirement for site-specific clean energy installations is much lower than for mass-manufactured technologies. The additional workforce requirement for both the construction and operation of gas-based hydrogen production with CCS, DAC, BECC, and low-emission synthetic hydrocarbon fuel production plants could reach 150 000 to 300 000 by 2030 in the NZE Scenario, depending on plant scale and whether projects are retrofits or new builds. Many of these installations will rely on construction and processing equipment used already in the thermal power generation, natural gas processing and chemical production sectors, and could draw upon the existing pool of skilled workers in these areas. However, this would not safeguard these projects from the broader construction and manufacturing labour shortages present in many economies.

Mass manufacturing of clean technologies and components

For mass-manufactured clean energy technologies, bottlenecks resulting from gaps between announced manufacturing capacity expansion and projected production in 2030 in the NZE Scenario are less of a concern than for steps higher in the supply chain. The main reason is that lead times for bringing new manufacturing capacity on line are relatively short, averaging one to four years (see Chapter 1), so there is still time to fill any current shortfalls in manufacturing capacity. However, it remains uncertain just how many current plans will actually proceed, as investment decisions can change with fluctuations in demand, policy support and costs. These uncertainties are typically more acute in emerging economies due to higher financing costs.

For some technologies, manufacturers are currently operating well below full capacity, as many investments were made in anticipation of higher demand, to allow plants to operate flexibly and respond quickly to short-term demand variations. For example, battery factories were operating at just under 40% of their nameplate capacity on average worldwide in 2021, and the capacity utilisation rate for solar PV modules was around 40%. Utilisation rates are generally lower in China. In the short term, there is a lower risk of bottlenecks in manufacturing than for other stages of the supply chain. However, this is not the case for all technologies. For example, the utilisation rate at most heat pump factories is closer to 80%, which is broadly in line with standard manufacturing industry practice of allowing enough spare capacity to deal with unplanned maintenance or logistical problems – although significant differences exist across facilities (see Chapter 2).

Under the NZE Scenario, expanding the global manufacturing capacity of the six selected clean energy technologies reviewed in this report – wind, solar PV, EV batteries, electrolysers, heat pumps and fuel cell trucks – will require cumulative investment of around USD 640 billion (in real 2021 US dollars) over 2022-2030 (Figure 4.4). Around two-thirds is needed to scale up EV battery (including anode and cathode) manufacturing and around 15% would be dedicated to wind power. About USD 470 billion already claimed by projects in the pipeline, most of which are in China, Europe and North America. This represents about two-thirds of the cumulative investment required. Shortfalls in investment to 2030 amount to around USD 90 billion for EV batteries, USD 45 billion for fuel cells and fuel cell trucks, and around USD 15 billion for heat pumps.

Scaling up clean energy technology manufacturing capacity is crucial not only to meet higher demand in 2030, but to establish the foundation needed to achieve net zero emissions by 2050. Deployment of most of the mass-manufactured technologies continues to increase after 2030, though more slowly than during the current decade as markets reach saturation. For example, global EV battery sales grow on average by more than 15% per year over 2022-2030, slowing to around 5% during the 2030s and just 1% in the 2040s, when EVs account for almost all car sales. In the case of both electrolysers and solar PV systems, meeting the manufacturing capacity scaleup required during the current decade in the NZE Scenario would be sufficient to also meet demand after 2030, as no additional capacity investment is needed.

Figure 4.4 Announced global cumulative investment in mass manufacturing of selected clean energy technologies by region/country and that required to meet demand in 2030 in the NZE Scenario, 2022-2030

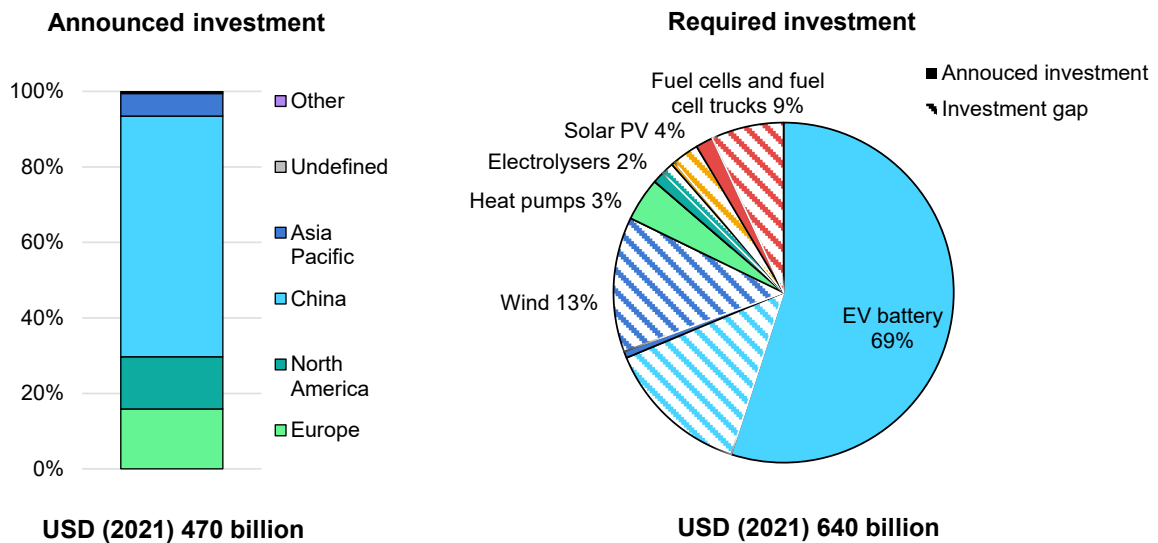

IEA. CC BY 4.0.

Notes: Required investment is that associated with projected deployment to 2030 in the NZE Scenario. EV batteries include anode and cathode manufacturing; solar PV includes module and cell manufacturing.

Expanding mass-manufacturing capacity for clean energy technologies to the NZE Scenario level will require around USD 640 billion of investment over 2022-2030, with 80% allocated to wind systems and EV batteries.

Box 4.2 Carbon intensity of technology manufacturing

Manufacturing, assembling, installing and constructing clean energy technologies tend not to be energy-intensive or carbon-intensive processes. This is because they do not generally involve high temperatures but rather mechanical operations, which use much less energy. The global manufacturing sector falls within the “light industry” category of energy use, which accounts for around 5% of global CO₂ emissions today. For most technologies, electricity is currently the main energy input, accounting for around 35% of total energy consumption in the manufacturing sector in 2021, followed by natural gas at 20%. Given its heavy reliance on electricity, the entire sector halves its emissions from today’s level by 2035 in the NZE Scenario, thanks to the parallel increase in the electrification of manufacturing and the decarbonisation of power generation.

Solar PV

Global solar PV deployment over the last decade or so has been nothing short of spectacular, with installed generation capacity rising to over 1 000 GW by 2022, compared with just 40 GW in 2010. Solar PV generation accounted for 4% of global electricity generation and 14% of total renewable generation in 2022. This momentum is expected to continue for the foreseeable future as policy goals become increasingly ambitious and competitiveness with fossil-based generating technologies improves.

Expansion plans and the gap with the net zero trajectory

The announced expansion plans of solar PV manufacturers are well on track to satisfy projected demand by 2030 in the NZE Scenario. Module manufacturing capacity is already far in excess of current demand with a global average utilisation rate of less than 50% in 2021. Announced expansion plans would raise capacity to around 790 GW by 2027, enough to cover all demand projected for 2030 in the NZE Scenario. The situation for cell manufacturing is almost identical, with announced expansion plans boosting global manufacturing capacity to around 810 GW by 2027 – easily enough to satisfy projected demand in 2030. Wafers are also on track, with a margin similar to that of cells and modules: if all projects are completed on time, manufacturing capacity would reach more than 790 GW by 2027.

Although announced expansions would cover projected NZE Scenario demand to 2030, manufacturing capacity still needs to exceed demand, as it is unrealistic to expect manufacturers to operate continuously at maximum capacity. Even so, assuming an average utilisation rate of 85% in all three manufacturing stages, announced module, cell and wafer capacity expansions would still cover NZE Scenario requirements, with surpluses of 14 GW for modules, 36 GW for cells, and 22 GW for wafers (Figure 4.5).

Most of the major manufacturers of all solar PV supply chain components are in China, which currently supplies more than 70% of the world's modules and an even larger share of subcomponents (see Chapter 2). In the case of wafers, LONGi and Zhonghuan Solar are the largest manufacturers worldwide, covering around 50% of global manufacturing capacity. For solar cells, Tongwei, Aiko, LONGi and Trina combined represent around 40% of global manufacturing capacity. The same trend applies to module manufacturing, with the main manufacturers (LONGi, Trina, Jinko Solar and JA Solar) together constituting approximately 40% of global capacity. According to current expansion plans, the high concentration of manufacturing in China is not expected to decrease in upcoming years, with its share of global manufacturing capacity reaching 78% for modules, 85% for cells and 94% for wafers in 2027.

Figure 4.5 Solar PV manufacturing capacity by country/region according to announced projects and in the NZE Scenario

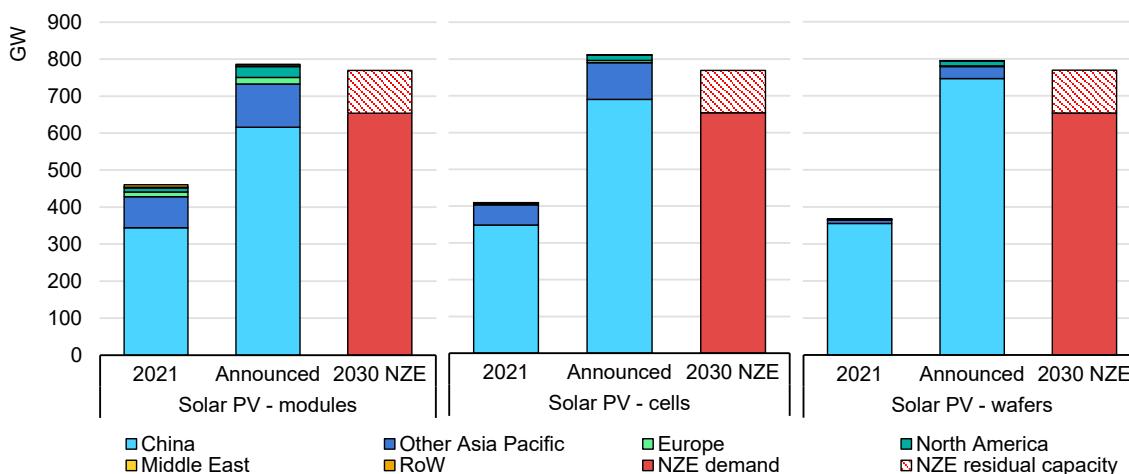

IEA. CC BY 4.0.

Notes: GW = gigawatts; RoW = rest of world; NZE = Net Zero Emissions by 2050 Scenario. Announced capacity includes existing capacity. The manufacturing capacity needed to meet projected demand in the NZE Scenario (NZE demand) is estimated assuming a utilisation rate of 85%. NZE residual capacity, thus, represents the manufacturing capacity that would remain unused, on average, which provides some flexibility to accommodate demand fluctuations.

Announced expansion projects for module, cell and wafer manufacturing, mostly in China, are sufficient to cover the capacity needed by 2030 in the NZE Scenario.

The same companies will also continue to dominate the market in the next few years, as the top five manufacturers globally have plans to at least double their manufacturing capacity of the three key components in the next four years. Together, they account for 42% of global capacity additions for modules, 48% for cells and 57% for wafers to 2026. Module manufacturing is expected to remain the least concentrated step in the supply chain, with the Asia-Pacific region covering around 15% of global manufacturing capacity (117 GW) in 2027.

There have been many expansion announcements in the solar PV supply chain industry in recent years, particularly in 2022, with several multi-billion-dollar investments announced across different steps of the supply chain (Table 4.1). For example, LONGi recently announced investment of USD 2.4 billion to increase its manufacturing capacity for silicon wafers by 20 GW, monocrystalline cells by 30 GW and solar modules by 5 GW in Inner Mongolia (PVTIME, 2022). Canadian Solar announced a record-high investment of USD 9.8 billion in a production base in Qinhai, China, aiming to annually produce 200 000 tonnes of polysilicon, 250 000 tonnes of silicon metal, 50 GW of silicon ingot casting, 10 GW of wafers, 10 GW of cells and 10 GW of modules (Shaw, 2022). Although most of the expansion plans are in China, some major investments have been announced in other regions. One example is Enel’s decision to build a 3-GW-per-year module factory in Sicily, due to come on line by 2024, supported by a grant from the European Union (Enel, 2022).

Table 4.1 Selected announced expansion projects for manufacturing solar PV supply chain components

Manufacturer	Component	Region of announced expansion	Expected completion	Billion USD
Canadian Solar	Modules, cells, silicon, crucibles	Qinghai, China	2027	9.8
LONGi	Wafers, cells and modules	Inner Mongolia, China	2024	2.4
Shangji	Wafers	Jiangsu, China	2024-2025	2
Tongwei	Cells	Sichuan, China	First phase 2023	1.9
Q Cells	Modules	South Carolina, US	2024	1.8
Jiangxi Jinko	Modules and aluminium frames	Jiangxi, China	2023-2025	1.5
Jiangxi Jinko	Monocrystalline silicon pull rods	Qinghai, China	2023-2024	1.4
Solar Space	Cells	Anhui, China	2023	1.4
Eging PV	Modules, cells and wafers	Anhui, China	N/A	1.4
First Solar	Modules	Alabama, United States	2025	1.2
JA Solar	Cells and modules	Jiangsu, China	2023	1

Notes: N/A = not available. Only selected expansion plans announced during 2022 with an investment of over USD 1 billion are listed in the table.

Regional policy and market developments

China's dominance in most of the solar PV supply chain steps is in large part the consequence of strong policy support over the last couple of decades. Since 2001, all the Five-Year Plans (the 10th, 11th, 12th, 13th and 14th) have promoted national solar supply chains through various mechanisms and incentives, considering the solar PV industry an emerging strategic sector. Low labour costs and ample land availability also helped. The 14th Five-Year Plan, released in June 2022, set a target of 33% of electricity generation coming from renewables by 2025, including an 18% target mainly for wind and solar technologies (Sino German Cooperation on Climate Change, 2022). Considering the short lead times of China's solar PV industry and the announced expansion plans in place, these policies to stimulate demand are essentially supporting domestic solar PV manufacturing, as Chinese manufacturers have already shown that they can ramp up their production to match growing demand.

In the **United States**, the Inflation Reduction Act (IRA) enacted in August 2022 aims to – among other goals – lower energy costs, increase energy security, enhance domestic manufacturing of clean technologies and decarbonise all

sectors of the economy. It is expected to mobilise USD 370 billion in energy and climate investments (Everett and Levine, 2022), of which a sizeable amount is expected to flow to the solar PV industry, stimulating demand and securing and strengthening local supply chains (Maryland Clean Energy Center, 2022). The IRA aims to provide ten years of consumer tax credits to make homes more energy-efficient, including through the installation of rooftop solar systems, as well as over USD 60 billion for clean energy manufacturing, including tax credits to accelerate domestic manufacturing of solar panels and up to USD 10 billion to build clean technology manufacturing facilities.

In the **European Union**, the REPowerEU plan released in May 2022 proposes a target of 320 GW of solar PV by 2025 and almost 600 GW by 2030 (European Commission, 2022a). Within this plan, the EU Solar Energy Strategy sets out different initiatives to strengthen the European solar PV supply chain, including the European Solar PV Industry Alliance, which aims to facilitate innovation-led expansion of a solid and resilient solar PV value chain, with particular focus on the manufacturing stage. The strategy seeks to diversify the supply of critical materials, in particular polysilicon, improve resource efficiency and circularity, and achieve manufacturing capacity equivalent to 30 GW of solar PV at each step of the value chain by 2025 (European Commission, 2022c).

In **India**, the Production Linked Incentive (PLI) Scheme under the National Programme on High Efficiency Solar PV Modules was approved in 2022, with the aim of reducing the country's dependence on imports of solar energy technologies and strengthening the domestic solar PV manufacturing ecosystem. The scheme estimates that manufacturing capacity could be increased by around 65 GW in different steps of the solar PV supply chain (India, PM India, 2022). In October 2022, the Ministry of New and Renewable Energy and the Solar Energy Corporation of India launched the second phase of the PLI, with an incentive package of around USD 3 billion to encourage the creation of a complete local ecosystem of integrated solar PV manufacturing from polysilicon, ingot, wafer, cell and module facilities.

Wind power

Like solar PV, wind power deployment has been a great success story. Led chiefly by the construction of onshore wind farms, global deployment of wind turbines worldwide has grown almost twentyfold since 2000, when developers installed only around 5 GW of generation capacity and European companies supplied 90% of the market. Global installed wind generation capacity reached around 830 GW in 2021, providing almost one-quarter of global renewable electricity, surpassed only by hydropower. Thanks to the realisation of economies of scale, technological innovation and strong policy support for clean energy technologies, wind is now

among the most affordable options for new generation capacity all over the world. Chinese manufacturers have provided up to 40% of the equipment used in capacity deployed to date.

Many countries, especially China and most advanced economies, have set ambitious renewables targets for 2030, yet the wind industry is facing several difficulties in expanding manufacturing and installation capacity to exploit these opportunities. Worsening inflationary pressure, fierce competition, high financing costs and long permitting processes are shrinking margins for manufacturers of wind turbines, nacelles (which house the generator, gearbox, drivetrain and brake assembly) and towers. In addition, costs are being pushed up by the need to upgrade manufacturing lines in response to constant technological advances.

Expansion plans and the gap with the net zero trajectory

At present, onshore and offshore wind component manufacturers are expanding capacity more slowly than that required in the NZE Scenario, which calls for global deployment of wind turbines to quadruple between 2021 and 2030, with capacity reaching around 315 GW onshore and around 85 GW offshore. Announced expansion plans would increase onshore blade manufacturing capacity by only 11% to around 110 GW by 2030. In the case of onshore nacelles, manufacturing capacity would grow by around 8% to 108 GW, while that of onshore towers expands by just 5% to 92 GW. The picture is similar for offshore wind components. Manufacturers have announced capacity expansions of 55% for offshore towers, 31% for blades and 21% for nacelles, but these increases are still far below what is needed by 2030 in the NZE Scenario (Figure 4.6).

There is still time to fill this gap: lead times to build new manufacturing capacity range from 15 months to 2 years, and the industry has shown in the past that it can quickly ramp up capacity at times of strong demand. For example, installations surged by around 70% between 2015 and 2020. In addition, current high fossil fuel prices, which are setting high wholesale electricity prices, are providing a strong incentive to invest in many parts of the world, notably Europe. Nonetheless, the considerable gap between current expansion plans and that needed to be on track for the net zero trajectory means that a significant near-term boost in manufacturing investment is needed.

Figure 4.6 Wind power manufacturing capacity by component and country/region according to announced projects and in the NZE Scenario

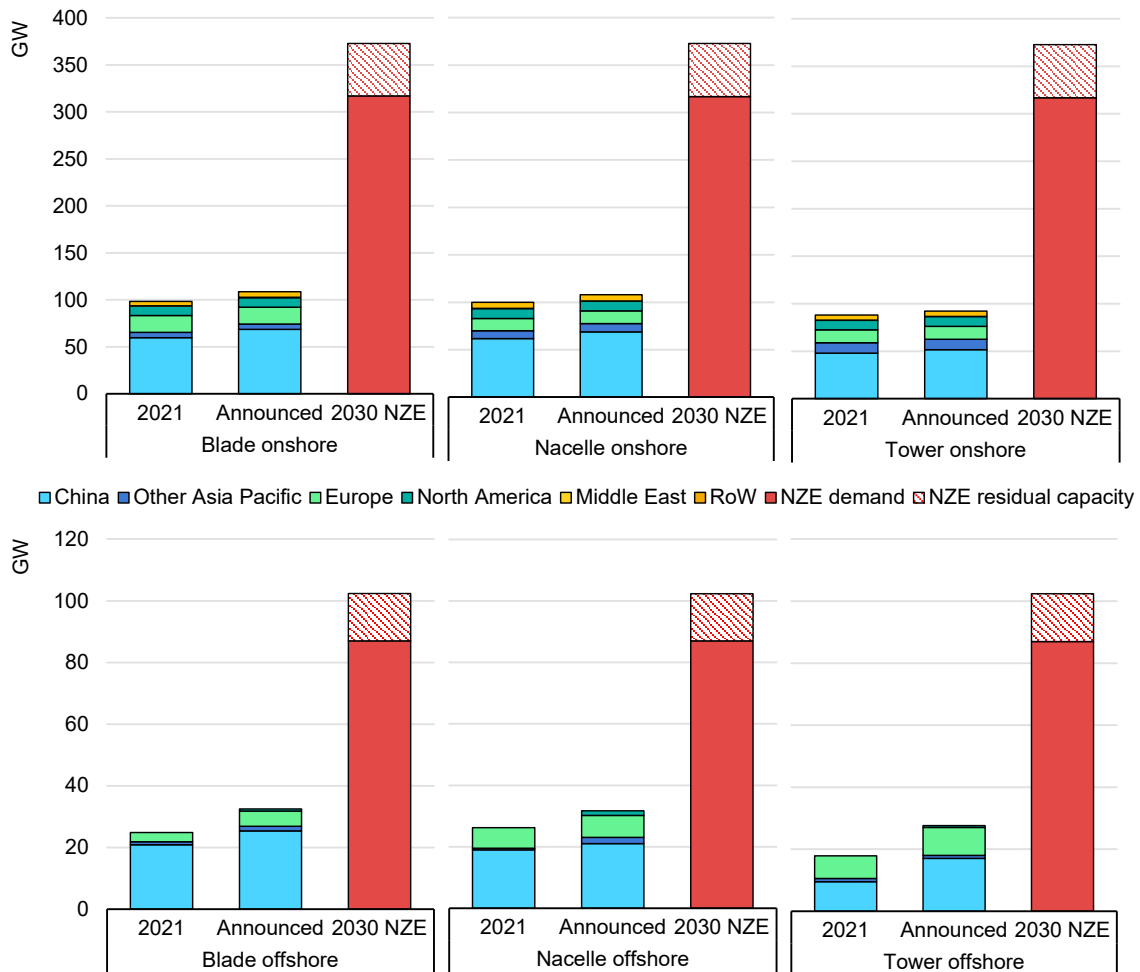

IEA. CC BY 4.0.

Notes: GW = gigawatts; RoW = rest of world; NZE = Net Zero Emissions by 2050 Scenario. Announced capacity includes existing capacity. Minimum facility capacity of 500 MW/year is assumed when capacity data is unavailable. The manufacturing capacity needed to meet projected demand in the NZE Scenario (NZE demand) is estimated assuming a utilisation rate of 85%. NZE residual capacity, thus, represents the manufacturing capacity that would remain unused, on average, which provides some flexibility to accommodate demand fluctuations.

Sources: IEA analysis based on BloombergNEF (2021) and Wood Mackenzie (2022).

Announced expansion projects for both offshore and onshore component manufacturing are far from sufficient to cover the capacity needed by 2030 in the NZE Scenario.

Announced capacity expansion plans show that the manufacturing of key wind components will remain concentrated in China. In the case of onshore components, China is expected to hold shares of 64% for global manufacturing capacity of nacelles, 63% for blades and 56% for towers once expansions are completed. Likewise, for offshore components China’s share of global offshore blade manufacturing capacity is due to rise to 80%, that of offshore nacelles to 70% and that of offshore towers to 60%. Surprisingly, although most component manufacturing capacity expansion plans are in China, most of the commissioned

onshore and offshore wind projects are taking place primarily in Europe and North America. In the case of onshore wind turbines, China accounts for 80-90% of announced manufacturing capacity additions of onshore nacelles, blades and towers, and for offshore turbines it is responsible for 35% of announced manufacturing capacity additions for nacelles, 75% for towers and 60% for blades. North America and Asia Pacific combined cover around 50% of announced expansions for offshore nacelles, while Europe accounts for 25% of all announced manufacturing additions for offshore blades.

While wind turbine and equipment manufacturers do not usually release details about planned component manufacturing capacity increases, some major announcements have been made recently. In April 2022, Envision announced its intention to build a new plant to produce blades with an aggregate capacity of around 2 GW per year (Lee, 2022), while Sinoma Science and Technology are investing USD 28.8 million to build a blade factory in Bahia, Brazil. Flender announced in September 2021 a plan to expand manufacturing capacity for wind drive systems in Tianjin (China) (Flender, 2021). MingYang Smart Energy is setting up a manufacturing facility capable of supplying 1 GW per year of turbines in Germany (Richard, 2021). In 2021, Al-Yamamah Wind Energy Systems announced an investment of around USD 80 million to open a tower factory in Saudi Arabia (Arab News, 2021).

Offshore wind manufacturing investment announcements have been more common recently, owing to increasing demand driven by policy incentives and capacity targets. This reflects to a large extent the greater attention given to offshore industry developments, partly due to their novelty and larger scale. Recent announcements include Goldwind's plans to invest around RMB 19 billion in 2022 to develop a wind power industry base, including wind turbine manufacturing, in China (Xiaomei, 2022). In 2021, the UK government announced an investment of around GBP 270 million to boost the offshore wind manufacturing industry in the Humber region, securing over 1 340 jobs (United Kingdom, UK Government, 2021). Siemens Gamesa announced in 2022 an expansion of its offshore nacelle manufacturing activities in Taiwan, tripling the capacity of the plants (Siemens Gamesa, 2022). In 2021, GE announced an expansion of its offshore wind nacelle factory in Montori de Bretagne (Buljan, 2021). In the United States, where the Biden administration has announced a goal of deploying 30 GW of offshore wind by 2030, recent investments in the offshore wind supply chain, including blades, nacelles, towers and substations, total over USD 1.5 billion (NREL, 2022).

Despite policy incentives and strong market signals in many countries, some wind manufacturers are struggling to increase output due to supply chain disruptions and higher costs resulting from the effects of the Covid-19 pandemic and Russia's invasion of Ukraine. Costs had been falling steadily before 2020, encouraging wind power developers to bid aggressively for new capacity in auctions and bilateral contracts, driving down prices to under USD 50/MWh in many regions. Technology innovation led to more efficient turbines, larger rotors and higher towers, while wind

farms were growing in size to exploit economies of scale. Manufacturers accommodated their supply chains to incorporate these upgrades. For instance, GE Renewable Energy expanded several times its Gaspé blade facility in Canada and Vestas invested in transforming its offshore nacelle factory at Lindø Port of Odense in Denmark to produce 15 MW offshore turbines. These innovation leaps led to a mindset in which manufacturers believed in infinite cost drops. Developers and manufacturers also took advantage of low interest rates and expansionary monetary policies. This expansionary cycle has since reversed. Vestas, Siemens Gamesa, General Electric and Nordex, which supplied more than 90% of the market outside China in 2021, all reported double-digit negative profit margins and negative cash flows for the first half of 2022 (Figure 4.7). Chinese manufacturers such as Goldwind are faring better, but also reported stagnant revenues and margins for the first half of 2022.

Figure 4.7 Financial indicators for non-Chinese wind turbine manufacturers

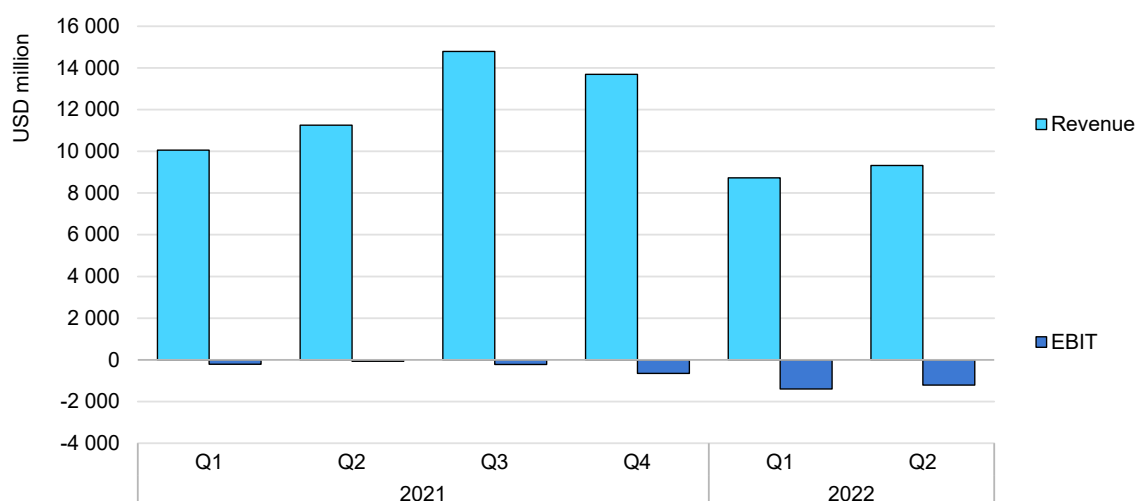

IEA. CC BY 4.0.

Notes: Q = quarter; EBIT = earnings before interest and tax. Companies surveyed include Vestas, Siemens Gamesa, GE Renewable Energy and Nordex.

The four leading non-Chinese wind turbine manufacturers have reported lower revenues and worsening losses since 2021, due to supply chain disruptions and cost pressures.

Regional policy and market developments

A number of countries around the world have focused on stimulating investment in wind energy through various measures, including mandated minimum shares in the power generation mix (renewable portfolio standards), feed-in tariffs, competitive tenders to procure wind projects, fiscal incentives such as tax credits or rebates and carbon pricing. Private companies have responded by targeting clean energy goals in their energy consumption mixes and, in the case of utilities, by offering long-term power purchase agreements to wind developers to guarantee stable cash flows. In response to recent supply chain problems, policy makers are now starting to pay more attention to the security of supply of wind equipment and components.

China's 14th Five-Year Plan provides for the continued expansion of wind deployment and manufacturing, setting more aggressive targets than the previous plan. Within its fundamental strategies, this plan puts wind and solar development as the top priority to enhance domestic energy supply and advance decarbonisation. Although it lacks specific targets for wind capacity additions, the plan aims to reach 1.2 TW of wind and solar capacity by 2030. To support this goal, the plan requires changes in regulations on grid connections to favour renewables and energy storage.

One of the main ways these goals are to be achieved is through the creation of so-called “clean energy bases” – unprecedentedly large-scale concentrations of wind and solar power. The bases are areas designated for the simultaneous construction of numerous large wind and solar parks, combined with long-distance transmission lines to demand centres. More than 500 GW of wind and solar projects have been identified under a central government scheme and are expected to be installed by 2030, with offshore wind bases accounting for 60 GW. Provincial targets and initiatives are also driving wind developments, especially offshore. Coastal provinces, including Guangdong, Fujian, Zhejiang, Jiangsu and Shandong, have set goals for building more than 60 GW of offshore wind plants in total by 2025.

Chinese wind turbine manufacturers profited from federal feed-in tariffs to scale up their businesses and achieve considerable cost reductions in the 2000s. However, this regime expired in 2020 for onshore wind and in 2021 for offshore wind, prompting developers to rush to commit to 70 GW of onshore wind capacity in 2020 and 17 GW of offshore in 2021 (compared with average annual deployment of 19 GW of onshore wind and less than 1 GW of offshore wind over the previous decade). This demonstrated the ability of wind turbine manufacturers to rapidly adjust their supply chains and accelerate production.

Most recent Chinese policy action has focused on setting deployment targets and stimulating investment in capacity, rather than reinforcing and strengthening supply chains. However, these incentives are attracting investment in increased domestic manufacturing capacity at all steps of the wind supply chain, as the country has access to cheap labour and raw material inputs (mostly steel) and has imposed high import tariffs on wind power-related goods.

In the **United States**, the IRA is currently the most influential piece of legislation affecting the wind turbine manufacturing industry in North America. It extends production tax credits and investment tax credits to wind projects that begin construction before the end of 2024 (they were due to end by 2022). However, these extensions are subject to conditions concerning wages and apprenticeships. The production tax credits should result in a levelised cost of new solar PV and wind capacity that is competitive with most other generating options, which Rystad Energy (2022) has estimated will drive a doubling of US onshore wind capacity by 2030.

The IRA supports wind turbine manufacturers indirectly by boosting developer demand for new turbines, nacelles and towers. It also grants additional tax credits for projects that meet certain domestic-content requirements. To claim the additional credit, developers must certify that any steel, iron or manufactured product that is a component of a facility upon completion of construction was produced in the United States. To protect its national manufacturing market, in 2021 the United States imposed anti-dumping duties and countervailing duties of as much as 73% on imported wind towers from Spain upon entry into the United States.

In **Europe**, REPowerEU aims to boost clean energy production, with the goal for renewable energy sources to make up 45% of the EU primary energy mix in 2030. The plan provides for EUR 86 billion of spending on renewables to 2027, as well as new legislation to speed permitting procedures for wind farms. Under this regulation, wind energy capacity is expected to more than double by 2030. The European Commission also imposed anti-dumping duties on imports of steel wind towers from China in 2021, ranging from 7.2% to 19.2%, after an investigation revealed that Chinese towers valued at around EUR 300 million were being imported at dumped prices (European Commission, 2021a).

EV batteries

Strong battery supply chains are crucial for realising EV deployment prospects, for both light-duty and heavy-duty vehicles. EV sales and production have accelerated tremendously over the past five years in response to policy incentives and strategic investments by carmakers, with the technology now seen as the primary means of decarbonising road transport. Strong policies have been introduced in all major car markets. If all current targets were achieved, 35% of cars sold globally in 2030 would be electric, with major markets such as the United States, China and Europe reaching over 50% by that year. Every major automobile manufacturer has responded by adopting ambitious multi-billion-dollar plans for electrifying their vehicle line-ups. Assembling EVs instead of conventional vehicles requires only minor retooling of existing factories. The principal change is the procurement of batteries, which account for 25-40% of the total cost of an EV and which have their own, completely different, supply chain.

Batteries are also used for grid-storage applications. In many instances, the technology (at the cell level) used for grid applications is very similar to that used for automotive applications. Their role is to enable the integration of more renewables into electricity systems by compensating for their intermittency and variability, though they still contribute to less than 10% of total battery demand in 2030 in the NZE Scenario.

Expansion plans and the gap with the net zero trajectory

Current EV battery industry expansion plans suggest that global manufacturing is broadly on track to meet the trajectory of demand required to attain net zero

emissions. Announcements by battery makers point to total manufacturing capacity of around 5 500 GWh per year by 2030 – over six times more than that available today and 80% of that required in the NZE Scenario (Figure 4.8). Of these announced projects, around one-third are already under construction. Announced plans for anode and cathode manufacturing indicate a more than tenfold increase in capacity for both products, exceeding the needs of the NZE Scenario. There was a surge in investment announcements in component manufacturing facilities in 2022, driven by China, of which roughly one-third are already under construction. Chemistry developments for batteries in the coming years mean that demand for specific types of cathodes is uncertain, though this investment surge could lead to oversupply by the end of the decade.

The time needed to build a battery factory is shrinking as more players gain the experience needed to set up operations rapidly. Lead times involved in advancing from announcing a new project to bringing production on line can be around four years for new companies, as was the case for Northvolt’s first plant in Sweden (2017-2022), but can be as short as six months when conditions are very good, as with CATL’s Shanghai plant in the second half of 2021 (they only had to install machinery, as the building was already available).

Figure 4.8 Battery and component manufacturing capacity by country/region according to announced projects and in the NZE Scenario

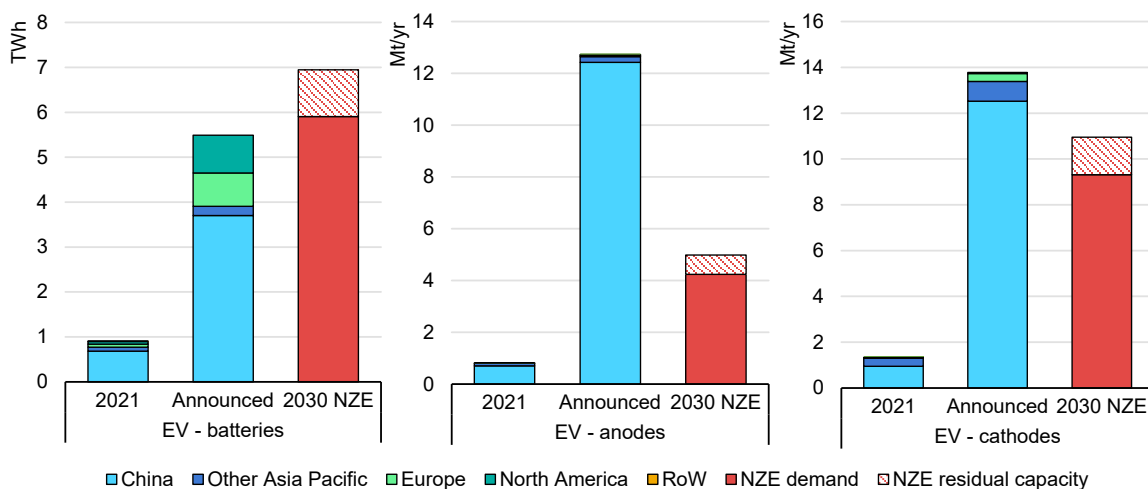

IEA. CC BY 4.0.

Notes: RoW = rest of world; NZE = Net Zero Emissions by 2050 Scenario. Announced capacity includes existing capacity. The manufacturing capacity needed to meet projected demand in the NZE Scenario (NZE demand) is estimated assuming a utilisation rate of 85%. NZE residual capacity, thus, represents the manufacturing capacity that would remain unused, on average, which provides some flexibility to accommodate demand fluctuations. Batteries for EV and grid storage applications are included in demand, with the latter accounting for 9% of the total in the NZE Scenario in 2030. Announced projects include battery factories from Tier 1 and Tier 2 battery makers, as per the Benchmark Mineral Intelligence classification.

Source: IEA analysis based on Benchmark Mineral Intelligence (2022).

Current expansion projects, mostly in China, are expected to boost EV battery production more than fivefold by 2030, meeting 80% of projected demand in 2030 in the NZE Scenario.

The battery industry is undergoing rapid change, with various new players entering the business in all major regions and existing manufacturers expanding their international operations and entering joint ventures with established automakers. The current pipeline of new projects is dominated by incumbents, led by China's CATL and BYD, the US company Tesla and Korea's LG Energy Solutions (LGES), which together account for 40% of global announced expansions (Table 4.2).

Table 4.2 Announced expansion projects of selected battery makers and automakers

Manufacturer	Company HQ	Manufacturing capacity	
		2021	2030
Battery maker (GWh/year)			
CATL	China	148	890
BYD	China	84	510
LGES	Korea	108	600
Tesla	United States	10	370
All companies		850	5 500
Automaker (million electric cars/year)			
Volkswagen	Germany	0.4	1.4
Tesla	United States	1.0	20
Toyota	Japan	0.1	3.5
All companies		6.6	

Note: HQ = headquarters.

Sources: Benchmark Mineral Intelligence (2022) and company announcements.

The geographical distribution of planned EV battery manufacturing expansions is more diverse than that of current capacity, so concentration is set to fall. The combined share of Europe and North America in global EV assembly capacity is expected to rise from 14% in 2021 to 24% once all expansions have all been brought on line, probably by 2025 according to current plans, though that of Japan and Korea would drop from 8% to 3% unless new projects are launched. China is nonetheless set to remain the dominant producer, its global market share holding firm at around 70% with planned capacity of 3 700 GWh. By contrast, planned investments in battery component manufacturing are much more heavily concentrated in China, with its share of global installed capacity set to exceed 90% for cathodes and 95% for anodes if all announced projects are brought to fruition. The only other region that is expected to increase its market share of cathodes and anodes is Europe thanks to investments made by chemical companies such as Umicore, with the region's share of global manufacturing capacity reaching around 3% for cathodes and 1% for anodes. Market shares decline in all other regions except China.

Regional policy and market developments

In **North America**, the IRA in the United States provides significant incentives to produce EVs and their components, by offering grants to build new capacity and restricting EV purchase incentives to vehicles manufactured domestically. Even before the IRA was enacted, important investments had been announced in the United States, as well as in Canada and Mexico. Since North America is a major automotive market, with sales of over 16 million cars per year, the shift to EVs is inevitably spurring interest in producing batteries and their components locally for logistical and cost reasons, a trend that will be reinforced by the IRA.

There has been strong co-operation through joint ventures with Japanese and Korean battery manufacturers, following the model that brought Tesla success in its relationship with Japan's Panasonic, which began in 2009 (Tesla, 2011). From Korea's LGES partnership with General Motors, which started in 2019, one battery factory in the United States is already operational and three more have been announced (Shepardson, 2022), while Stellantis announced plans to partner with LGES to build a factory in Canada in 2021 (Stellantis, 2022). Tesla plans to significantly increase its battery manufacturing capacity in the United States by tripling capacity at its Gigafactory 1 facility, as well as opening a new factory in Texas. Based on these investments, battery manufacturing capacity in North America is expected to increase to around 840 GWh. This would meet about 80% of targeted regional demand in 2030 under announced pledges. However, more plans to expand capacity are expected to be announced in upcoming months and years owing to IRA incentives.

North America depends heavily on imports for its battery component supplies. In aggregate, the region has manufacturing capacity of less than 15 kt of cathode material and under 5 kt of anode material, importing around 85% of all its domestic battery component needs on a net basis in 2021. Once all announced capacity expansions for anode and cathode manufacturing have been completed, as much as 55 kt of these components – equivalent to that needed to produce 35 GWh of batteries – could be produced in the region, though this is equal to just 5% of what is needed to supply all planned battery capacity. It is likely that the IRA will encourage battery component manufacturers to invest even more in the region.

In **Europe**, battery capacity expansions are being triggered by surging demand from automakers as they gear up to expand electric car production to keep up with EV demand, which is being driven by new EU CO₂ emissions standards and the mandatory phaseout of internal combustion engine vehicles. The share of EVs in the region's total passenger car sales would reach over 50% in 2030 assuming current targets are met. Battery supply is also being boosted by two EU Important Projects of Common European Interest (IPCEI), which provide for EUR 6.1 billion to be invested directly by the European Union and member state governments to leverage private capital to build up domestic battery supply chains. Volkswagen

alone aims for manufacturing capacity of 240 GWh in Europe by 2030 (Volkswagen, 2021), while several other automakers have joined forces with local and foreign battery makers to increase production. For example, Stellantis, Saft and Mercedes Benz have created a joint venture – ACC – which aims to install manufacturing capacity of nearly 120 GWh by 2030 (ACC, 2022). Together, these projects would boost European manufacturing capacity to over 740 GWh, which is equivalent to projected demand in the region in 2030 if announced policy targets are met.

Production of upstream battery components is also expanding, with incumbent European chemical companies such as Umicore and BASF leading investment. Total manufacturing capacity for cathodes in the region is expected to reach 340 kt (equivalent to 225 GWh of battery production) based on current plans, accounting for about one-third of targeted European demand in 2030 under current government announcements.

After a decade of strong growth resulting from a clear EV policy combined with a strategic policy on EV battery value chains, **China** is at the centre of the global battery supply chain. The main driver of growth in battery and component production in coming years will be domestic demand for EVs. The world's largest battery maker, CATL, has a global market share of one-third (Bloomberg, 2022). Planned and ongoing investments by the company could boost manufacturing capacity to nearly 890 GWh – six times the 2021 level. Component manufacturing is also growing rapidly as established companies continue to exploit their competitive advantage resulting from access to cheap materials and a large domestic demand market. China accounts for 95% of growth in cathode and anode manufacturing capacity worldwide under current plans.

Fuel cell trucks

Fuel cell electric vehicles (FCEVs) powered by hydrogen have been under development for decades, but commercialisation of cars and buses began only in the last 10-15 years. More recently, attention has shifted to the development of heavy-duty trucks, for which fuel cell technologies can offer advantages over standard battery EV technologies in terms of range, refuelling time²⁸ and energy density (which allows for heavier payloads). However, competition with battery electric trucks is fierce because battery costs are falling rapidly and deployment plans are growing quickly. As a result, future fuel cell truck deployment is highly uncertain.

²⁸ See Chapter 5 for a discussion of hydrogen refuelling technologies for heavy-duty fuel cell trucks.

Governments and industry are showing a growing commitment to decarbonising heavy-duty trucking, exemplified by the Memorandum of Understanding on Zero-Emission Medium- and Heavy-Duty Vehicles signed by 16 countries in 2021 and another 11 countries in 2022, which sets a goal of 100% zero-emission truck and bus sales by 2040 (with an interim target of 30% by 2030). Were current government targets to be achieved, about 7% of heavy-duty truck sales globally in 2030 would be low emissions, of which we project about 10% (over 20 000) would be fuel cell trucks, mainly serving the long-haul trucking sector.

Expansion plans and the gap with the net zero trajectory

Manufacturer announcements suggest that global heavy-duty fuel cell truck manufacturing capacity will reach over 90 000 trucks per year by 2030. This is about seven times existing manufacturing capacity and would account for about 50% of that required in the NZE Scenario. There is plenty of time to make up the shortfall. Ground-breaking of a manufacturing site to the start of fuel cell truck manufacturing can take as little as six months for relatively small facilities manufacturing around 3 000 trucks per year (for example, the SAIC Hongyan plant commissioned in 2021 [Electrify, 2022]). Expanding a factory of this size to a capacity of about 20 000 trucks per year can take another year or two.

Figure 4.9 Heavy-duty fuel cell truck and mobile fuel cell manufacturing capacity by country/region according to announced projects and in the NZE Scenario

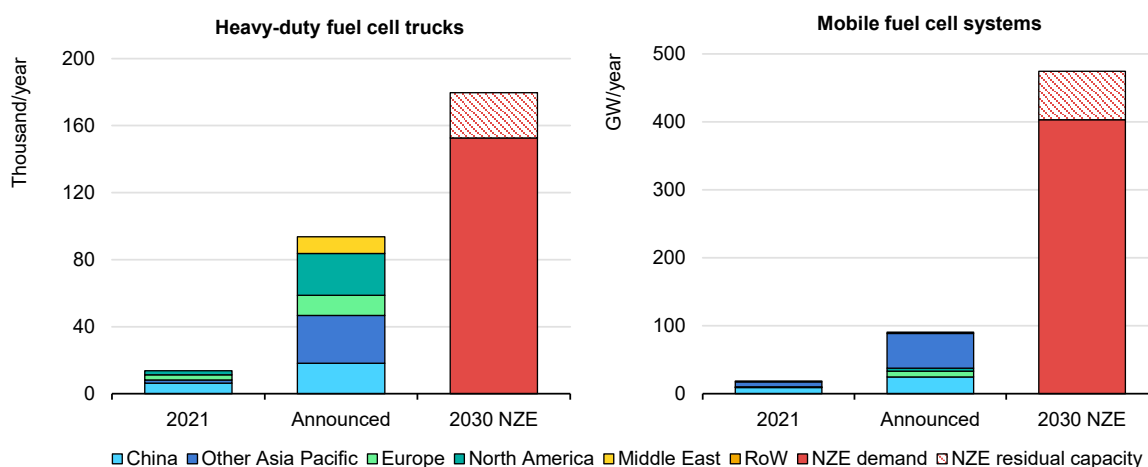

IEA. CC BY 4.0.

Notes: RoW = rest of world; NZE = Net Zero Emissions by 2050 Scenario. Announced capacity includes existing capacity. The manufacturing capacity needed to meet projected demand in the NZE Scenario (NZE demand) is estimated assuming a utilisation rate of 85%. NZE residual capacity, thus, represents the manufacturing capacity that would remain unused, on average, which provides some flexibility to accommodate demand fluctuations. Capacities in 2021 and announced capacities include material handling equipment and other transport applications; NZE demand for fuel cells is based on fuel cell vehicles only.

Sources: IEA analysis based on Samsun et al. (2022), E4tech (2022) and company announcements.

Expansion projects indicate a sevenfold increase in global fuel cell truck manufacturing capacity to 90 000 trucks per year by 2030 – 50% of that required in the NZE Scenario.

Fuel cell manufacturing announcements indicate that automotive fuel cell manufacturing capacity will increase fivefold to 90 GW/year by 2030. Based on projected fuel cell truck sales in 2030 in the NZE Scenario, only an estimated one-third of announced fuel cell manufacturing capacity would need to be used for truck manufacturing. Fuel cell manufacturing is expected to be able to keep pace with growth in demand, since new factories can take as little as a year or two to bring on line. In addition, fuel cell truck manufacturers tend to either make their fuel cells in-house or set up partnerships with fuel cell manufacturers. For example, Daimler and Volvo have set up a joint venture, Cellcentric, to supply fuel cell systems for heavy-duty trucks, while Toyota is planning to open a manufacturing facility in the United States to produce fuel cell powertrain modules for heavy-duty trucks.

Table 4.3 Expansion plans of selected heavy-duty fuel cell truck and fuel cell manufacturers

Manufacturer	Company HQ	Manufacturing capacity	
		2021	2030
Heavy-duty fuel cell truck manufacturers (trucks/year)			
Hyzon	United States	1 000	40 000
Nikola	United States	4 500	30 000
Hyundai	Korea	2 000	11 000
Fuel cell manufacturers (systems/year)			
Hyundai	Korea	40 000	500 000
Symbio	France	--	200 000
HydraV	China	25 000	100 000

Source: Fuel cell manufacturing capacity data from E4tech (2022).

Several expansions of manufacturing capacity for fuel cell components (including membrane electrode assemblies [MEAs] and bipolar plates) as well as for hydrogen storage tanks for FCEVs have also been announced. Hyzon, a fuel cell truck manufacturer, announced in 2021 the construction of an MEA manufacturing facility in the United States, which at full capacity will make enough MEAs to support the production of 12 000 fuel cell trucks per year (Hyzon, 2021). Dana, which produces bipolar plates for Bosch, which in turn supplies fuel cell systems to Nikola, announced plans to expand its German facility from 350 000 to 4 million plates per year in the next year or two (Innovationsregion Ulm, 2022). With respect to storage tanks, Faurecia (a Hyundai partner) recently announced its plans to expand a factory in France from 10 000 to 100 000 tanks per year by 2025 (Surfeo, 2022).

Nikola and Hyzon,²⁹ both American-headquartered companies founded in the last ten years to supply zero-emission heavy-duty trucks, account for the bulk of

²⁹ Although Hyzon itself was founded in 2020, it began as a subsidiary of Singapore-based Horizon Fuel Cell Technologies with almost 20 years of experience developing fuel cells.

announced fuel cell truck manufacturing capacity expansions. Nikola can increase its manufacturing capacity almost sevenfold just by expanding existing plants. Hyzon plans for manufacturing lines to reach a capacity of 40 000 fuel cell vehicles (including heavy-duty trucks and buses) per year by 2025. Together, these two companies could supply almost half of projected NZE Scenario demand in 2030 if their plans come to fruition.

Toyota and Hyundai, which have a long history of developing fuel cell vehicles, have also begun producing heavy-duty fuel cell trucks, while other truck makers (e.g. Daimler, MAN, Scania, Volvo and DAF) have announced their intention to do so. Announcements about future manufacturing capacity, however, have been fairly limited, including for Chinese companies, which have made the largest number of heavy-duty fuel cell trucks to date. Hyundai is opening a fuel cell truck manufacturing plant in China with an initial capacity of 6 500 trucks per year, but otherwise sales targets are the only indication of manufacturing capacity expansions. In general, incumbent truck makers should be able to modify current production lines to manufacture fuel cell trucks to meet potential future demand. For these reasons, the lack of announcements should not be seen as a hurdle to producing the 150 000 heavy-duty fuel cell trucks needed in 2030 in the NZE Scenario. To put this into perspective, Hyundai's Jeonju plant in Korea currently has a capacity of over 100 000 commercial vehicles per year.

The geographical distribution of heavy-duty fuel cell truck manufacturing capacity is set to become more diverse based on announced expansions. China's share in global capacity would drop from 45% in 2021 to 20% in 2030 if all current plans are fulfilled and no other expansions are undertaken. Manufacturing capacity in the United States would grow ten times to 25 000 trucks per year over the same period based on announcements from Hyzon and Nikola, though its share of global manufacturing capacity would only reach about 25%. Manufacturing capacity in Europe could rise to around 12 000 trucks per year in 2030 based on Nikola's and Daimler's announcements (it is assumed that Hyundai will continue manufacturing fuel cell trucks for the European market in Korea). Based on announced sales targets for Europe and the United States, Korean manufacturing capacity would increase from 2 000 trucks per year today to 4 500 per year in 2030. Based on Hyzon's announced target capacity globally, and specified capacity in the United States and Europe, capacity in other regions could reach almost 35 000 trucks per year, including new manufacturing capacity of 10 000 per year in Saudi Arabia.

Korea is set to become even more important in the manufacturing of mobile fuel cells, many of them destined for trucks, with its global market share jumping from 20% in 2021 to over 50% in 2030. Such is the scale of Hyundai's announcement that China's share would plunge from 50% to 25%. Because Toyota has not made any announcements about expanding capacity, Japan's share would drop from almost 20% today to less than 5% in 2030, though Toyota is known to be capable of expanding manufacturing capacity rapidly as demand grows.

Regional policy and market developments

Fuel cell truck deployment is at a very early stage, so industry professionals across and along the supply chain, including fuel cell suppliers, truck manufacturers, hydrogen producers and refuelling station developers, have formed partnerships, collaborations and joint ventures to support market expansion. Industry activity and investment is, unsurprisingly, focused on countries with supportive policy frameworks.

In **Europe**, government support and private sector commitments to climate neutrality suggest an environment that is potentially conducive to fuel cell trucks. Recently, the European Commission launched the Alternative Fuels Infrastructure Facility to support the building of infrastructure for low-emission vehicles, including hydrogen refuelling stations. In addition, the proposed Alternative Fuelling Infrastructure Regulation would set requirements on the availability of hydrogen refuelling stations. In Switzerland, federal taxes on heavy vehicles have encouraged deployment of heavy-duty fuel cell trucks, as electric drivetrains benefit from a tax exemption.

The European Union has also provided funding for a number of projects to support fuel cell truck deployment. For example, the H2Haul project is under way to deploy them, certifying them as safe for European roads, and to install hydrogen refuelling infrastructure. In addition, the European Union's PRHYDE project aims to develop recommendations for a non-proprietary heavy-duty refuelling protocol to be used for future standardisation activities for trucks and other heavy-duty transport systems using hydrogen technologies.

In 2020, a coalition statement including industry stakeholders such as Toyota, Hyundai, Hyzon and Ballard described a joint ambition to deploy 100 000 heavy-duty fuel cell and hydrogen trucks in Europe from 2030 (Fuel Cells and Hydrogen Joint Undertaking & Hydrogen Europe, 2020). In addition, the collaborative H2Accelerate initiative, involving Daimler Truck AG, IVECO, OMV, Shell, TotalEnergies and Volvo Group, is assessing the technical and commercial viability of hydrogen-fuelled trucking.

In the **United States**, the Department of Energy has set ambitious targets for heavy-duty fuel cell trucks to make them competitive with conventional diesel trucks. To support this goal, the Hydrogen and Fuel Cell Technologies Office has co-funded, with industry, first-of-a-kind research and modelling capabilities to support medium- and heavy-duty hydrogen fuelling protocols and hardware development at the National Renewable Energy Laboratory.

Although there is no federal regulation requiring the transition to zero-emissions trucks, California's Advanced Clean Trucks Rule requires that 40-75% of heavy-duty truck sales, depending on truck type, be zero-emissions by 2035. Following this ruling, another 16 states plus the District of Columbia, as well as Canada's province of Quebec, signed a memorandum of understanding (MOU) establishing

goals to make at least 30% of new medium- and heavy-duty vehicle sales zero-emissions by 2030 and 100% by no later than 2050. Canada is also part of a Global MOU on Zero-Emission Medium- and Heavy-Duty Vehicles, which aims for 100% zero-emissions truck and bus sales by 2040 (with an interim target of 30% by 2030). At present, the only public hydrogen refuelling stations operating in the United States are in California. Nikola aims to extend the network by forming partnerships with infrastructure and fuel providers to support fleets of heavy-duty fuel cell trucks.

In **Korea**, the government's Hydrogen Economy Roadmap lays out targets for fuel cell vehicle production, exports and domestic deployment. It includes a target of 30 000 fuel cell trucks on the road by 2040. The KOHYGEN consortium, formed in 2021, aims to build 300 heavy-duty hydrogen stations by 2040 to support fuel cell truck deployment. Korea's Hyundai Motors has a long history of fuel cell development, beginning in 1998. In its recent FCEV Vision 2030, Hyundai Motor Group announced a goal to produce 700 000 fuel cell systems annually, including 500 000 for FCEVs. To support this, it is opening a second fuel cell manufacturing facility in Korea.

Since the early 2000s, **Japan's** New Energy and Industrial Technology Development Organization (NEDO) has been releasing technology roadmaps to expand fuel cell technologies and providing grants to support expansion. The leading Japanese automakers, Toyota and Honda, have been among the leaders in commercialising FCEVs. In 2019, Japan's third Strategic Roadmap for Hydrogen and Fuel Cells set the goal of 800 000 fuel cell vehicles by 2030. In March 2022, NEDO released the Fuel Cell Heavy Duty Vehicle Technology Roadmap, which set targets for 2030 and 2040 for the domestic deployment of fuel cell trucks. Recently, Hino, a Toyota subsidiary that makes commercial vehicles, received a grant from NEDO to test such a truck at Californian ports.

In **China**, in 2022 the government launched its first national-level hydrogen development plan with the goal of having 50 000 fuel cell vehicles in operation by 2025. In its 14th Five-Year Plan, hydrogen was one of six areas of focus. Historically, China has prioritised the development and deployment of heavy-duty FCEVs, including trucks and buses, making it the leader in deployment of both. Many manufacturers have leveraged their experience, or the experience of parent and sister companies, in fuel cell bus manufacturing to expand to heavy-duty trucks. Chinese success in the early deployment of FCEVs can be credited, to some extent, to partnerships and joint ventures with non-Chinese fuel cell providers. While fuel cell manufacturers such as Ballard, Hyundai and Toyota are still involved in the Chinese market, domestic companies are playing a growing role.

Heat pumps

Heat pumps³⁰ are rapidly penetrating major heating markets, particularly North America, Europe and northern and eastern Asia. Heat pump technologies can be deployed in a broad range of climates and tailored to provide both heating and cooling (reversible units) or heating only (space and/or water). Air-to-air, air-to-water and water or ground-source heat pumps have been available for many years, with uptake driven primarily by growing demand for space cooling services (using air-air units) and by policies to replace fossil fuel-based alternatives. Only recently have electric heat pumps been recognised more widely as one of the critical technologies to decarbonise low- and medium-temperature heat production, due to their higher efficiency compared with conventional options and the ongoing decarbonisation of power generation. They covered less than 10% of global heating needs in 2021, but sales grew 13% to a record level in 2021 despite Covid-19-related supply chain disruptions (shortages and longer delivery times for heat pump components and materials) and continued to rise strongly in 2022 (IEA, 2022c).

Part of the reason for growing heat pump demand is increased policy support in several countries with large heating markets, as well as record-high natural gas prices since Russia's invasion of Ukraine, particularly in Europe. Financial incentives are currently available in over 30 countries, which together cover more than 70% of today's heating demand (IEA, 2022d). As a result, part of the boiler industry is horizontally diversifying towards heat pumps: around half of heat pumps today are made by manufacturers that also make boilers, exploiting synergies in hydronic systems. Most air conditioner (AC) manufacturers also produce air-source heat pumps and are also expanding to cover the hydronic segment or vice versa: in 2021, around 75% of heat pump manufacturing capacity was in the hands of AC manufacturers, often in the same facility to exploit the synergies of air-to-air systems (Box 4.3).

Expansion plans and the gap with the net zero trajectory

Manufacturing capacity is set to grow in the next few years, but how quickly is very uncertain, as few expansion projects are ever widely announced or publicised. Global heat pump manufacturing capacity would need to almost quadruple to around 460 GW_{th} in 2030 to meet projected demand in the NZE Scenario (Figure 4.10). Unsurprisingly, capacity expansion that would result from publicly announced projects under way or planned falls far short of this goal and of the

³⁰ Heat pumps included in this analysis are those primarily used for heating (space and/or water) in buildings and those for which the heating function is just as important as the cooling capability, aiming to exclude as much as possible air-air reversible heat pump units used primarily for space cooling. They include both centralised and decentralised units in buildings.

collective targets set by governments around the world, although in reality, expansion is likely to be much greater by 2030. Lead times for manufacturing expansions or for construction of new factories are relatively short, ranging from one to three years.

By fully exploiting existing facilities, current global manufacturing capacity could already increase production by an average 20% compared with 2021,³¹ providing flexibility to meet demand growth over the next 12-18 months, assuming components are available (see Chapter 2). Greater standardisation of devices and automation of production lines, including improved testing facilities, are critical to further boost manufacturing capacity on existing lines while new manufacturing sites are being constructed. Meeting NZE Scenario requirements in 2030 would require a total of roughly USD 15 billion in cumulative investment to expand manufacturing capacity, beyond what has already been announced.

Figure 4.10 Heat pump manufacturing capacity by country/region according to announced projects and in the NZE Scenario

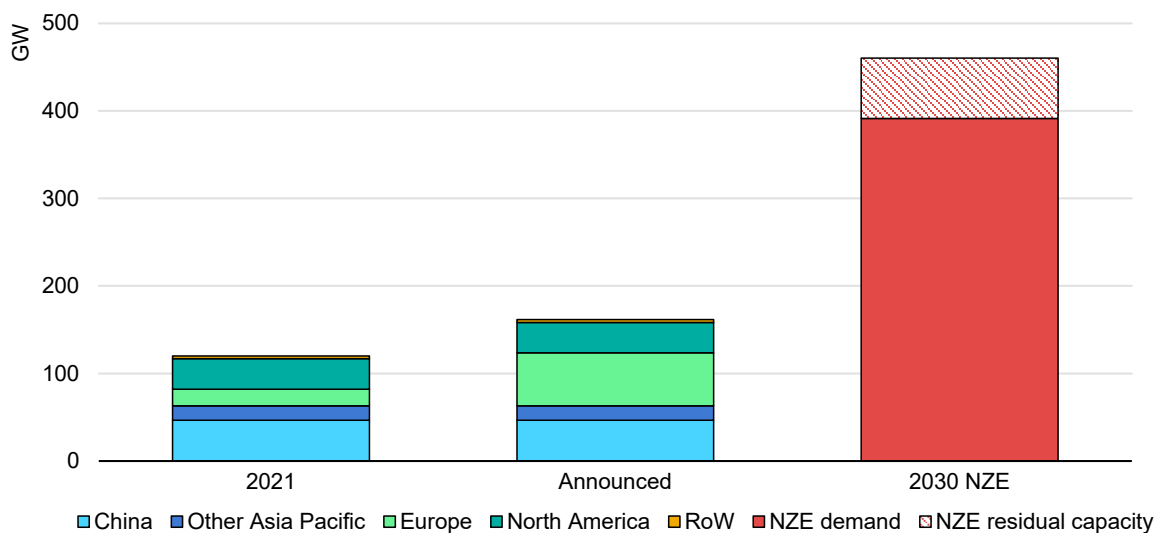

IEA. CC BY 4.0.

Notes: RoW = rest of world; NZE = Net Zero Emissions by 2050 Scenario. Announced capacity includes existing capacity. The manufacturing capacity needed to meet projected demand in the NZE Scenario (NZE demand) is estimated assuming a utilisation rate of 85%. NZE residual capacity, thus, represents the manufacturing capacity that would remain unused, on average, which provides some flexibility to accommodate demand fluctuations. Heat pump capacity (in GW) is expressed as thermal output capacity. By and large, Europe is the main region to have concrete public expansion plans from manufacturers in place.

Announced heat pump manufacturing capacity covers only one-third of NZE Scenario requirements for 2030, but short lead times mean that capacity could expand quickly.

As with other mass-manufactured technologies, for which capacity expansions typically follow near-term demand trends, few heat pump manufacturers have

³¹ Based on research, industry consultation and data from Global Research View.

announced expansion plans, partly because heat pumps often represent a small proportion of their total production. Europe is something of an exception, with 13 manufacturers in Germany, Poland, Belgium, Republic of Türkiye, the United Kingdom, France, Sweden, Slovakia and the Czech Republic having made their concrete expansion plans public (Table 4.4). About 25% of these announcements are from Japanese companies, 2% are from Midea, a Chinese manufacturer, and the rest are from companies headquartered in Europe. About half of the total investments involves the expansion of existing factories. In November 2022, a Chinese manufacturer announced investments of about USD 45 million for a new factory in the country, perhaps an early sign that expansion plans may also become public in regions outside of Europe. The realisation of announced investments over this decade would triple European manufacturing capacity, while global capacity would increase by roughly 35%, though capacity would remain 50% below collective targets for 2030 under current announced government ambitions.

Like heat pump producers, component manufacturers rarely publicise their expansion plans. Nonetheless, most of the heat pump industry appears confident that it will be able to ramp up output quickly enough to meet a 15-20%-per-year demand increase. Demand will largely depend on the policy landscape. Bottlenecks in components, notably semiconductors and compressors, could emerge, especially if rapid changes to heat pump and refrigerant standards disrupt supply chains. Some manufacturers, responsible for producing over 30% of heat pumps worldwide in 2021, already produce their own compressors. While compressors are needed in many industries, some heat pump compressors might require specific designs for certain temperatures ranges and refrigerants. Thus, harmonisation of international standards will be essential to ensure that compressor suppliers can meet demand in a timely way. Policies to support the domestic manufacturing of such components could offer broader benefits such as lower transportation costs, which currently constitute 6-14% of total heat pump costs, and faster heat pump production (United Kingdom, BEIS, 2020).

Table 4.4 Announced heat pump manufacturer expansion projects by country and type of investment

Heat pump manufacturer	HQ location, 2021	Region of announced expansion	Project period	Million USD	Type of investment
Daikin*	Japan	Poland	2022-25	300	New factory
		Belgium	2022-23	10	Expansion
		Germany	2022-25	N/A	Expansion
		Czech Republic	2022-25	50	Expansion
Mitsubishi	Japan	Türkiye	2022-24	115	Expansion
		United Kingdom	2021-22	15	Expansion
Panasonic	Japan	Czech Republic	2022-26	145	Expansion
Stiebel Eltron	Germany	Germany	2022-25	600	Expansion
Bosch Group	Germany	N/A	2022-25	350	N/A
		Portugal	2022-23	10	Expansion
Viessmann	Germany	Poland	2022-23	200	Expansion
Vaillant	Germany	Slovakia	N/A	120	Expansion
		United Kingdom	2022	3	Expansion
Saunier Duval	Germany	France	2020-23	10	Expansion
Hoval	Liechtenstein	Slovakia	-2024	40	Expansion, New factory
Clade	United Kingdom	United Kingdom	N/A	N/A	Expansion
Midea Group	China	Italy	2022-24	60	New factory
NIBE	Sweden	Sweden	2023-26	445	N/A
Ideal Heating	United Kingdom	United Kingdom	2021-23	20	Expansion
Guangdong Ruixing	China	China	N/A	45	New factory

*Daikin also announced a target annual growth rate of 20% to 2030, in Europe.

Notes: HQ = headquarters; N/A = not available. As not explicitly linked to expansion plans, this table excludes an additional investment of EUR 1 billion announced by Viessmann to expand its climate solution portfolio, including heat pumps, and a USD 115 million loan received by Vaillant to finance heat pump R&D.

Source: IEA research based on company announcements.

Today, China, Japan and Korea are net exporters of heat pumps, while North America and Europe are net importers (see Chapter 2). Several countries are implementing policies to scale up domestic manufacturing, and several new enterprises are entering the heat pump market to meet growing demand. Overall, heat pump manufacturing capacity is evenly distributed geographically and the market is less concentrated than for most other mass-manufactured clean energy

technologies. This is not expected to change much before 2030 according to current trends and investment plans. Companies based in northern and eastern Asia are expected to remain the largest producers, but significant capacity growth is expected in both Europe and North America.

Regional policy and market developments

Various policies are in place to support the heat pump market and overcome current deployment barriers. Building codes and standards, financial instruments, targeted energy pricing, mandatory performance-based labels, renewable/energy efficiency targets and measures to ban fossil fuel installations have been and will continue to be instrumental, not only to drive uptake of this technology, but also to spur innovation. Policies to reinforce supply chains are generally less common, but they are emerging in several countries.

In **Europe** several policies are in place to both drive technology deployment and reinforce supply chains to maintain and expand European heat pump industry capacity and competitiveness, attracting investments from manufacturers (Table 4.4). Bans on new fossil fuel-fired boiler installations are also part of policy packages in various countries, and financial support schemes to reduce the relatively high upfront capital costs of residential heat pumps are also present in more than 25 countries (IEA, 2022d). While building energy codes are becoming more stringent all over Europe, heat pumps have also been promoted for many years as part of the Passivhaus standard (Passive House Institute, 2022). Such policies have been critical to attract investment in the region.

REPowerEU aims to double the current heat pump deployment rate, which would lead to the installation of 30 million new heat pump units between 2022 and 2030. A number of European countries have set heat pump targets: for example, 6 million in Germany by 2030 (AGORA Energiewende, 2021), which would require a threefold increase in annual installations compared with 2021, and 600 000 installations per year in the United Kingdom by 2028 (United Kingdom, HM Government, 2020) – a 14-fold increase. Other European countries with targets are Belgium, France, Hungary, Italy, Poland and Spain (IEA, 2022d).

Measures to reinforce heat pump supply chains are also emerging: for example, the United Kingdom has set aside GBP 30 million for a Heat Pump Investment Accelerator Competition as part of its Energy Security Strategy 2022 (United Kingdom, HM Government, 2022).

In the **United States**, policy actions to scale up domestic demand and manufacturing capacity in the last few years have strengthened the heat pump market and aim to fully cover rising demand with domestic production. The most recent example is the IRA, which plans to promote heat pump installation through tax credits, purchase incentives and rebates. Policy action is also

happening at the regional level: for example, New York City will ban natural gas use in new buildings of up to seven storeys by 2023, and for those over seven storeys by 2027. In California, in 2021 the California Energy Commission approved the first building code in the nation to include heat pumps as a baseline technology. To accelerate the deployment of cold-climate heat pumps, the US Department of Energy launched the Residential Cold Climate Heat Pump Technology Challenge to commercialise this technology by 2024 (United States, DOE, 2022a).

The United States recently affirmed the importance of heat pump technologies in a presidential determination to invoke the Defense Production Act (DPA) for five key energy technologies important for energy security. The inclusion of heat pumps will allow the federal government to use a variety of tools to expand domestic heat pump manufacturing. Through the IRA, Congress appropriated USD 250 million in investments for domestic heat pump manufacturing (United States, DOE, 2022b). The non-profit organisation Rewiring America also proposed a policy plan to boost heat pump and component manufacturing through measures such as public-private cost sharing (Rewiring America, 2022).

In **China**, the government has introduced several measures over the last few years to boost heat pump supplies and usage. Since 2016, heat pumps have gained momentum in northern China in particular, being a key component of the Coal to Electricity Programme, the Air Pollution Prevention and Control Law and the Clean Winter Heating Plan for Northern China to retrofit coal-fired household heating, especially in rural areas. In 2022, the Chinese government released the Carbon Peaking Action Plan for Urban Rural Construction, which highlights heat pump use to decarbonise space and water heating. In 2022, a new building regulation introduced requirements for installed heating, ventilation and air conditioning (HVAC) systems, including heat pumps. These policies to boost demand for heat pumps, coupled with growing demand for space cooling equipment, are at the core of the growth in Chinese manufacturing capacity, with hundreds of newly registered factories established every year (AskCI, 2022) because China does not import heat pumps, largely due to high import tariffs. China is currently the world's largest producer of heat pumps, accounting for about 40% of global manufacturing capacity.³² In November 2022 China's National Development and Reform Commission (NDRC) released a new policy to stimulate the manufacture of more efficient products, covering 20 product types including low-temperature air-source heat pumps, multi-connected air conditioners, and heat pump water heaters (China, NDRC, 2022).

³² Excluding air conditioners.

Box 4.3 The heat pump market: Synergies between end uses and subsectors

An important feature of heat pumps used for heating in buildings is that the thermodynamic cycle at the heart of the technology – and thus most of the key components – is common to air conditioning and refrigeration and can be used in many other sectors such as road vehicles, industry and district heating. With the use of heat pumps in all these applications expected to grow, synergies among shared components and raw materials can be exploited, as well as shared skills (e.g. aluminium casting is required for manufacturing both automotive parts and heat pumps).

There are particularly several potential synergies between heat pumps and air conditioning, demand for which is growing strongly (Figure 4.11). For example, there is flexibility to shift assembly lines between air conditioners and heat pumps, which could provide an important capacity buffer to scale up heat pump manufacturing, especially during this decade. In addition, manufacturers can invest in R&D themes that could simultaneously benefit both the heating and cooling markets, with potential to also reduce equipment costs 10-15% by 2050 (IEA, 2020). There are also opportunities to develop more efficient combined solutions (e.g. exploiting waste heat from air conditioning to produce hot water during the summer).

Figure 4.11 Global annual sales of heat pump technologies for buildings in the NZE Scenario

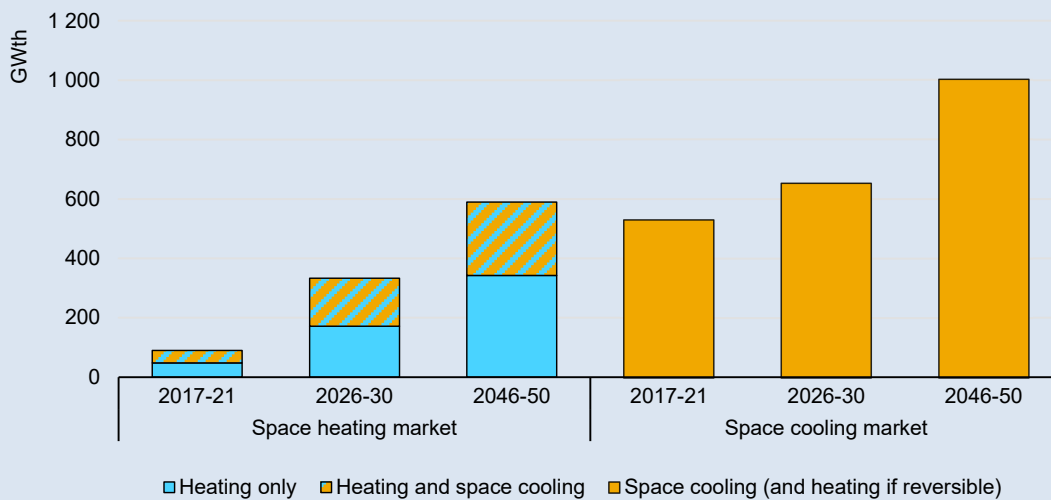

Note: Systems categorised as "heating and space cooling" are reversible units intended for both space heating and cooling. Systems categorised as "space cooling" may also include reversible units that can provide heat, but the primary function is cooling. The allocation applied here avoids double counting.

IEA. CC BY 4.0.

Electrolysers

Interest in low-emission hydrogen and derivative fuels has been growing in recent years in recognition of their potential to replace fossil fuels in end uses that are difficult to decarbonise, such as heavy industry, shipping, aviation and heavy-duty road transport. The sharp fall in renewable electricity costs along with continued innovation and scaleup in electrolysis technologies have brought renewable hydrogen closer to cost competitiveness with unabated fossil fuel-based hydrogen.

Expansion plans and the gap with the net zero trajectory

In general, information about manufacturing capacity for electrolyser components, including bipolar plates, gas diffusion layers and membranes (the need for which varies significantly among different designs), is very scarce. This creates uncertainty about potential supply chain bottlenecks and the challenges involved in electrolyser expansion. According to company announcements, electrolyser manufacturing capacity is set to grow tenfold to more than 100 GW per year by 2030, accompanied by a similar expansion of component manufacturing capacity (Figure 4.12). Yet this impressive growth, even if fully realised, is still insufficient to meet projected near-term electrolyser demand growth in the NZE Scenario, covering only about half of the 200-GW-per-year manufacturing capacity required in 2030. Moreover, only around 8% of announced electrolyser manufacturing capacity expansion has reached final investment decision. Both government targets and industry plans to invest in installing electrolysers also fall short of projected deployment in the NZE Scenario, in which more than 700 GW of electrolysis capacity is installed by 2030 (IEA, 2022e). Government targets in aggregate call for capacity of just 145-190 GW, while projects currently under development, if completed in full and on time, would result in 240 GW of capacity by then.

Making good the shortfall in manufacturing capacity is complicated by the fact that electrolysis has to grow from the lowest base of all the main clean energy technologies discussed in this report: current capacity is only 5% of that required in 2030 in the NZE Scenario. Nonetheless, the relatively short lead times involved in building electrolyser factories mean that new projects could allow the NZE level of output to be achieved. Typically, developing an electrolyser facility takes two to three years, as was the case with ITM Power (2019-2021) (ITM Power, 2021) and Plug Power (2019-2021) (Plug Power, 2021a). Expanding existing facilities, as some manufacturers are planning to do, could be much quicker, especially when the potential for future expansion is integrated into the design of a new facility.

Figure 4.12 Electrolyser manufacturing capacity by country/region according to announced projects and in the NZE Scenario

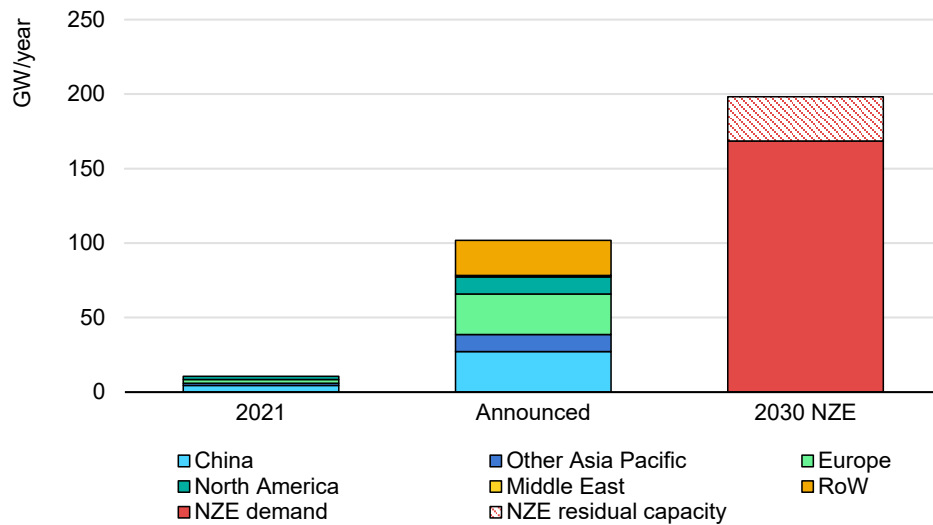

IEA. CC BY 4.0.

Notes: RoW = rest of world; NZE = Net Zero Emissions by 2050 Scenario. Announced capacity includes existing capacity. The manufacturing capacity needed to meet projected demand in the NZE Scenario (NZE demand) is estimated assuming a utilisation rate of 85%. NZE residual capacity, thus, represents the manufacturing capacity that would remain unused, on average, which provides some flexibility to accommodate demand fluctuations.

Electrolyser manufacturing capacity is set to expand almost tenfold to more than 100 GW by 2030, but this would still cover only half of NZE Scenario requirements.

Electrolysers have been manufactured at industrial scale since the early 20th century for their use in the chlor-alkali industry. This application still accounts for the majority of electrolyser demand, whereas their use for dedicated hydrogen production is still in the early stages of commercialisation (IEA, 2022e). However, this is expected to change in the very short term and electrolyser manufacturers are preparing for a massive scaleup in demand for dedicated hydrogen production.

Announcements of plans to develop electrolyser manufacturing capacities are coming from a wide variety of companies (Table 4.5). Incumbent manufacturers such as Nel Hydrogen, John Cockerill, thyssenkrup nucera, PERIC and ITM Power are announcing expansions of their existing capacities, which in many cases are further expansions of recently built facilities. In addition, traditional fuel cell manufacturers such as Plug Power and Bloom Energy have also recently entered the electrolyser business, making use of their expertise in the manufacturing of several common components of polymer electrolyte membrane (PEM) fuel cells (Plug Power) and solid oxide fuel cells (Bloom Energy) (Bloom Energy, 2021; Plug Power, 2021a). Part of these expansions are expected to happen through joint ventures with new partners. This is the case for John Cockerill, which has established a joint venture with Jingli to develop its first manufacturing site in China (John Cockerill, 2019) and announced a partnership

with Greenko Group to expand its manufacturing in India (John Cockerill, 2022). Similarly, Plug Power has joined forces with Fortescue Future Industries to build a 2-GW manufacturing site in Australia (Plug Power, 2021b). These manufacturers account for more than 60% of the global project pipeline to 2030.

Companies from other sectors have also announced plans to manufacture electrolysers. This is the case for some of the top global manufacturers of solar PV panels, such as LONGi and Sungrow (which entered the electrolyser business in 2021); the State Power Investment Corporation in China, which plans to build 10 GW of electrolyser manufacturing capacity by 2027; and Topsoe, a Danish catalysis and process technology developer that recently reached a final investment decision to build a solid oxide electrolyser manufacturing site (Bloomberg, 2021; Topsoe, 2022).

Electrolyser manufacturing today is highly concentrated in China and Europe, which together account for two-thirds of global manufacturing capacity. While these two regions are expected to maintain a prominent role in the manufacturing of electrolysers, their shares are anticipated to fall to around 25% each by 2030 (although this drop may be less pronounced, as one-fifth of announced expansions have not yet been assigned specific locations and part of this capacity could be deployed in Europe and China). Regions that do not currently have manufacturing capacity in operation and expect to deploy new capacity include the Middle East, with more than 1% of global manufacturing capacity expected to be installed there in 2030, and Australia, where a factory under construction is expected to give the country a 2% share. As electrolyser manufacturing is expected to be located close to demand centres and a significant number of global announcements are not linked yet to a specific location, the adoption of policies to boost renewable hydrogen production could modify this picture as we approach 2030.

Table 4.5 Announced expansion plans of key electrolyser manufacturers

Manufacturer	Company HQ	Manufacturing capacity			
		Manufacturing location	Type of electrolyser	Today (GW)	2030* (GW)
Traditional and new electrolyser manufacturers					
thyssenkrupp nucera	Germany	Globally	Alkaline	1	5
Nel Hydrogen	Norway	Norway	Alkaline	0.5	2
		United States	PEM	<0.1	<0.1
		Other/unspecified	Alkaline	-	8
John Cockerill	Belgium	China	Alkaline	0.5	2
		India	Alkaline	-	2
		Europe	Alkaline	-	2
		Other/unspecified	Alkaline	-	2
ITM Power	United Kingdom	United Kingdom	PEM	0.2	1.5
		Other/Unspecified	PEM	-	3.5
McPhy	France	Europe	Alkaline	0.3	1.3
HydrogenPro	Norway	China	Alkaline	0.3	0.3
		Other/Unspecified	Alkaline	-	5
Ohmium	United States	India	PEM	0.5	2
Sunfire	Germany	Europe	Alkaline	0.04	1
Traditional fuel cell manufacturers					
Plug Power	United States	United States	PEM	0.5	1.5
		Australia	PEM	-	2
		Other/Unspecified	PEM	-	1
Siemens Energy	Germany	Germany	PEM	0.25	0.25
		Europe	PEM	-	3
Bloom Energy	United States	United States	SOEC	1.5	2
New market entrants					
LONGi	China	China	Alkaline	0.5	5
Sungrow	China	China	Alkaline	0.5	1
Topsoe	Denmark	Denmark	SOEC	-	5
Remaining current capacity and other announced expansions				4	>40

*Values represent total expansions announced to 2030, although in most cases the expansions have been announced for an earlier year than 2030.

Notes: HQ = headquarters; PEM = proton exchange membrane; SOEC = solid oxide electrolyser cell.

Source: IEA analysis based on manufacturer announcements and personal communications.

Regional policy and market developments

In **Europe**, the main drivers of electrolysis industry expansion are policy targets for deployment and the ambition of companies there to achieve commercial leadership in the sector. The targets for electrolysis deployment in 2030 in Europe are 49-90 GW, or 30-50% of aggregate global targets, even though the region accounts for less than 10% of global hydrogen demand today (IEA, 2022e). REPowerEU includes a target of producing 10 Mt of hydrogen using electrolysis within EU member states and importing another 10 Mt of renewable hydrogen by 2030. This would equate to 65-80 GW of electrolysis capacity, significantly boosting the 44-GW target of the Fit for 55 package that was announced in July 2021 (European Commission, 2022a). To support this objective, the European Commission signed a joint declaration in May 2022 with electrolyser manufacturers to increase EU manufacturing capacity tenfold to 25 GW per year by 2025. The declaration outlines a series of actions for the European Commission, including establishing a supportive regulatory framework, facilitating access to financing and promoting efficient supply chains (European Commission, 2022d). In April 2022, the United Kingdom launched its Energy Security Strategy, which targets low-emission hydrogen production of 10 GW by 2030 (doubling the aim of its earlier National Hydrogen Strategy), with at least half being electrolytic hydrogen (United Kingdom, HM Government, 2022).

Most of the world's largest electrolyser manufacturers are based in Europe, including thyssenkrupp nucera, Nel Hydrogen, ITM Power, McPhy and Siemens, and have a long history of technological leadership that governments in the region hope to leverage to facilitate deployment across the globe. European governments are also adopting policies to support the creation of electrolyser manufacturing capacity. The European Commission agreed to include hydrogen in the IPCEI scheme, which allows projects validated by both EU member states and the Commission to receive public support beyond the usual boundaries of state aid rules, and in 2022, 15 member states received approval to provide up to EUR 5.4 billion (around USD 6 billion) in public funding for 41 hydrogen technology value chain projects, 21 of which involve electrolysis technologies (European Commission, 2022e) The German government has been particularly active with the H2Giga flagship project (Germany, BMBF, 2021), which aims to mass produce electrolysers to scale up hydrogen production, and in 2021 it launched a programme to provide financial support for international renewable hydrogen projects and promote the use of German technology abroad (Germany, BMWK, 2021). It is unlikely that this strategy will allow electrolyser manufacturers in Europe to focus on exports, as trading large electrolyser systems is difficult and costly. However, it could result in the European deployment of manufacturing capacity for subcomponents (such as stacks), which can be more easily traded to globally distributed assembly sites. The first priority of the French National Strategy for Decarbonised Hydrogen is to develop an electrolyser manufacturing

industry in the country, and the French government has announced its intention to allocate EUR 1.5 billion to an IPCEI involving electrolyser manufacturing (France, Ministère de la Transition énergétique, 2020).

China is the world leader in electrolyser manufacturing, with almost its entire production being alkaline electrolysers. Its electrolysers cost significantly less than those of the United States or Europe thanks to lower labour costs and a generally more mature material and component supply chain, most of which is locally based. This cost advantage is attracting international manufacturers, which have begun to buy Chinese manufacturing companies and have announced plans to deploy larger manufacturing capacities in China. The joint venture between John Cockerill and Jingli now has 500 MW per year of manufacturing capacity, with plans to reach 2 GW per year of manufacturing capacity in China (John Cockerill, 2019). In 2021, Cummins Enze (a joint venture between Cummins and SINOPEC) started construction of a manufacturing site in Guangdong Province with an expected capacity of 500 MW per year (scalable to 1 GW) (Cummins, 2021).

Access to cheap renewable electricity is also attracting interest in low-emission hydrogen production using electrolysers in China, particularly to deal with curtailment and bottlenecks in the electricity grid since hydrogen provides a means of storing and transporting renewable energy from regions with abundant resources (such as Inner Mongolia, Xinjiang or the coastal regions of Fujian and Guangdong) over thousands of kilometres to inland regions with less renewable energy potential and high demand for hydrogen in industrial clusters (Shaanxi, Chongqing) (IEA, 2021). This interest began to grow later than in other regions, but the number of projects is increasing rapidly, partly in response to policy action, with most of the announcements occurring in the last couple of years. The government's Hydrogen Industry Development Plan includes a target to produce 100 000-200 000 tonnes of renewable hydrogen by 2025 (Energy Iceberg, 2022), a level that is likely to be surpassed since projects in operation, in construction and under development already amount to almost 250 000 tonnes per year (IEA, 2022e). Some provinces also have targets for renewable hydrogen production, and occasionally they even surpass the national target, such as Inner Mongolia's goal of 500 000 tonnes per year by 2025 (Argus, 2021). This growing interest in renewable hydrogen production, along with the low manufacturing costs of Chinese electrolyser manufacturers, is expected to trigger a considerable expansion in electrolyser manufacturing capacity in the country.

The **United States** has the second-largest electrolyser manufacturing capacity after China, with the major companies being Plug Power, Bloom Energy and Nel Hydrogen. Apart from recently announced expansions that will boost Plug Power's capacity to 1.5 GW per year and Bloom Energy's to 2.5 GW per year, activity has been very limited. However, the situation is beginning to change thanks to recent federal government policies, primarily the IRA, that include several financial

incentives for low-emission hydrogen deployment, including the Clean Hydrogen Production Tax Credit (United States, Congress, 2022). This tax credit provides an incentive relative to the carbon intensity of hydrogen production; it can reach as much as USD 3/kg of hydrogen, which is expected to ensure the financial feasibility of a significant number of projects. This would boost electrolyser demand in the United States, which will most likely attract investment in electrolyser manufacturing. Just two months after the bill was signed, Cummins announced plans to build a new electrolyser manufacturing site in Minnesota with a capacity of 500 MW per year, scalable to 1 GW (Cummins, 2022).

The other main government measure to encourage low-emission hydrogen uptake is a USD 7-billion call launched in September 2022 (as part of a larger USD 8-billion programme) for the deployment of six to ten hydrogen hubs – which will be selected in spring 2023 – to be implemented by the US Department of Energy’s Office of Clean Energy Demonstrations (United States, DOE, 2022c). In addition, the US government announced funding of USD 1 billion for a Clean Hydrogen Electrolysis Program to reduce production costs, and USD 500 million for Clean Hydrogen Manufacturing and Recycling Initiatives to support equipment manufacturing and domestic supply chains (The White House, 2022). Funding for both programmes (a total of USD 9.5 billion) will come from the Infrastructure Investments and Jobs Act (IIJA). The Defence Production Act of June 2022 granted the government authority to invest in companies that can manufacture and install key energy technologies, including electrolysers (United States, DOE, 2022d).

Cross-cutting equipment

In addition to the specialised clean energy technologies of the selected supply chains discussed above, some equipment is also mass-manufactured and is common to several of them. Such equipment includes compressors, pumps, fans, heat exchangers, separation columns and storage tanks, and is required for the production, distribution and storage of fluids and gases. This cross-cutting equipment is needed mainly for large-scale, site-tailored clean energy technologies. The manufacturing of these devices can benefit from synergies with other industries in which this equipment has been used for decades, notably oil and gas, chemicals and power generation, leveraging access to a large and diverse pool of suppliers located in different regions with well-established manufacturing facilities and supply chains.

Compressors and pumps, which are widely used in the oil and gas industry, will be required along CO₂ and hydrogen supply chains. As demand for natural gas compression falls towards 2030, existing gas compressor manufacturers could adjust their manufacturing facilities and operating workforce to CO₂ and hydrogen compressor manufacturing. Equally, chemical absorption columns, which are part

of state-of-the-art CO₂ capture systems, are used across a wide range of applications today, such as acid gas removal, chemicals synthesis, ethanol dehydration and flue gas desulfurisation. A leading manufacturer, Sulzer, has 100 000 distillation and absorption columns currently in operation. Chemical absorption columns to meet overall CO₂ capture needs across all CCUS applications in 2030 would only incur a few percentage points' increase relative to this particular fleet today, while use in other applications such as flue gas desulfurisation is expected to contract as coal-based power is phased out.

Recognising the potential for these sectoral technology spillovers, some core equipment will need to be adapted, either to a new working fluid (e.g. CO₂) or to a different scale. For DAC, large fans will be needed to move air in very large facilities, and the manufacturing of new air contactors and collectors, in the case of solid-DAC technology design (IEA, 2022f), will need to be scaled up. The supply chain for large-scale centrifugal CO₂ compressors is not yet established and some existing CCUS facilities have experienced procurement times of three to four months. Nonetheless, this is significantly shorter than lead times typically associated with permitting, financing and installing these systems.

Installation of large-scale, site-tailored technologies

Large-scale, site-tailored technologies are usually individually designed and manufactured to fit specific processes and local conditions. These technologies require site-specific engineering and installation to a greater degree than the mass-manufactured technologies discussed above, as they cannot be directly manufactured, though their components can be. Of the supply chains analysed in this report, natural gas-based hydrogen production with CCS (part of the low-emission hydrogen supply chain), DAC, BECC and low-emission synthetic hydrocarbon fuel synthesis (part of the low-emission synthetic hydrocarbon fuel supply chain) are technologies categorised as site-tailored.

These technologies are not fully commercial yet; many of the facilities currently operating or under construction are first- or second-of-a-kind projects, often backed by public funding. They require wide-ranging expertise and large upfront investments, so are often developed by industrial consortia. The installation step for these technologies is particularly critical, with lead times typically much longer than for mass-manufactured technologies, mainly due to the time it takes to secure funding and permits, and then to assemble the technologies on a large scale.

Lead times from the first feasibility studies to plant commissioning are typically around five years, of which around three are just to reach the final investment decision (FID). For large-scale, site-tailored technologies, plant elaboration needs to be aligned with infrastructure development (for fuel or CO₂ transport). This

cross-chain sequencing can cause project lead times to increase: for example, Canada's Alberta Carbon Trunk Line, a 240-km CO₂ pipeline with a capacity of up to 15 Mt of CO₂ per year finally came on line in 2020, a full ten years after the project was announced, due to differences in the timing of specific project segments. Large-scale facilities can also take years to reach nominal operating capacity, with little flexibility to adjust output without additional investment in the event of higher demand. Efforts to shorten lead times (for instance by reducing permitting times) will be needed to make sure these technologies scale up to the level required by the end of the decade.

The planned deployment of large-scale, site-tailored technologies currently falls short of that projected in 2030 in the NZE Scenario, despite a surge in project announcements in the past two years. While over 230 CCUS projects involving various hydrogen, DAC and BECC applications have been announced since the start of 2021,³³ planned capture capacity by 2030 would meet only one-third of projected needs for hydrogen production using gas with CCS, 15% for low-emission synthetic hydrocarbon fuels and 20% for BECC. This is in large part related to uncertainty about future climate policies and their impact on demand for CO₂ management services and low-emission fuels, which is impeding financing and investment. Smooth permitting and financing also dependent strongly on the development of CO₂ transport and storage infrastructure (see Chapter 5), with projects targeting CO₂ storage taking on average twice as long to complete than projects that involve CO₂ utilisation. DAC is currently on track for required deployment in 2030 under the NZE Scenario, though many announced DAC projects are at very early stages of development (without an assigned location, which will be finalised depending on how regional climate policy environments evolve) and still need policy support to achieve a positive FID.

Boosting production capacity for large-scale, site-tailored technologies to the degree envisioned in the NZE Scenario would require a 60% increase in investments compared with what has already been announced. Cumulative global investment would need to rise by around USD 150 billion (in 2021 US dollars) by 2030, in addition to the roughly USD 260 billion associated with already-announced projects,³⁴ with DAC accounting for around three-quarters of this spending (Figure 4.13). In percentage terms, the investment gap is widest for low-emission synthetic hydrocarbon fuel production. The regional breakdown of announced investments is relatively diverse, with North America and Europe accounting for around half of the total.

³³ This includes 1PointFive and Carbon Engineering's announcement to deploy 100 large-scale DAC facilities by 2035 (Oxy, 2022a).

³⁴ Only a few announced projects had reached FID as of December 2022.

Figure 4.13 Announced global cumulative investment in large-scale, site-tailored clean energy technologies by region/country and that required to meet demand in 2030 in the NZE Scenario, 2022-2030

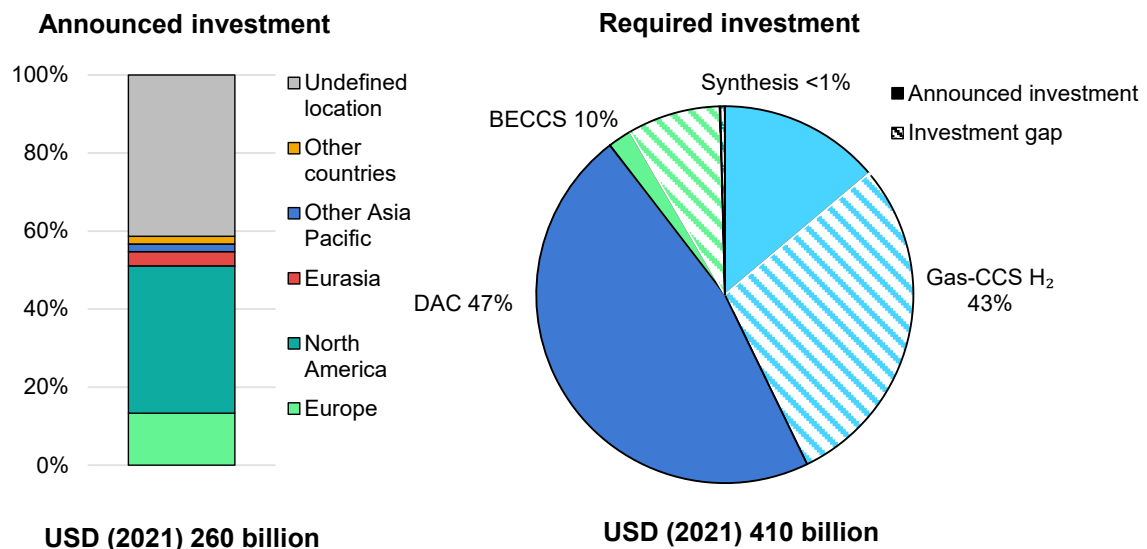

IEA. CC BY 4.0.

Notes: Gas-CCS H₂ = natural gas-based hydrogen production with CCS; DAC = direct air capture; BECC = bioenergy with CCUS. "Synthesis" refers to production of low-emission synthetic hydrocarbon fuels. "Required investment" is for projected deployment to 2030 in the NZE Scenario.

Boosting capacity to manufacture large-scale, site-tailored technologies to the degree projected in the NZE Scenario would require a 60% increase in planned investment over 2022-2030.

The pace of growth in large-scale, site-tailored technologies required to be on track for the NZE Scenario peaks this decade even though deployment by 2030 remains modest, reflecting the current very low levels of deployment. However, the rate of capacity expansion must be sustained beyond 2030, averaging around 25% per year for DAC and around 35% for low-emission synthetic hydrocarbon fuels in the 2030s (natural gas-based hydrogen with CCS and BECC growth rates are closer to 10%).

Natural gas-based hydrogen with CCS

Reforming of natural gas in conjunction with CCS is an important source of low-emission hydrogen production in the NZE Scenario, meeting around 20% of global hydrogen needs in 2030 and 25% in 2050. Only around 0.4 Mt per year is currently produced in this manner, with another 0.3 Mt coming from coal- and oil-based CCS routes, and less than 100 kt from electrolysis. Steam methane reforming (SMR) with CO₂ capture for hydrogen production has so far been deployed mostly as a retrofit solution in refineries and fertiliser plants in North America, the first CO₂ capture unit retrofit dating back to the 1980s.

Hydrogen production is the main source of CO₂ capture after natural gas processing, as the production process emits a high-concentration CO₂ stream, which keeps the cost down. Today, around 11 Mt CO₂, or 25% of total CO₂ capture capacity, is captured from hydrogen production and 4 Mt CO₂ comes from SMR plants. For hydrogen production to deliver emissions reductions, captured CO₂ must be permanently stored; upstream CO₂, methane and nitrous oxide emissions from natural gas extraction and supply must be minimised; and capture rates must be high. Today, only the three SMR units of the Quest project in Canada capture CO₂ for permanent storage (Alberta, Department of Energy, 2020), while other projects use captured CO₂ for enhanced oil recovery (EOR).³⁵

Expansion plans and the gap with the net zero trajectory

Low-emission hydrogen and ammonia production are continuing to incite new CCS developments. Close to one-third of CO₂ capture projects under construction or in planning involve hydrogen or ammonia production across a range of applications, including dedicated production, refineries, fertiliser and iron and steel. If all announced projects were realised, hydrogen production capacity from gas reforming with CCS would increase more than twentyfold from around 0.5 Mt per year in 2021 to 11 Mt per year by 2030, through both SMR and autothermal reforming (ATR) processes. This is still 22 Mt per year short of the nearly 33 Mt of production capacity needed in 2030 in the NZE Scenario (Figure 4.14). Moreover, some projects (Table 4.6) under development will need further policy and financial support to come to fruition. To date, very few projects have reached FID, and the recent surge in gas prices, especially in Europe, could lead to delays or cancellations of planned projects.

Since most operating plants are capital-intensive first-of-a-kind facilities, project lead times have historically been long, ranging from 1.5 to 9 years, with an average of around 4 years. Permitting and financing often constitute an important hurdle, taking on average almost as long as construction. Projects that require the construction of new CO₂ management infrastructure for CO₂ transport and storage tend to have longer lead times. New hydrogen facilities are increasingly being sited close to industrial clusters. These clusters can be a source of hydrogen demand and can create opportunities to share construction costs for CO₂ transport and storage infrastructure with other emitters, which could cut overall low-emission hydrogen project lead times once this infrastructure is in place. About half of gas-based hydrogen production with CCS facilities are being developed as part of CO₂ transport and storage hubs catering for multiple industrial sources.

³⁵ Most CO₂ injected for EOR is retained in the reservoir over a project's lifetime, but additional monitoring and verification are essential to confirm that the CO₂ has been permanently stored (IEA, 2015).

Figure 4.14 Capacity of hydrogen production from natural gas with CCS by country/region according to announced projects and in the NZE Scenario

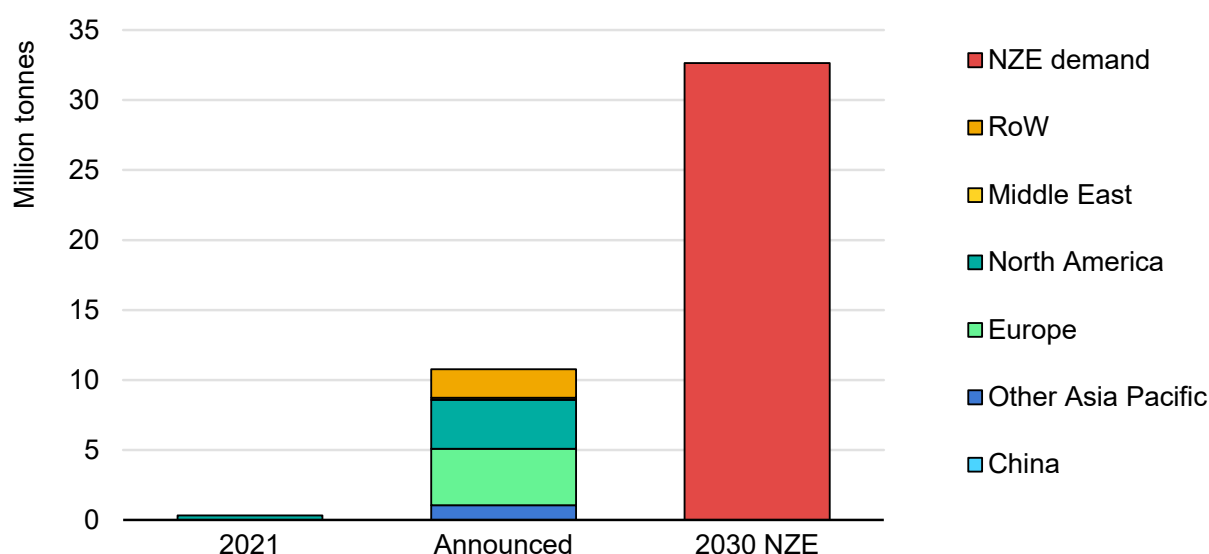

IEA. CC BY 4.0.

Notes: RoW = rest of world; NZE = Net Zero Emissions by 2050 Scenario. Announced capacity includes existing capacity. Covers projects for which a start year for operation has been disclosed (those at very early stages of development, such as those in which only a co-operation agreement among stakeholders has been announced, are not included).

Announced gas-based hydrogen production with CCS meets only one-third of NZE Scenario requirements in 2030.

Table 4.6 Planned capacity expansions of selected companies to produce hydrogen from natural gas with CCS

Company	Company HQ	2021	2030
kt per year			
Shell	Netherlands	98	135
Air Products	United States	88	870
Koch Nitrogen Company, Chaparral Energy	United States	68	68
Nutrien	United States	29	29
PCS Nitrogen, Denbury (EOR)	Canada	24	24
Air Liquide	France	10	108
Vertex Hydrogen (Essar Oil, Progressive Energy)	United Kingdom	0	770
Equinor	Norway	0	333
Bakken Energy	United States	0	279
Equinor, SSE Thermal	Norway	0	270
H-vision consortium (Deltaqinqs, Air Liquide, BP, Gasunie, Port of Rotterdam, Onyx Power, Shell, Uniper, Royal Vopak, ExxonMobil, EBN, Equinor)	Various	0	264
Kellas Midstream	United Kingdom	0	225

Company	Company HQ	2021	2030
		kt per year	
Suncor Energy, Atco	Canada	0	195
ADNOC	UAE	0	162
Uniper, Shell	Netherlands/Germany	0	162
Aker Carbon Capture, Equinor	Norway	0	49

Notes: Include only low-emission hydrogen capacity of projects with an announced timeline.

Regional policy and market developments

North America is responsible for almost all hydrogen production capacity from gas reforming with CCUS today, as well as almost one-third of the project pipeline to 2030, as new project development is being propelled by growing demand for low-emission hydrogen and hydrogen-based fuels. Historically, however, strong CO₂ demand for EOR – especially in the **United States** – was the primary driver for the development of CO₂ capture technology, dating back to the 1980s (the first fertiliser plant was retrofitted with CCUS in 1982). In 2021, the United States accounted for more than half of global gas-based hydrogen production capacity with CCUS.

The 45Q tax scheme, introduced in the United States in 2008 (at that time providing USD 10 per tonne [t] of CO₂ utilised for EOR, and USD 20/t CO₂ stored), has been the main policy support for CCUS, prompting the retrofitting of two SMR facilities with CCUS in 2013 (a PCS Nitrogen fertiliser plant and an Air Products plant) (United States, DOE, 2018; Nutrien, 2020). The 45Q tax credit amount has risen progressively; most recently, the Inflation Reduction Act (IRA) boosted it to USD 60/t CO₂ used and USD 85/t CO₂ stored and also extended construction deadlines to 2033 (United States, Congress, 2022). This policy continues to support project development, with more than 20 new SMR and ATR facilities targeting CO₂ capture in upcoming years, including new ammonia plants developed by established companies such as Air Products and by new market entrants such as Bakken Energy.

In **Canada**, a well-established CCUS legal and regulatory framework, as well as government funding for CCUS in Alberta and in the rest of Canada, led to commissioning of the flagship Shell-operated Quest project in 2015 (Alberta, Department of Energy, 2020) and the ACTL shared transport and storage infrastructure project in 2020 (Alberta, Department of Energy, 2019). Both projects involve hydrogen production. In Alberta, the sector is benefiting from both a carbon storage hub strategy to reduce CO₂ transport and storage costs and a provincial Hydrogen Roadmap, which targets low-emission hydrogen, ammonia and methanol production to decarbonise local industry and provide supplies for export to the rest of North America, Asia Pacific and Europe (Alberta, Government of Alberta, 2021).

In **Europe**, only one large-scale gas-based hydrogen plant with CO₂ capture is currently in operation: France's Air Liquide demonstration plant at Port-Jérôme. Government-funded industrial decarbonisation programmes, such as the United Kingdom's industrial cluster competition and targeted funding for projects through the European Innovation fund, are driving gas-CCUS hydrogen project development, and Europe could account for nearly 40% of total capacity by 2030. These projects are often led by large industrial consortia including oil companies that have expanded their activities to CCUS (e.g. Equinor, Shell, BP and ADNOC), as well as by new capture- or storage-as-a-service companies (e.g. Aker Carbon Capture, Carbon Clean and Storegga), existing hydrogen companies (such as Air Liquide) and new market entrants in hydrogen production (e.g. Vertex Hydrogen and Uniper). But very few of these projects had reached FID as of October 2022. It remains unclear whether recent natural gas price hikes might delay FIDs planned for 2023, including for the Botlek refinery at Rotterdam, the Barents Blue ammonia project in Norway, Project Cavendish, Hynet and Saltend in the United Kingdom, and the Exxonmobil refinery at Antwerp.

In the **United Arab Emirates**, government and corporate-level net zero objectives, and the opportunity to create a low-emission hydrogen and ammonia hub are spurring deployment of gas-based hydrogen production with CCUS. The Abu Dhabi National Oil Company plans to expand low-emission fuel production in the area, with a new ammonia facility planned for 2025 (ADNOC, 2021). A recent MOU signed with Mitsui and ENEOS, to establish clean-hydrogen supply chains between the United Arab Emirates and Japan, could also pave the way to new investment (Mitsui, 2022).

Development is also gaining speed in the **Asia Pacific** region, with hydrogen projects announced in Australia, Japan, Indonesia, India and Korea. In Australia, funding has been made available to develop eight hydrogen hubs (CSIRO, 2022). This stimulus, coupled with strong policy support for CCUS (such as the Long-Term Emissions Reduction Plan and the Emissions Reduction fund, which allows CCUS projects to trade carbon credits) and well-established CCUS legal and regulatory frameworks, has led to the announcement of six gas-based hydrogen or ammonia plants with CCUS, one of which could be operational as early as 2025. In February 2022, Indonesia released a legal and regulatory draft framework for CCUS, the first one in southeast Asia. The country is also collaborating with Japan on low-emission ammonia, as part of an MOU signed in January 2022 (Japan, METI, 2022). In China, a medium-term plan for establishing a low-emission hydrogen industry was released in March 2022. However, most hydrogen with CCUS developments are likely to be coal-based given the limited availability of natural gas in the country.

Direct Air Capture

Expansion plans and the gap with the net zero trajectory

DAC technologies capture CO₂ directly from the atmosphere. Current DAC deployment is extremely limited, with only 17 plants operating worldwide (in Europe, the United States and Canada), capturing less than 10 kt CO₂ per year (IEA, 2022f). Only a few commercial agreements are in place to sell or store the captured CO₂. All the operating plants are small-scale, with the largest one capturing 4 000 t CO₂/year in Iceland (Climeworks, 2022). Most of the plants commissioned to date are being operated for testing and demonstration purposes only, with only two plants storing the captured CO₂ permanently in geological formations. Three DAC projects are currently under construction, with the largest expected to come online in 2024 in Iceland (nominal capture capacity of 36 kt CO₂/year) and in the United States (initial nominal capture capacity of 500 kt CO₂/year, with plans to scale up to as much as 1 000 kt CO₂/year).

With some of these projects, developers are offering commercial services to individuals and companies willing to pay a recurring subscription fee to have CO₂ removed from the atmosphere and stored underground on their behalf. These carbon removal services, which are proving extremely popular, are offered exclusively through the voluntary carbon market and are being purchased mostly by companies to meet their own climate targets. Their popularity stems mainly from their very high removal potential (IPCC, 2022) when associated with geological storage. Most are oversubscribed due to the very limited installed operating capacity available at present.

Fast-growing demand for air-captured CO₂, for both carbon removal and low-emission synthetic hydrocarbon fuel production, is translating into several announcements for new, larger plants. Some of the largest projects under development are in the United States and the United Kingdom (with nominal capture capacity in each case of between 0.5 and 5 Mt CO₂/year) (Storegga, 2021; Carbon Capture, 2022; Carbon Engineering, 2021a). Plans for more than 110 DAC facilities are now at various stages of development.³⁶ If all were to advance, DAC deployment would reach NZE Scenario requirements for 2030 (Figure 4.15). Lead times for DAC plants range from two to six years depending on the technology, suggesting that NZE Scenario deployment could be achieved with adequate policy support.

Based on announced projects in advanced development, North America is expected to deploy substantial DAC capacity by the end of this decade. Almost 40% of global announced capacity to be operational in 2030 is in the United States

³⁶ Including 1PointFive and Carbon Engineering's announcement to deploy 100 DAC facilities by 2035, each with a capture capacity of up to 1 Mt CO₂ per year.

(including the DAC-1 project and the Matagorda County eFuels project, both in Texas). A number of projects have also been announced in Europe, but they only amount to less than 5% of global planned capacity for 2030. The United Kingdom is leading the way with two sizeable DAC developments – the North-East Scotland DAC project and the AtmosFUEL project (Carbon Engineering, 2021c; 2021d). Other major undertakings include the Norsk e-fuel project and the Kollsnes DAC project in Norway and the Mammoth project in Iceland (Norsk e-fuel, 2022; Climeworks, 2022).

Over half of announced DAC capacity for 2030 (currently in early development stages) has not yet been linked to a specific location, with project developers awaiting favourable regulations before finalising their expansion plans. In November 2022, 1PointFive and Carbon Engineering announced plans to deploy 100 large-scale DAC facilities (each with a capture capacity of up to 1 Mt per year) by 2035 (Oxy, 2022a), 30 of which will be in the United States owing to the IRA’s recent increase to the 45Q tax credit. Remaining projects are expected to be deployed mostly in China and Southeast Asia (Oxy, 2022b), with some likely to materialise in Europe and the Middle East (which has recently shown interest in DAC testing [Climeworks, 2021]). Multiple criteria will be considered for the finalisation of locations, including demand growth for carbon removal credits or low-carbon fuels, public policies and incentives, and technoeconomic conditions such as the availability of geological storage and low-carbon energy sources.

Figure 4.15 Direct air capture capacity by country/region for use and storage according to announced projects and in the NZE Scenario

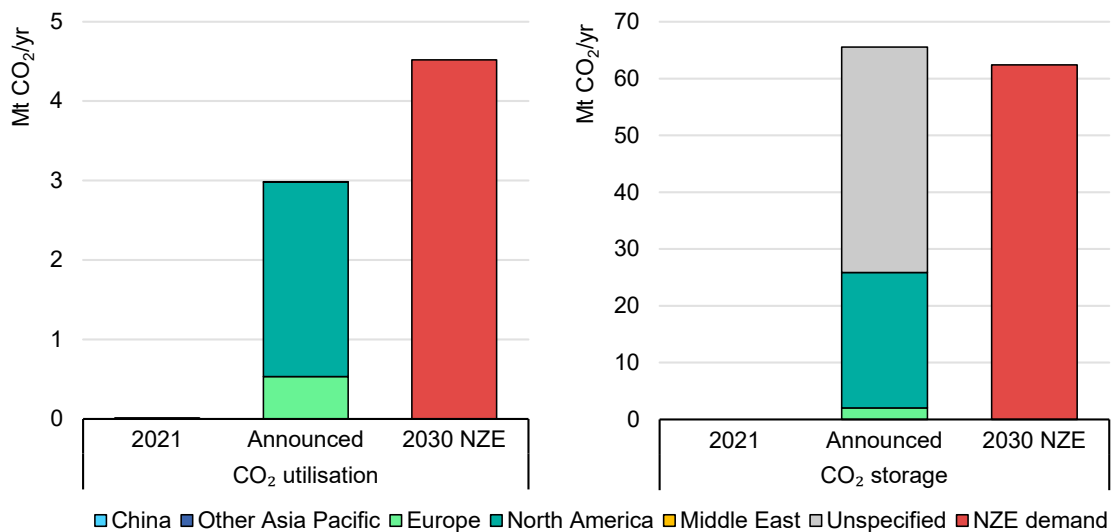

IEA. CC BY 4.0.

Notes: NZE = Net Zero Emissions by 2050 Scenario. Dedicated storage only. Announced capacity includes existing capacity. “Unspecified” refers to 69 of 100 facilities recently announced by 1PointFive and Carbon Engineering, for which locations have not yet been finalised. The fate of the captured CO₂ (storage or use) has not been disclosed.

Announced DAC technology deployment is roughly in line with NZE Scenario projections for 2030, though stronger policy support is needed to ensure projects proceed.

A growing number of companies are entering the DAC business, all trying to reach the demonstration phase with their proprietary technologies, with some close to pre-commercial demonstration (Table 4.7). While DAC technology manufacturers initially developed their intellectual property independently, they are now beginning to collaborate with synthetic fuel producers to test and operate their technologies at larger scales. Examples include the Norsk e-fuel project, the Merritt Electrofuels Project and the Haru Oni demonstration project, all of which aim to produce synthetic hydrocarbon fuels from electrolytic hydrogen and CO₂ captured from multiple sources including bioenergy production, industrial applications and the air (Norsk e-fuel, 2022; Carbon Engineering, 2021b; Haru Oni, 2022).

Table 4.7 Direct air capture expansion projects of selected companies

Company	Company HQ	2021	2030
kt CO ₂ /year			
Climeworks	Switzerland	5.0	1 100
Global Thermostat	United States	1.5	1 500
Carbon Engineering	Canada	0.4	59 000
CarbonCapture	United States	-	5 000

Note: HQ=headquarters. 2021 and 2030 values refer respectively to estimated operating capacity and planned operating capacity.

Regional policy and market developments

Countries and regions that have taken an early lead in supporting DAC research, development, demonstration and deployment include the United States, the European Union, the United Kingdom, Canada and Japan. The **United States** has established a number of policies and programmes to support DAC, including the 45Q tax credit (recently increased to USD 180/t CO₂ under the IRA of 2022, with a capture threshold of as little as 1 kt CO₂/year) and the California Low Carbon Fuels Standard credit (traded at an average of around USD 180/t CO₂ in late 2021). Meanwhile, the Infrastructure Investment and Jobs Act (signed into law in November 2021) includes funding (USD 3.5 billion) to establish four large-scale DAC hubs and related transport and storage infrastructure. In **Canada** the 2022 federal budget proposed an investment tax credit for CCUS projects between 2022 and 2030, valued at around 60% for DAC projects when CO₂ is stored at an eligible permanent sequestration site (IEA, 2022g).

The **European Commission** has been supporting DAC through various research and innovation programmes, including the Horizon Europe programme and its

predecessors (i.e. the Seventh Framework programme and Horizon 2020), as well as through the Innovation Fund (launched in 2020 for the 2020-2030 decade with an initial budget of around USD 11.8 billion). Moreover, in December 2021 the European Commission released its first Communication on Sustainable Carbon Cycles, suggesting that by 2030 5 Mt of CO₂ should be removed annually from the atmosphere and permanently stored through solutions such as DAC (European Commission, 2021c). In the **United Kingdom**, in October 2021 the government set out a Net Zero Strategy aimed at achieving net zero emissions by 2050. It identifies the need for around 80 Mt of CO₂ removal by 2050 using DAC and BECC technologies (United Kingdom, BEIS, 2021).

Bioenergy with carbon capture

BECC involves the capture of CO₂ from a biogenic source, such as from plants producing biofuels, bio-based heat and power or biohydrogen, or from industrial facilities that use biomass as a fuel or feedstock. CO₂ can be either stored to provide removal or used as a carbon-neutral feedstock for low-emission synthetic fuel production. Around 2.5 Mt CO₂ per year are currently captured from biogenic sources, over 90% in bioethanol facilities – currently the lowest-cost BECC application due to the high concentration of CO₂ in the process gas stream. Around half is stored in dedicated storage, while the other half is sold, for example to greenhouses for yield enhancement or for EOR.

Expansion plans and the gap with the net zero trajectory

Bolstered by country-level net zero announcements and low-emission fuel strategies, the BECC project pipeline has grown in recent years. Close to 40 Mt CO₂/year could be captured in 2030, with around 65% from bioethanol and biodiesel plants and 35% from heat and power plants, according to publicly announced plans. While this represents a 15-fold increase from today's levels, it still falls far short of the 180 Mt CO₂/year required in 2030 in the NZE Scenario (Figure 4.16). Most of the captured CO₂ included under current plans is associated with dedicated storage, while less than 1 Mt CO₂/year is to be used for low-emission synthetic fuel production – only one-third the level projected in the NZE Scenario.

Figure 4.16 Capacity of bioenergy with CO₂ captured for use and storage by country/region according to announced projects and in the NZE Scenario

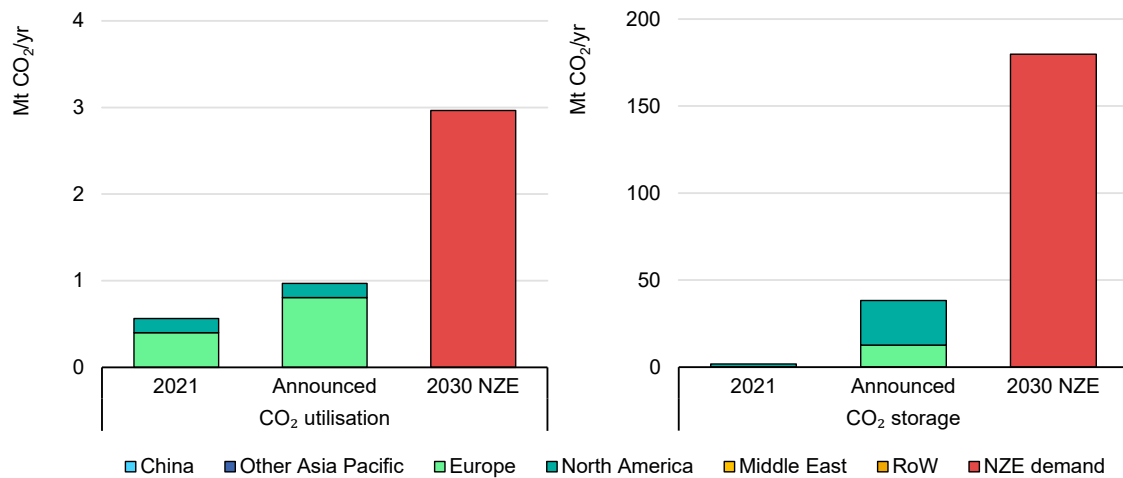

IEA. CC BY 4.0.

Notes: NZE = Net Zero Emissions by 2050 Scenario. Announced capacity includes existing capacity. Includes only large-scale projects (>0.1 Mt CO₂ per year) with an announced timeline, targeting CO₂ capture from biofuel production, heat and power plants, industrial facilities, or hydrogen production relying partly or fully on biomass. Some projects (e.g. cement or waste-to-energy facilities) also include capture of non-biogenic emissions in communicated capture capacities. When the fraction of biogenic emissions of total captured CO₂ is unknown, it is assumed that the share of biogenic emissions is 10% in cement facilities and 50% in waste-to-energy plants. CO₂ utilisation includes projects targeting low-emission synthetic fuel production. CO₂ storage includes projects targeting dedicated storage.

Announced BECC capacity amounts to only one-third of NZE Scenario requirements in 2030.

Project experience in bioethanol and biopower plants equipped with CCUS suggests that project lead times on the capture side can range from 1.5 to 6.5 years, averaging 3.5 years. However, lead times depend strongly on the application and destination of the CO₂. The only two plants involving storage that are in operation today – both bioethanol plants in the United States – took around seven years to complete (including the construction of transport and storage infrastructure). In contrast, projects involving the use of captured CO₂ were completed in less than four years. Bioethanol plants tend to involve shorter lead times than bio-based power applications. Lead times are as short as one to two years for bioethanol plants, as they only require the installation of CO₂ drying and compression units, which are less capital-intensive than full capture units. Given that current facilities are first- or second-of-a-kind, lead times will most likely shorten as deployment increases. In the United States, the lead time for retrofitting the second bioethanol facility with CCS was one year shorter than for the first. Nonetheless, investment decisions are needed in the near term for the technology to mature sufficiently to be on track for NZE Scenario deployment in 2030.

Table 4.8 Announced BECC expansion projects of selected companies

Operator/project developer	Company HQ	Technology provider	2030 (Mt CO ₂ /yr)
Summit Carbon Solutions	United States	Xebee Adsorption (compression)	8
Drax	United Kingdom	Mitsubishi (capture)	8
Illinois clean fuels	United States		6.3
Poet	United States	Navigator CO ₂ Ventures (CCUS)	5
Cory	United Kingdom		1.5
ZEROs Inc	United States		1.5
Viridor	United Kingdom	Aker Carbon Capture (capture)	0.95
Stockolm Exergi	Sweden	CO ₂ Capsol (capture)	0.7
White Energy	United States	Oxy Low Carbon Ventures (storage)	0.7
Amager-Bakke	Denmark	Babcock & Wilcox (capture, solvent)	0.5
Velocys	United States	Oxy Low Carbon Ventures (storage)	0.5
Vestforbrænding	Denmark		0.45
Aemetis	United States	Koch (capture)	0.4
RedCar Energy	United Kingdom		0.4
Hafslund Oslo Celsio	Norway	Shell (capture), Equinor (storage), Technip Energies (EPC)	0.4
Clean Energy Systems	United States	Clean Energy Systems (capture), Schlumberger New Energy (storage)	0.3
Midwest AgEnergy Group	United States	Carbon America Developments	0.2
Växjö Energi	Sweden	Midroc Group	0.18

Regional policy and market developments

The vast majority of BECC capacity will still be based in North America and Europe by the end of this decade according to current plans (Table 4.8). In the **United States**, the sector has benefitted from supportive policies covering bioenergy, low-emission fuels and CCUS. For example, the 2018 Farm Bill established a variety of new programmes to help develop and deploy a wide range of carbon removal technologies (United States, Congress, 2018), while the Energy Act of 2020 contains several provisions to promote them (United States, Congress, 2020). In addition, the IRA provides several BECC incentives, including the expansion and extension of the 45Q tax credit, the Second-Generation Biofuel tax credit, and the Clean Fuels Production tax credit (United States, Congress, 2022). As first-generation bioethanol plants do not currently meet low-emission criteria to qualify for the IRA tax credits, the IRA may serve to promote CCUS deployment at these plants.

The policy landscape has resulted in the United States having the largest operating BECC project to date, the Illinois Industrial CCS Project, which has been capturing 1 Mt CO₂ per year for permanent storage in a deep geological formation since 2017 (ADM, 2020). The Red Trail Energy bioethanol CCS project also recently came on line in North Dakota (Upstream, 2021). The 45Q credit continues

to drive deployment, with around 40 bioethanol facilities planned to start capturing CO₂ before 2025, totalling around 15 Mt of biogenic CO₂ capture capacity. This includes roughly 30 facilities that are part of the Midwest Carbon Express project, led by a new CCUS project developer, Summit Carbon Solutions (Summit Carbon Solutions, 2021).

In **Europe**, interest in BECC has been spurred mostly by corporate and country-level net zero announcements and carbon removal policies. In total, there are plans to capture around 10 Mt of biogenic CO₂ from heat and power plants, with around 80% from dedicated bioenergy heat and power plants and 20% from waste-to-energy plants. In the European Union, while carbon removal is not credited under the EU Emissions Trading System, the first Communication on Sustainable Carbon Cycles, released by the Commission in December 2021, suggests that 5 Mt of CO₂ should be removed annually by 2030 from the atmosphere and permanently stored using technologies such as BECC (European Commission, 2021b).

In January 2021, the Swedish government tasked the Swedish Energy Agency with designing a support scheme for BECC, to be implemented in 2023 as a reverse auction (Sweden, Swedish Energy Agency, 2022). In the United Kingdom, the Net Zero Strategy set out a 5 Mt CO₂ per year target for engineered carbon removal through BECC and DAC by 2030, with the aim of achieving 80 Mt by 2050 (United Kingdom, BEIS, 2021). A public consultation on business models for removals was also launched in July 2022, with a focus on first-of-a-kind BECC power plants (United Kingdom, BEIS, 2022). The UK power station Drax, in partnership with Mitsubishi Heavy Industries (capture) and the Northern Endurance Partnership (storage), currently leads BECC deployment in Europe (Drax, 2021b). Low-emission fuel support is also partly driving BECC uptake. In Denmark, sourcing CO₂ from a bio-fired power plant for use in fuel production is being explored as part of the Green Fuels for Denmark project (Orsted, 2022), and CO₂ use is also being considered at waste-to-energy facilities in Denmark (Vestforbrænding, 2019) and Portugal (Veolia, 2022).

The first retrofitting of a large-scale biomass-fired power plant with CO₂ capture was in **Japan** in 2020 (Toshiba, 2020), although no storage site for the CO₂ has yet been identified. More recently, Pertamina announced plans to retrofit a pulp and paper mill in **Indonesia** (Marubeni, 2022).

Low-emission synthetic hydrocarbon fuels

Expansion plans and the gap with the net zero trajectory

Low-emission synthetic hydrocarbon fuels are expected to play a small but important role in decarbonising transport modes in the NZE Scenario (see Box

4.4), mainly in aviation because alternative solutions pose significant technical challenges and synthetic fuels meet one-quarter of the sector’s final energy consumption in 2050. Low-emission Fischer–Tropsch (FT) synthetic hydrocarbon fuel production is currently limited to a few pilot plants in Europe, with total production capacity of around ten barrels per day in 2021, using 1 800 t CO₂. Much larger fossil-based FT plants have been operated by large engineering and oil and gas companies such as Sasol, Shell and Synfuels China for decades. Some components and competences are easily transferrable from fossil-based applications to non-fossil ones. The focus at present is on the large-scale demonstration of new components of low-emission FT synthesis, such as the reverse water-gas shift process.

Based on current announcements, planned capacity additions fall well short of NZE Scenario needs for 2030 (Figure 4.17). Around 15 projects have been announced worldwide for synthetic hydrocarbon fuel production, which would result in total capacity of over 35 000 barrels/day in 2030 (using 6 MtCO₂/year) if they are completed on time. Of these projects, roughly ten focus on FT synthesis using at least some CO₂ from BECC or DAC, accounting for around 15% of planned capacity (Table 4.9). Given that construction lead times for synthesis plants range from two to four years, NZE Scenario deployment can be achieved only with a substantial strengthening of policy support in the next few years.

Figure 4.17 Low-emission synthetic hydrocarbon fuel production capacity by country/region according to announced projects and in the NZE Scenario

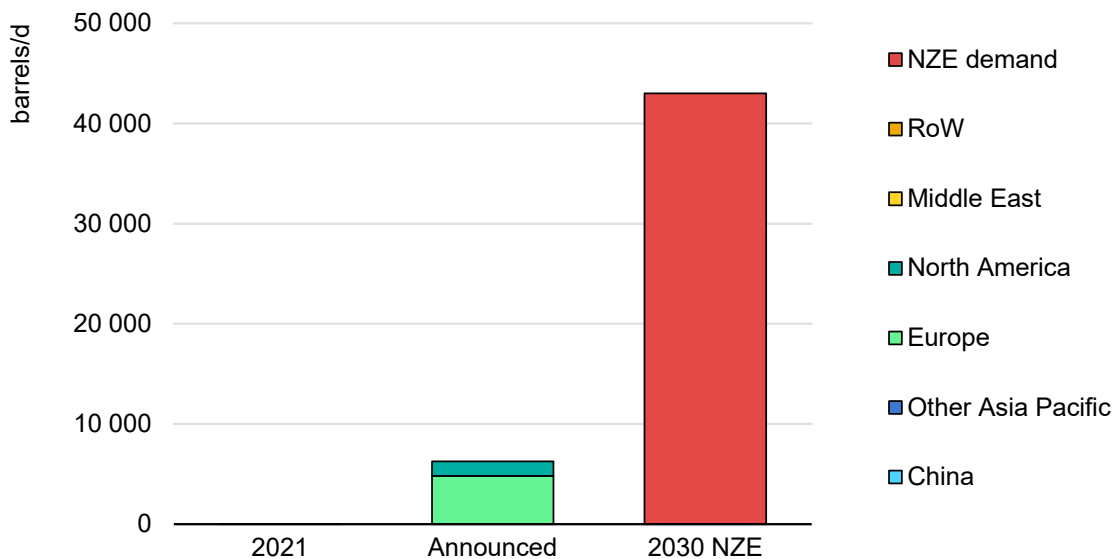

IEA. CC BY 4.0.

Notes: RoW = rest of world; NZE = Net Zero Emissions by 2050 Scenario. Announced capacity includes existing capacity. Announced capacity and 2030 NZE values include FT synthesis using atmospheric or biogenic CO₂ sources.

Announced low-emission synthetic hydrocarbon fuel production falls well short of NZE Scenario requirements for 2030.

Table 4.9 Announced low-emission synthetic hydrocarbon fuel capacity by company

Company	Company HQ	2021	2030
		Capacity (barrels/d)	
INERATEC GmbH	Germany	11	11
HIF*	Multiple locations	0	23 400
Infinium	United States	0	3 050
Sunfire	Germany	0	2 400
LanzaTech*	Multiple locations	0	2 900
Carbon Engineering	Canada	0	1 450
EDL Anlagenbau	Germany	0	1 100
Synkero	Netherlands	0	1 100
Topsoe*	Denmark	0	400
ENEOS*	Japan	0	300
Emerging Fuels Technology	United States	0	170
BP - Johnson Matthey	United Kingdom	0	50

*Companies focusing on non-FT synthesis.

Note: The Infinium project plans to use non-biogenic process CO₂ and is therefore excluded from Figure 4.17 above.

According to announced expansions to 2030, the geographic diversity of low-emission synthetic hydrocarbon fuel production is expected to increase between 2021 and 2030, with around 40% of the planned operating capacity to be based in North America, the vast majority in the United States (HIF Global, 2022) and less than 5% of global capacity in Canada (Carbon Engineering, 2021b).

Regional policy and market developments

The International Civil Aviation Organisation (ICAO) is set to approve a 2050 net zero goal for the aviation sector (ICAO, 2022). While the ICAO's updated emissions reduction goal still relies strongly on out-of-sector offsets, it also envisages achieving emissions reductions through sustainable aviation fuels (SAFs) and low-carbon aviation fuels. If the ICAO focus continues to shift to in-sector emission reduction opportunities, it could substantially increase demand for synthetic hydrocarbon fuels from low-emission hydrogen and non-fossil CO₂ sources.

In the **United States**, the IRA introduced fuel production subsidies for sustainable aviation fuels that meet certain GHG reduction thresholds or CO₂ emissions factors, depending on the subsidy. This could provide financial support for synthetic kerosene projects utilising biogenic and atmospheric CO₂. In California,

the Low Carbon Fuel Standard provides credits for fuels with a lower carbon intensity than the transportation fuel baseline, with credits trading at around USD 80/tonne of CO₂ avoided in December 2022, and as high as USD 200/tonne of CO₂ avoided during 2019-2021. This measure can be combined with the US 45Q tax credit (which has recently been increased under the IRA to USD 60/tonne of CO₂ used, provided emissions reductions are verified) (United States, Congress, 2022).

Around 30% of planned capacity for synfuel production in 2030 is in **Europe**, where new plants will be located in Norway (Norsk e-fuel, 2022), the United Kingdom (Carbon Engineering, 2021c) and Sweden (Liquid Wind, 2022) as well as a few other countries. In the European Union, the Renewable Energy Directive promotes the use of “recycled carbon fuels” as long as they generate emissions savings of at least 70% relative to their fossil counterparts. The REFuelEU aviation policy proposal that is currently under consideration in Europe includes a provision to mandate 0.7% synthetic aviation fuel in the total aviation fuel mix by 2030, increasing to 28% by 2050. If this policy proposal becomes law, regional demand for synthetic hydrocarbon fuels would rise. Government mandates already require low-carbon aviation fuel blends of 0.5% in Norway, 1% in Sweden and 1% in France; the United Kingdom is currently consulting on a similar mandate. In 2021, the UK government announced a GBP 180-million funding package to support the design and construction of sustainable aviation fuel plants in the country. In the Netherlands, the sustainable energy transition subsidy scheme SDE++ is being used to finance an advanced methanol plant at Amsterdam.

Box 4.4 Strategies to decarbonise road transport: Potential role for low-emission synthetic hydrocarbon fuels

Improving the efficiency of internal combustion engine (ICE) vehicles has been a powerful means to moderate growth in oil use and CO₂ emissions in passenger transport. Following the first oil shock, stringent fuel economy standards in the United States drove rapid improvements in vehicle efficiency, which increased from roughly 18 litres per 100 km (l/100 km) in 1975 to 11 l/100km in 1985. Fuel economy standards are now commonplace in most advanced economies, and also in many emerging ones. We estimate that the specific fuel consumption of the global light-duty vehicle fleet has decreased roughly 25% since 2000 and has yielded over 6.5 Gt of CO₂ emissions savings, despite diminishing returns in recent years.

Hybrid powertrains additionally helped cut oil use and CO₂ emissions. This technology, pioneered by Japanese original equipment manufacturers (OEMs), allows a 35% reduction in fuel consumption on average compared with an equivalent

ICE vehicle. Sales of hybrid vehicles began to rise in 2000; they now account for just under 5% of new car sales globally, even though the market share is higher in countries such as Japan (>30%). Hybrids have proven effective to reduce emissions from cars, delivering total savings of around 250 Mt CO₂ since 2000.

Zero-emission vehicles (ZEVs), including battery, plug-in, and fuel cell electric vehicles, are the next technology frontier in passenger cars. They are expected to account for roughly 13% of all new light-duty vehicle sales in 2022, particularly thanks to rapid market adoption of electric cars in China and Europe. Given that their fuels can be produced without emissions or the use of oil, ZEVs can effectively help mitigate climate change and reduce oil use at the same time. As countries transition to renewables and other low-emission electricity generation technologies, the greenhouse gas emissions reduction potential of ZEVs will continue to grow. However, as cars can have a useful lifetime of more than 20 years, it is crucial to scale up ZEV deployment quickly. In the NZE Scenario, no new ICE cars are sold as of 2035 and ZEVs, predominantly electric cars, account for 100% of new cars sales globally.

The rapid scaleup of EV sales in the NZE Scenario does, however, put pressure on supply chains for batteries and the metals required to produce them, with lithium supplies through 2030 being particularly tight (see Chapter 3). Battery innovation is one way to overcome such bottlenecks. Another option is to use advanced biofuels in ICE vehicles or hybrids, but limitations on the availability of sustainable bioenergy is a key bottleneck. A third option under public discussion in some countries is synthetic hydrocarbon (HC) fuels, which are predominantly used in aviation in the NZE Scenario but could, in principle, also be used in other modes of transport.

An advantage of synthetic HC fuels is that their production generally relies on the Fischer-Tropsch (FT) process, which can be optimised to produce synthetic kerosene but currently does not allow for perfect selectivity – that is, not all inputs can be turned into the exact chemical composition required for aviation fuel. Research is currently under way on the use of different catalysts and refinery designs, through which the output slate could vary from roughly equal parts of gasoline, diesel and jet kerosene to mostly jet kerosene and a small share of by-product naphtha.

In one relatively technologically mature option, roughly one-quarter of the output of a jet kerosene-maximised FT process could be standard motor gasoline. This offers the potential to produce low-emission gasoline as a by-product of low-emission kerosene, for use in ICE, hybrid or plug-in hybrid vehicles.

In the NZE Scenario, projected volumes of synthetic HC fuel for aviation imply the possibility to produce over 450 million litres of synthetic gasoline by 2030, and more than 35 billion litres by 2050 when assuming a 1-to-3 ratio in production. This would be sufficient to fuel around 650 000 cars by 2030, and 130 million by 2050. In other

words, in 2050 in the NZE, all ICE and hybrid cars remaining after the phaseout of their sales in 2035 could be fuelled by carbon-neutral gasoline.

Of course, further upscaling of production is possible, and an important upside is that existing refuelling infrastructure could continue to be used and the derived fuel could be traded globally, much like oil products today. Carbon-neutral gasoline is, however, an expensive fuel, even in the long run; IEA analysis using favourable cost expectations for low-emission hydrogen production and for capturing biogenic or atmospheric carbon suggests an oil-equivalent price of between USD 115 and 170 per barrel by 2050. The relative efficiency of the two options also bears consideration: powering a mid-size car for one year with synthetic HC fuels requires over six times more low-emission electricity than if the same car were electric – in other words, fuelling the 400 million ICE and hybrid cars projected to be on the road in advanced economies in the NZE Scenario by 2030 would require at least an additional 5 700 TWh (a 20% increase) of low-emission electricity, more than all the electricity generated by North America today.

Another important consideration is aviation sector low-emission fuel demand, which is likely to outstrip supply for a long time. If jet kerosene could command a sufficiently high price, it might become more profitable for fuel producers to “force” a higher selectivity of the FT process to produce more jet kerosene at the expense of energy efficiency and gasoline production. Even if the costs of forcing higher selectivity remain high, the opportunity to produce a mix of automotive-grade gasoline and distillates (including diesel and fuel oil) points to advantages beyond cars, namely in the heavy-duty road, rail and shipping subsectors.

References

- ACC (2022), Our gigafactories will be producing 40 GWh each by 2030, <https://www.acc-emotion.com/stories/our-gigafactories-will-be-producing-40-gwh-each-2030-how-much-power-does-represent>
- ADM (2020), Carbon Reduction Feasibility Study, <https://assets.adm.com/Sustainability/2019-Reports/ADM-WSP-Feasibility-Study-and-Goal-Document.pdf>
- ADNOC (2021), ADNOC to Build World-Scale Blue Ammonia Project, <https://www.adnoc.ae/news-and-media/press-releases/2021/adnoc-to-build-world-scale-blue-ammonia-project>
- AGORA Energiewende (April 2021), Klimaneutrales Deutschland 2045, Wie Deutschland seine Klimaziele schon vor 2050 erreichen kann, <https://www.agora-energiewende.de/veroeffentlichungen/klimaneutrales-deutschland-2045/>
- Alberta, Department of Energy (2020), Quest Carbon Capture and Storage project: Annual report, 2020, <https://open.alberta.ca/publications/quest-carbon-capture-and-storage-project-annual-report-2020>
- Alberta, Department of Energy (2019), Alberta Carbon Trunk Line project: Knowledge sharing report, 2019, <https://open.alberta.ca/publications/alberta-carbon-trunk-line-project-knowledge-sharing-report-2019>
- Alberta, Government of Alberta (2021), Hydrogen Roadmap, <https://www.alberta.ca/hydrogen-roadmap.aspx>
- Arab News (2021), Al-Yamamah's new factory will meet 40 percent of Kingdom's wind tower demands, CEO says, <https://www.arabnews.com/node/1807696/business-economy>
- Argus (2021), China's Inner Mongolia targets green hydrogen expansion, <https://www.argusmedia.com/en/news/2246287-chinas-inner-mongolia-targets-green-hydrogen-expansion>
- AskCI (2022), Analysis of the upper, middle and lower reaches of China's heat pump industry chain in 2022 (with a panoramic view of the industry chain), https://www.askci.com/news/chanye/20220823/1644171966298_6.shtml
- Benchmark Mineral Intelligence (2022), Lithium Ion Battery Gigafactories Assessment, <https://www.benchmarkminerals.com/gigafactories/> (accessed November 2022).
- Bloom Energy (2021), Bloom Energy Unveils Electrolyzer to Supercharge the Path to Low-Cost, Net-Zero Hydrogen, <https://investor.bloomenergy.com/press-releases/press-release-details/2021/Bloom-Energy-Unveils-Electrolyzer-to-Supercharge-the-Path-to-Low-Cost-Net-Zero-Hydrogen/default.aspx>
- Bloomberg (2022), Tesla's Chinese Battery Maker Is Scoping Out Factory Sites in Mexico, Bloomberg (2021), China's Solar Giants Make a Bid to Dominate Hydrogen Power, 12 December, <https://www.bloomberg.com/news/articles/2021-12-12/china-s-solar-giants-make-a-bid-to-dominate-hydrogen-power#xj4y7vzkg>
- Bloomberg (2022), Tesla's Chinese Battery Maker Is Scoping Out Factory Sites in Mexico, <https://www.bloomberg.com/news/articles/2022-07-18/electric-battery-news-catl-seeks-mexico-site-for-tesla-ford#xj4y7vzkg>
- BloombergNEF (2021), Global Wind Turbine Market Shares 2014-20, BNEF.

- Buljan, A. (2021), GE Expanding Factory in France to House Haliade-X Nacelle Assembly, Offshore Wind, 2 February, <https://www.offshorewind.biz/2021/02/02/ge-expanding-factory-in-france-to-house-haliade-x-nacelle-assembly/>
- Carbon Engineering (2021a), New partnership to deploy large-scale Direct Air Capture in Norway, <https://carbonengineering.com/news-updates/partnership-dac-norway/>
- Carbon Engineering (2021b), Engineering begins on large-scale commercial facility in Canada to produce fuel from air, <https://carbonengineering.com/news-updates/large-scale-commercial-facility-fuel-from-air/>
- Carbon Engineering (2021c), Engineering begins on UK's first large-scale facility that captures carbon dioxide out of the atmosphere, <https://carbonengineering.com/news-updates/uks-first-large-scale-dac-facility/>
- Carbon Engineering (2021d), Carbon Engineering and LanzaTech partner to advance jet fuel made from air, <https://carbonengineering.com/news-updates/ce-lanzatech-jet-fuel/>
- Carbon Capture (2022), Project Bison, <https://www.carboncapture.com/project-bison>
- China, NDRC (National Development and Reform Commission) (2022), Notice on Issuing the "Advanced Level of Energy Efficiency, Energy Conservation Level and Access Level of Key Energy-Using Products and Equipment (2022 Edition)", https://www.ndrc.gov.cn/xwdt/tzgg/202211/t20221117_1341457.html?code=&state=123
- Climeworks (2022), Climeworks takes another major step on its road to building gigaton DAC capacity, <https://climeworks.com/news/climeworks-announces-groundbreaking-on-mammoth>
- Climeworks (2021), Climeworks and 44.01 to unlock the storage potential for air-captured CO₂, <https://climeworks.com/news/climeworks-and-44.01-exploring-new-storage-locations>
- CSIRO (2022), Australian Clean Hydrogen Industrial Hubs Program, <https://research.csiro.au/hyresource/australian-clean-hydrogen-industrial-hubs-program/>
- Cummins (2022), Cummins drives domestic green hydrogen economy forward with first U.S. electrolyzer manufacturing facility, <https://www.cummins.com/news/releases/2022/10/10/cummins-drives-domestic-green-hydrogen-economy-forward-first-us>
- Cummins (2021), Cummins and Sinopec officially launch joint venture to produce green hydrogen technologies in China, <https://www.cummins.com/news/releases/2021/12/21/cummins-and-sinopec-officially-launch-joint-venture-produce-green-hydrogen>
- Drax (2021a), Capturing Carbon at Drax: Delivering Jobs, Clean growth and Levelling up the Humber (report by vivid economics), https://www.drax.com/wp-content/uploads/2021/04/download.aspx_.pdf
- Drax (2021b), Drax and Mitsubishi Heavy Industries sign pioneering deal to deliver the world's largest carbon capture power project, https://www.drax.com/press_release/drax-and-mitsubishi-heavy-industries-sign-pioneering-deal-to-deliver-the-worlds-largest-carbon-capture-power-project/
- E4tech (2022), Database, <https://www.e4tech.com/>

- Electrive (2022), SAIC subsidiary to build fuel cell truck plant in China, <https://www.electrive.com/2022/01/19/saic-subsidiary-to-build-fuel-cell-truck-plant-in-china/>
- Enel (2022), Enel Green Power signs grant agreement with the EU for solar panel gigafactory in Italy, <https://www.enel.com/media/explore/search-press-releases/press/2022/04/enel-green-power-signs-grant-agreement-with-the-eu-for-solar-panel-gigafactory-in-italy>
- Energy Iceberg (2022), China's National Hydrogen Development Plan, <https://energyiceberg.com/national-hydrogen-development-plan/>
- European Commission (2022a), Communication from the Commission to the European Parliament, the European Council, the Council, the European Economic and Social Committee and the Committee of the Regions REPowerEU Plan, <https://eur-lex.europa.eu/legal-content/EN/TXT/?uri=COM%3A2022%3A230%3AFIN>
- European Commission (2022b), REPowerEU: Affordable, secure and sustainable energy for Europe, https://ec.europa.eu/info/strategy/priorities-2019-2024/european-green-deal/repowereu-affordable-secure-and-sustainable-energy-europe_en
- European Commission (2022c), REPowerEU: New industrial Alliance to boost the EU's solar power and energy security, https://energy.ec.europa.eu/system/files/2022-05/COM_2022_221_2_EN_ACT_part1_v7.pdf
- European Commission (2022d), Hydrogen: Commission supports industry commitment to boost by tenfold electrolyser manufacturing capacities in the EU, https://ec.europa.eu/commission/presscorner/detail/e%20n/ip_22_2829
- European Commission (2022e), State Aid: Commission approves up to €5.4 billion of public support by fifteen Member States for an Important Project of Common European Interest in the hydrogen technology value chain, https://ec.europa.eu/commission/presscorner/detail/en/IP_22_4544
- European Commission (2021a), Commission imposes anti-dumping duties on imports of steel wind towers from China, https://policy.trade.ec.europa.eu/news/commission-imposes-anti-dumping-duties-imports-steel-wind-towers-china-2021-12-16_en
- European Commission (2021b), European Green Deal: Commission proposes transformation of EU economy and society to meet climate ambitions, https://ec.europa.eu/commission/presscorner/detail/en/ip_21_354
- European Commission (2021c), Sustainable Carbon Cycles, EC, Brussels.
- Everett, B. and Levine, M. (2022), Manchin's latest shocker: A \$700B deal, Politico, 27 July, <https://www.politico.com/news/2022/07/27/manchin-schumer-senate-deal-energy-taxes-00048325>
- Flender (2021), Flender expands its footprint in Tianjin, China, <https://www.flender.com/medias/Press-Release-Flender-Expansion-of-footprint-in-Tianjin.pdf?context=bWFzdGVyfGRvY3VtZW50c3wxMDAwMTUzfGFwcGxpY2F0aW9uL3BkZnxkb2N1bWVudHMvaDQ2L2gxYy85NTQ5ODUzNzg2MTQyLnBkZnxiZDIkMzljOGE2MDY3M2QxMWNjNTQ3MjE2OTRkYTk5Y2NhNTljMThlZDdmM2Y5NWE0ZDY0NDQ4YjJjZTAyZDYy>.

- France, Ministère de la Transition énergétique (2020), Stratégie nationale pour le développement de l'hydrogène décarboné en France [National strategy for the development of carbon-free hydrogen in France], <https://www.ecologie.gouv.fr/sites/default/files/DP%20-%20Strat%C3%A9gie%20nationale%20pour%20le%20d%C3%A9veloppement%20de%20l%27hydrog%C3%A8ne%20d%C3%A9carbon%C3%A9%20en%20France.pdf>
- Fuel Cells and Hydrogen Joint Undertaking & Hydrogen Europe (2020), Coalition Statement on the deployment of fuel cell and hydrogen heavy-duty trucks in Europe, https://opwegmetwaterstof.nl/wp-content/uploads/2020/11/201123_Coalition-Statement-on-deployment-of-FCH-trucks-in-Europe-1.pdf
- Germany, BMBF (Federal Ministry of Education and Research) (2021), How the H2Giga flagship project aims to mass produce electrolyzers for the production and scale-up of hydrogen, <https://www.wasserstoff-leitprojekte.de/projects/h2giga>
- Germany, BMWK (Federal Ministry for Economic Affairs and Climate Action) (2021), Overview of the core elements of the funding guideline to support the international establishment of generating installations for green hydrogen, <https://www.bmwk.de/Redaktion/EN/Pressemitteilungen/2021/10/20211004-overview-of-the-core-elements-of-the-funding-guideline-to-support-the-international-establishment-of-generating-installations-for-green-hydrogen.html>
- Haru Oni (2022), Tomorrow's fuel, <https://www.haruoni.com/#/en>
- HIF Global (2022), HIF Global Selects Matagorda County, Texas for eFuels Facility, https://www.hifglobal.com/docs/default-source/default-document-library/hif-global-selects-matagorda-county-for-efuels-facility.pdf?sfvrsn=6c09dfb1_3
- Hyzon (2021), Hyzon Motors to Build United States' Largest Fuel Cell Material Production Facility, <https://www.hyzonmotors.com/in-the-news/largest-fuel-cme-production-facility>
- ICAO (International Civil Aviation Organization) (2022), Draft Text for the Report on Agenda Item 17, https://www.icao.int/Meetings/a41/Documents/WP/wp_602_en.pdf?utm_source=Climate+Extra&utm_campaign=5cabbf6b8f-EMAIL_CAMPAIGN_2021_10_18_09_22_COPY_01&utm_medium=email&utm_term=0_126c4c3fe3-5cabbf6b8f-408123614
- IEA (International Energy Agency) (2022a), World Energy Employment Report, <https://www.iea.org/reports/world-energy-employment>
- IEA (2022b), Special Report on Solar PV Global Supply Chains, <https://www.iea.org/reports/solar-pv-global-supply-chains>
- IEA (2022c), Heat Pumps, <https://www.iea.org/reports/heat-pumps>
- IEA (2022d), The Future of Heat Pumps, <https://www.iea.org/reports/the-future-of-heat-pumps>
- IEA (2022e), Global Hydrogen Review 2022, <https://www.iea.org/reports/global-hydrogen-review-2022>
- IEA (2022f), Direct Air Capture 2022, <https://www.iea.org/reports/direct-air-capture-2022>
- IEA (2022g), Investment tax credit for carbon capture, utilisation and storage (CCUS), <https://www.iea.org/policies/13346-investment-tax-credit-for-carbon-capture-utilisation-and-storage-ccus>
- IEA (2021), An Energy Sector Roadmap to Carbon Neutrality in China, <https://www.iea.org/reports/an-energy-sector-roadmap-to-carbon-neutrality-in-china>

- IEA (2020), Is cooling the future of heating?, <https://www.iea.org/commentaries/is-cooling-the-future-of-heating>
- IEA (2015), Storing CO₂ through Enhanced Oil Recovery, <https://www.iea.org/reports/storing-co2-through-enhanced-oil-recovery>
- India, PM India (Prime Minister's Office) (2022), Cabinet approves Production Linked Incentive Scheme on "National programme on High Efficiency Solar PV Modules" for achieving manufacturing capacity of Giga Watt (GW) scale in High Efficiency Solar PV Modules, https://www.pmindia.gov.in/en/news_updates/cabinet-approves-production-linked-incentive-scheme-on-national-programme-on-high-efficiency-solar-pv-modules-for-achieving-manufacturing-capacity-of-giga-watt-gw-scale-in-high-eff/
- Innovationsregion Ulm (2022), Dana Neu-Ulm invests high double-digit million amount in bipolar plate production, <https://innovationsregion-ulm.de/2022/05/27/dana-neu-ulm-invests-high-double-digit-million-amount-in-bipolar-plate-production/?lang=en>
- IPCC (Intergovernmental Panel on Climate Change) (2022), Climate Change 2022: Mitigation of Climate Change, <https://www.ipcc.ch/report/sixth-assessment-report-working-group-3/>
- ITM Power (2021), Manufacturing Commences at the ITM Power Gigafactory, <https://itm-power.com/news/manufacturing-commences-at-the-itm-power-gigafactory>
- Japan, METI (Ministry of Economy, Trade and Industry) (2022), Memorandum of cooperation between the Ministry of economy, trade and industry of Japan, and the ministry of Energy and mineral resources of the Republic of Indonesia on the realization of energy transitions, <https://www.meti.go.jp/press/2021/01/20220113003/20220113003-1.pdf>
- John Cockerill (2022), Greenko and John Cockerill partner in hydrogen to contribute to Indian economy's decarbonisation, https://johncockerill.com/wp-content/uploads/2022/04/20220405_joint-press-release-signature-agreement-jc-greenko_final-2.pdf
- John Cockerill. (2019), Cockerill Jingli Hydrogen, world leader in hydrogen, inaugurates its new production center at Suzhou, <https://johncockerill.com/en/press-and-news/news/cockerill-jingli-hydrogen-world-leader-in-hydrogen-inaugurates-its-new-production-center-at-suzhou-china/>
- Lee, A. (2022), China's Envision unveils big India factory plans after multi-gigawatt turbine deal, Recharge, 27 April, <https://www.rechargenews.com/wind/chinas-envision-unveils-big-india-factory-plans-after-multi-gigawatt-turbine-deal/2-1-1207961>
- Liquid Wind (2022), Flagships, <https://www.liquidwind.se/flagships>
- Marubeni (2022), Memorandum of Understanding has been signed with PT Pertamina (Persero) for Development of Decarbonization Projects in Indonesia, <https://www.marubeni.com/en/news/2022/release/00016.html>
- Maryland Clean Energy Center (2022), Inflation Reduction Act Sets Stage for Massive Investment in Clean Energy, <https://www.mdcleanenergy.org/inflation-reduction-act-sets-stage-for-massive-investment-in-clean-energy/>
- Mitsui (2022), Joint Study Agreement formed to evaluate development of clean hydrogen supply chain between UAE and Japan, https://www.mitsui.com/jp/en/topics/2022/1243577_13410.html
- Norsk e-fuel (2022), About us, <https://www.norsk-e-fuel.com/about-us>

- NREL (National Renewable Energy Laboratory) (2022), Supply Chain Road Map for Offshore Wind Energy, <https://www.nrel.gov/wind/offshore-supply-chain-road-map.html>
- Nutrien (2020), AEA Conference 2020 – Low Carbon Ammonia Certification, <https://www.ammoniaenergy.org/wp-content/uploads/2020/12/Blake-Adair.pdf>
- Orsted (2022), Partnership behind “Green Fuels for Denmark” accelerates project and investigates production of green jet fuel by 2025, <https://orsted.com/en/media/newsroom/news/2022/02/20220204476711>
- Oxy (2022a), Third Quarter Earnings Conference Call, <https://www.oxy.com/globalassets/documents/investors/quarterly-earnings/oxy3q22conferencecallsides.pdf>
- Oxy (2022b), LCV Investor Update, <https://www.oxy.com/investors/stockholder-resources/lcv-investor-update>
- Passive House Institute (2022), Passive House Institute, <https://passivehouse.com/>
- Plug Power (2021a), Plug Power hosts grand opening of hydrogen and fuel cell innovation center gigafactory in Monroe County, <https://www.ir.plugpower.com/press-releases/news-details/2021/Plug-Power-Hosts-Grand-Opening-of-Hydrogen-and-Fuel-Cell-Innovation-Center-Gigafactory-in-Monroe-County-2021-11-12/default.aspx>
- Plug Power (2021b), Plug Power to Partner with Fortescue Future Industries to Manufacture Electrolyzer Technology in Australia, <https://www.ir.plugpower.com/press-releases/news-details/2021/Plug-Power-to-Partner-with-Fortescue-Future-Industries-to-Manufacture-Electrolyzer-Technology-in-Australia-2021-10-14/default.aspx>
- PVTIME (2022), 14.55 Billion Yuan! LONGi Adds Production Capacity of Silicon Material to 46GW in Inner Mongolia Base, <https://www.pvtime.org/14-55-billion-yuan-longi-adds-production-capacity-of-silicon-material-to-46gw-in-inner-mongolia-base/>
- Shepardson, D. (2022), GM, LG Energy joint venture Ohio battery plant begins production, Reuters, 1 September, <https://www.reuters.com/business/autos-transportation/gm-lg-energy-joint-venture-ohio-battery-plant-begins-production-2022-08-31/>
- Rewiring America (2022), Electrify for Peace Policy Plan, <https://www.rewiringamerica.org/policy/electrify-for-peace-policy-plan>
- Richard, C. (2021), Chinese OEM MingYang “plans wind turbine plant” in southern Germany, Wind Power Monthly, 24 September, <https://www.windpowermonthly.com/article/1728531/chinese-oem-mingyang-plans-wind-turbine-plant-southern-germany>
- Rystad Energy (2022), Inflation Reduction Act will attract an extra \$270 billion in US wind and solar investments by 2030, <https://www.rystadenergy.com/news/inflation-reduction-act-will-attract-an-extra-270-billion-in-us-wind-and-solar-in>
- Samsun, R.C. et al. (2022), Deployment of Fuel Cell Vehicles and Hydrogen Refueling Station Infrastructure: A Global Overview and Perspectives, Energies, Vol. 15(14), pp. 4975, <https://www.mdpi.com/1996-1073/15/14/4975/htm>
- Shaw, V. (2022), Chinese PV Industry Brief: Canadian Solar to build new Qinghai production base, PV Magazine, 9 August, <https://www.pv-magazine.com/2022/08/09/chinese-pv-industry-brief-canadian-solar-to-build-new-qinghai-production-base/>

- Siemens Gamesa (2022), Tripling in Taiwan: Siemens Gamesa to massively expand offshore nacelle manufacturing activities, <https://www.siemensgamesa.com/newsroom/2022/09/092122-siemens-gamesa-press-release-taiwan-offshore-nacelle-manufacture>
- Sino German Cooperation on Climate Change (2022), China released its 14th five-year plan for renewable energy with quantitative targets for 2025, <https://climatecooperation.cn/climate/china-released-its-14th-five-year-plan-for-renewable-energy-with-quantitative-targets-for-2025/>
- Stellantis (2022), Stellantis and LG Energy Solution to Invest Over \$5 Billion CAD in Joint Venture for First Large Scale Lithium-Ion Battery Production Plant in Canada, https://www.stellantis.com/en/news/press-releases/2022/march/stellantis-and-lg-energy-solution-to-invest-over-5-billion-cad-in-joint-venture-for-first-large-scale-lithium-ion-battery-production-plant-in-canada?adobe_mc_ref=
- Storegga (2021), Engineering begins on UK's first large-scale facility that captures carbon dioxide out of the atmosphere, <https://www.storegga.earth/news/2021/news/engineering-begins-on-uk-s-first-large-scale-facility-that-captures-carbon-dioxide-out-of-the-atmosphere/>
- Summit Carbon Solutions (2021), Summit Agricultural Group Announces Creation of Summit Carbon Solutions, <https://summitcarbonsolutions.com/summit-agricultural-group-announces-creation-of-summit-carbon-solutions-and-worlds-largest-carbon-capture-and-storage-project/>
- Surfeo (2022), Faurecia's strategy to conquer Asia and Europe, <https://surfeo.eu/hydrogen-automotive-industry-faurecias-strategy-to-conquer-asia-and-europe/>
- Sweden, Swedish Energy Agency (2022), National Centre for CCS, <http://www.energimyndigheten.se/en/sustainability/carbon-capture-and-storage/state-aid-for-beccs/>
- Tesla (2011), Panasonic Enters into Supply Agreement with Tesla Motors to Supply Automotive-Grade Battery Cells, <https://www.tesla.com/blog/panasonic-enters-supply-agreement-tesla-motors-supply-automotivegrade-battery-c>
- The White House (2022), Fact Sheet: Biden-Harris Administration Advances Cleaner Industrial Sector to Reduce Emissions and Reinvigorate American Manufacturing, <https://www.whitehouse.gov/briefing-room/statements-releases/2022/02/15/fact-sheet-biden-harris-administration-advances-cleaner-industrial-sector-to-reduce-emissions-and-reinvigorate-american-manufacturing/>
- Topsoe (2022), Topsoe Confirms Final Investment Decision For Construction of World's Largest SOEC Electrolyzer Plant, <https://blog.topsoe.com/topsoe-confirms-final-investment-decision-for-construction-of-worlds-largest-electrolyzer-plant>
- Toshiba (2020), Toshiba Starts Operation of Large-Scale Carbon Capture Facility, <https://www.global.toshiba/ww/news/energy/2020/10/news-20201031-01.html>
- United Kingdom, BEIS (Department for Business, Energy & Industrial Strategy) (2022), Business model for power bioenergy with carbon capture and storage (Power BECCS), <https://www.gov.uk/government/consultations/business-model-for-power-bioenergy-with-carbon-capture-and-storage-power-beccs>
- United Kingdom, BEIS (2021), Net Zero Strategy: Build Back Greener, <https://www.gov.uk/government/publications/net-zero-strategy>

- United Kingdom, BEIS (2020), Heat Pump Manufacturing Supply Chain Research Project, https://assets.publishing.service.gov.uk/government/uploads/system/uploads/attachment_data/file/943712/heat-pump-manufacturing-supply-chain-research-project-report.pdf
- United Kingdom, HM Government (2022), British Energy Security Strategy, Policy paper, <https://www.gov.uk/government/publications/british-energy-security-strategy/british-energy-security-strategy>
- United Kingdom, HM Government (2020), The Ten Point Plan for a Green Industrial Revolution, https://assets.publishing.service.gov.uk/government/uploads/system/uploads/attachment_data/file/936567/10_POINT_PLAN_BOOKLET.pdf
- United Kingdom, UK Government (2021), Wind of change for the Humber region, <https://www.gov.uk/government/news/wind-of-change-for-the-humber-region>
- United States, Congress (2022), H.R.5376 – Inflation Reduction Act of 2022, <https://www.congress.gov/bill/117th-congress/house-bill/5376>
- United States, Congress (2020), H.R.7516 - Clean Energy Innovation and Deployment Act of 2020, <https://www.congress.gov/bill/116th-congress/house-bill/7516/text>
- United States, Congress (2018), H.R.2 - Agriculture Improvement Act of 2018, <https://www.congress.gov/bill/115th-congress/house-bill/2>
- United States, DOE (Department of Energy) (2022a), Residential Cold Climate Heat Pump Challenge, <https://www.energy.gov/eere/buildings/residential-cold-climate-heat-pump-challenge>
- United States, DOE (2022b), Biden-Harris Administration Announces \$250 Million Investment From Inflation Reduction Act For Domestic Heat Pump Manufacturing, <https://www.energy.gov/articles/biden-harris-administration-announces-250-million-investment-inflation-reduction-act>
- United States, DOE (2022c), Biden-Harris Administration Announces Historic \$7 Billion Funding Opportunity to Jump-Start America's Clean Hydrogen Economy, <https://www.energy.gov/articles/biden-harris-administration-announces-historic-7-billion-funding-opportunity-jump-start>
- United States, DOE (2022d), President Biden Invokes Defense Production Act to Accelerate Domestic Manufacturing of Clean Energy, <https://www.energy.gov/articles/president-biden-invokes-defense-production-act-accelerate-domestic-manufacturing-clean>
- United States, DOE (2022e), United States Energy & Employment Report 2022,
- United States, DOE (2018), Demonstration of Carbon Capture and Sequestration of Steam Methane Reforming Process Gas Used for Large-Scale Hydrogen Production, <https://www.osti.gov/biblio/1437618>
- Upstream (2021), North Dakota approves landmark CCS project, <https://www.upstreamonline.com/energy-transition/north-dakota-approves-landmark-ccs-project/2-1-1085735>
- Veolia (2022), Cutting-edge Power-to-Liquid project transforms municipal waste-derived CO₂ into sustainable aviation fuels (SAF) in Portugal, <https://www.veolia.com/en/our-media/newsroom/press-releases/power-liquid-project-transforms-municipal-waste-waste-derived-CO2-portugal>

- Vestforbrænding (2019), Vestforbrænding will capture CO₂ in the future, <https://www.vestfor.dk/nyheder-og-presse/nyheder/vestforbraending-vil-indfange-co2-i-fremtiden/>
- Volkswagen (2021), Volkswagen Group creates European company for its battery business, <https://www.volkswagenag.com/en/news/2021/12/volkswagen-group-creates-european-company-for-its-battery-busine.html>
- Wind Europe (2022), Offshore wind vessel availability until 2030: Baltic Sea and Polish perspective, Wind Europe.
- Wood Mackenzie (2022), Global Wind Turbine OEMs Market Share Forecasts 2022, Wood Mackenzie.
- Xiaomei, S. (2022), 18.8 billion! Goldwind Deploys Wenzhou Offshore Wind Power Industry Base, Saatao, 14 April, <https://www.seetao.com/details/151202.html>

Chapter 5. Enabling infrastructure

Highlights

- Infrastructure to transport and store electricity, hydrogen and CO₂ is an often-overlooked – but critical – enabler of clean energy transitions. The Net Zero Emissions by 2050 (NZE) Scenario is a useful indicator of the potential needs: in the NZE Scenario, the global length of power transmission lines increases by around 185% and distribution lines by almost 165% over 2021-2050, with 85% of the additions occurring in emerging economies. Trade in low-emission hydrogen, which is almost non-existent today, covers more than 20% of global merchant hydrogen demand by 2030. Annual CO₂ storage injection capacity jumps from around 42 million tonnes (Mt) of CO₂ today to around 1.2 gigatonnes (Gt) by 2030, requiring a huge expansion of CO₂ transport and storage infrastructure.
- Such rapid growth would place considerable demands on supply chains. Annual Metal use for power transmission lines, distribution grids and transformers grows by around 50% in 2022-2030 in the NZE Scenario, compared to today. Copper used for grids and transformers in 2022-2030 corresponds to almost 20% of global copper production in 2030. Manufacturing power transformers requires grain-oriented electrical steel (GOES), with five countries – China, Japan, Korea, Russia and United States – today accounting for almost 85% of global production capacity of 3.8 Mt per year. Demand for GOES alone doubles to 6 Mt per year over 2022-2030 in the NZE Scenario.
- Global annual investments in low-emission hydrogen and hydrogen-derived fuel transport, including in pipelines, storage facilities, terminals and refuelling stations reach more than USD 50 billion over the latter half of this decade in the NZE Scenario – equal to almost 40% of current annual spending on natural gas pipelines and shipping infrastructure. With increasing demand for hydrogen and hydrogen-derived fuels over time, infrastructure investments reach more than USD 80 billion in 2041-2050.
- CO₂ infrastructure deployment also accelerates in the NZE Scenario, but it is constrained by the required lead times for developing CO₂ storage capacity. Unlike for critical minerals, fewer assessments have been done to identify CO₂ storage reserves. Confidence in CO₂ storage availability is necessary to assure investment in capture facilities and transport infrastructure, so resources must be assessed as soon as possible.
- Building energy infrastructure today can take more than a decade. While construction is in most cases a relatively efficient process, taking two to four years, planning and permitting can often cause delays and create bottlenecks, with the process taking two to seven years, depending on the jurisdiction and infrastructure type. Lead times for infrastructure projects are usually much longer than for the facilities that connect to them.

The role of enabling infrastructure

Transportation, transmission, distribution and storage infrastructure is a critical element of the supply chains for low-emission electricity and hydrogen production, and CO₂ management. The uneven geographic distribution of fossil-based and renewable energy resources requires infrastructure to link regions where energy can be produced at lower cost with demand centres, while energy storage is needed to balance fluctuations in production and demand. Similarly, CO₂ needs to be transported from where it is generated to geological storage sites where it can be injected and permanently removed from the atmosphere. Infrastructure that moves or stores energy or CO₂ plays a central role in enabling decarbonisation of the energy system while improving energy security by diversifying supply routes for energy imports and ensuring energy sector resilience to supply disruptions. Long-term planning, taking account of interdependencies among different carriers and sector coupling, is vital to ensure that this enabling infrastructure expands and adapts in a timely manner.

Infrastructure is already an important element of energy supply chains today. The global length of the electricity transmission and distribution grid grew by more than one-quarter over the last decade, reaching roughly 80 million kilometres (km) today (Figure 5.1).

Figure 5.1 Global historic deployment and investments in electricity and natural gas infrastructure

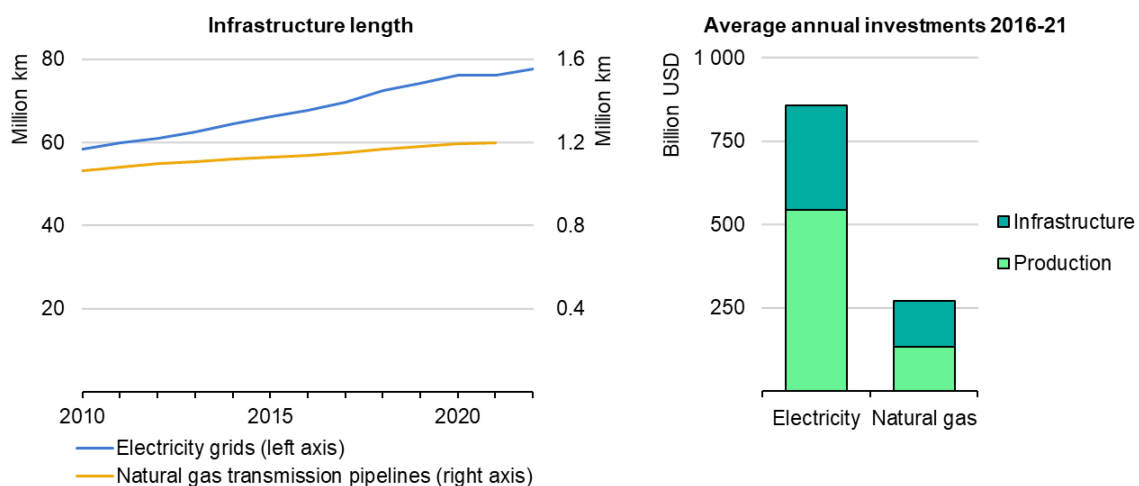

IEA. CC BY 4.0.

Notes: km = kilometre. Electricity grid lengths include transmission and distribution. Investments in electricity infrastructure include transmission and distribution grids as well as stationary storage. Investments in natural gas infrastructure include natural gas pipelines, liquefied natural gas (LNG) terminals and LNG tankers.

Infrastructure is an important element of energy supply chains today, accounting for 36% of investments in the electricity sector and 51% in the natural gas sector.

Annual investments in electricity grids and stationary storage totalled on average USD 313 billion in the period 2016-2021, making up more than one-third of all electricity sector investments. For natural gas production, transport and storage, infrastructure investments accounted for more than 50% of investments in this sector in 2016-2021. Overall, electricity and natural gas infrastructure claimed around 20% of energy sector investments in this period.

The purpose of this chapter is to assess the role of infrastructure in clean energy technology supply chains and identify potential bottlenecks in infrastructure development, focusing on electricity, hydrogen and CCUS – key decarbonisation pillars for which infrastructure is an essential step in the energy supply chain. The requirements and potential barriers to scaling up infrastructure for electricity, hydrogen and CO₂ are very different:

Electricity transmission and distribution networks have existed for more than a century. Increasing electrification of the energy system and boosting electricity generation from variable utility-owned and distributed renewable sources will require major network changes to ensure that supply and demand are always in balance, given that electricity is more difficult and expensive to store than solid, liquid or gaseous fuels. Digitalisation, smart systems and new high-power semiconductor technologies are becoming increasingly important to gain better control over electricity flows and maintain network stability.

Hydrogen infrastructure is at a very nascent stage today, though some regional hydrogen pipeline networks and storage sites already exist in Europe, the United States and the Asia Pacific region. Due to its low volumetric energy density and liquefaction point, as well as its detrimental effect on steel, hydrogen is more difficult and costly to transport and store than natural gas, as it involves more energy intensive compression and liquefaction, or conversion to higher-density carriers.

CO₂ management infrastructure (transport networks and geological storage sites) will need to be developed in parallel with (if not earlier than) CO₂ capture facilities. Confidence in the availability of suitable storage resources that can support sustained CO₂ injection will be vital to the development of capture facilities, as will assurances that pathways exist to transport CO₂ from its point of capture to the point of storage. For this to happen, storage resources around the world will need to be more thoroughly assessed and jurisdictions will have to work together to develop legal and regulatory frameworks that facilitate the transport and geological storage of CO₂.

Progress in deploying infrastructure for clean energy and CO₂ management is currently very uneven. Electricity grids exist in all countries today but are not always adapted to handle increasing variable renewable energy generation or to support demand-side flexibility measures. Infrastructure for hydrogen and CO₂ is

at a very early stage of development. Getting to net zero by mid-century will therefore require a rapid scaleup of energy infrastructure. In some cases, major innovations are needed to reduce costs and improve performance to make infrastructure commercially viable.

Electricity grids

Types of grids and technology components

Electricity grids and networks are already a central part of the global energy system and will become even more important as the clean energy transition advances. There are around 80 million km of power lines in the world. Each grid can be differentiated by voltage level. Low-voltage lines of less than 1 kilovolt (kV) supply electricity to residential and commercial users, while medium-voltage lines (1-35 kV) are used to supply villages and small and medium-sized industrial sites.³⁷ Together, these lines form the distribution network. The distribution networks of cities and large industrial consumers are connected to the high-voltage network, which – together with extra-high voltage (more than 245 kV)³⁸ and ultra-high voltage (more than 800 kV) lines – forms the transmission grid used to transport electricity over longer distances (Figure 5.2).

Most electricity grids today carry alternating current (AC), historically produced by rotating generators in thermal or hydroelectric power plants. Renewable generating technologies such as solar photovoltaic (PV) and wind systems, as well as batteries and fuel cells, are connected to the power grid by power-electronic converters.³⁹ A major advantage of AC over DC for networks is that the voltage can be modified relatively easily using power transformers to up-transform the electricity for transport over long distances to minimise losses and down-transform it for industrial, commercial and residential uses in regional or local distribution grids. Transformers have a wide range of rated power. Distribution transformers have a capacity of 0.15-15 megavolt amperes or MVA (which measures apparent power), depending on the country. In the transmission grid, ratings for small power transformers are up to 50 MVA and for medium ones are up to 100 MVA, while large transformers have higher power ratings.

³⁷ Medium voltage levels according to the International Electrochemical Commission IEC 60038: 1 kV-35 kV; European Norm EN 50160: 1 kV-36 kV; American National Standards Institute ANSI C84.1: 2.4 kV-69 kV.

³⁸ High voltage levels according to the International Electrochemical Commission IEC 60038: above 245 kV; European Norm EN 50160: 36 kV-150 kV; American National Standards Institute ANSI C84.1: above 345 kV.

³⁹ Solar PV systems, batteries and fuel cells generate direct current (DC) that cannot be connected directly to an AC grid, so output must be converted to AC. Wind power systems usually generate AC, but they are also connected to the grid by an inverter with a direct voltage intermediate circuit (AC/DC/AC) to be able to operate the wind turbine irrespective of the grid frequency at the most efficient speed according to wind conditions.

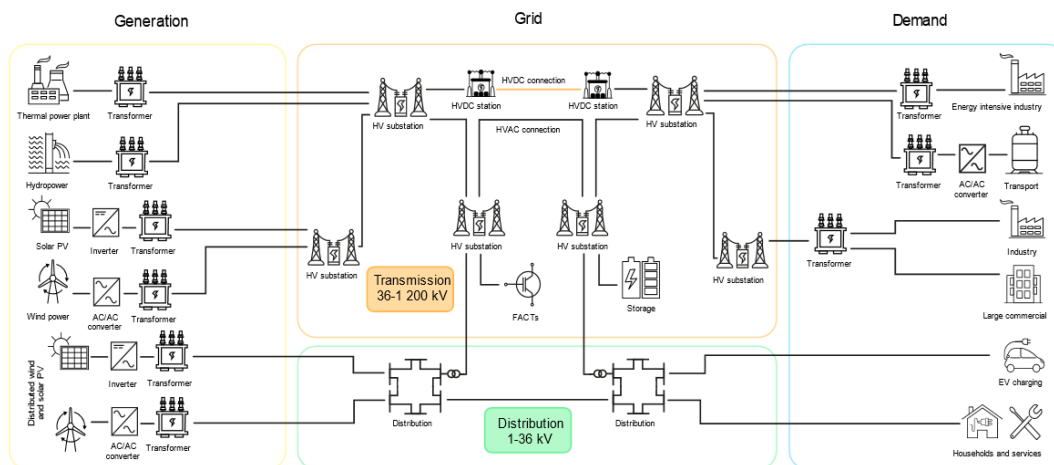
Figure 5.2 Key technology components of electricity grids

IEA. CC BY 4.0.

Note: HVAC = high-voltage alternating current; HVDC = high-voltage direct current.

Power grids comprise transmission and distribution networks, with overhead, underground and subsea AC and DC cables, each with different technology and material needs.

High-voltage direct current (HVDC) point-to-point transmission, which involves fewer power losses, is becoming more common, mainly for long distances but also over medium and short distances. The technology was first used in the 1930s employing mercury-arc valves, but after 1970s the introduction of high-power semiconductors led to the use of thyristors in HVDC converter stations, which makes smaller HVDC systems more economical. The latest generation (insulated-gate bipolar transistors) offers several further benefits, such as independent and flexible control of active and reactive power (which flows back and forth within the system), flexible AC voltage control, and the ability to stabilise the system in the event of network faults and to black-start networks (restore part of a grid without relying on the external transmission network in the event of a total or partial shutdown). Most HVDC links today have voltages of between 300 kV and 800 kV, but there are projects that operate at 1 100 kV, such as one in the People's Republic of China (hereafter, "China"), which has a transmission capacity of up to 12 gigawatt (GW). Besides being an efficient way to transmit power onshore, HVDC systems can also connect offshore wind farms, particularly in remote locations where underwater AC cabling is not economical or technically feasible. Today, HVDC transmission losses over 1 000 km are around 3% compared with more than 7% using AC lines.

The total length of HVDC lines around the world has almost tripled since 2010, reaching more than 100 000 km (with total transmission capacity of more than 350 GW) at the end of 2021, though this still represents just 2% of total transmission length (Figure 5.3). Long-distance overhead lines in China and

Brazil, and underground and submarine cables in Europe make up most of this growth. Almost 50% of all HVDC lines were in China in 2021, while Europe accounted for 10% of global HVDC line length.

Figure 5.3 Global high-voltage direct current (HVDC) transmission lines by country/region and line type

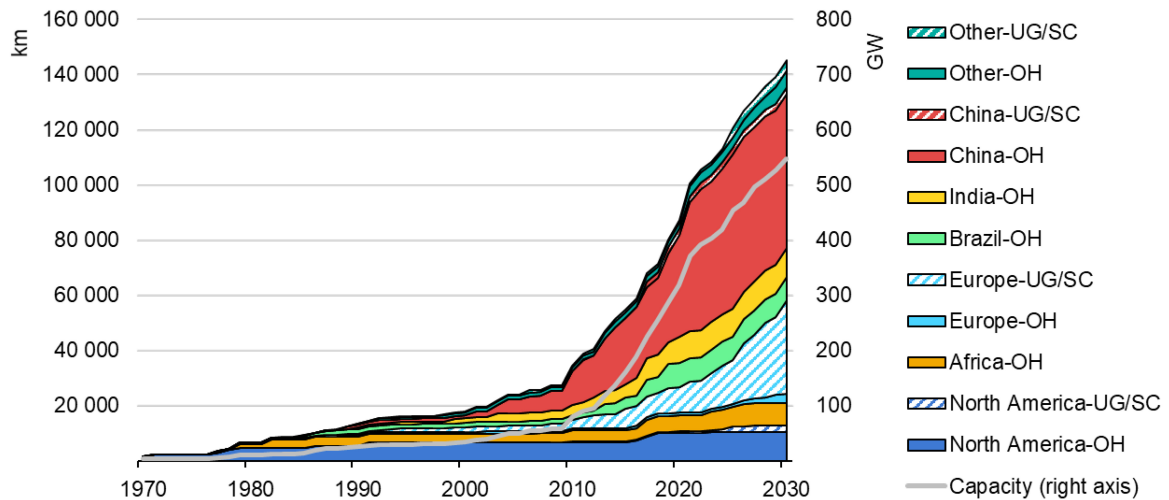

IEA. CC BY 4.0.

Notes: UG = underground cable; SC = subsea cable; OH = overhead transmission line; km = kilometre; GW = gigawatt. Data are for year-end. "Capacity" refers to global HVDC transmission capacity, but excludes the capacity of HVDC back-to-back systems, which are used to link two AC networks. Data for 2023-2030 are based on announced projects.

Sources: IEA research; RTE International (2022).

The global length of HVDC lines has almost tripled since 2010 to today with additions of overhead lines in China, North America and India, and offshore cables in Europe.

Both high-voltage AC (HVAC) and HVDC transmission lines can involve overhead, underground or subsea cables. Overhead lines usually consist of uninsulated wires and are suspended by towers or poles made of steel, aluminium, concrete or reinforced plastics. As the surrounding air provides insulation, overhead power lines are generally the cheapest transmission option. Underground cables consist of conductors encased in insulating material and often a protective jacket. They cost up to five times more than overhead lines, due to higher material needs and construction/installation costs, but they are increasingly being used in advanced economies because they are less visible and vulnerable to extreme weather events.

The way electricity grids are operated is changing with the emergence of new variable sources of generation and types of demand. Most operational decisions today are based on load flow analysis in local monitoring systems, which works well when the power flows from centralised generation capacity to consumers are largely predictable within a local or national system. The increasing integration of energy flows over longer distances and the rise of variable renewable power

generation is reducing the predictability of electricity flows through the system, making it harder to prevent local line overloads. New monitoring and control devices that use digital technologies can provide system information in real time and help deal with these problems. Dynamic line sensors can increase the transmission capacity rating of lines based on environmental and weather conditions,

The deployment of smart meters in the distribution network is an essential step in developing smart grids. Around 1.1 billion smart meters had been installed globally at the end of 2021 – almost 40% of all residential meters. Smart meters can increase service quality and enable the introduction of innovative demand-side response measures by allowing customers to manage their consumption, e.g. based on variable electricity tariffs. Another step is remote control and advanced protection devices capable of managing bidirectional energy flows and identifying grid faults quickly. Other digital solutions include advanced voltage regulation at the distribution-grid level that can increase the hosting capacity of the grid and enable the integration of the increasing number of decentralised sources of renewable electricity. In 2021, digital infrastructure accounted for 19% of global investment in electricity grids, with 75% of it in the distribution grid.

The ability to operate a network covering a large area depends on power electronic technologies such as synchronous condensers, static synchronous compensators and thyristor-controlled series compensation, which are part of the family of flexible AC transmission devices. These devices allow control over power flows, voltage levels and other stability characteristics almost in real time while generating reactive power, which increases power transmission capacity and stabilises the grid. These capabilities become increasingly important as the contribution of solar PV and wind power generation grows, as these inverter-based sources provide limited amounts of inertia (the energy stored in large rotating generators), which is necessary to keep the network stabilised, especially in the event of an unplanned power outage. Historically, inertia has been largely provided by large conventional power plants.

Energy storage is set to be an increasingly important part of electricity grids as renewables-based generation increases. Energy storage systems, such as batteries or pumped-storage hydro plants, can also support the integration of growing shares of variable renewable electricity generation and effectively balance increasing electrified demand on different time scales, from milliseconds to seasons. Battery systems are becoming more common thanks to technological advances and lower costs. Global installed capacity reached 27 GW (108 gigawatt hours [GWh]) at the end of 2021. As batteries are modular and scalable, they can be deployed quickly anywhere to balance variable renewable generation and provide various grid services on a short time scale by responding instantaneously to sudden supply-demand imbalances and by maintaining frequency stability.

Battery systems equipped with virtual synchronous machine control algorithms can deliver an inertial response similar to the mechanical inertia provided by rotating machines.

With over 160 GW of installed capacity worldwide, pumped-storage power plants are the largest source of electricity storage today. Pumped-storage hydro facilities equipped with variable-speed pumps supplied by static frequency converters can regulate their speed and power consumption in pumping mode and increase system flexibility and stability. Pumped-storage hydro reservoirs can store large amounts of energy longer than batteries and can perform a substantial number of charge-discharge cycles over a very long period.

Other storage options include compressed air storage, with three large-scale plants in operation in Germany, the United States and China (Borri et al., 2022). Storing electricity in the form of hydrogen in underground storage sites such as salt caverns and reconvert it back to electricity is another long-term, large-scale storage option (see Bulk Hydrogen Storage below). Gravity storage could be a cost-effective way to compensate for short-term losses of power availability. Other short-term storage options such as high-power capacitors or flywheels could be used to stabilise the grid. Storing electricity in the form of high-temperature heat and converting the heat back into electricity is another storage option under investigation.

Grid expansion in the NZE Scenario

Electricity grids undergo rapid expansion in the Net Zero Emissions by 2050 (NZE) Scenario. By 2030, the global length of transmission lines increases by almost 2.5 million km (compared with 1 million km over 2013-2021), while distribution networks grow by more than 16 million km (12 million km in 2013-2021). Most of the additions occur after 2030, with the global length of transmission lines increasing by more than 9.5 million km (+186%) by 2050, and distribution lines by 115 million km (almost 165%) over 2022-2050. Gross additions are even more impressive, totalling more than 170 million km, as many existing lines will need to be replaced by 2050 (Figure 5.4). Around 80% of global gross grid additions occur in the emerging market and developing economies. In advanced economies, the majority of new lines replace existing ones. HVAC remains the dominant technology for transmission lines in the NZE Scenario.

Figure 5.4 Gross electricity grid additions in advanced and emerging economies in the NZE Scenario

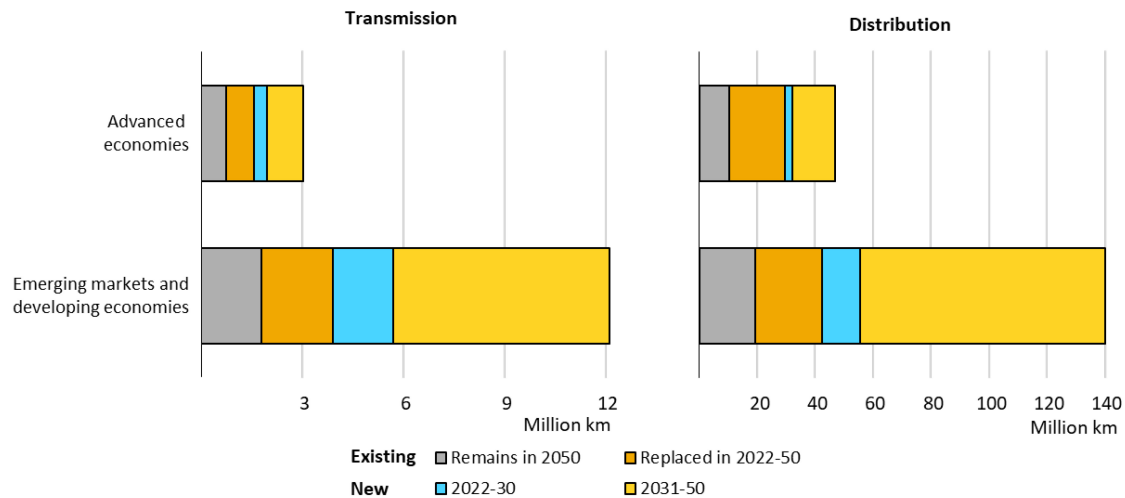

IEA. CC BY 4.0.

Around 80% of global gross grid additions to 2050 are in emerging economies in the NZE Scenario, with the bulk of new lines in advanced economies replacing existing ones.

The rapid growth in electricity use in the NZE Scenario, which jumps by almost 50% between 2021 and 2030, drives up demand for all types of electrical supply equipment. Global transformer additions double from an average of 2.4 GW/year over 2012-2021 to 4.9 GW/year in 2022-2030, with three-quarters occurring in emerging economies (Figure 5.5). Additions fall again after 2040 as demand growth begins to slow. Stationary battery storage also grows rapidly, with capacity rising from 108 GWh today to 3 100 GWh by 2030 mainly owing to the increasing need for system flexibility. Nonetheless, stationary-battery deployment is still dwarfed by that of electric vehicle (EV) batteries, which register global capacity of 5.5 terawatt-hours (TWh) in 2030. By 2050, with higher power system flexibility needs prompting greater deployment of stationary batteries, their capacity rises to 15.5 TWh. Average annual grid investments of USD 520 billion (in real 2021 US dollars) are needed during 2022-2030 in the NZE Scenario – almost twice the USD 308 billion spent in 2021 – and USD 1 034 billion per year is required over 2031-2050. Electricity grids represent 30% of power sector investments by 2030 and 45% by 2050.

Figure 5.5 Average annual transformer and stationary-battery capacity additions in the NZE Scenario

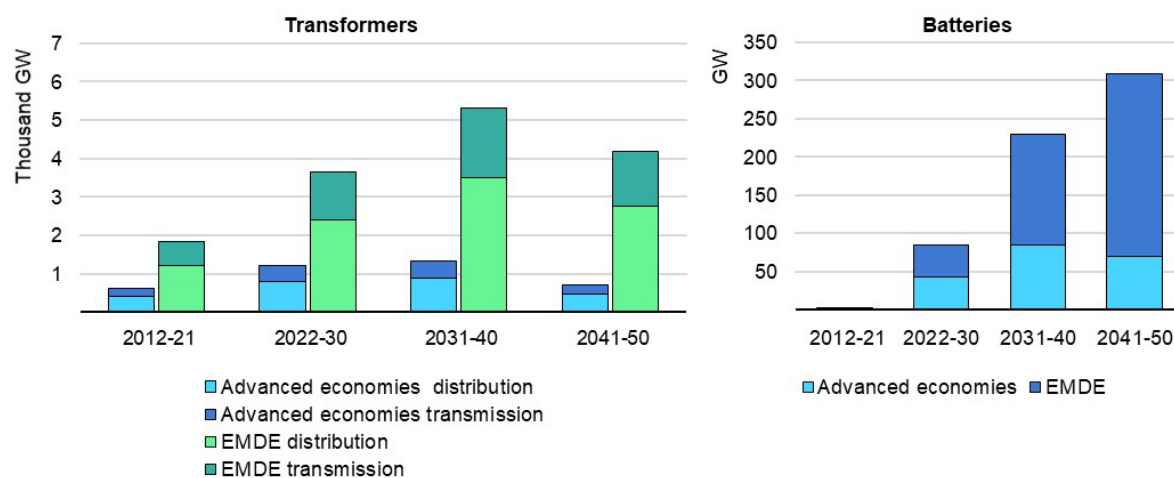

IEA. CC BY 4.0.

Note: EMDE = emerging markets and developing economies.

Driven by increasing electricity demand, capacity additions for transformers and battery storage grow rapidly in the NZE Scenario, especially in emerging economies.

Charging stations for EVs

Suitable access to EV charging equipment is essential to enable widespread electric vehicle deployment. There are two broad categories of chargers:

- **Private chargers.** These are chargers located at residences, workplaces and depots, with power ratings that typically range from 3 kilowatt (kW) to 22 kW. Electricity pricing through these chargers is often similar to residential or commercial tariffs, making them the least costly charging option in most cases. This is currently the primary EV charging method, with an estimated 15 million private charging points worldwide at end-2021.
- **Publicly accessible chargers.** These are street-accessible chargers, located mostly in urban areas such shopping centres and parking garages and along highways. Their power ranges from 11 kW to 350 kW for electric cars. Electricity pricing for public chargers tends to be higher than for private chargers since equipment and grid connection costs have to be recovered. Public charging networks are necessary for EV owners who wish to undertake long-distance journeys or who do not have access to a home charger (such as those living in multifamily residences). There were about 1.8 million public EV charging points worldwide at the end of 2021.

The number of charging points increases rapidly in the NZE Scenario, in line with EV fleet expansion. Lead times to install charging infrastructure vary: home chargers can be installed without any permission if below a given power threshold, while more powerful chargers can usually be approved within weeks in most

countries. For public charging infrastructure, construction time is usually around six months when major grid upgrades are not required but can be as much as 1.5 years if high-voltage infrastructure needs to be built. Permitting time can triple the length of these lead times.

Rising EV charging loads will put growing pressure on power grids. In advanced economies, EV penetration of up to 40% of the fleet can be managed without any major work to the grid, with most modifications involving transformer upgrades to ensure they are voltage-regulated because EV charging loads are generally evenly spread over time (including within the day). As the EV share expands, stress on the grid can become problematic if charging patterns are not well managed. In the NZE Scenario, smart charging technologies and broader grid digitalisation are rolled out rapidly to maintain grid resilience as charging loads increase.

The number of EVs worldwide jumps from 60 million in 2021 to over 700 million in 2030 in the NZE Scenario, requiring average annual investments of USD 30 billion (in 2021 US dollars) in charging facilities over 2022-2030. As the number of EVs on the road increases, each public charger will be used by more vehicles, reducing investment needs. However, the average power rating of public chargers is expected to increase as demand for fast-chargers grows.

Material needs and supply chains

Raw material needs

Demand for materials to make equipment for electricity grids, especially copper and aluminium, soars in the NZE Scenario. The use of copper for transmission lines, distribution grids and transformers increases from an average of 5 million tonnes per year (Mt/year) in 2012-2021 to 6 Mt/year over 2022-2030, levelling off at 12 Mt/year in 2041-2050, while annual aluminium demand grows from 12 Mt/year to 16 Mt/year and 26 Mt/year over the same periods (Figure 5.6). Distribution grids account for around 80% of the copper demand and more than half of the aluminium demand in 2050. The copper used for grids and transformers in 2022-2030 corresponds to almost 20% of global copper production in 2021; the share for aluminium is almost 25%. Aggregate demand for materials to make transformers, including steel, copper, aluminium, transformer oil and insulation materials rises from 9 Mt/year in 2012-2021 to 17 Mt/year in 2022-2030 and more than 23 Mt/year in 2031-2040, before falling back to 17 Mt/year in 2041-2050. Demand for materials to make grid batteries, mostly copper, graphite and vanadium, escalates from just 0.01 Mt/year in 2012-2021 to 0.45 Mt/year in 2021-2030 and more than 2 Mt/year in 2041-2050.

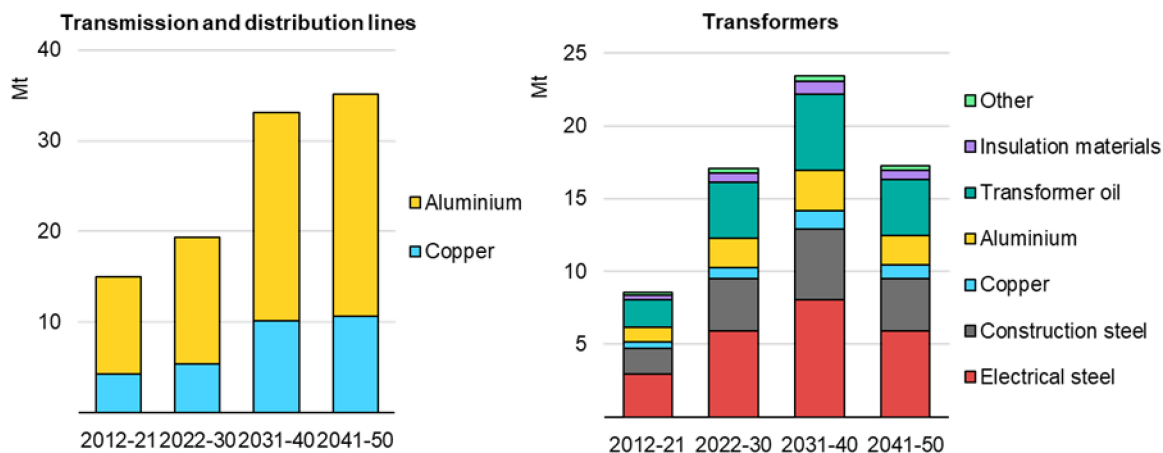
Figure 5.6 Average annual material needs for selected grid technologies in the NZE Scenario

IEA. CC BY 4.0.

Notes: Mt = million tonnes. Material demands for transmission and distribution lines include conductor cables and wires, but not steel for towers and poles. For transmission and distribution lines, aluminium is used for overhead lines and copper for cables.

The demand for materials to make equipment for electricity grids, especially copper and aluminium, soars over the next two decades in the NZE Scenario.

Copper and aluminium are the main materials for making electricity cables and lines. Due to its good electrical conductivity, copper has long been the preferred choice, though it is three times heavier and much more expensive than aluminium. Aluminium has only about 60% of the conductivity of copper, which means much thicker wires are needed. As the conductivity-to-weight ratio of aluminium is better than that of copper, it is usually preferred for overhead power lines, while copper is most often used for underground and subsea cables.

The amount of these materials needed for transmission and distribution lines depends on voltage. Transmission capacity is the product of current and voltage: if voltage is increased with the same current, transmission capacity increases. Current determines the thickness of the conductor as well as the losses, while voltage determines how much insulation is needed – either air for an overhead line or insulating material such as cross-linked polyethylene in the case of a cable. Conductor material and losses can therefore be reduced by increasing the transmission voltage. An overhead transmission line requires around 11 kilogrammes of aluminium per megawatt and per kilometre (kg/MW/km), compared with 65 kg/MW/km for an overhead distribution line with much lower voltage. Underground cables require 101 kg/MW/km of copper for transmission and 438 kg/MW/km for distribution. An HVDC line requires even less metal – around 5 kg/MW/km of aluminium for an overhead line and 29 kg/MW/km of copper for an underground cable (Figure 5.7). HVDC lines require less material

because fewer lines (only one or two) are needed than for a three-phase AC system. In addition, HVDC systems usually run at higher voltages, further reducing material needs relative to AC for the same capacity.

Figure 5.7 Typical material composition of overhead lines and cables by weight, 2021

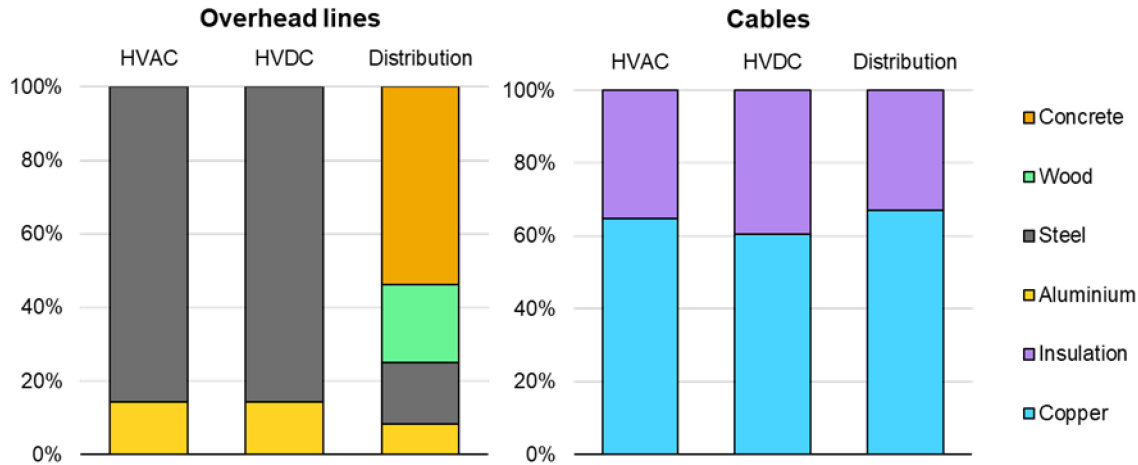

IEA. CC BY 4.0.

Notes: HVAC = high-voltage AC transmission; HVDC = high-voltage DC transmission. Materials in overhead lines include conductors, towers and poles.

Overhead line conductors are made of mainly aluminium (~70%) and some steel (~30%), while the majority of steel used in overhead line systems is for the towers and poles.

By weight, half of the material needed to make a power transformer is steel: two-thirds of which is grain-oriented electrical steel (GOES) with specific magnetic properties and high permeability, and the rest construction steel (Figure 5.8). In the NZE Scenario, demand for GOES for making transformers doubles from nearly 3.0 Mt in 2020 to almost 6 Mt/year in 2020-2030, exceeding today’s manufacturing capacity of 3.8 Mt/year.

Figure 5.8 Typical material composition of transformers and stationary batteries by weight and value, 2021

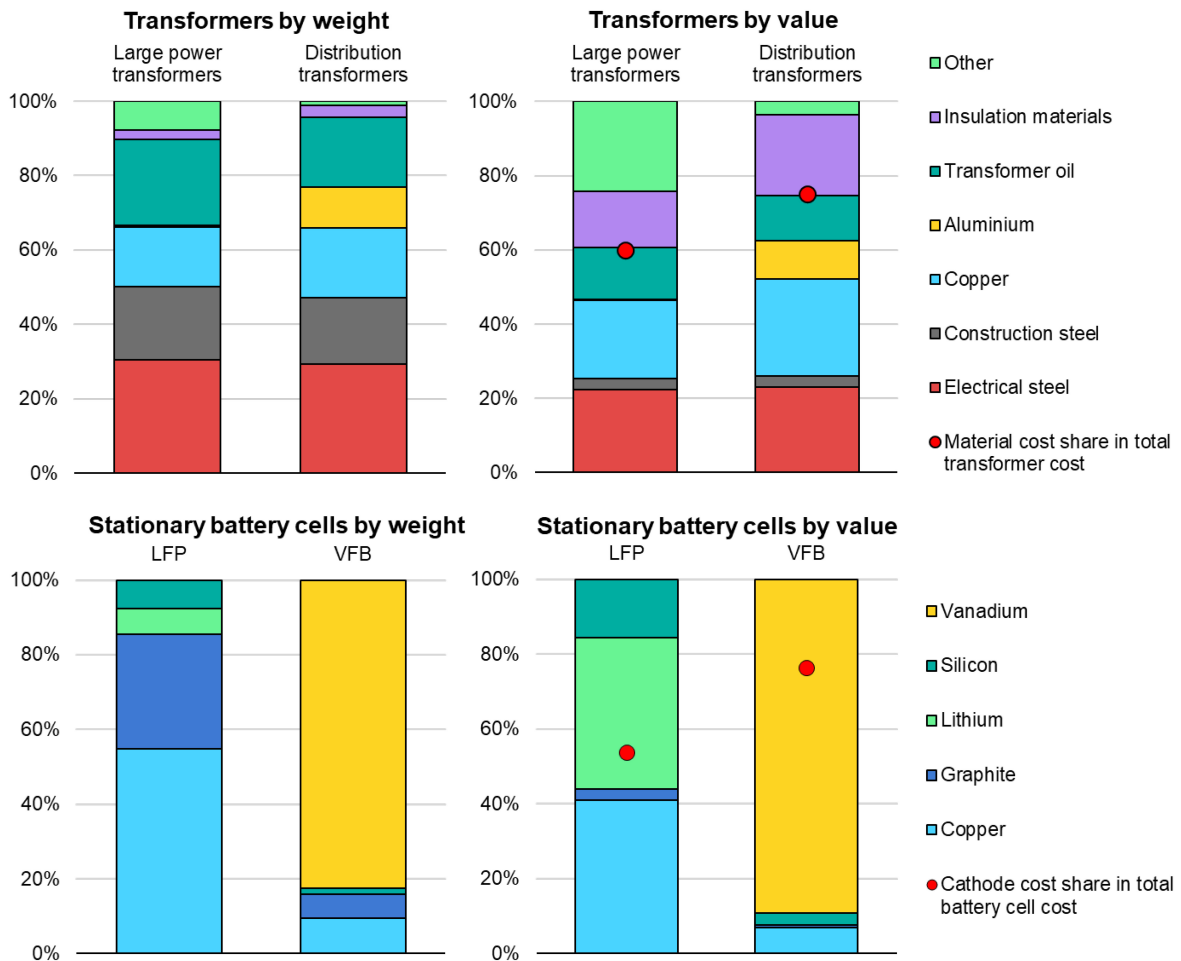

IEA. CC BY 4.0.

Notes: LFP = lithium iron phosphate; VFB = vanadium flow batteries. “Other” includes pressboard, paper, plastics, porcelain and rubber for transformers.

Electrical steel and copper account for around half of the material costs for transformers, while copper alone makes up around 40% of the material cost of an LFP stationary battery.

Other materials needed to make transformers include copper, aluminium, transformer oil for insulation, insulation material, pressboard, paper, plastics, porcelain and rubber. Aluminium is mainly used in low-voltage distribution transformers. Thanks to its good electrical and cooling properties, mineral oil is the main type of oil used in transformers to insulate and cool the transformer windings (copper coils) and core. Accidental fires caused by mineral oil-based transformers and the non-biodegradable nature of such oil have led to the development of bio-based transformer oils, which are non-combustible and non-toxic (GE Grid Solutions, 2017).

Materials are the main cost component for transformers, accounting for 60-75% of the cost of a large power transformer. Copper accounts for around one-quarter of total material costs and GOES for between one-fifth and one-quarter. GOES comes in different quality grades, with highly permeable grades allowing the transformer to be smaller, requiring less oil and reducing electrical losses. Minimum efficiency standards for transformers, such as the Energy Efficiency Program for Certain Commercial and Industrial Equipment in the United States (United States, DOE, 2021; 2022a), and the Ecodesign Directive in the European Union (European Commission, 2019), are pushing the use of higher-quality GOES types, though European manufacturers have warned of shortages. For distribution transformers, the use of amorphous steel instead of GOES can be an alternative to achieve higher transformer efficiencies, but results in larger and heavier transformers compared to transformers using GOES and requires a more labour-intensive manufacturing process.

Lithium-ion (Li-ion) batteries, developed primarily for EVs, currently account for the majority of installed battery capacity in stationary applications, though lithium iron phosphate (LFP) batteries are now the dominant technology for new additions. New battery technologies for stationary applications are under development, notably vanadium flow batteries (VFBs). VFB performance does not degrade for at least 25 years and they can endure a higher number of charging and discharging cycles than Li-ion batteries, though they are too bulky and heavy for EVs. VFBs require fewer raw materials such as nickel and cobalt, but they need vanadium. Today, that metal is largely used in the steel sector, accounting for 92% of the global vanadium demand of 110 kilotonnes (kt) in 2021 (60% in China). Three major raw material sources support vanadium production globally: co-production from steel slag (73%), and extraction from primary resources (17%) and secondary sources (10%) (Bushveld Minerals, 2022). Growth in VFB use for storage applications in the NZE Scenario corresponds to average annual demand of 300 kt of vanadium during 2031-2040 – three times the current level – which could be covered by known reserves of 22-24 Mt (Simandl and Paradis, 2022).

Manufacturers of stationary batteries are also carrying out research and development on sodium-ion batteries, which rely on sodium – a relatively abundant element. Cell design and related component material processing are similar for Li-ion batteries, enabling the use of existing battery manufacturing equipment and techniques. They are expected to become commercially available after 2025.

Equipment manufacturing

There are several suppliers of high-voltage AC and DC cables and overhead lines internationally, including NKT in Denmark, Nexans in France, Südkabel in Germany, Prysmian in Italy, Sumitomo in Japan, General Cable in the United

States, NBO and ZTT in China and LS Cable in Korea. Data on manufacturing capacity for cables and overhead lines are difficult to obtain for some regions. Europe had annual manufacturing capacity of around 11 280 km for HVAC and HVDC cables in 2016, of which 6 550 km are for land and 4 730 km subsea (ENTSO-E and Europacable, 2018).

Most cable manufacturers have plants around the world. Plants are generally located close to demand centres to avoid costly long-distance transport of heavy cables: shipping a 200-km-long cable weighing 10 000 tonnes from Europe to Asia can take approximately one month. Procurement lead times for large HVAC or HVDC cables are around two to four years, since the manufacturing of cables is a time-consuming process and involves a number of sequential operations. For example, making subsea cables involves conductor stranding, insulation extrusion or lapping, sheathing, the jointing of separate cables to a longer one, armouring and testing (ENTSO-E and Europacable, 2018; SKM and ETI, 2010; Worzyk, 2009).

The leading manufacturers of large power transformers are Hitachi Energy (Switzerland), Siemens Energy (Germany), Mitsubishi and Toshiba (Japan), General Electric and Westinghouse (United States), Hyundai Heavy Industries (Korea), Chint and China XD Electric (China) and Compton Greaves (India), together accounting for more than 40% of the global market. The production of medium-voltage and distribution transformers is spread over a much larger number of companies. The steps to manufacture a power transformer involve the building of the core, production of the windings, assembly of the core and windings and production of the tank for the oil, as well as final assembly of the transformer and testing. Large power transformers are extremely heavy, weighing 100-400 tonnes, so transporting them from the factory to the final destination, usually in parts, is a considerable undertaking, accounting for up to one-fifth of the total cost.

GOES is a key material for power transformers. Global manufacturing capacity for GOES was around 3.8 Mt in 2020, though production was only 2.8 Mt due to effects of the Covid-19 pandemic. Manufacturing is limited to a few producers in China, Japan, France, Germany, India, Poland, the Czech Republic, the Russian Federation (hereafter, "Russia"), Brazil, Korea and the United States (Table 5.1). China is the largest market, with estimated annual domestic consumption of 1.33 Mt in 2020, followed by the European Union with 0.23 Mt and the United States with 0.15 Mt (China, Ministry of Commerce, 2021).

Table 5.1 Global grain-oriented steel manufacturing capacity by country and manufacturer, 2020

Country	Capacity (kt/year)	Companies
China	1 780	Baowu, Anshan, Hebei Shougang, TISCO
European Union	400	ThyssenKrupp Electrical Steel, StalProdukt, GO Steel Frydek Mistek
Japan	480	JFE Steel, Nippon Steel & Sumitomo Metal
Korea	300	POSCO
Russia	330	NLMK
United States	300	AK Steel
Other countries	190	Aperam (Brazil), ThyssenKrupp (India)
World	3 780	

Note: kt = kilotonne.

Sources: China, Ministry of Commerce (2021); European Commission (2022a).

Almost 40% of global GOES production was traded internationally in 2020. Five countries – Japan, Russia, China, Korea and Germany – accounted for more than 90% of all GOES exports, reflecting the relatively small number of producing countries. The leading importers were India, Mexico, Türkiye, Italy and Canada, which together were responsible for almost 60% of all GOES imports (Figure 5.9). Several countries have imposed tariffs on GOES imports in response to accusations of dumping. The transformer industry is, however, facing shortages, which are driving up prices: the average international price in September 2022 was 70% above the average for 2020. Sanctions on exports from Russia, which accounted for almost 10% of global production capacity in 2020, is a major reason. Growing demand for non-oriented electrical steel (NOES) for making EV motors, which has led some steel producers to switch part of their production from GOES, is another contributing factor.

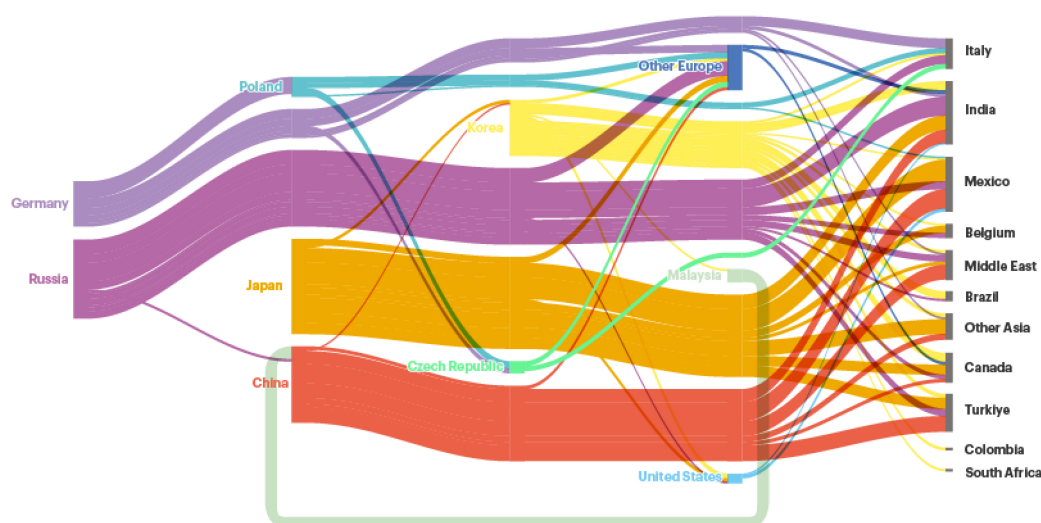
Figure 5.9 Global trade flows of grain-oriented steel by weight, 2020

IEA. CC BY 4.0.

Note: Only trade flows of 4 kilotonnes or larger are shown.

Source: IEA analysis based on CEPII (2022).

Five producers – Japan, Russia, China, Korea and Germany – account for more than 90% of all GOES exports, with India and Mexico being the largest importers.

Around 450 000 transformers with a capacity above 10 megawatt (MW), i.e. including small, medium and large power transformers, were traded globally in 2020, with a total value of USD 3 billion. In monetary terms, China accounted for more than one-quarter of total exports, followed by Korea, Mexico, Germany, Italy and Türkiye (Figure 5.10), with these six countries together making up almost 75% of the total. In monetary terms, the United States was the primary importer of transformers in 2020, receiving more than one-third of all such imports. Mexico was the leading exporter to the United States, with a significant share of Mexican imports of GOES being used to manufacture transformers. Imports of transformers are unsurprisingly concentrated in regions with rapidly growing electricity demand, notably the Middle East and Southeast Asia⁴⁰, which each account for around 10% of all imports.

⁴⁰ Southeast Asia refers here to Brunei Darussalam, Cambodia, Indonesia, Lao People's Democratic Republic, Malaysia, Myanmar, the Philippines, Singapore, Thailand and Viet Nam.

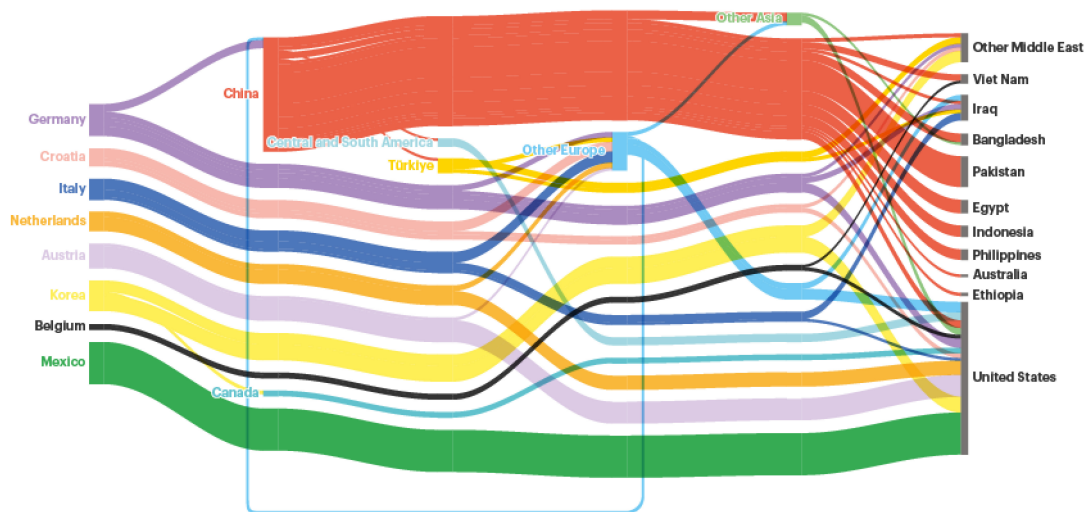
Figure 5.10 Global trade flows of transformers above 10 MW in monetary terms, 2020

IEA. CC BY 4.0.

Note: Only trade flows with values of more than USD 15 million are shown.

Source: IEA analysis based on CEPII (2022).

China is the leading exporter of transformers, particularly to other emerging economies, while the United States is the main importer, principally from Mexico and Europe.

HVDC transmission systems are usually supplied in two parts, the point-to-point lines and the converter stations, often by different companies. The leading producer of converter stations is Hitachi Energy (formerly ABB) in Switzerland, followed by Siemens (Germany) and General Electric (United States), Mitsubishi Electric (Japan), NR Electric and C-EPRI Electric Power Engineering (China) and Bharat Heavy Electricals Limited (India). The main components are converter valves made from high-power semiconductors (insulated-gate bipolar transistors or thyristors), conversion power transformers, measuring instruments and voltage/current transformers, harmonic filters and shunt capacitors, and control systems. Hitachi Energy has its own factory for making power semiconductors, whereas the other suppliers have to source these key components externally from semiconductor manufacturers. Procurement lead times for converter stations are usually around two to three years.

Lead times

Lead times for planning and building the major assets that make up electricity grids can be very long. Average lead times for new overhead transmission lines in Europe and the United States today are around ten years, of which seven are required for planning and permitting, and around three for construction (Figure 5.11). However, some recent projects have taken much longer (up to 13 years). It is usually much quicker to build new generating plants: utility-scale solar PV and

onshore wind projects take three to five years and offshore wind farms up to seven. Long lead times to connect new plants to the grid can slow deployment. In the United States, the average grid connection time for power plants increased from 2.5 years in 2000-2010 to 3.9 years in 2011-2020 (Rand et al., 2022). Planning and building low-voltage distribution lines is faster, varying from six months to two years, depending on the region (Netbeheer Nederland, 2019).

Various factors can reduce the pace of infrastructure project deployment (Box 5.1). Obtaining right-of-way permits and environmental impact assessments and permits contribute to long lead times for transmission projects. Based on completed transmission projects in the United States over 2016-2022, obtaining right-of-way authorisations took 3-11 years and environmental impact assessments 2-9 years (US Permitting Council, 2022). In Europe, permitting times for onshore wind projects vary from three to nine years between countries, and for utility-scale PV the range is one to four years (European Commission, 2021). Public opposition often slows this process. In Germany, the decision to prioritise underground cables over overhead lines for the Südlink transmission project from northern to southern Germany helped increase public acceptance, but it required changes to the planned route, further delaying the permitting process (Energiechronik, 2020).

Although construction of new transmission lines is normally much quicker, supply chain constraints can cause delays. Subsea cables, for example, require cable-laying vessels. The 45 cable-laying vessels in operation worldwide today can lay a total of 4 200-7 000 km of cable per year (depending on the type of project). The current fleet of vessels is sufficient to cover the cable-laying needs for offshore wind deployment up to 2030 in the NZE Scenario, but additional vessels would be needed for any subsea interconnector cables. Procurement times for key equipment must also be taken into account in the planning process for transmission lines. Shortages of materials, particularly GOES, are likely to increase procurement times for power transformers in the near future. In October 2022, utilities in the United States reported that procurement times for distribution transformers had increased from 2-3 months in 2021 to up to about 12 months in 2022, with some utilities reporting lead times of more than three years (APPA, 2022).

Figure 5.11 Average lead times to build new electricity grid assets in Europe and the United States, 2010-2021

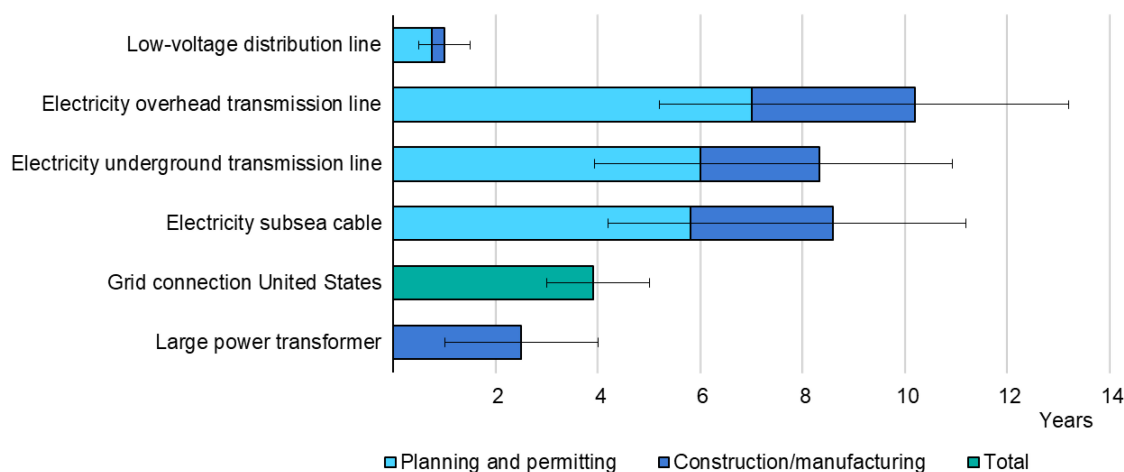

IEA. CC BY 4.0.

Notes: Bars represent average lead times and lines reflect typical ranges based on selected recent projects. The lead time to connect power plants to the grid in the United States is the average for 2011-2020, while lead times for overhead and underground transmission lines as well as subsea cables cover 2010-2021. The construction time for large power transformers is based on industry sources.

Sources: IEA research; US Permitting Council (2022); Rand et al. (2022).

Planning and permitting of new transmission lines in Europe and the United States typically takes six to seven years, while the construction itself requires only two to three.

Box 5.1 Why do energy infrastructure projects take so long?

Lead times associated with infrastructure projects can be very long, ranging from 8 to 13 years for transmission grids, potentially up to 3-12 years for hydrogen infrastructure, and up to 10 years for CO₂. Reducing these times will be critical to speed up deployment. Four main factors determine how long it takes to deploy a project: project economics, the complexity of permitting procedures, socio-political support and technical constraints.

Depending on the business model they rely on, infrastructure projects of all types (transport, transmission, distribution and storage) can face **financing** difficulties. In the case of electricity transmission and distribution, projects are often operated following a regulated-asset-base business model, which limits revenue and returns on investment. Many advanced economies have put in place arrangements to support the financing of these projects, but the high cost of capital and difficulties attracting private investment are often a problem in emerging economies. Financing the development of newer infrastructure types, such as CO₂ or hydrogen pipelines and storage, can be especially difficult because markets for the services they provide are nascent and it is unclear under which regulations and business models

they will operate. Governments can reduce investment risks for these capital-intensive projects through measures such as low-interest loans or loan guarantees. Developing business models for hydrogen or CO₂ infrastructure can reduce investment risks and attract private investments (IEA, 2022a).

The time needed to obtain **permits and approvals** to build clean energy infrastructure varies by infrastructure type, but it is on average up to six years for pipelines (using natural gas pipelines as a proxy) and transmission grids. The complexity of these projects, which can involve lines crossing several jurisdictions, explains why they take so long. A large number of studies, plans and reports often have to be provided to respect various regulations. For new infrastructure types, including pipelines and storage sites for hydrogen or CO₂ as well as port facilities for CO₂ or hydrogen, it is not always clear which regulator should be in charge of permitting, and globally only a limited number of regulators have experience with these projects. As a result, first-of-a-kind projects usually involve longer permitting times. They can be reduced by various measures, such as improving co-ordination among the government agencies involved, providing clear responsibilities and timelines as well as adequate staff, and ensuring that regulations are fit for purpose and applicable to new energy infrastructure types.

Efforts to improve permitting processes for infrastructure and renewable energy technologies are currently under way in several countries. While revisions to the EU Renewable Energy Directive are still in the legal process, the EU Council has agreed on a temporary framework to set deadlines for granting permits for rooftop solar PV, heat pumps and the repowering of existing renewable power plants as well as to provide the possibility for simplified assessment of renewable energy projects (European Council, 2022). The US government recently presented a Permitting Action Plan to accelerate federal permitting and environmental reviews for infrastructure projects funded through the Infrastructure Investment and Jobs Act (The White House, 2022).

A lack of **socio-political support**, including a failure to achieve broad consensus among political parties and countries on long-term goals and a strategic vision for energy infrastructure, can lead to delays, especially when there is a change of government. Opposition from sections of the public, including landowners, environmentalists and indigenous groups, can also delay or halt projects, especially if communication and consultation are inadequate. Engaging stakeholders around the project route or site early and often, with appropriate communication strategies as well as long-term planning with active support from different levels of government and international co-operation for cross-border infrastructure projects, can smoothen project development.

Bottlenecks in supply and technical constraints can also cause delays. Installing transmission lines and pipelines and building underground storage facilities requires specialised equipment and expertise, which can be subject to

bottlenecks and supply shortages. This is particularly true for the offshore laying of infrastructure, for which specialised vessels and platforms are usually booked more than a year in advance. Construction workers usually require specific certifications and training (e.g. for working offshore or for welding pipes). Weather, terrain and ease of access can also affect the construction of infrastructure and cause project delays. Governments and the private sector need to support training programmes and the reskilling and/or upskilling of fossil energy sector workers that may lose their jobs as the energy transition progresses.

Repurposing existing infrastructure for hydrogen and CO₂ use can involve shorter lead times as well as lower overall infrastructure investment costs (see Focus on Repurposing Existing Infrastructure below).

Sources: IEA (2022a); European Council (2022); The White House (2022).

End of life

Network equipment normally lasts a long time and can usually be reused or recycled to a large degree. High-voltage overhead lines usually last at least 40 years (much longer if well maintained), but are often replaced sooner due to the need to increase transmission capacity (difficulties in gaining right-of-way access mean that it is generally much easier to use existing routes than to build new lines). For distribution lines with poles made of material other than steel, lifetimes rarely exceed 40 years, especially in the case of wooden poles, which tend to rot. Every part of the material used for overhead lines, including the conductor, is easy to reclaim and recycle. In some cases, masts and pylons coated with anticorrosion paint containing lead or asbestos may need to be recycled by a certified company.

High-voltage cables have a normal lifetime of 40 years, though some manufacturers claim 60 years. At the end of a cable's lifetime, a decision needs to be made whether to leave it in the ground or take it out, which can be difficult and costly. In contrast to the new generation of cross-linked polyethylene cables, many old oil-filled cables contain hazardous materials that can pollute the soil for a long time in the event of leakage, so usually need to be removed. The cable conductor, which consists of copper or aluminium, as well as polyethylene used as insulation material, can be also recycled.

The normal lifetime of a power transformer is around 40 years, or 360 000 operating hours, though this can vary according to loading conditions and ambient temperatures. In some countries, the transformer fleet is relatively old. For example, in the United States the average age of large power transformers in operation is 38-40 years. More than 70% of them are more than 25 years old and

some are more than 70 years old (United States, DOE, 2022b). Around three-quarters of a transformer's materials can be recycled, especially the steel, copper and oil.

As with EV batteries, stationary batteries can be recycled to recover valuable materials such as cobalt, nickel, iron, graphite, lithium and manganese from the cathode (see Chapter 3). The manufacturing costs for a new cell can be 5-30% lower when recycled cathode materials are used (NREL, 2021). Energy use and emissions along the supply chain are also lower when less raw material needs to be extracted and processed. However, the processes used to recover and recycle the various materials in batteries are complex and expensive.

Energy needs and emissions

Direct energy needs for manufacturing grid technologies, excluding the energy needed to mine and process the materials required to manufacture these technologies, are relatively small. Manufacturing transmission and distribution grid lines and cables used about 50 PJ of energy inputs worldwide in 2021 (equal to around 0.01% of global final energy consumption), two-thirds in the form of electricity and one-third natural gas. In the NZE Scenario, energy demand roughly doubles by 2050 to 100 PJ. The amount of energy embedded in the materials used to make these assets, mainly copper and aluminium, is somewhat higher – about 150 PJ for copper and 570 PJ for aluminium in 2021. These amounts increase to 340 PJ for copper and more than 1 000 PJ for aluminium in 2050. Including this indirect energy use, the total energy needed to make lines and cables equals about 0.4% of total final electricity consumption in 2050 compared with 0.2% in 2021.

Energy use is similar for transformers. Around 290 PJ were consumed globally to manufacture transformers in 2021, and in the NZE Scenario this amount increases to 570 PJ in 2030 and to 780 PJ in 2040 before falling to 570 PJ in 2050. Energy required to extract the materials used to make transformers is in a similar range: 300 PJ in 2021 and 560 PJ in 2030 and 2050.

The operation of transmission and distribution grids themselves also consumes energy. Transformers have efficiencies in the range of 95-99.7% depending on type and size, with higher-grade GOES improving efficiency and saving money, though these transformers cost more to manufacture. Overall, grid losses worldwide amounted to 7% of electricity generation, emitting 1 000 Mt of CO₂ (or 2.6% of global energy sector emissions) in 2021. Those emissions fall rapidly in the NZE Scenario as electricity generation is decarbonised. Improving grid efficiency also reduces emissions as well as the need to build new power plants and procure the associated materials. Average global grid losses drop from 7% in

2021 to 5.6% in 2050, resulting in cumulative material savings of 920 kt of copper (4% of global production in 2021), 155 kt of nickel (6%) and 470 kt of silicon (6%) over 2022-2050.

Hydrogen transport and storage

Technology options

Today, hydrogen is produced mostly close to where it is used and supplied to captive consumers. As demand increases, there will be a stronger economic case for producing low-emission hydrogen in areas with good renewable energy resources, significantly increasing transport needs to connect production sites to demand centres. Where feasible, hydrogen will generally be transported by onshore or offshore pipelines, as it is the most efficient and affordable option for relatively short distances. Where dedicated pipelines are not feasible due to relatively low volumetric flows and short distances, hydrogen can be transported as compressed gas in multi-element gas container trailers or as liquefied hydrogen in cryogenic thermo-insulated vessel trailers. Depending on transport capacity, for distances of more than 2 000-2 500 km, seaborne transportation may be the least expensive option, as is generally the case for natural gas (IEA, 2022b).

Hydrogen pipelines

As low-emission hydrogen production volumes increase and transport distances expand, a network of hydrogen pipelines will need to be developed to connect areas with good resources for production to storage sites and demand centres. As with natural gas, pipeline networks with large transmission trunklines can efficiently transport large volumes of hydrogen over hundreds of kilometres (Figure 5.12). Experience gained over the last century in building and operating natural gas pipelines will be of great benefit to develop hydrogen lines. More than 1.2 million km of natural gas transmission pipelines have been installed worldwide (IEA, 2022b), and approximately another 200 000 km are under construction or in pre-construction development (Langenbrunner, Joly and Aitken, 2022). There is also enormous potential to repurpose existing gas pipelines, which could avoid decommissioning them before the end of their technical lifetime and reduce new material needs, lowering costs significantly and benefitting the environment (see Focus on Repurposing Existing Infrastructure below). Blending hydrogen into natural gas streams could be an interim strategy to kick-start hydrogen production before demand is high enough to justify investing in dedicated hydrogen pipelines.

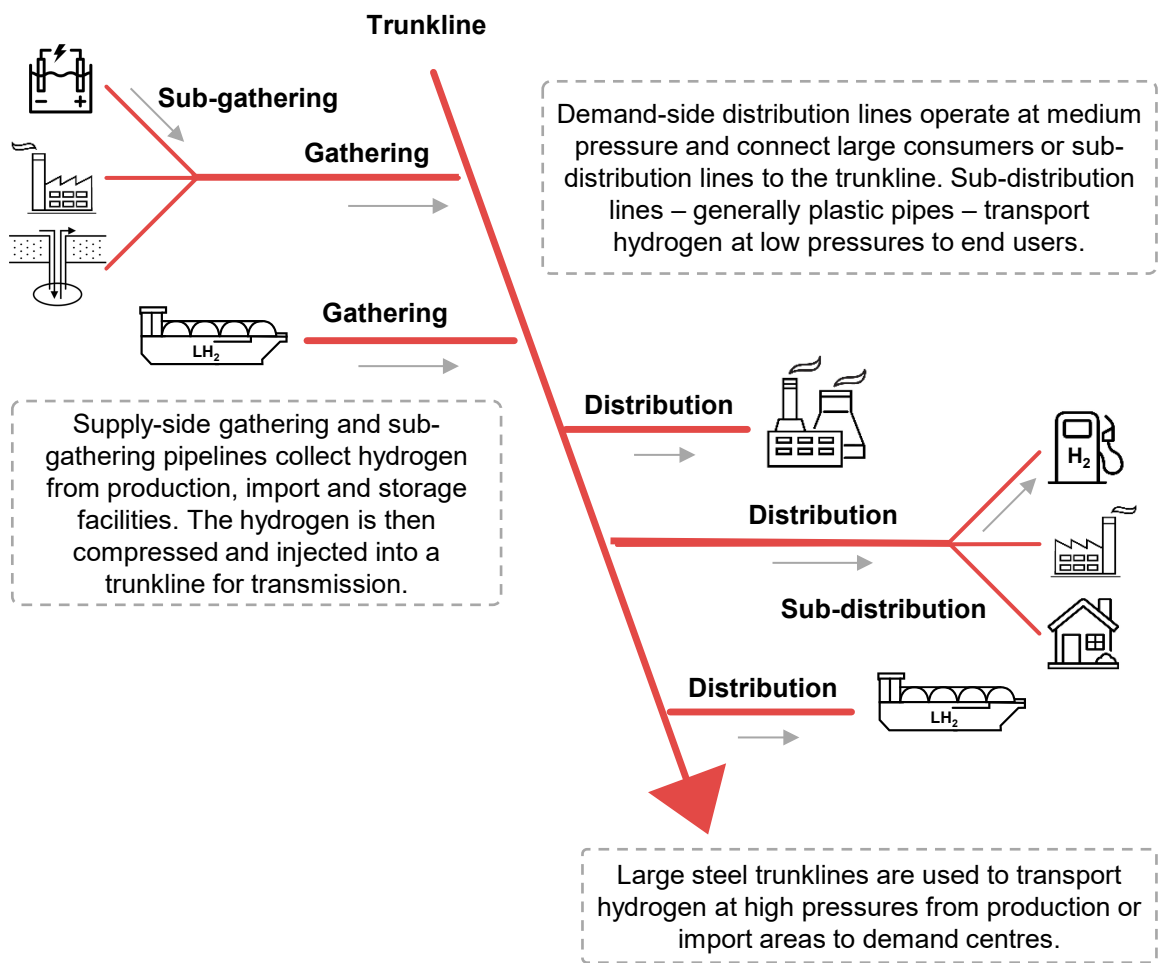
Figure 5.12 Hydrogen pipeline network configuration

IEA. CC BY 4.0.

Note: This chapter assesses only trunklines and large distribution hydrogen pipelines (usually exceeding 20 inches or 500 millimetres in diameter), as the characteristics of gathering and distribution lines are largely project-dependent.

As with natural gas, pipeline networks with large transmission trunklines can efficiently transport large volumes of hydrogen over hundreds of kilometres.

Hydrogen shipping

Hydrogen is more difficult to store and transport than natural gas because it is less dense and has a low boiling point. One cubic metre of hydrogen contains only one-third the energy of a cubic metre of natural gas at the same pressure and temperature. In addition, hydrogen's boiling point (-253°C) is lower than that of natural gas (-162°C). For long-distance transportation, hydrogen must be converted to a denser form, either through liquefaction or conversion into a

chemical carrier that can be transported more easily (Figure 5.13).⁴¹ Potential carriers include ammonia, liquid organic hydrogen carriers (LOHCs) – organic compounds that can absorb and release hydrogen through chemical reactions⁴² – and synthetic hydrocarbon fuels (see Chapter 4). It could also be shipped in solid form, such as hot briquetted iron⁴³ for steel manufacturers.

Figure 5.13 Technological pathways for long-distance transport for the supply of hydrogen and ammonia by tanker

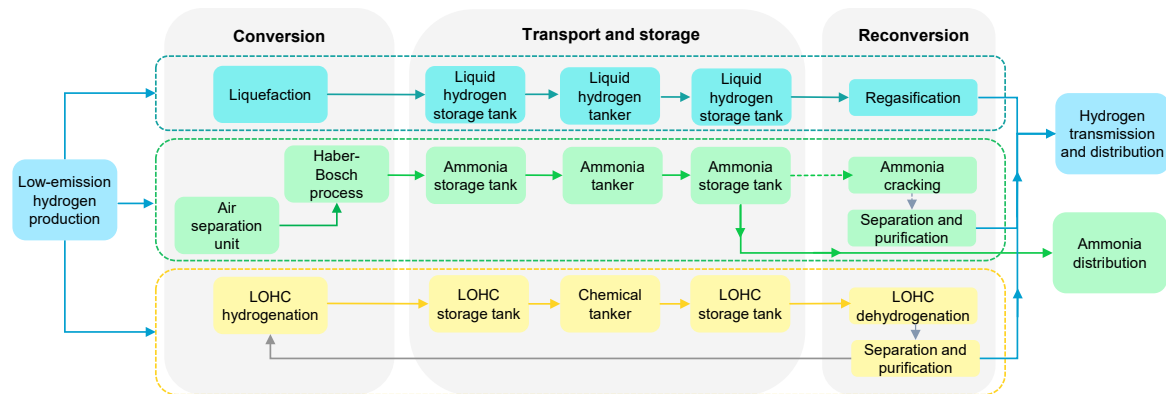

IEA. CC BY 4.0.

Note: LOHC = liquid organic hydrogen carrier.

Delivering hydrogen over long distances requires its conversion to a denser form through liquefaction, or to a chemical carrier such as ammonia or LOHC.

How hydrogen is used at its destination will determine the most appropriate way to transport and store it. If hydrogen is transported as a chemical carrier and converted back to hydrogen, energy losses can be considerable using current technologies, though efficiency is expected to increase through future innovation (see Energy Needs and Emissions below). When hydrogen is converted into a synthetic hydrocarbon fuel such as methane, methanol or diesel, CO₂ is a required input (see Chapter 4). Since the resulting fuel or feedstock is compatible with existing oil and natural gas pipeline, shipping and storage infrastructure and can be used in established end-use applications, synthetic hydrocarbon fuels are not discussed in this section.

⁴¹ Companies such as Australia's Provaris and Norway's Gen2 Energy and Sirius Design & Integration are also considering shipping compressed hydrogen (IEA, 2022b). It could be an alternative to liquefied hydrogen, particularly for shorter distances.

⁴² Two companies – Chiyoda (Japan) and Hydrogenious LOHC (Germany) – are developing LOHC technology. It has already been proven in a few demonstration projects, including the AHEAD project to transport hydrogen as methylcyclohexane from Brunei Darussalam to Japan (Chiyoda) and the HySTOC project to transport hydrogen as dibenzyltoluene in Finland.

⁴³ Hot briquetted iron refers to direct reduced iron that has been compacted at a temperature above 650°C into pillow-shaped high-density briquettes to facilitate handling.

Hydrogen storage

As hydrogen supply expands, transmission networks will need to be complemented by underground geological storage facilities to balance supply fluctuations resulting from electrolysers using variable renewable electricity and from seasonal changes in demand, as well as to bolster energy security in the event of supply disruptions. Global natural gas underground storage capacity is equivalent to approximately 11% of annual gas demand, but in some regions, such as in Europe, it reaches 25%, as it is used to cover seasonal rises in heating demand. Hydrogen demand is expected to be less seasonal than that of gas, but pronounced fluctuations in variable renewable energy generation will require measures to create a more stable hydrogen supply for downstream uses, with flexible hydrogen storage being an important option. This will not only allow supply to match demand but will minimise the oversizing of trade infrastructure and technologies for the production of hydrogen-derived fuels, allowing them to operate at higher full load hours throughout the year to keep costs down.

Developing a new underground gas storage facility can take more than a decade and requires considerable investment. Geological conditions determine development potential, which can be limited in some areas. Alternatively, hydrogen could be stored on a small or large scale as a liquid carrier such as ammonia, methanol or an LOHC, with the latter even using existing petrochemical storage tanks at ports and hubs.

Hydrogen infrastructure needs in the NZE Scenario

Global hydrogen production reached 94 Mt in 2021, containing energy equal to about 2.6% of final energy consumption, most of which was used in refining and in the industry sector (IEA, 2022b). Governments around the world have so far pledged to produce around 125 Mt of hydrogen in 2030 in total – about 50 Mt short of that needed to be on track with the NZE Scenario. Low-emission hydrogen made up less than 1% of the total supply of hydrogen in 2021, a share that rises to more than 50% in 2030 and close to 100% in 2050 in the NZE Scenario. Hydrogen demand by 2050 is equivalent to almost 40% of today's demand for natural gas on an energy basis, and final consumption of hydrogen and hydrogen-derived fuels is equivalent to about 9% of global final energy consumption in 2050 (Figure 5.14). Three-quarters of the hydrogen consumed in 2050 comes from merchant producers, compared with just 7% in 2021. Hydrogen and hydrogen-derived fuels are used by 2050 widely in the industry sector; as a transport fuel in shipping, aviation and heavy road freight; and as electricity storage.

Figure 5.14 Global natural gas and hydrogen supplies in the NZE Scenario

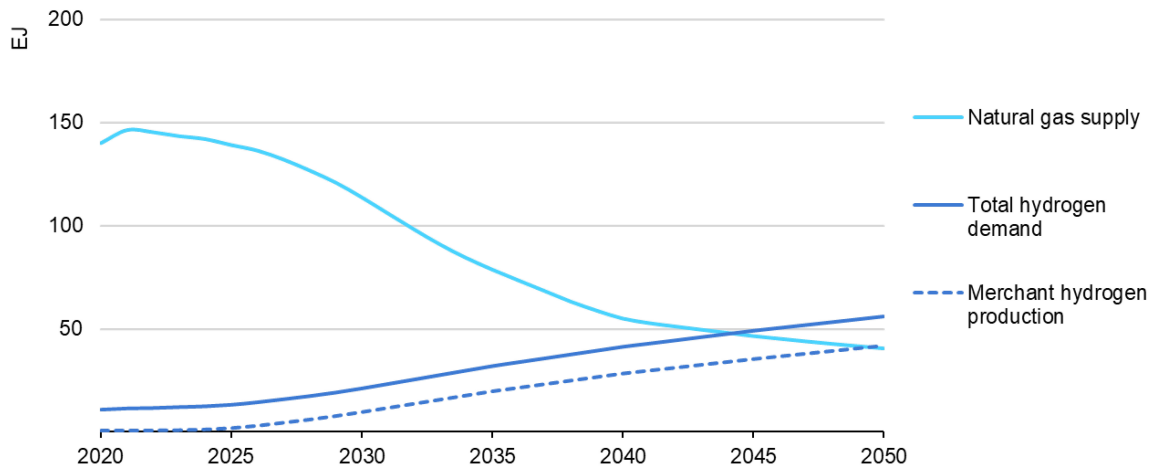

IEA. CC BY 4.0.

Note: EJ = exajoule.

Hydrogen supply in the NZE Scenario surpasses that of gas in 2045 and by 2050 is equivalent to 40% of the current natural gas supply, 75% of it from merchant producers.

The NZE Scenario calls for substantial investments in hydrogen pipelines, tankers for shipping liquefied hydrogen (LH₂), hydrogen carriers, related port terminals and large-scale underground storage facilities (Figure 5.15).

Figure 5.15 Average annual global investment in hydrogen and natural gas infrastructure in the NZE Scenario

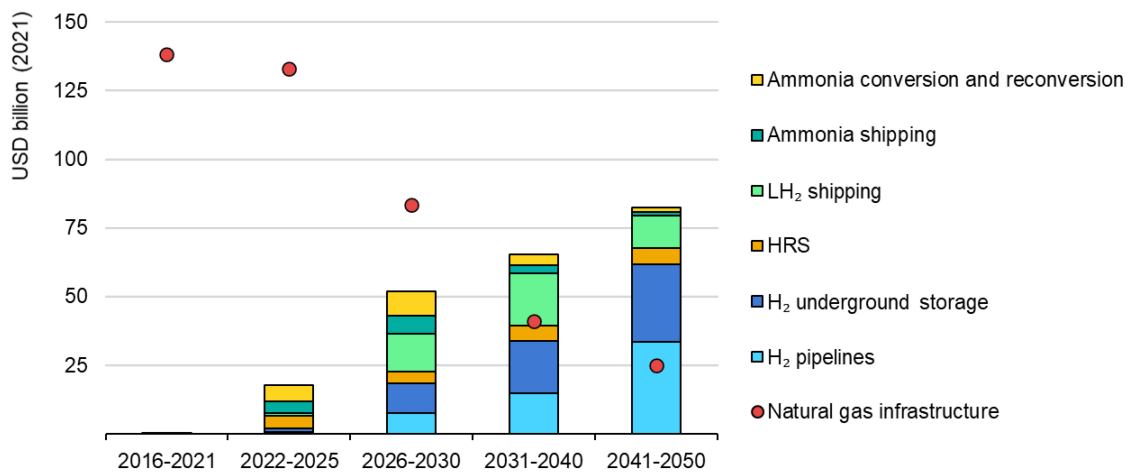

IEA. CC BY 4.0.

Notes: LH₂ = liquefied hydrogen; HRS = hydrogen refuelling station. Investments in LH₂ shipping are for liquefaction facilities, storage tanks at export and import terminals, and LH₂ tankers. Investments in ammonia shipping are for storage tanks at export and import terminals, and ammonia tankers. Ammonia conversion includes the costs associated with converting hydrogen to ammonia using the Haber-Bosch process and reconversion to hydrogen using ammonia cracking, only when hydrogen in the form of H₂ is delivered. Investments in natural gas infrastructure include transmission and distribution pipelines, liquefaction and regasification terminals and liquefied natural gas tankers.

In the NZE Scenario, hydrogen infrastructure requires annual investments of USD 52 billion in 2026-2030 and USD 82 billion in 2041-2050, mostly for pipelines and storage.

Global annual investments reach on average more than USD 50 billion (in 2021 US dollars) in 2026-2030 (equal to almost 40% of current annual spending on natural gas transport infrastructure and more than 60% of what will be spent in 2026-2030) and more than USD 80 billion by 2041-2050 – more than triple what will be needed by then for natural gas transport infrastructure.

Hydrogen pipelines

About 2 600 km of hydrogen pipelines are currently operating in the United States, 2 000 km in Europe (IEA, 2022b), 400 km in China (Wu et al., 2022) and 200 km in Korea (Stangarone, 2021). They are generally owned by merchant hydrogen producers and are located close to large hydrogen users such as petroleum refineries and chemical plants. The need for hydrogen transmission infrastructure increases considerably in the NZE Scenario, reaching around 15 000 km in 2030 and 200 000 km by 2050⁴⁴ (Figure 5.16), including new and repurposed pipelines.

Figure 5.16 Global hydrogen transmission pipeline length in the NZE Scenario

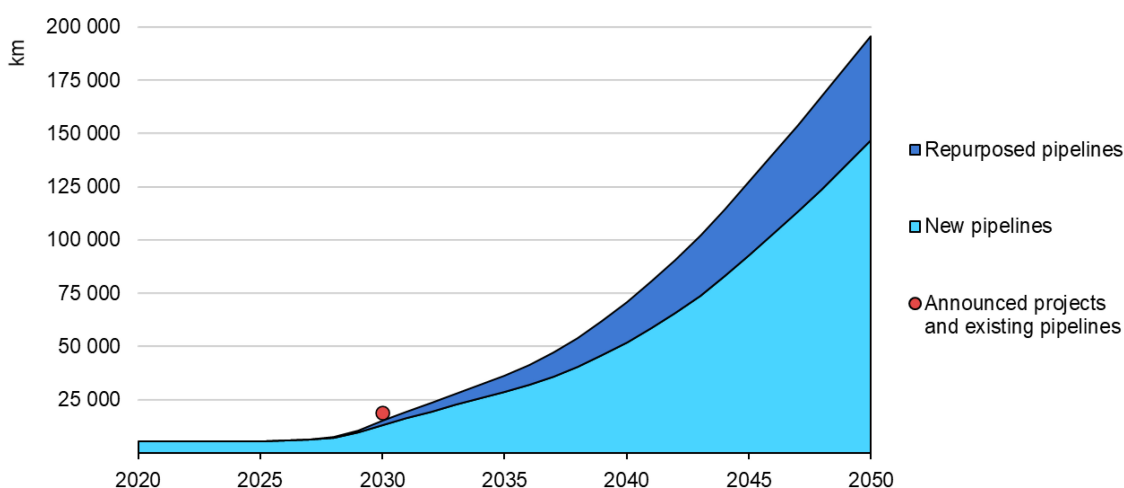

IEA. CC BY 4.0.

Notes: km = kilometre. Pipelines are assumed to have a weighted average capacity of 6.9 GW, corresponding to a mix of 48-inch (~1 200 mm, 12.7 GW), 36-inch (~900 mm, 3.6 GW) and 20-inch (~500 mm, 0.9 GW) pipelines operating at 75% of their design capacity for 5 000 full-load hours.

Hydrogen transmission infrastructure expands rapidly in the NZE Scenario to reach 200 000 km in 2050, evolving from a few small networks to interregional trunklines.

The length of the network in 2050 is considerably less than the more than 1.2 million km of natural gas pipelines in operation today, as hydrogen demand in 2050 is much smaller (approximately 40% of today's demand for natural gas, in energy terms). In addition, part of the hydrogen will be used to produce hydrogen-

⁴⁴ It is assumed that 42% of the length of new pipelines are of 48-inch diameter, 38% are 36-inch and 20% are 20-inch.

derived fuels that will not require hydrogen pipelines. Hydrogen transmission evolves from small pipelines to large regional and interregional trunklines, moving large flows of hydrogen over long distances from areas with good resources for low-emission hydrogen production and storage to demand centres.

Global annual additions of new hydrogen pipelines rise to around 3 500 km in 2030 and 11 500 km in 2050. Natural gas pipelines repurposed for hydrogen make up one-quarter of all hydrogen pipelines in 2050, though the share is much higher in some regions, including Europe, where it reaches half. Roughly 13 500 km of hydrogen pipelines, around half of them repurposed natural gas pipelines that could be available by 2030, are currently under consideration (IEA, 2022b).

Although hydrogen can be transported through steel pipelines in much the same way as natural gas, there are some additional technical difficulties. Unlike natural gas, hydrogen may have a detrimental effect on the integrity of the pipeline due to embrittlement,⁴⁵ which can influence the fatigue behaviour of the pipeline material, accelerating crack growth and reducing its lifetime. Hydrogen pipeline design will need to follow certain codes under expert judgement. The American standard, ASME B31.12, is currently the only one to provide specific requirements for hydrogen.⁴⁶ It imposes stricter rules than for natural gas pipelines to lower the risk of embrittlement, including some limitations on the use of high-strength steels unless subject to testing (Monsma, 2022).⁴⁷ The embrittlement risk affects how the pipeline will be operated, with less flexibility permitted in order to minimise pressure swings, such as from cyclic loading and linepack.⁴⁸ Hydrogen transmission pipelines built in upcoming decades will have markedly different characteristics from today's pipelines to overcome these problems (Table 5.2).

Compression requirements are different for hydrogen pipelines than for natural gas pipelines. On average, a transmission pipeline can transport 10-20% less energy as hydrogen than as natural gas for a similar pressure drop, assuming that the velocity of hydrogen is approximately three times higher (González Díez et al., 2022). More turbines or motors and more powerful compressors are required to handle the larger volumes (see Compressors for Hydrogen Transmission and Storage below).

⁴⁵ Hydrogen embrittlement is a metal's loss of ductility, i.e. the material's ability to be deformed without breaking, and a reduction of its loadbearing capability. The absorption of hydrogen atoms or molecules by the metal results in material separation (cracking) and, ultimately, embrittlement.

⁴⁶ Many existing codes are under revision to add hydrogen-related requirements.

⁴⁷ Low-strength steels exposed to hydrogen generally retain high levels of ductility, while higher-strength steels may have reduced ductility, increasing the risk of embrittlement. Higher-strength steel allows the wall to be thinner for the same operating pressure, reducing logistical and construction work, such as welding.

⁴⁸ Linepack refers to storing gas in a pipeline by compressing it, increasing the pressure of the pipeline. The amount of gas injected into a pipeline may differ from the amount of gas withdrawn at a specific time, providing short-term operational flexibility to match supply with demand.

Table 5.2 Characteristics of existing hydrogen pipelines and desired features of new ones

Objective	Characteristics of existing H ₂ pipelines	Features of new H ₂ pipelines
Increase H ₂ carrying capacity	Largest pipelines have 18-inch diameter	Bigger pipelines, e.g. with ~36-48-inch diameters
Decrease pipeline investment costs - minimise wall thickness	Low steel grades are used, generally below X52*	Higher steel grades are used to reduce the amount of steel needed
Make operations more flexible	Loads are static	Pipelines can withstand pressure swings resulting from cyclic loading and linepack

*X52 is a grade of steel widely used for oil and gas pipelines. The two-digit number following the "X" indicates the minimum yield strength of the pipeline (in thousand psi [pounds per square inch]).

Note: The desired characteristics of new hydrogen pipelines are assumed to meet the objectives without affecting the integrity of the pipeline and without increasing the risk of embrittlement.

Hydrogen shipping

Exporting hydrogen by ship will be essential for some countries to take advantage of low-cost opportunities to produce low-emission hydrogen, while other countries will have to rely on imports to cover their hydrogen needs. Shipping hydrogen in the form of LH₂ is, however, a complex task, given its low volumetric density and low liquefaction temperature. While shipping hydrogen in the form of ammonia or LOHC over long distances can be done with existing tanker technologies, if reconversion to hydrogen at the import location is needed, the overall efficiency would be 60-70%⁴⁹, as energy consumption during the last stage is relatively significant.

In the NZE Scenario, around 20 Mt of low-emission merchant hydrogen is traded in 2030,⁵⁰ the majority assumed to be in the form of LH₂ or ammonia, with around 73 Mt traded in 2050, equal to almost 21% of global merchant hydrogen demand (Figure 5.17). In 2050, 75% of interregional⁵¹ trade of hydrogen and hydrogen-derived fuels is in the form of LH₂ or ammonia (NH₃). Hydrogen is also traded as synthetic liquid fuel, primarily for aviation, corresponding to one-third of synthetic kerosene demand in 2050.

⁴⁹ Overall efficiency of hydrogen transport refers to total energy consumed to convert hydrogen to a higher-density carrier, store it, ship it and reconvert it to deliver gaseous hydrogen.

⁵⁰ The NZE Scenario covers interregional trade of gaseous hydrogen by pipeline and as LH₂ by ship, as well as shipments of ammonia and synthetic liquid fuels. Other hydrogen carriers, such as LOHC, have not yet been explicitly modelled (IEA, 2022c).

⁵¹ Interregional trade refers to the transport of hydrogen and hydrogen-derived fuels among regions covered by the Global Energy and Climate Model, but not among countries within the same region.

Figure 5.17 Global production of low-emission merchant hydrogen and interregional trade in the NZE Scenario

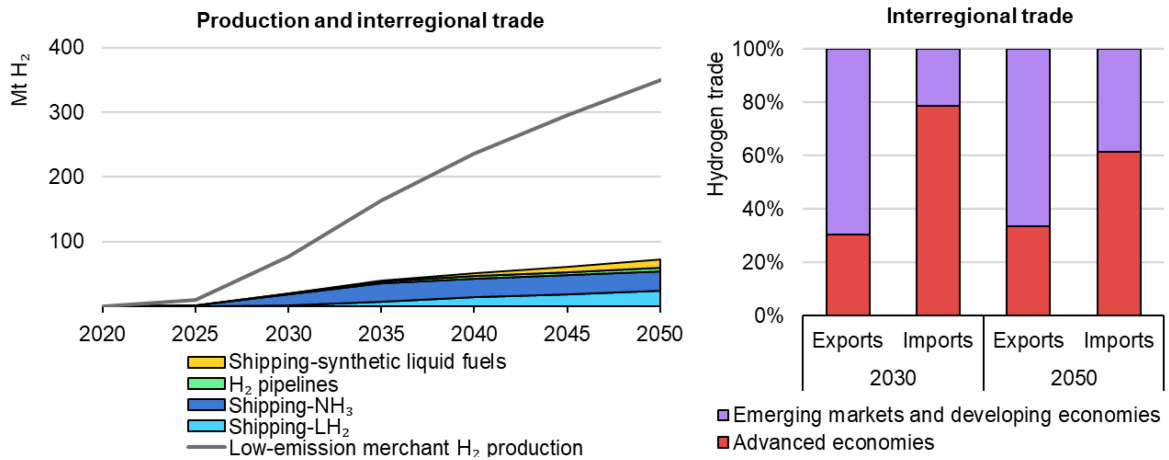

IEA. CC BY 4.0.

Notes: Mt H₂ = million tonnes of hydrogen; LH₂ = liquefied hydrogen; NH₃ = ammonia. Interregional trade is based on regions modelled in the NZE Scenario. Trade in LOHC is not explicitly modelled in the NZE Scenario.

Some 16% of global merchant hydrogen supply is shipped as LH₂ or ammonia in 2050, with more than 65% of exports coming from emerging economies in the NZE Scenario.

The projected pace of global expansion in LH₂ and ammonia shipping in the NZE Scenario is even greater than liquefied natural gas (LNG) growth during the first 25 years of its development, which started in the mid-1970s. By 2030, LH₂ and ammonia shipping is already equivalent to more than 10% of current LNG trade in energy terms; this share rises to one-third by 2050 (Figure 5.18). Expansion in hydrogen shipping will require the construction of many tankers as well as export terminal facilities. Kick-starting hydrogen trade in the next few years will hinge on the commercialisation of emerging technologies for hydrogen transport and conversion, notably tankers for LH₂, and the development of codes and regulations for the bulk transport of liquefied hydrogen and its use as a fuel.

Hydrogen shipped as LH₂ or ammonia is less energy-dense in volumetric terms than LNG, so infrastructure requirements are greater in terms of space at port facilities and number of ships. LH₂ tankers that are to be commercialised by the end of the current decade are likely to be similar in volume to LNG tankers, and ammonia tankers will be half as big, with both carrying one-third of the energy content per shipment (Figure 5.19).

Figure 5.18 Interregional trade and infrastructure for shipping low-emission hydrogen in the NZE Scenario compared with historical LNG trade

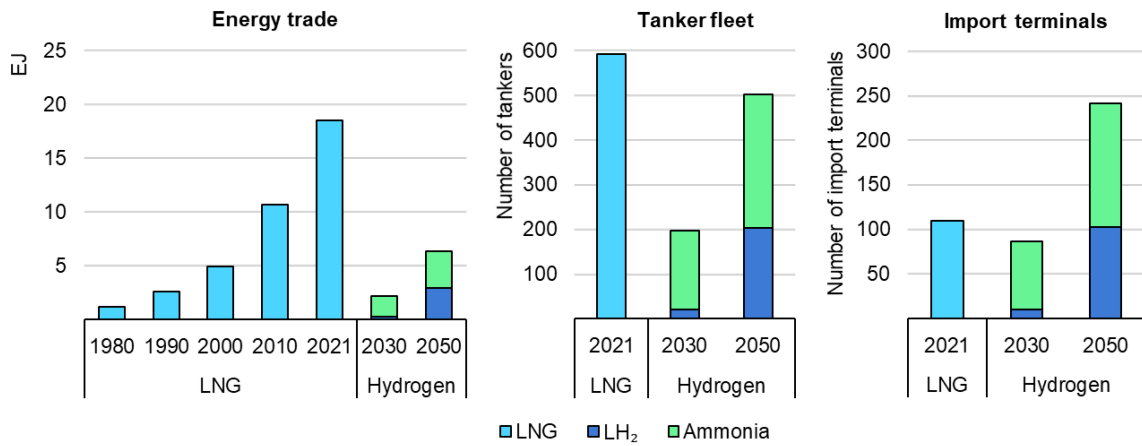

IEA. CC BY 4.0.

Notes: EJ = exajoule; LNG = liquefied natural gas; LH₂ = liquefied hydrogen. For the LNG tanker count, small and medium-sized tankers, icebreakers and bunkering vessels are not included. Hydrogen traded as an LOHC is not explicitly modelled in the NZE Scenario.

While hydrogen shipped as LH₂ or NH₃ in 2050 in the NZE Scenario is equal to one-third of today’s LNG trade in energy terms, their lower density requires almost as many tankers.

Figure 5.19 Tanker capacity in energy and volume terms by energy carrier type in the NZE Scenario, 2030

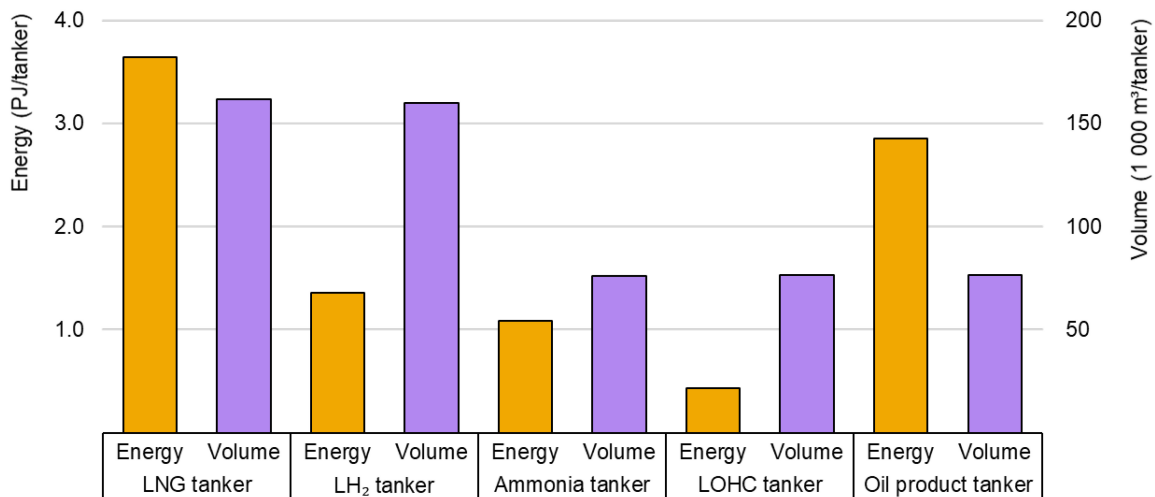

IEA. CC BY 4.0.

Notes: PJ/tanker = tanker capacity in petajoule; 1 000m³/tanker = tanker capacity in thousand cubic metres; LH₂ = liquefied hydrogen; LNG = liquefied natural gas; LOHC = liquid organic hydrogen carrier; m³ = cubic metre. LNG tanker size corresponds to the average size of tankers built since 2000; LH₂ tanker size to the size expected by ship manufacturers. While current ammonia tankers are often smaller, it is assumed that ammonia will be transported by very large gas tankers to accommodate the expected increase in ammonia trade. LOHC tankers are supposed to carry methylcyclohexane, and oil product tankers to carry diesel. It is assumed that oil product tankers could carry LOHC tankers.

In 2030, LH₂ tankers are expected to be similar in volume to LNG tankers and ammonia tankers to be half as big, with both carrying one-third of the energy content per shipment.

LH₂ transport

Shipping hydrogen in the form of LH₂ may be especially attractive in places where end users require high-purity hydrogen. While hydrogen liquefaction and storage technologies have been used for decades, mostly in the space and petrochemical industries, they have never been deployed on the scale projected in the NZE Scenario. The world's first and only shipment of liquefied hydrogen from Australia to Japan took place in February 2022, as part of the Hydrogen Energy Supply Chain (HESC) demonstration project (HESC, 2022). At the commercial phase, the HESC project aims to produce 225 kilotonnes per year (ktpa) of LH₂. A number of other such projects have also been announced, for example in Australia at the ports of Gladstone and Townsville in Queensland, and at Kwinana in metropolitan Perth. The port of Sines (Portugal) is also studying the feasibility of LH₂ trade. Announced projects could boost global output to 0.6 Mt by 2030 if they all materialise (IEA, 2022b).

Hydrogen liquefaction is a reasonably well-established technology with a total global capacity of around 500 tonnes per day (tpd) at the end of 2021 (IEA, 2022b). However, improvements are required for it to be deployed on a larger scale, as well as to lower costs and improve efficiency. The most recent plants consume approximately 10 kilowatt-hours of electricity per kg of H₂ (kWh/kg H₂) – equivalent to around 30% of the energy content of the hydrogen produced (based on lower heating value). The size of the plants in operation or under construction is still below 100 tpd. However, large LH₂ plants are planned at the future export port terminals mentioned above, with capacities in the 100-800 tpd range. Improvements are expected to raise efficiency in larger plants to 6-8 kWh/kg H₂ by 2030 in the NZE Scenario.⁵²

Due to hydrogen's low boiling point compared with natural gas (-253°C compared with -162°C for natural gas), special thermal insulation is needed to minimise high boil-off rates during storage.⁵³ Large-scale LH₂ storage technology in use today has changed little since the 1960s, with tanks often featuring double-shell vacuum insulation. Innovation is needed to enlarge tanks from their current volume of less than 5 000 cubic metre (m³) to sizes similar to those used for LNG, which typically range from 40 000 to 200 000 m³.

⁵² The Strategic Research and Innovation Agenda (SRIA) 2021-2027 of the European Union Clean Hydrogen Joint Undertaking has an energy intensity target of 6-8 kWh/kg H₂ by 2030 (Clean Hydrogen Joint Undertaking, 2022), while the US Department of Energy (DOE) Technical Targets for Hydrogen Delivery have an ultimate goal of 6 kWh/kg H₂.

⁵³ Despite tank insulation, small amounts of heat will cause gas evaporation, known as boil-off, which must be removed to avoid an increase in pressure.

Table 5.3 Announced designs for liquefied hydrogen tankers expected to be commercial before 2030

Company	H ₂ cargo containment	Country	Approval in principle*	Volume (m ³)
Korea Shipbuilding & Offshore Engineering (KSOE), Hyundai Mipo Dockyard	Spherical	Korea	Korean Register of Shipping (KRS)	20 000
Samsung Heavy Industries	Type C	Korea	American Bureau of Shipping (ABS)	20 000
C-Job Naval Architects, LH2 Europe	Spherical	Netherlands	-	37 500
Kawasaki Heavy Industries (KHI)	Spherical	Japan	Nippon Kaiji Kyokai (ClassNK)	160 000
Samsung Heavy Industries	Membrane	Korea	Lloyd's Register	160 000
GTT	Membrane	France	DNV	-

* An approval in principle is an independent assessment of conceptual and innovative shipbuilding within an agreed framework, confirming that the ship design is feasible and that no significant obstacles exist to prevent the concept from being realised.

Note: m³ = cubic metre.

Source: IEA analysis based on company announcements.

Shipping LH₂ is similar to LNG but, like for storage, boil-off rates during the voyage should be minimised, for instance by using double-shell vacuum insulation tanks or membrane-based insulation systems.⁵⁴ In addition, LH₂ ships aim to use hydrogen boil-off as fuel for the loaded leg of the journey, employing it as a low-emission shipping fuel while avoiding the need to vent it. The world's first LH₂ ship built for the HESC demonstration project – the Suiso Frontier, made by Kawasaki Heavy Industries – has a capacity of 1 250 m³ (75 tonnes of LH₂ per trip) and uses double-shell vacuum insulation tanks (HESC, 2022). Several other companies are working on design concepts with the aim of commercialising them by 2030, which is subsequently assumed in the NZE Scenario (Table 5.3).

LH₂ trade in the NZE Scenario is projected to take off much more rapidly than LNG trade did after the first ocean shipment in 1959. Since then, the size of the LNG tanker fleet has increased more than 50 times, from 5 000 m³ to more than 260 000 m³ for Q-max LNG tankers. LH₂ tanker designs will benefit from this experience. According to proposed KHI and Samsung Heavy Industry designs for tankers that could be in operation by 2030, their capacities will be 130 times greater on average than the first 1 250 m³ demonstration shipment of the Suiso

⁵⁴ Most large new LNG tankers are membrane-type ships with prismatic cargo tanks and double insulation systems, but many in the current operating fleet are Moss-type (named after the company that first designed it), characterised by spherical self-supporting cargo tanks (four or five depending on the size) that usually extend halfway above the deck.

Frontier tanker in 2022 (the storage tank is expected to be 32 times larger but there would be four storage tanks instead of one) (Figure 5.20).

Figure 5.20 Global LNG trade and largest LNG and LH₂ tanker sizes

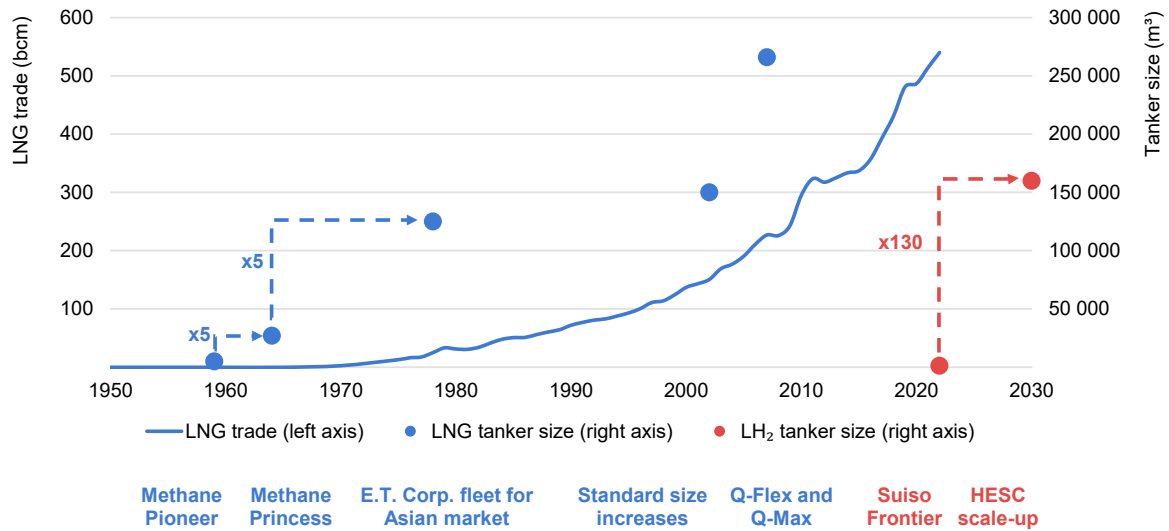

IEA. CC BY 4.0.

Notes: LNG = liquefied natural gas; LH₂ = liquefied hydrogen; m³ = cubic metre; bcm = billion cubic metres. Sources: IEA analysis based on Cedigaz (2018); ICIS (2022) and HESC (2022).

It took almost 50 years for LNG tankers to reach the size the hydrogen industry aims to achieve for LH₂ tankers by 2030, leveraging knowledge gained from LNG shipping.

Ammonia transport

About 70% of ammonia is currently used for fertiliser, including the downstream use of its derivatives, while the remainder is employed for various industrial applications such as plastics, explosives and synthetic fibres (IEA, 2021). In the NZE Scenario, ammonia is also used as a fuel in power plants and for shipping, and as a hydrogen carrier that can be cracked to deliver hydrogen.

Ammonia is currently produced using nitrogen sourced from the air and hydrogen, 70% of which is produced through steam methane reforming (SMR) of natural gas and the remaining 30% mainly from coal (mostly in China). Global ammonia trade amounts to around 20 Mt – equal to just over 10% of global ammonia supply of around 182 Mt in 2019 (IEA, 2021). Ammonia trade is small relative to output, as other ammonia derivatives, particularly urea, offer a more convenient way to transport nitrogen for fertiliser. Some countries also favour domestic production for reasons of industrial activity and fertiliser self-sufficiency. The main exporters have access to abundant natural gas reserves so can produce ammonia for export at relatively low cost. Large-scale infrastructure for ammonia storage and transport using mature technologies already exists with well-established international shipping routes (Figure 5.21).

According to planned export-oriented projects, an estimated 6 Mt of low-emission hydrogen traded as ammonia (equivalent to 34 Mt of ammonia) could come on line by 2030 – 10 Mt short of the NZE Scenario projection (equal to five times current global trade of fossil-based ammonia). A substantial expansion of existing port and shipping infrastructure would be needed to accommodate this increase. Trade continues to rise to 30 Mt of low-emission hydrogen (168 Mt of ammonia) by 2050, equal to almost ten times current trade.

Figure 5.21 International ammonia trade flows via shipping, 2019

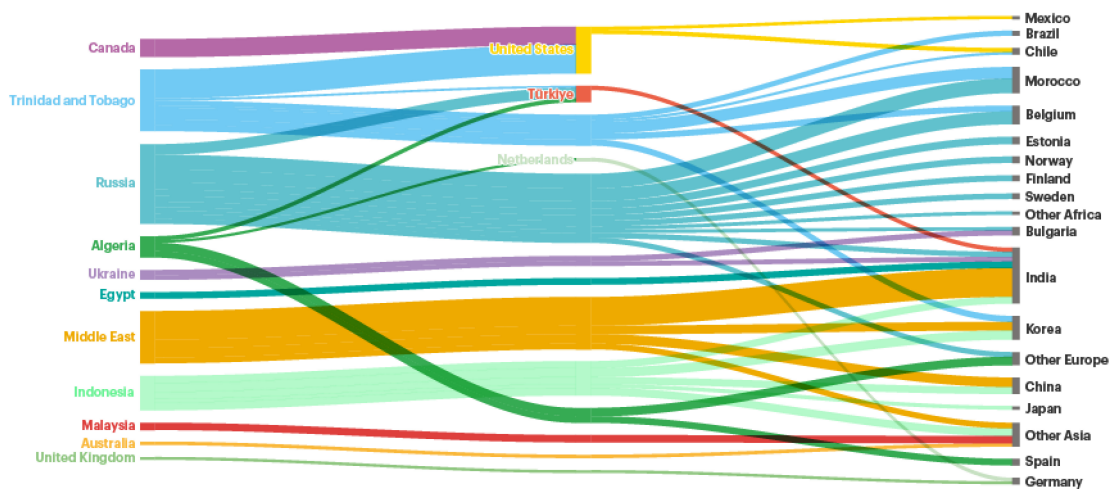

IEA. CC BY 4.0.

Notes: Only flows greater than 0.1 Mt are shown. Total ammonia shipping amounted to 20 Mt in 2019.

Source: IEA analysis based on CEPII (2022).

Differences in ammonia production costs drive trade, as countries with abundant natural gas reserves can produce ammonia for export at relatively low cost.

Over 120 ports worldwide can handle ammonia on a large scale. Expanding the capacity of terminals substantially, as required after 2030 in the NZE Scenario, would hinge on enlarging existing facilities and creating new ones, including to serve emerging trade routes for low-emission ammonia. Making space available in often congested ports may be tricky, as ammonia handling has to meet strict technical standards, including distance considerations for safety reasons. In addition, while some export projects may be able to make use of existing port infrastructure, ammonia derived from electrolytic hydrogen would come largely from areas with good renewable resources, where infrastructure for ammonia exports or even well-developed port infrastructure with deep water berths may not exist yet. Ammonia storage capacity at ports is often in the range of 15-60 kt, though some large import and export ports have capacities of more than 100 kt. Storage capacity at import and export terminals worldwide totals almost 5 Mt.

Assuming that import and export storage tanks are loaded and unloaded 15 times per year, the projected expansion of global ammonia trade in the NZE Scenario would require 12 Mt of storage in 2030 and 22 Mt in 2050.

Ammonia is shipped in fully refrigerated non-pressurised tankers often designed to carry liquefied petroleum gas (LPG) (as long as no parts containing copper or zinc or their alloys are in contact with the cargo). There are about 200 gas tankers in operation across the world capable of transporting ammonia, 40 of which are in exclusive use (DNV, 2022a). They range in size from 30 000 to 80 000 m³ (2055 kt of ammonia), with the latest orders having capacities of up to 87 000 m³ (MOL, 2021). The increase in trade envisioned in the NZE Scenario implies the need for very large gas tankers, often exceeding 80 000 m³, to ship ammonia. By 2030, more than 175 very large gas tankers would need to be dedicated year-round to low-emission ammonia shipping, increasing to almost 300 in 2050. Tanker manufacturing capacity may struggle to keep pace with these needs, given competing demand from other sectors (see Material Needs and Supply Chains below).

The amount of ammonia that can be directly consumed for emerging energy uses such as power generation or as a fuel for shipping depends on innovation. Low-emission hydrogen can also be temporarily converted into ammonia for long-distance trade, for which shipping and storage technologies are already mature (unlike for LH₂), and then reconverted back into hydrogen using ammonia crackers. Ammonia cracking is currently carried out at high temperatures and is therefore highly energy-intensive, consuming roughly 30% of the fuel's energy content. Ammonia cracking at lower temperatures (less than 450°C) is less energy-intensive but involves the use of catalysts made with expensive precious metals. The use of low-temperature ammonia cracking with no or limited use of such precious metals, which is not yet commercial, accelerates in the NZE Scenario after 2030. Recent progress made by companies such as Thyssenkrupp Uhde and Topsoe suggests this is achievable (IEA, 2022b).

Hydrogen transport costs

Lowering costs through technological advances is critical to raise prospects for hydrogen transport, particularly for cross-border trade. It is likely that, where feasible, onshore or offshore pipelines will be preferred: it is the most efficient and least costly way to transport hydrogen up to a distance of 2 000-2 500 km for capacities below 600 ktpa in 2030 in the NZE Scenario (Figure 5.22).

Large-diameter pipelines may be cheaper even over longer distances where feasible; however, hydrogen production and demand may be too small initially to justify investment in a large pipeline (with significant oversizing until production grows), or the construction of a pipeline across different jurisdictions may be impracticable. It is generally more affordable to site electrolytic hydrogen

production facilities next to a power generation source and transport the hydrogen to demand centres, rather than transmit electricity over long distances.

Figure 5.22 Indicative levelised cost of delivering hydrogen, by transport option and distance in the NZE Scenario, 2030

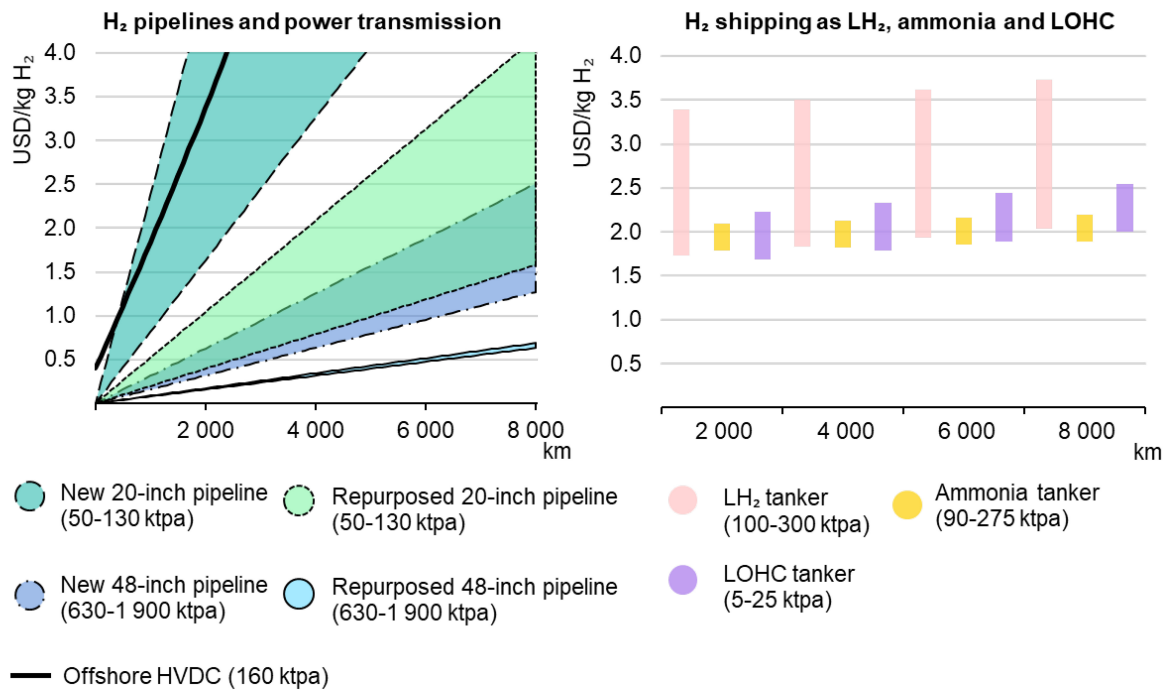

IEA. CC BY 4.0.

Notes: HVDC = high-voltage direct current; H₂ = hydrogen; ktpa = kilotonnes per year; LH₂ = liquefied hydrogen; LOHC = liquid organic hydrogen carrier (methylcyclohexane considered); USD/kg H₂ = USD per kilogramme of hydrogen. Hydrogen pipelines refer to onshore transmission pipelines operating at 25-75% of their design capacity for 5 000 full-load hours. Electricity transmission by offshore HVDC indicates electricity transmission required to obtain 1 kg H₂ in an electrolyser with 69% efficiency. Transport costs by ship include investment and operational costs to convert hydrogen to a higher-density carrier, store it, ship it and reconvert it to deliver gaseous hydrogen. Shipping capacity range corresponds to the annual capacity of a port terminal with 10 to 30 shipments per year.

Where feasible, pipelines are the cheapest hydrogen transport option up to a certain distance, while for longer distances shipping becomes more cost-effective.

In 2030, LH₂ tanker technology is expected to reach the early commercialisation phase, with transport costs of delivering hydrogen averaging USD 2.0-3.7/kg H₂ for an 8 000-km trip in the NZE Scenario.⁵⁵ The cost of hydrogen shipping as LH₂ is driven by the cost for the LH₂ storage facilities at both the export and import ports (Figure 5.23). The costs of shipping ammonia and LOHC are expected to be lower, at USD 1.9-2.2/kg H₂ and USD 2.0-2.5/kg H₂ respectively. However, the energy needed to convert hydrogen into ammonia or LOHC and reconvert it back is the main cost component for these two shipping options.

⁵⁵ The levelised transport cost of delivering hydrogen includes investment and operational costs to convert hydrogen to a higher-density carrier, store it, ship it and reconvert it to deliver gaseous hydrogen.

Reducing energy consumption could considerably reduce hydrogen delivery costs, particularly since ammonia and LOHC reconversion requires energy at the import terminal, where energy would generally cost more than at the port of export. In contrast, hydrogen liquefaction benefits from lower energy costs at the export terminal.

Figure 5.23 Indicative levelised cost of delivering hydrogen, by shipping-option step and distance in the NZE Scenario, 2030

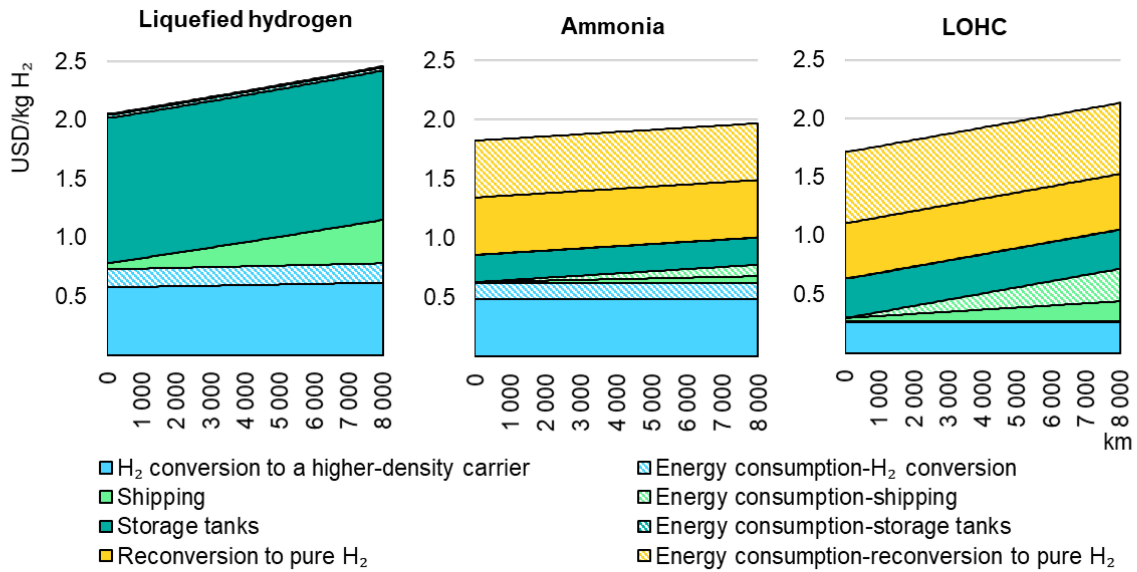

IEA. CC BY 4.0.

Notes: LOHC = liquid organic hydrogen carrier (methylcyclohexane considered); USD/kg H₂ = USD per kilogramme of hydrogen. The cost per stage includes all capital and operational expenditures except those related to energy, which are illustrated separately with a pattern fill. The discount rate is 5%. It is assumed that import and export terminals handle 20 shipments per year on average.

Storage tanks are the largest cost element in shipping hydrogen as LH₂, while the cost of energy for reconversion is the main expense for ammonia or an LOHC as hydrogen carrier.

Overall, the cost of shipping hydrogen as LH₂, ammonia or LOHC is USD 16-31/GJ by 2030 in the NZE Scenario. This is considerably more than the average cost range of liquefaction, shipping and regasification of natural gas, which is currently around USD 3-7/GJ. However, if hydrogen can be produced at low cost, despite high shipping costs, its cost could be lower than recent record-high international gas prices.⁵⁶

⁵⁶ In Q3 2022, the European TTF (Title Transfer Facility [the Netherlands]) natural gas price averaged USD 55/MBtu (USD 52/GJ), and the Asian spot price for LNG averaged USD 45/MBtu (USD 43/GJ) (IEA, 2022d).

Bulk hydrogen storage

Four types of underground geologic storage in operation today for natural gas could also be used to store hydrogen: salt caverns, depleted reservoirs (oil and gas fields),⁵⁷ saline aquifers and lined hard-rock caverns (IEA, 2022e). Each type has its own physical characteristics, affecting the type of service provided (Table 5.4).

Table 5.4 Characteristics of types of underground geological storage for hydrogen

	Salt cavern	Depleted gas field	Saline aquifer	Lined hard-rock cavern
Specific investment	Medium	Low	Low	High
Levelised cost of storage	Low	Medium	Medium	Medium
Cushion gas*	25-35%	45-60%	50-70%	10-20%
Capacity	Medium	Large	Large	Small
Annual cycles	Multiple	Few	Few	Multiple
Geographic availability	Limited	Variable	Variable	Abundant

* The volume of gas required as permanent inventory in a storage facility to maintain sufficient pressure to meet withdrawal demands at a high rate, even at low storage levels.

Depleted reservoirs and saline aquifers are relatively abundant and account for around 90% of existing global gas storage capacity (IGU, 2022). However, due to their porous nature, they have limited flexibility and can operate with only a few cycles per year. They play a very important role in meeting seasonal fluctuations in gas demand and enhancing security of supply today. Salt caverns are more flexible, with several cycles per year, but their geographical availability is limited and they typically have less working storage capacity. Lined hard-rock caverns can undergo several injection and withdrawal cycles per year, making them well suited to peaking purposes, but they are costly to build. Fast-cycling salt caverns and lined hard-rock caverns are more suitable to meet short-term supply fluctuations, which would be particularly useful for electrolytic hydrogen, while depleted gas fields and saline aquifers could be used to store large amounts of hydrogen between seasons and provide supply security.

The rapid growth in hydrogen supply envisioned in the NZE Scenario calls for a corresponding increase in bulk storage in underground facilities, in addition to storage tanks at port terminals, hydrogen plants, industrial sites of end users and refuelling stations. Global bulk storage capacity would need to rise from 0.5 TWh

⁵⁷ The term “depleted gas field” refers to hydrogen storage in depleted reservoirs, as it dominates project announcements.

at present to 90 TWh, or 30 billion cubic metres (bcm), in 2030 and 1 300 TWh (450 bcm⁵⁸) in 2050, assuming capacity equal to 10% of annual production, including imports (Figure 5.24).

Figure 5.24 Global underground geological storage capacity for hydrogen in the NZE Scenario and historical growth in natural gas storage by region

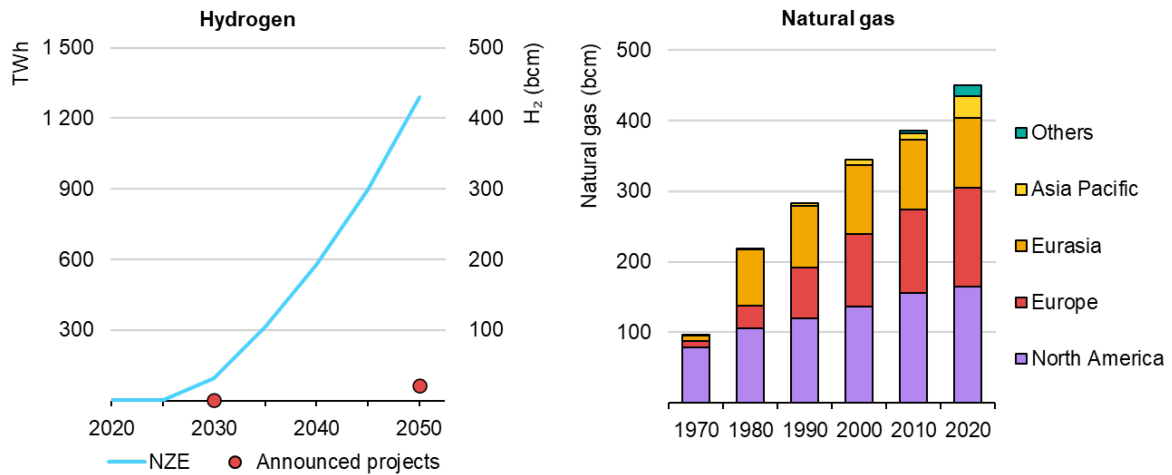

IEA. CC BY 4.0.

Notes: bcm = billion cubic metres (under normal conditions); TWh = terawatt-hour. The NZE Scenario assumes that storage capacity equals 3% of total annual hydrogen demand in 2030 and 10% in 2050. “Announced projects” are projects that are not yet operational, including those under construction, with a final investment decision, under feasibility assessment or projects that have been publicly announced, e.g. through a press release or a memorandum of understanding.

Sources: IEA analysis based on data from Rystad Energy (2022) and GIE (2021).

Rapid hydrogen supply growth in the NZE Scenario will require an increase in bulk underground storage, equal to more than twice that of natural gas over the last 30 years.

Because of hydrogen’s much lower volumetric density, storage volume in 2050 is close to that of natural gas today, requiring an increase in volume of more than twice that of natural gas during the last 30 years.

Several salt cavern hydrogen storage projects are in development, either adjacent to or involving repurposing of existing natural gas storage caverns. Both options benefit from expedited permitting processes, access to existing infrastructure and easier siting approvals than for greenfield developments. There are also several projects being planned involving repurposing depleted gas fields and aquifers currently used for storing natural gas. More research is needed to evaluate the effects of residual natural gas in depleted fields, in-situ bacteria reactions in saline aquifers and depleted gas fields that may contaminate the hydrogen or cause losses, and the risk of leakage due to the smaller size of the hydrogen molecule compared with methane (natural gas). At present, the combined capacity of

⁵⁸ Under normal conditions

planned salt cavern storage projects for hydrogen to be available by 2030 amounts to around 3.2 TWh, equal to a mere 0.1% of total merchant hydrogen demand in the NZE Scenario. Underground storage will play an important role in providing flexibility to the energy system, particularly where variable renewable energy sources dominate the power generation mix, enhancing security of supply. However, current research, development and demonstration activity remains worryingly weak, especially since the lead time from planning to commissioning such facilities can be more than a decade.

While hydrogen may compete with natural gas for access to suitable geological formations for bulk storage, it is unlikely to compete with CO₂, for which salt caverns and lined hard-rock caverns are unsuitable. Compared with hydrogen storage, significantly more CO₂ storage is required in the NZE Scenario. Today, there are more than 700 underground natural gas storage facilities in operation with a storage capacity of around 450 bcm, similar to the volume of hydrogen storage required in 2050. By comparison, around 86 500 Gt of CO₂ (around 48 000 bcm⁵⁹) will have been cumulatively stored in thousands of CO₂ storage sites around the world and some 3 250 bcm of CO₂ will be injected for permanent storage in 2050 in the NZE Scenario. Unlike hydrogen and natural gas, CO₂ storage is not cyclical, so storage capacity needs to continue to grow over time. CO₂ storage in depleted oil or gas fields and in saline aquifers is a more mature technology with fewer technical constraints, and alternative storage options are more limited than for hydrogen. This suggests that the majority of these resources would probably be developed to store CO₂ rather than hydrogen. Regions and countries should therefore consider both their CO₂ and hydrogen storage needs when devising resource development strategies and plans.

Hydrogen refuelling stations

To serve the fuel cell electric vehicle (FCEV) market, hydrogen refuelling stations (HRs) are essential. Over 4 600 HRs would need to be installed by 2030 in the NZE Scenario to support the growing fleet of heavy-duty fuel cell trucks, assuming an average nameplate capacity of over 2.5 tonnes per day.⁶⁰ At the end of 2021, about 730 HRs were dispensing fuel at 350 and/or 700 bars to 880 heavy-duty trucks, 3 600 medium-duty trucks, 4 700 buses and around 42 000 cars.

Careful planning is needed to avoid bottlenecks and delays in scaling up refuelling infrastructure in line with the NZE Scenario. The time needed for permitting, design approvals, construction and inspection of completed stations is generally short. In

⁵⁹ CO₂ is conventionally presented as the amount of mass injected: here, the number of bcm at 15°C and 0.98 bars allows for comparison with hydrogen.

⁶⁰ The total number of HRs in 2030 in the NZE Scenario would need to be even higher to support fuel cell cars, vans, buses and medium-duty trucks.

California, the median time to open a new station has been around 2.5 years in the recent past. Manufacturing of station components, of both current technologies not yet designed for high-throughput refuelling and innovative components for higher flow rates, would need to ramp up quickly. Major station components include storage tanks, compressors, heat exchangers, nozzles, hoses, breakaways and receptacles, and fuel dispensers. For heavy-duty truck HRSs with a capacity of over 1 tonne per day, hydrogen will likely be delivered as LH₂ either by tanker or pipeline, since large numbers of gaseous tube trailer deliveries can complicate operations. Standardised components do not exist for liquid hydrogen dispensing, so this is not likely to play a significant role this decade.

Innovative technology is being developed to enable fast refuelling of fuel cell trucks with 700-bar onboard hydrogen storage, to allow for fuelling times and driving ranges comparable to diesel trucks. The US DOE has set a target flow rate of 10 kg per minute for trucks with onboard storage capacity of 60 kg, which would boost driving range to about 1 200 km and cut refuelling time to just 6 minutes (Marcinkoski et al., 2019). Refuelling protocols currently limit flow rates for safety reasons, meaning that refuelling can take 30 minutes or longer for a 40-kg tank. The industry is seeking to change those protocols to allow for high-throughput 700-bar refuelling, which would require new safety standards for HRSs by the International Standards Organisation (ISO). Both will probably take another three to four years to be finalised.

The US National Renewable Energy Laboratory (NREL) has developed simulation models and a test station to encourage the development of technologies, protocols and standards. In April 2022, NREL demonstrated flow rates of 14 kg/minute. As a next important step, NREL plans to test new station components, such as nozzles and hoses, that have been adapted to the higher targeted flow rates. In addition, flow control strategies, including valves that control flow rates, may need to be reassessed. Commercialisation of these new station components is expected to take two to three years.

Fuel providers have already begun building stations with higher capacities to serve heavy-duty fuel cell trucks and buses. For example, as part of the HyAMMED/H2Haul project, Air Liquide has built a 1-tonne-per-day station in southern France to serve eight trucks and other FCEVs (Air Liquide, 2020). The station was designed to allow for upgrading to high-throughput refuelling once the necessary components have been tested and qualified. For a project with the Port of Los Angeles, two HRSs with capacity of 1.5 tonnes per day have been built. In addition, three HRSs are planned for the R-HySE project in France, each with a capacity of 2 tonnes per day, to support 50 fuel cell trucks by 2025.

Because current stations are not technically capable of providing high-throughput refuelling through a single nozzle, some fuel cell trucks have been designed for multiple fuelling points so that more than one nozzle can be used concurrently to reduce refuelling time with current infrastructure. Others, however, have maintained designs with single fuelling points and instead are working to advance protocol and technology developments.

Material needs and supply chains

Hydrogen pipelines

Steel pipeline manufacturing is a well-established industry. Global production of steel tubular products is estimated at 130 Mt, with pipelines (primarily used in oil and gas applications) accounting for 28 Mt, or 21% of the total (Trupply, 2022). This compares with 1 900 Mt of crude steel produced annually today. In the NZE Scenario, the falling need for oil and gas pipelines as the global energy system is decarbonised is partially offset by increased demand for hydrogen and CO₂ pipelines.

The steel required for new hydrogen pipelines worldwide amounts to 1.1 Mt in 2030 and 3.5 Mt in 2050 in the NZE Scenario – a relatively small fraction of current steel pipe production capacity. Although pipelines with smaller diameters need less steel, their carrying capacity is proportionately much less, increasing steel intensity per unit of hydrogen transported. For instance, a 20-inch pipeline (X70 steel) uses around 30% of the steel of a 48-inch pipeline, but the capacity is more than ten times smaller, so steel intensity is almost four times higher, raising investment and operating costs as well as the environmental impact of steel production. Similarly, the use of high-strength steels allows for thinner walls, cutting steel consumption by 25%, for example, when X70 steel is used instead of X52 for a 48-inch hydrogen pipeline (80 bars), though it is more expensive. However, as less is known about their operational performance, concerns about safety could lead to very conservative designs, offsetting these material gains (Golisch et al., 2022). In the long term, better understanding of the behaviour of hydrogen pipelines will probably lead to less steel-intensive pipelines. In addition, lighter composite pipelines with no embrittlement risk may also be used for hydrogen transport, particularly for offshore hydrogen-production gathering lines (Strohm, 2022).

When possible, repurposing existing pipelines to transport hydrogen or CO₂ could reduce steel consumption, pipeline costs and the environmental impact of material manufacturing and construction. Repurposing also has the potential to dramatically reduce lead times. Current pipe manufacturing capacity seems to be sufficient to meet projected demand for hydrogen and CO₂ pipelines through to 2050 in the NZE Scenario. But while there are plenty of producers of tubular steel

products in the global market, the number of laboratories capable of doing the in-situ gaseous hydrogen testing often required for certification is limited,⁶¹ which might cause bottlenecks (Martin et al., 2022).

Liquefied gas tankers

As with pipelines, the main material used to build a hydrogen or ammonia tanker is steel, which is needed to make the hull, onboard equipment and tank structures. Building the 200 ships needed to transport LH₂ and the 300 ships to transport ammonia in 2050 in the NZE Scenario would require a little over 7 Mt of steel, assuming that ammonia ships are comparable in size to very large gas carriers (60 000-80 000 m³) and that the ones used for LH₂ are closer to LNG tankers.⁶² This is equivalent to the United Kingdom's current steel production, or about 0.01% of projected global cumulative crude steel demand by 2050 in the NZE Scenario. However, although the amount of steel used is relatively small, liquefied gas tankers require specific steel types able to withstand very low temperatures in areas in contact or with a risk of being in contact with the cargo. In addition, the steel used in shipbuilding has to be very durable to cope with rough seas. Carbon manganese steel can be used in parts of LPG tankers that are in contact with or next to the cargo, suitable for temperatures as low as -55°C, while the more expensive 9% Ni steel is commonly used in LNG tankers, withstanding temperatures of -165°C. In areas not at risk of being in contact with the cargo, steels that offer high strength with limited thickness (to decrease weight) are used. Global production of the cryogenic alloys used is small, and shipyards have agreements with steel manufacturers that supply them the specific type of steel needed.

More than 170 dedicated year-round ammonia tankers and 20 LH₂ tankers need to be built by 2030 in the NZE Scenario, equal to around 40% of total liquefied gas tanker deliveries over the last five years. This could conflict with demand for other types of liquefied gas tankers and for vessels in general, considering that liquefied gas tankers accounted for 9% of all ships built in 2020 in terms of gross cargo capacity (UNCTAD, 2021). Therefore, while shipbuilding capacities are unlikely to constrain the ability to supply these ships in the longer term (towards 2050), competing demands for ships could cause delays in the near and medium term, particularly during this decade (Figure 5.25).

⁶¹ Rosen and Salzgitter Mannesmann Forschung in Germany, Corinth Pipeworks in Greece, RINA in Italy and DNV in the United States have facilities for hydrogen testing in compliance with the requirements of the ASME B31.12 standards. Most of them opened in just the last few years.

⁶² For current Panamax type ships with an average capacity of about 70 000 m³, the weight of the steel is more than 11 000 tonnes. Large LNG tankers usually have a capacity of 140 000-180 000 m³ and need about 20 000 tonnes.

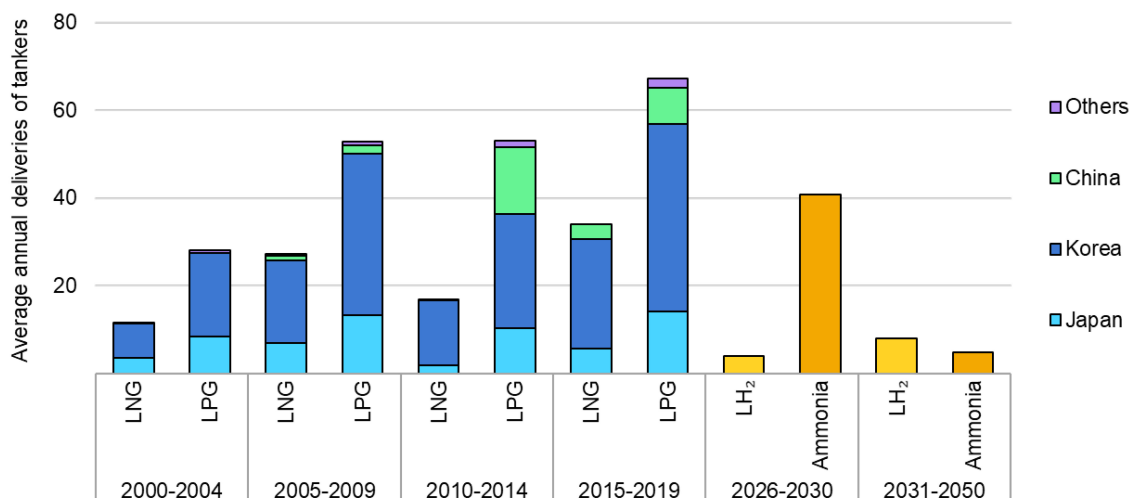
Figure 5.25 Global liquefied gas tanker deliveries by country and type in the NZE Scenario

IEA. CC BY 4.0.

Notes: LH₂ = liquefied hydrogen; LNG = liquefied natural gas; LPG = liquefied petroleum gas. For the LNG tanker count, small and medium-sized tankers, icebreakers and bunkering vessels are not included. Ammonia is often shipped in tankers designed to carry LPG, as it has a lower boiling point than ammonia, so LPG tankers are used as a reference for tankers that could carry ammonia.

Sources: IEA analysis based on VesselFinder (2022) and UNCTAD (2021).

More than 170 dedicated ammonia tankers and 20 LH₂ tankers need to be built by 2030 in the NZE Scenario, equal to around 40% of total gas tanker deliveries over the last 5 years.

Making liquefied gas tankers is more complex than building most other types of ship, limiting opportunities for new entrants. It requires considerable co-ordination, as workers need to assemble thousands of different components, which must be manufactured correctly and arrive in time. This is reflected in the higher price and longer construction times of these vessels (Brun, 2017). Incumbent shipbuilders may be best placed to develop technologies for future gas tankers, including new propulsion systems, and also to build them, given the complexity of the supply chains and the tight schedules.

Korea, China and Japan dominate the market for liquefied gas tankers. In 2020, China overtook Japan as the second-largest producer of such tankers, which have historically been supplied mainly by Korean and Japanese shipbuilders (UNCTAD, 2021). Before the Covid-19 pandemic, the shipbuilding sector had already been facing fierce competition and was in the process of restructuring, in some cases with government financial assistance, leading to some consolidation in the sector in China and Korea (UNCTAD, 2020). In Korea, Hyundai Heavy Industries (the world's largest shipbuilder) tried to acquire Daewoo Shipbuilding and Marine Engineering, which would have given it control of at least 60% of the market for LNG tankers (European Commission, 2022b). But in 2022, the European Union prohibited the proposed merger on the grounds that it would reduce global LNG tanker market competition, potentially restricting supplies and raising prices, and

ultimately increasing the cost of energy for European consumers. Some Japanese companies have moved into other, more profitable businesses, and others have gone bankrupt.

While shipbuilding capacity is concentrated in the Asia-Pacific region, where most producers are largely self-sufficient for material inputs, hydrogen equipment is also manufactured by companies headquartered and with factories elsewhere, notably in Europe and North America. For example, GTT and ICT, which manufacture tank membrane systems compatible with ammonia and hydrogen respectively, are both based in Europe. According to GTT's order book, 137 of the 161 membrane systems it is to deliver by 2025, mainly to shipbuilders in Asia, will equip LNG tankers with capacities generally greater than 170 000 m³ (GTT, 2022).

Compressors for hydrogen transmission and storage

Without major facility or workforce adaptations, companies already active in this sector are able to manufacture compressors (including new high-speed centrifugal compressors) for new hydrogen pipelines and for injecting the gas into underground storage facilities (Table 5.5).

Table 5.5 Selected companies commercialising or planning to commercialise compressors suitable for hydrogen transmission and storage

Company	Country	Compressor type
Atlas Copco	Sweden	Centrifugal compressors
Baker Hughes	United States	Hydrogen-ready turbo-compression centrifugal compressors
Burckhardt Compression	Switzerland	Reciprocating compressors
Denair	China	Reciprocating compressors
Siemens	Germany	Centrifugal compressors
Kawasaki Heavy Industry	Japan	Centrifugal compressors
MAN Energy Solutions	Germany	Hydrogen compression for pipelines
Mitsubishi Heavy Industries	Japan	Working on improving high-speed centrifugal compressors for hydrogen (ready in 2023-2024)
Neuman & Esser	Germany	Reciprocating compressors
SIAD Macchine Impianti	Italy	Reciprocating compressors

The materials needed to manufacture them are easily obtained and unlikely to be affected by major bottlenecks. For capacities of up to 2 GW, current state-of-the-art piston compressors are the most economical solution, with several companies manufacturing them around the world. Larger capacities require centrifugal compressors (which use turbo motors) to improve efficiency. The technology is not yet commercially available, but it is expected to become so in the next few years if sufficient demand materialises.

Potential lead times for hydrogen infrastructure

Lead times to build new hydrogen infrastructure are likely to vary from country to country and project to project due to differences in several factors, notably regulations, permitting rules, public acceptance and conformity with standards, common to most energy infrastructure projects (Box 5.1, above). Natural gas infrastructure lead times are a good indication of how long it will take to complete hydrogen projects due to similarities in project types and in manufacturing/construction processes (Figure 5.26). In general, the larger the project and the greater the environmental impact, the longer planning and construction take. Gas infrastructure projects typically have long lead times; similar lead times for hydrogen projects could pose a major threat to the timely expansion of infrastructure needed to achieve net zero emissions by mid-century.

Planning and permitting of most recent natural gas pipelines took two to eight years, but some of these projects had been discussed for decades before a feasibility study was initiated. Construction usually lasts around three years for both onshore and offshore projects, but some pipelines were completed in less than two years, such as the onshore 440-km North European Natural Gas Pipeline in Germany commissioned in 2013 and the offshore 275-km Baltic Pipe between Poland and Denmark commissioned in 2022 (Baltic Pipe Project, 2022).

LNG terminals provide an indication of potential lead times for LH₂ export and import terminals. They usually take three to five years to build, while the entire planning and construction process, including the preparation of feasibility studies, can take up to 12 years. The construction period for an onshore LNG terminal is determined by the amount of time needed to install the storage tanks, which usually takes about 30 months for engineering and construction. This sets the schedule for the entire project, including the procurement of other components. The other element that is most time-consuming is construction of the jetty, though in some cases jetty-less floating technology can be used, enabling gas transfer between the tanker and an offshore or onshore terminal without a jetty.

Floating terminals can be delivered in half the time of an onshore terminal. Construction of onshore infrastructure rather than development of the unit itself typically determines the lead time. Converting an LNG vessel to a floating storage and regasification unit (FSRU) can take one to two years, while the construction time for a new one is about two to three years. Moving existing FSRUs from one place to another can also be carried out quickly. The same yard availability considerations as for ships applies to new FSRUs. Permitting, approval and local opposition can delay projects substantially. In response to the Russian invasion of Ukraine, some recently planned FSRU projects in Europe are moving ahead in less than a year and new regulations are being enacted to reduce lead times, such as the German LNG Acceleration Act passed in May 2022 (Germany, BMWK, 2022).

Figure 5.26 Lead times of selected natural gas infrastructure projects

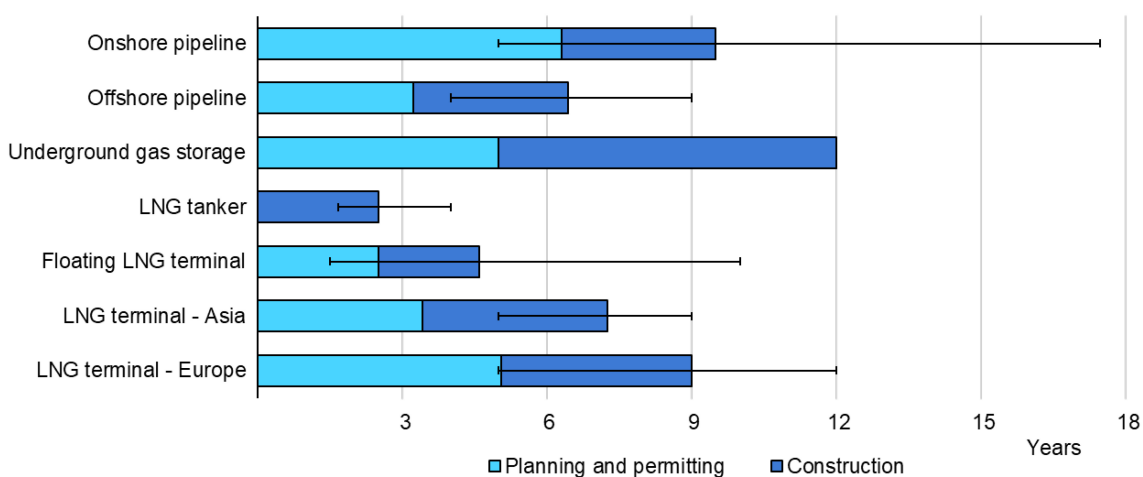

IEA. CC BY 4.0.

Notes: LNG = liquefied natural gas. Average lead times are presented for underground gas storage, LNG terminals, floating LNG terminals, gas tankers, and onshore and offshore pipelines. Bars represent average lead times and lines depict typical ranges based on selected recent projects.

Developing new gas infrastructure takes considerable time, so planning must start well in advance and strategies to shorten lead times should be explored.

The construction of very large gas tankers (often called very large gas carriers) for transporting LPG, which serves as a proxy for ammonia, usually takes about a year and a tanker for transporting LNG, which could serve as a proxy for an LH₂ tanker, takes two to four years. However, actual lead times can be longer because construction may not begin as soon as the order is placed if capacity at the shipbuilding yard is unavailable. A long order book, including demand for other ship types such as container ships, may delay the construction and completion of liquefied gas tankers: for example, several LNG tankers ordered in 2022 are not expected to be delivered before 2026 (DART, 2022; The Maritime Executive, 2022). Total yard capacity has remained constant since 2019, but the number of

active ones has decreased by 16% to 283 at present (Danish Ship Finance, 2022). Only 26 yards are now building LNG and LPG tankers, and order books are fairly full in many yards, with no capacity available for new LNG orders until 2027 (Bangkok Post, 2022).

Developing underground storage facilities for hydrogen is likely to involve considerable lead times unless they are based on existing natural gas facilities. Underground natural gas storage projects have lead times of five to ten years for salt caverns and depleted reservoirs, and 10-12 years for aquifer storage (IEA, 2022b). For hydrogen storage projects, which would undoubtedly make use of salt caverns, even larger time lags can be expected at the beginning, as practical experience with such facilities is very limited. While permitting would probably be much quicker to repurpose existing natural gas storage facilities, the flushing time for a salt cavern – the time it takes to flush out the rock salt deposit by injecting water to create space for the gas – is generally two to five years (Neuman & Esser Group, 2022). The HyStock project in the Netherlands estimates that permitting and construction could take about seven years in total, not including the planning phase (Hystock, 2022).

Energy needs and emissions

The energy consumed in transporting low-emission hydrogen worldwide to deliver hydrogen and ammonia⁶³ is projected to rise from almost zero at present to around 700 PJ in 2030 (equivalent to 0.2% of total final energy demand), and to more than 2 000 PJ in 2050 (0.6%) in the NZE Scenario (Figure 5.27). Expressed as a share of the energy content of the hydrogen transported, energy consumption for transportation amounts to 7% in 2030 and 5% in 2050.

Although only 16% of merchant hydrogen is shipped as LH₂ or ammonia in 2050 in the NZE Scenario, shipping accounts for more than three-quarters of all the energy required to move hydrogen from where it is generated to centres of demand, including through interregional trade and intraregional hydrogen transmission via pipeline. This is because shipping hydrogen, regardless of the distance, requires 8-17 kWh/kg H₂ of energy to convert the hydrogen to a form with a higher energy density (in volume terms) and/or reconvert it back to hydrogen when a carrier is used, i.e. the maximum overall efficiency would be 66-81%.⁶⁴ Hydrogen transport by pipeline does not have such an energy penalty, as energy consumption increases proportionally with distance. Hydrogen transport through a 48-inch pipeline over a distance of 8 000 km (operating at least at 75%

⁶³ Energy consumed to transport low-emission hydrogen as a synthetic fuel is not included in this section.

⁶⁴ Overall hydrogen transport efficiency is the ratio of net energy provided by the delivered hydrogen divided by that quantity and the total energy consumed during compression or conversion of the hydrogen into a higher-density carrier, and its storage, transport and reversion into hydrogen gas (when required).

of its design capacity) requires 4-7 kWh/kg H₂ of energy for compression, which would result in maximum overall efficiency of 82-89%. The construction and operation of a pipeline to transport hydrogen over 1 000 km involves energy consumption equal to 0.5-3.5% of the energy content of the hydrogen that will be transported during the pipeline's lifetime.

Figure 5.27 Global energy consumption for hydrogen transportation in the NZE Scenario

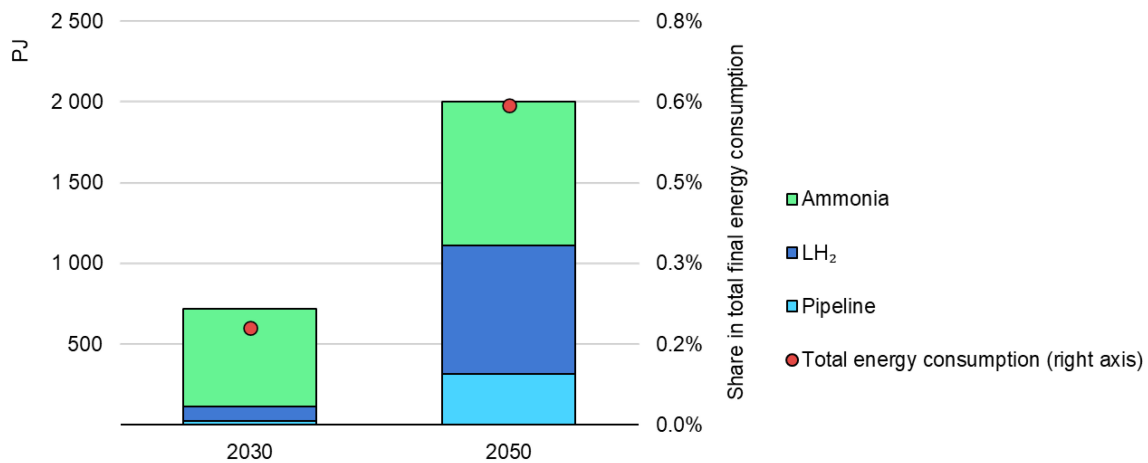

IEA. CC BY 4.0.

Notes: PJ = petajoule. LH₂ = liquefied hydrogen. Pipeline transportation of hydrogen covers interregional trade and intraregional transmission.

Global energy use for transporting hydrogen rises from almost zero today to the equivalent of 0.2% of total final energy demand in 2030 and 0.6% in 2050 in the NZE Scenario.

The shipping of hydrogen requires significant energy when energy for conversion and reconversion is accounted for (Figure 5.28). Improving the energy efficiency of hydrogen shipping will therefore need to remain a priority, not only to bring costs down but to minimise the environmental impacts, building on efforts for liquefied gas shipping today (Box 5.2). The EU SRIA aims to achieve overall efficiency of around 74% (12 kWh consumed/kg H₂ delivered) by 2030 for hydrogen shipping (Clean Hydrogen Joint Undertaking, 2022).

Figure 5.28 Energy consumption and overall efficiency of hydrogen transport and distance in the NZE Scenario, 2030

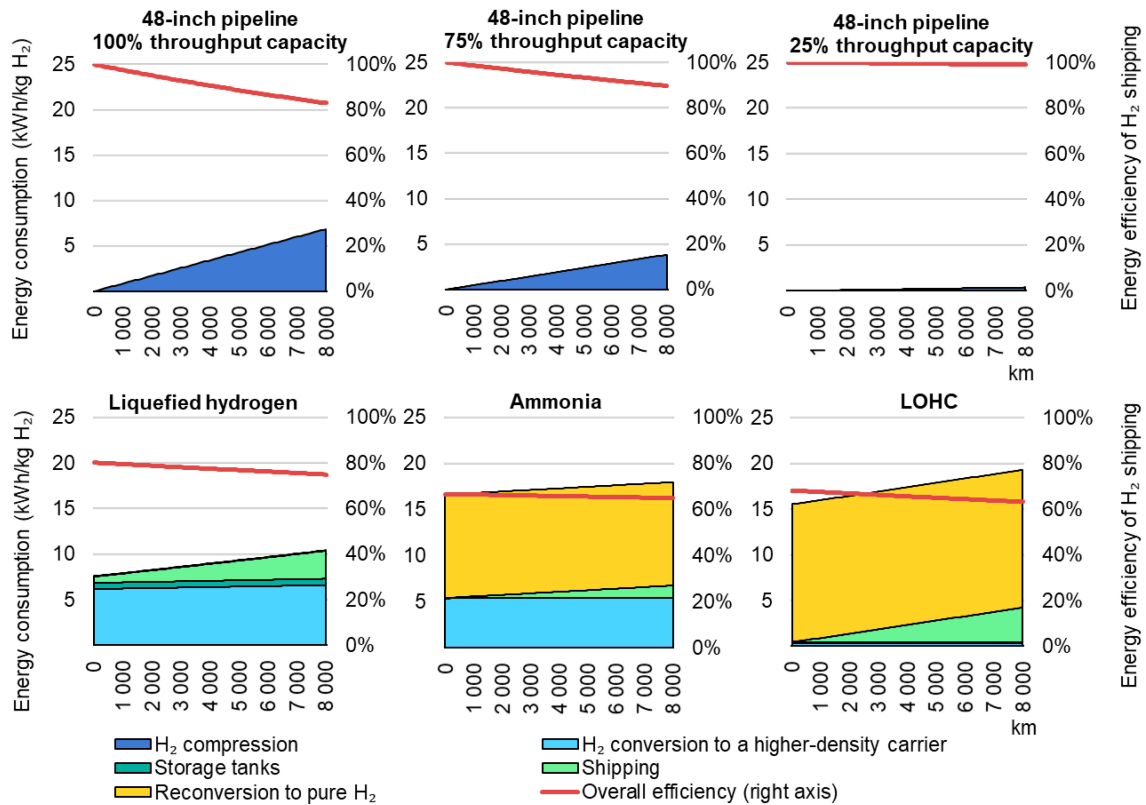

IEA. CC BY 4.0.

Notes: kWh/kg H₂ = kilowatt-hour per kilogramme of hydrogen. H₂ = hydrogen. LOHC = liquefied organic hydrogen carrier. 100% throughput capacity means that the pipeline is operated at 100% of its theoretical maximum capacity. The energy consumption of an LH₂ tanker is assumed to be equivalent to the amount of hydrogen boil-off gas during the voyage, and the energy consumption of LH₂ import and export storage tanks is hydrogen boil-off gas and electricity. Overall efficiency of hydrogen transport refers to the energy consumed during the conversion of hydrogen to a higher-density carrier, its storage, shipment and reconversion to gaseous hydrogen. 1 kg of hydrogen contains 33.3 kWh.

Long-distance shipping of hydrogen is expected to have an overall efficiency of 60-80%, but there are major opportunities to reduce energy consumption and lower costs.

Hydrogen is an indirect greenhouse gas (GHG), as it interacts with other gases and chemical species in the atmosphere, affecting the concentration of methane, ozone and water vapour. Some estimates indicate that hydrogen could have a global warming potential (GWP) over a 100-year time horizon of 11 ± 5 kg CO₂.eq/kg H₂ (United Kingdom, BEIS, 2022), compared with 29.8 ± 11 kg CO₂.eq/kg H₂ for fossil methane. Given hydrogen’s small molecule size, high diffusivity and low viscosity, leakage is possible along the entire value chain, particularly during its transport and storage. However, information on how much hydrogen leaks from pipelines, compressors, loading/unloading operations and storage is still limited. Mitigating potential climate impacts will require further research to understand hydrogen’s GWP, the deployment of technologies and operational practices to minimise leaks, and the implementation of robust leak detection and repair mechanisms.

Box 5.2 Environmental impacts of liquefied gas shipping

The bulk of GHG emissions from liquefied gas shipping, excluding conversion and potential reconversion, come from fuel combustion during transport. However, as the shipping sector decarbonises, including by using some LH₂ or ammonia tanker cargo as fuel, direct emissions should fall, though in the case of ammonia combustion, measures will be needed to minimise N₂O and NO_x emissions. Fuel consumption by the main engine is influenced by the condition of the hull's surface, the load, the weather and the ship's speed. Liquefied gas transport was responsible for 7% of global GHG emissions from shipping (0.2% of total emissions) and 8% of fuel consumption in shipping in 2018 (0.2% of total final energy consumption) (IMO, 2020). Improving the energy efficiency of shipping methane, hydrogen, ammonia and CO₂ would be economically beneficial because fuel costs would be lower, and the environmental impacts would also be reduced.

Once a ship reaches the end of its useful lifetime, it is sold to a shipbreaking or demolition shipyard, where it is disassembled. An estimated 95% of the materials used in its construction can be recycled or reused (UNEP, n.d.), primarily steel, which makes up 75-85% of a ship's weight (Brun, 2017). Some steel plates and beams can be extracted and directly reused by the construction industry, or they can be re-rolled and reused (without melting, thereby using less energy). In 2021, demolition and scrapping of liquefied gas tankers took place in India, Bangladesh and Türkiye (UNCTAD, 2021). There are concerns about the safety and environmental effects of ship disposal, with many of them being broken up on beaches. Some conventions and regulations concerning shipbreaking have been issued, including the International Maritime Organization's 2009 Hong Kong Convention for the Safe and Environmentally Sound Recycling of Ships (though it has not been ratified by enough countries to enter into force) and the EU Ship Recycling Regulation, in force since 2019.

Sources: Brun (2017); IMO (2020); UNEP (n.d.); UNCTAD (2021).

CO₂ management infrastructure

Types of CO₂ transport and storage infrastructure

Infrastructure for CO₂ management includes CO₂ transport and storage facilities. Once captured, CO₂ can be used on site or transported, in most cases by pipeline or ship, either to a point of use or to a permanent underground storage site (Figure 5.29). For the purposes of this report, CO₂ shipping refers to vessel-based oceangoing transport, including ocean barges.

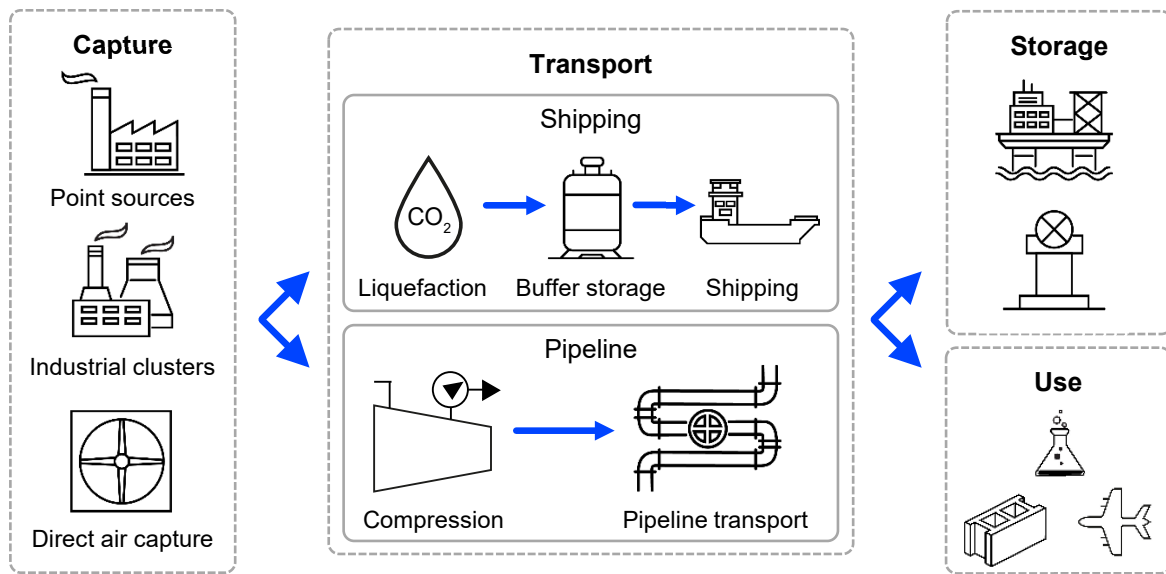
Figure 5.29 CO₂ flows through the CO₂ management value chain

IEA. CC BY 4.0.

Notes: CO₂ = carbon dioxide. Blue arrows indicate the flow of CO₂.

Once captured, CO₂ can be used on site or transported, in most cases by pipeline or ship, either to a point of use or to a permanent underground storage site.

CO₂ pipelines

Pipelines can be an efficient and cheap method to transport CO₂ over long distances. They offer substantial economies of scale, with transport costs decreasing logarithmically with volume. To capitalise on this benefit, pipelines are often oversized relative to near-term transport demand, but this can increase risk for developers and make financing more difficult. Today, there are around 9 500 km of pipelines of all sizes transporting CO₂. Around 90% of them are in the United States and were built to transport CO₂ from natural reservoirs and industrial sources to oilfields for CO₂-enhanced oil recovery (CO₂-EOR). A number of projects in Europe and the United States have recently been announced to build multi-user CO₂ pipelines to transport CO₂ to dedicated storage sites.

CO₂ must be compressed to pipeline specifications after capture. The ISO 27913/2016 standard provides requirements for CO₂ pipelines while DNV-RP-F104 is a recommended practice. Depending on distance, diameter and CO₂ phase, booster stations may be needed along the pipeline to maintain pressure. CO₂ can be transported through a pipeline in gaseous form (or phase) or as a liquid, or in its dense phase.⁶⁵ The phase determines the required pipeline specifications, including grade of steel, and how it is operated, including

⁶⁵ CO₂ is in its dense phase when it is above its critical pressure but below its critical temperature. When above both critical temperature and pressure it is a supercritical fluid. In both cases, CO₂ exhibits the properties of both a liquid and a gas.

temperature, pressure and compression. In general, carbon steel is the most cost-effective material for CO₂ pipeline transport, with the grade of steel varying from X60 to X120 (Onyebuchi et al., 2018). For short distances and small volumes, transporting CO₂ in gaseous form can be cost-effective (Knoope, Ramírez and Faaij, 2013), while transforming the gas into a denser phase, as a supercritical fluid or a sub-cooled liquid, is more economical for large volumes and long distances.

CO₂ pipeline networks are an integral component of the hub-and-cluster model of carbon capture, utilisation and storage (CCUS) projects, but their configuration must be optimised to be cost-effective (Figure 5.30). Network design is determined by the volumes and rates of inputs and outputs, along with distance and geographic considerations.

Figure 5.30 CO₂ pipeline network

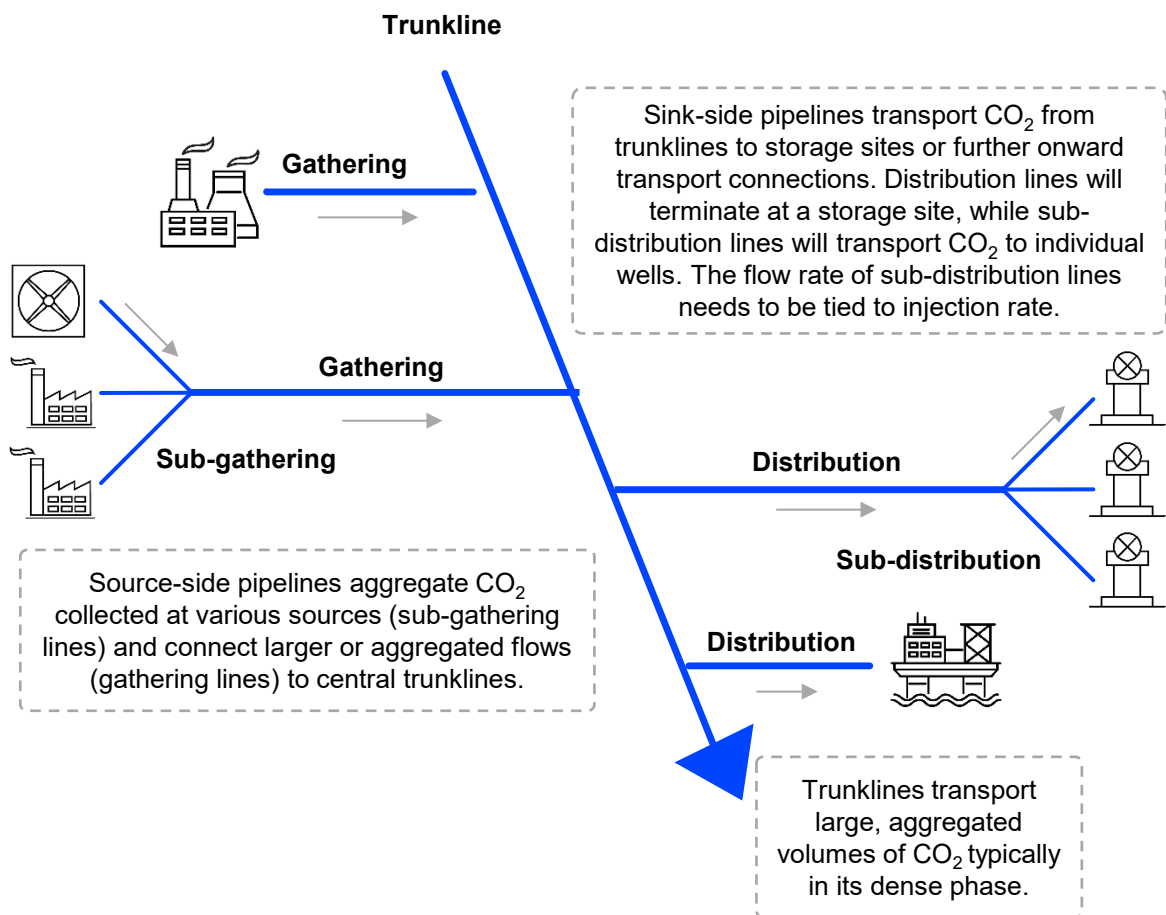

IEA. CC BY 4.0.

Note: CO₂ = carbon dioxide.

Source: Based on United States, DOE (2022c).

Efficient pipeline networks usually have a trunk-style transmission line with branches for gathering and distribution.

CO₂ shipping

Today, CO₂ shipping is limited to small-scale applications moving food-grade CO₂ from production sites to distribution terminals, where it is further distributed to end users. In recent years, several regions and countries, including Europe, Japan and Korea, have expressed interest in shipping large volumes of CO₂ to storage sites. CO₂ transport by ship has not yet been demonstrated at the scale required in the NZE Scenario. However, two medium-pressure CO₂ ships are under construction for the European Northern Lights Project – an open-source transportation and storage initiative aimed at storing CO₂ in depleted offshore fields in Norway – and other projects are pursuing shipping as a transport solution.

CO₂ shipping requires port infrastructure similar to that used for LNG and LPG, including facilities for CO₂ liquefaction, temporary storage and loading/unloading. These facilities need to expand in line with CO₂ shipments.

When shipping is the selected transport method, CO₂ needs to be liquefied first. Liquefaction involves a combination of cooling and compression of the CO₂. Liquefying CO₂ to -30°C to -55°C requires the use of cryogenic technology, which is more costly and energy-intensive than the compression required to move CO₂ by pipeline. Liquefaction processes can involve closed or open systems (Al Baroudi et al., 2021). Closed systems use an external refrigeration system, while open systems cool the CO₂ solely by compression and expansion, without the use of an external refrigerant. Open systems have a simpler design but are less efficient. During liquefaction, water needs to be removed from the CO₂ inlet stream by condensation and regenerative adsorption to prevent hydration, freezing and corrosion. Other contaminants (volatile components such as nitrogen and argon) must be removed as well to prevent dry-ice formation.

The flow of CO₂ from a source through liquefaction is typically continuous. Since shipping occurs in discrete runs and is a batch process, intermediate buffer storage is usually required to store the gas between ship journeys. Buffer storage can reduce ship loading time and enable fast loading. It also provides overflow storage in the case of delays. It typically comprises industrial CO₂ storage tanks but can also be in the form of a vessel, depending on the type of shipping. For example, the Dutch company Carbon Collectors is developing a transport solution in which barges are used to collect, move and then inject CO₂ into offshore storage sites (Carbon Collectors, n.d.). CO₂ loading can be performed using conventional articulated loading arms developed for other cryogenic liquids such as LPG and LNG. The liquid is transferred through an insulated pipeline, adapted to the chosen pressure and temperature, from the temporary storage or liquefaction facility to the loading arm and ship.

Other transport modes

Rail transport is currently used only for moving small volumes of CO₂. Specialised rail cars have been developed to transport CO₂ in cryogenic conditions (VTG, n.d.a; n.d.b). There may be opportunities to transport bulk CO₂ by rail over short distances using existing railways, but the high cost of building new dedicated rail lines for large-scale CO₂ transportation makes it uneconomical compared with using pipelines, oceangoing ships, and barges on inland waterways. Tank trucks can be used for short-distance transportation by road, which can be an economical option for volumes of up to 30 tonnes of liquefied CO₂ (stored in cryogenic vessels, typically at 17 bars and -30°C).

CO₂ storage

CO₂ storage infrastructure is composed of the surface and subsurface facilities used to inject CO₂ into geological formations at a depth of at least 800 metres, where it is permanently stored (IEA, 2022a). Suitable storage resources include saline aquifers, depleted oil and gas fields, and other unconventional resources. These resources are unevenly distributed around the world.⁶⁶ Globally, potential resources are ample, but further resource assessment and development is required to prove reserves. Once a resource has been identified, it can take at least three to ten years to develop a functioning CO₂ storage site.

Confidence in the availability of CO₂ storage is a precursor to investment in CO₂ capture facilities, so one of the greatest hurdles in developing CO₂ management infrastructure is accelerating the assessment and development of CO₂ storage resources and developing CO₂ transport infrastructure in parallel with resource assessments. Source-sink matching is used to match sources of captured CO₂ to sinks (storage sites), based on the rate and duration of the supply of the gas (Figure 5.31). It can also support the design of optimised CO₂ transport networks. The expected rate and duration of CO₂ supply from the source needs to match the rate and duration of CO₂ injection that a site or resource can support. Once the two have been matched, transport pathways can be optimised.

⁶⁶ Basalts, peridotites, unmineable coal seams and organic shales can also, in principle, be used for CO₂ storage (IEA, 2022a). Pilot projects for each have been launched, but further demonstration is required to test their technical and economic feasibility. Storage in basalts is the most advanced of these options: the Icelandic company Carbfix has injected more than 80 kt of CO₂ into a basalt reservoir since 2014. The company plans to develop a second site, at which it will inject 500 kt CO₂ per year starting in 2026.

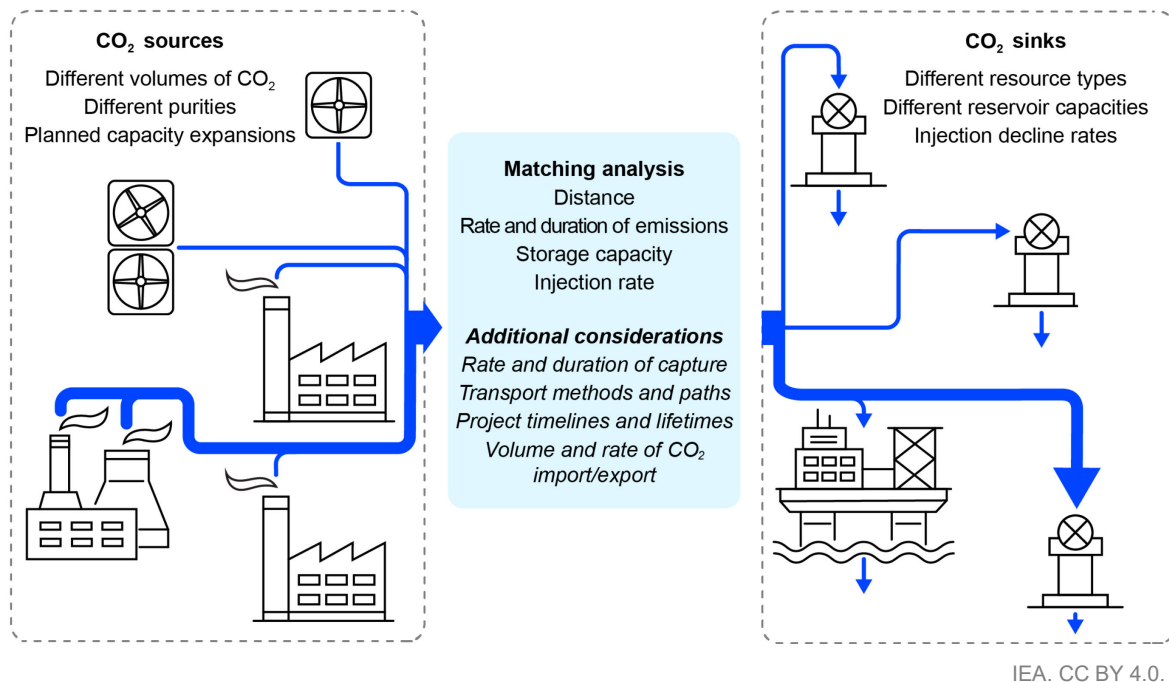
Figure 5.31 Criteria for CO₂ source-sink matching

Note: CO₂ = carbon dioxide.

Source: IEA (2022a).

Source-sink matching is used to pair sources of captured CO₂ with storage sites, based on the rate and duration of sustainable injection.

CO₂ infrastructure needs in the NZE Scenario

The deployment of CO₂ transport and storage infrastructure accelerates rapidly in the NZE Scenario. The total amount of CO₂ captured worldwide is projected to increase from 44 Mt today to 1.2 Gt in 2030 and 6.2 Gt in 2050. Around 95% of all captured CO₂ is stored, so injection capacity for CO₂ storage needs to expand from 42 Mt today to 1.2 Gt in 2030 and 5.9 Gt in 2050. CO₂ transport infrastructure would need to keep pace with this expansion.

Transport

A substantial expansion of CO₂ transport infrastructure in the form of CO₂ pipeline networks, the CO₂ shipping fleet and port infrastructure for CO₂ handling is required to accommodate CCUS deployment in the NZE Scenario. In certain regions, pipelines would most likely become the dominant mode of transport, while other regions may rely on shipping, depending on geographic considerations, existing infrastructure and international trade of CO₂ destined for storage.

In 2021, more than 30 Mt of CO₂ was transported from its point of capture, mainly by pipeline, to oilfields for CO₂-EOR. An additional 10 Mt of CO₂ was transported via pipeline to dedicated storage sites. Global aggregate pipeline length would

by 2030, with some of this capacity used to transport CO₂ to and within ports prior to shipping. The rate of increase in capacity to 2030 will be constrained by the long lead times associated with new pipeline development and construction, and the small number of projects currently under development. According to projects in development, more than 7 000 km of new, multi-user CO₂ pipelines are due to enter into operation by 2030, in addition to six projects involving the repurposing of existing pipelines to create multi-user CO₂ pipelines. By then, around 280 Mt of CO₂ could be transported from points of capture to dedicated CO₂ storage sites or to oilfields for CO₂-EOR,⁶⁷ and around 15 Mt CO₂ could be used either on site or nearby in a variety of products.

CO₂ pipeline infrastructure expands much faster between 2030 and 2050 in the NZE Scenario, mainly to transport captured CO₂ to storage sites, with total pipeline length in 2050 reaching between 100 000 and 600 000 km, depending on whether CO₂ transmission is local, intraregional or interregional (Table 5.6). For comparison, around 650 000 km of crude oil and petroleum product pipelines are in existence today (GlobalData Energy, 2019).

The eventual mix of localised trunklines and short gathering/distribution lines, intraregional transport by pipeline and interregional transport by pipeline or shipping will determine the overall length of the global network.

Shipping CO₂ is more flexible than transporting it by pipeline and can be cost-competitive over long distances and for small volumes (Figure 5.32). For countries and regions with limited access to nearby CO₂ storage, substantial port infrastructure, and emissions located near ports, shipping may be cheaper than building an extensive pipeline network. For shipping to become more efficient, low-pressure CO₂ ships need to be developed. Low-pressure CO₂ ships (5.5 to 9.8 bars and -55°C to -41°C) can carry larger tanks and cargoes than medium-pressure carriers (14 to 20 bars and -30°C to -19.5°C) due to the temperature and pressure at which they operate. Medium-pressure conditions are not practical for ship sizes above 10 000 t CO₂.

⁶⁷ Most CO₂ injected for EOR is retained in the reservoir over a project's lifetime, but additional monitoring and verification are essential to confirm that the CO₂ has been permanently stored.

Table 5.6 CO₂ pipeline deployment for CO₂ capture in the NZE Scenario, 2050

Line type	Description	Deployment concentration	Length (km)	Importance of shipping	Cumulative steel needs (Mt)
Local trunklines	Multi-user trunklines developed between existing industrial clusters and CO ₂ storage resources within 100 km. Gathering lines and distribution lines limited in length.	CO ₂ capture concentrated in industrial clusters located near storage resources or ports. No offshore trunklines between regions.	100 000-200 000	High, as limited offshore pipelines make shipping from regions with little storage to regions with more storage important.	19-39
Intra-regional trunklines	Longer trunklines connecting sources and sinks within a region. Gathering and distribution lines may be longer depending on routing of the trunklines.	CO ₂ capture deployment more widely spread with longer gathering lines connecting geographically distributed emitters to trunklines. Limited regional offshore pipelines.	300 000-400 000	Medium, concentrated in regions more reliant on offshore storage.	58-78
Inter- and intra-regional trunklines	Interregional trunklines crossing countries and regions to move CO ₂ to storage sites.	Geographically dispersed CO ₂ capture. Long interregional trunklines both on- and offshore.	500 000-600 000	Medium to low, concentrated in regions more reliant on offshore storage and in regions with CO ₂ ship-based exports/imports.	97-117

Notes: km = kilometre; Mt = million tonnes.

For capture rates from 0.2 up to 1.6 Mt CO₂/year, Brevik has developed a ship concept based on the design of an existing ship type (Brevik Engineering, 2017). For capacities above 10 000 t CO₂, new designs are needed. Depending on the ship's shape, tanks may need to be arranged one on top the other, which is more complex structurally. Increasing the length of the tanks and the ship would lead to a long and narrow ship, which is not well suited to ports. Demonstrating direct offshore injection can also support the acceleration of ship-based CO₂ transport, since direct injection can eliminate the need to construct onshore receiving terminals and can simplify the infrastructure needed for offshore storage facilities.

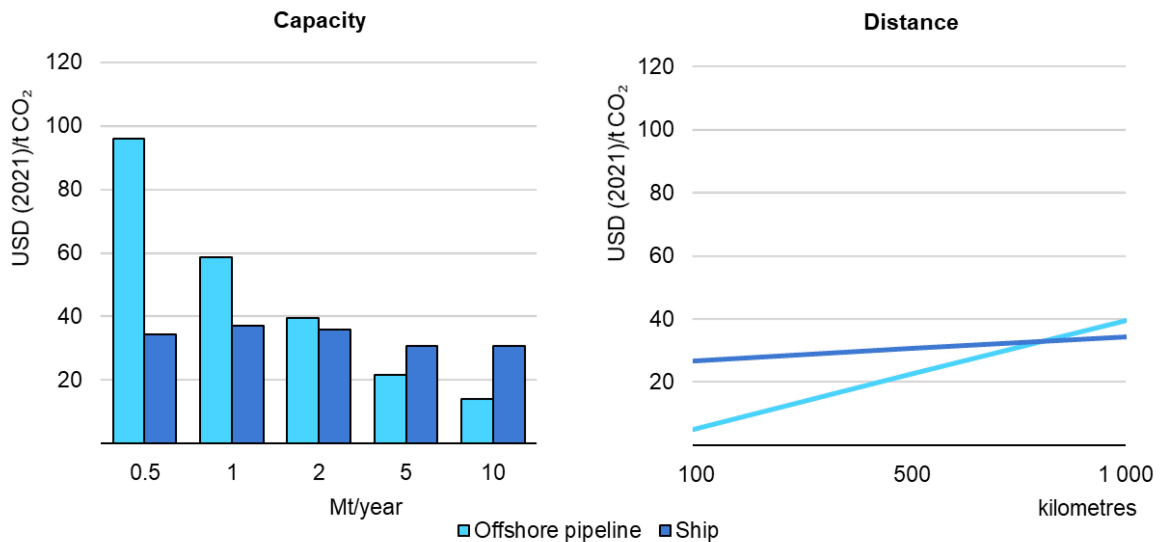
Figure 5.32 Indicative CO₂ shipping and offshore pipeline transportation costs

IEA. CC BY 4.0.

Notes: t CO₂ = tonne of carbon dioxide. Shipping costs based on cryogenic shipping from the Netherlands to Norway. Left-hand chart assumes a distance of 1 000 km, right-hand chart assumes annual capacity of 2 Mt CO₂.

Source: IEAGHG (2020).

Shipping is generally competitive with offshore pipelines for long-distance transportation of small volumes of CO₂.

Storage

There are currently just seven commercial-scale (injection capacity of 100 kt CO₂ per year or greater) dedicated CO₂ storage sites around the world with a total injection capacity of around 10 Mt/year. In addition, captured CO₂ is being injected into oilfields during CO₂-EOR operations, most of which is expected to remain permanently stored. This technology, the use of which is concentrated in the United States, has been the main driver for the construction of CO₂ capture facilities and CO₂ pipelines, though its use will most likely decline during the energy transition in response to lower demand for fossil fuels. The majority of storage projects being pursued today target dedicated storage. A considerable amount of capacity to inject CO₂ into geological formations is in development, but it nonetheless falls short of planned capture capacity expected to be commissioned by 2030 and total storage capacity required in the NZE Scenario (Figure 5.33).

Figure 5.33 Existing and planned annual global CO₂ storage injection capacity, compared with projected NZE Scenario needs in 2030

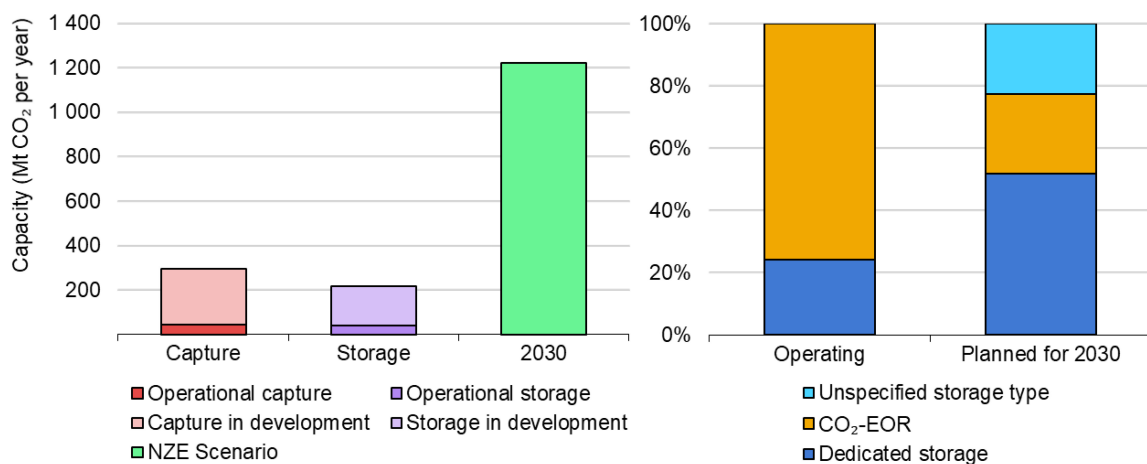

IEA. CC BY 4.0.

Notes: Mt CO₂ = million tonnes of carbon dioxide. Includes commercial-scale projects with CO₂ capture or injection capacity over 100 000 tonnes per year. Capture capacities, storage capacities and planned operation dates come from individual project descriptions. Total CO₂ storage includes plans for dedicated CO₂ storage, CO₂-EOR, and projects to develop CO₂ storage without specifying what kind. Most of the CO₂ injected for EOR is retained in the reservoir over a project’s lifetime, but additional monitoring and verification are essential to confirm that the CO₂ has been permanently stored (IEA, 2015).

Source: Based on IEA tracking and Global CCS Institute data.

Substantial capacity to inject CO₂ into geological formations is already in development, but there is a growing gap between capture and storage injection capacity.

Material and equipment needs

Material needs

Both CO₂ shipping and storage infrastructure rely heavily on steel, while storage also requires large amounts of cement. CO₂ ships require similar kinds of materials as hydrogen ships, though different grades of steel, membrane lines and insulation are used. The amount of steel, its grade and how it is lined depend mainly on the pressure under which the CO₂ is transported. The “Inter- and intraregional trunklines” deployment case has a cumulative steel demand of 97-117 Mt of tubular steel between now and 2050 (Table 5.6). Steel used for CO₂ pipelines in the NZE Scenario makes up only a fraction of the 130 Mt of tubular steel produced annually today. As a result, tubular steel availability is unlikely to limit deployment.

The availability of well construction material and components is also unlikely to constrain the development of shipping or storage capacity, since the increase in demand would be largely offset by declining needs in the upstream and midstream oil and gas sector. The bulk materials required for CO₂ storage are mainly to build injection wells and are therefore similar to those needed for oil and gas wells. They include well casing and tubing, usually made from steel, cement and wellheads

(the surface components of an underground well that provide the structural and pressure-containing equipment for drilling and production). Since CO₂ mixed with water is corrosive, storage wells are sometimes constructed using corrosion-resistant materials, including special types of steel. Portland cement reacts chemically with CO₂, leading to dissolution of alkaline cement phases and precipitation of carbonates, though a few metres of good-quality, well-bonded cement can form an effective CO₂ seal (Carey, 2013; Duguid, 2009). Some projects nevertheless choose to employ specialised cement. Less than 5 Mt of cement in total is required to support CO₂ storage infrastructure that can accommodate injection of 5.9 Gt CO₂ per year (United States, DOE, 2022c). This is negligible compared with current annual global production, suggesting that cement will not restrict deployment of CO₂ management infrastructure.

Equipment needs and manufacturing

For CO₂ ships, equipment needs and manufacturing are broadly similar to hydrogen ships (discussed above), while compressors and pumps, which are integral to CO₂ transportation and storage, are mass-produced for a range of sectors (see Chapter 4). The construction of CO₂ pipelines, shipping and storage infrastructure nonetheless requires some specialised equipment, such as drilling rigs and mechanical devices, along with skilled technicians to operate them. The manufacturing of equipment used for offshore activities, especially drilling rigs and pipelaying equipment, is heavily concentrated in oil- and gas-producing regions. Developers of CO₂ storage sites may need to compete with oil and gas producers for access to drilling rigs, which could cause delays depending on equipment availability. CO₂ storage sites require monitoring equipment. Today, over 50 different types of monitoring technologies have been deployed at sites around the world. Monitoring technologies typically rely on mass-manufactured equipment and should not curtail CO₂ storage deployment. However, the expertise required to analyse the results of monitoring programmes is limited and could present a bottleneck if steps are not taken to expand related competencies.

Lead times

Lead times to deploy CO₂ management infrastructure vary by infrastructure type and region. Currently, the majority of CCUS projects have been developed in a full-chain manner, meaning that projects include capture, transport and storage of CO₂. This makes identifying the exact lead times for CO₂ infrastructure difficult. Nonetheless, infrastructure for CO₂ storage would be expected to take longer to develop than for CO₂ capture or CO₂ transport due to the need for resource assessments. Since confidence in CO₂ storage must be gained before construction of CO₂ capture facilities and CO₂ transport infrastructure can advance, resource assessment usually proceeds first.

Globally, very few potential CO₂ storage resources – the amount of capacity in both discovered and undiscovered deposits – have been declared proven reserves (discovered resources of a known size, for which exploitation is considered technically and economically feasible). It can take three to ten years to build a storage facility once the resource has been identified, depending on a number of factors, including ease of access to the resource, its geological characteristics and planning procedures and rules (Figure 5.34). Some countries and regions have performed national or regional resource assessments, but such assessments usually focus on the volume of pore space available for storage and rarely provide estimates of potential sustainable rates of injection. Both factors are essential to determine how much CO₂ should be transported to the potential storage site and what rate CO₂ can be captured at.

Figure 5.34 Lead times for the CO₂ storage component of selected CCUS projects with dedicated storage

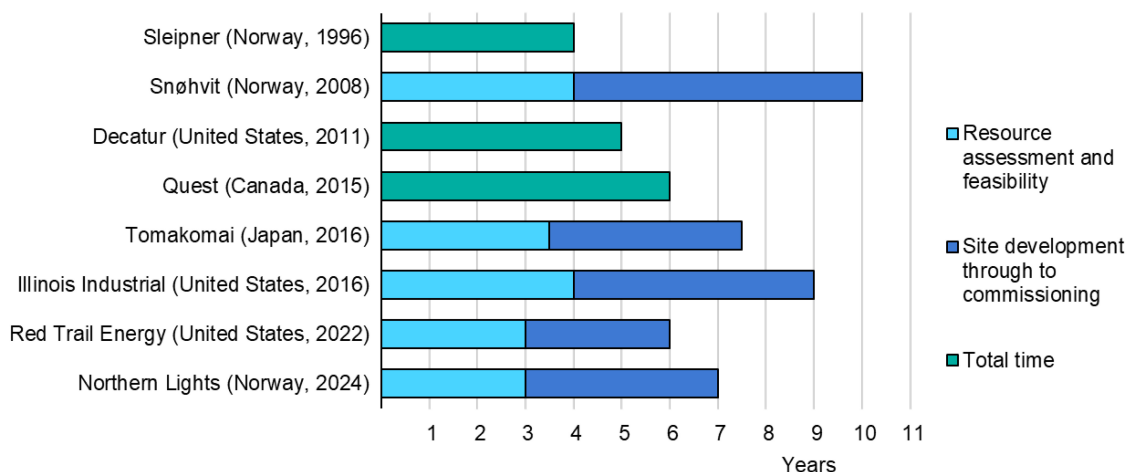

IEA. CC BY 4.0.

Notes: Years in brackets refer to commissioning date. Assessment of the Sleipner and Snøhvit resources occurred during the development of nearby gas resources.

Sources: Industry sources and IEA research.

Resource assessment makes up a significant portion of CO₂ storage project lead times.

Subsurface data collection takes time and can be very expensive. In some cases, data collected during oil and gas exploration and production can be used to assess the potential for CO₂ storage. However, such data is typically proprietary and access may be restricted. Depleted oil and gas fields may be faster to develop due to the extensive data already collected on them. Permitting procedures can greatly extend lead times for developing storage sites, especially in countries lacking a legal and regulatory framework for CCUS (IEA, 2022f). Lead times for CO₂ storage can be reduced through precompetitive assessments of CO₂ storage resources and dedicated data collection campaigns (IEA, 2022a).

Lead times to build CO₂ transport infrastructure depend on the type of infrastructure required. In the case of CO₂ pipelines, six to nine years have been observed for new-build pipelines, which is similar to oil and natural gas pipelines (Figure 5.35). Lead times for CO₂ tankers and barges are likely to be similar to those for liquified hydrogen tankers, for which construction could be constrained by shipyard capacity and booked orders. No commercial-scale CO₂ shipping terminals are operating as yet, though Northern Lights is building a CO₂ import terminal in Norway. Based on the project’s announced timeline, around five years could be required to design and construct the infrastructure required to transport and store CO₂, including liquefaction facilities, temporary storage, and loading and unloading equipment.

Figure 5.35 Lead times of selected recent natural gas and CO₂ pipeline projects

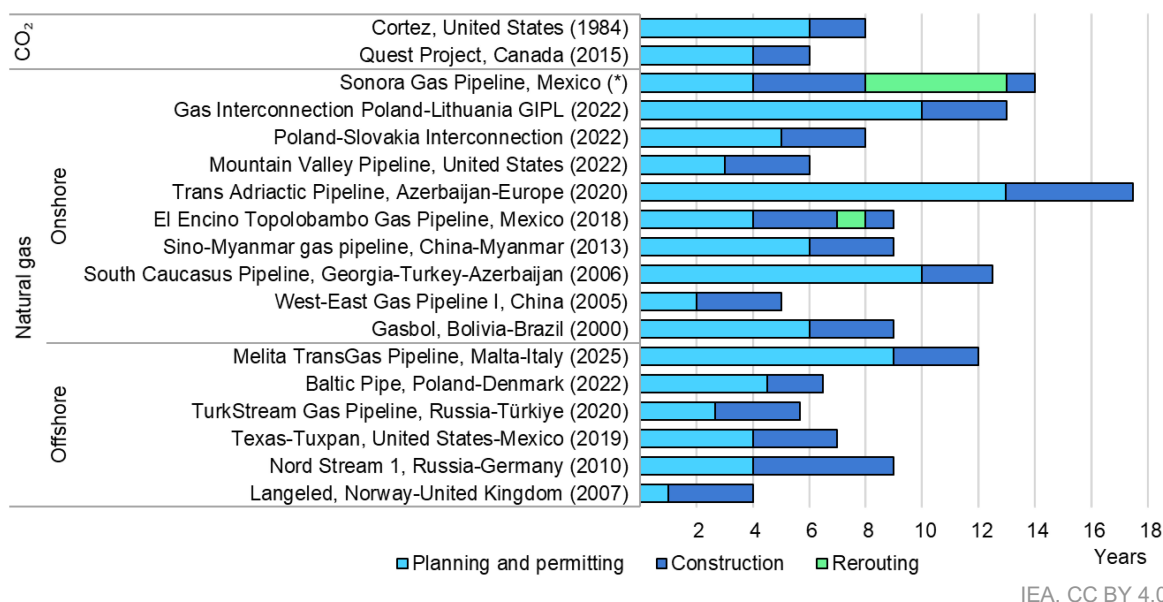

* Construction has started but the commissioning date is uncertain.

Notes: Year of commissioning is indicated in parentheses. The Trans Adriatic Pipeline connects Azerbaijan to Greece and Albania, where an offshore pipeline in the Adriatic Sea connects with Southern Italy.

Planning and permitting of most recent pipelines took two to eight years, with construction usually lasting about 3 years for both onshore and offshore projects.

Energy needs and emissions

Following its capture, preparing CO₂ for transport will include compression, removing impurities present in the stream, dehydration and/or liquefaction. Compression and liquefaction are highly energy-intensive, so the choice of energy has a significant impact on emissions intensity. Electrification can reduce emissions from CO₂ transport and storage infrastructure. Shipping companies are exploring electric ships for short-range shipping and barging, as well ship-based CO₂ capture. Emissions can also come from leaks, but they can be minimised with the use of effective leak detection and repair programmes. In the case of dedicated

CO₂ storage, the risk of leakage is small if wells are sealed correctly and if well-functioning measurement, monitoring and verification programmes are in place. While most of the CO₂ injected for EOR is retained in the reservoir over the lifetime of a project, additional monitoring and verification are essential to confirm that the CO₂ has been permanently stored. Containment is a key selection criterion for dedicated CO₂ storage sites.

Focus on repurposing existing infrastructure

The NZE Scenario's pathway to net zero emissions involves a rapid and immediate decline in the consumption of oil and natural gas. As a result, certain oil and gas sector assets such as platforms, gas networks and shipping terminals would quickly become stranded. This existing infrastructure could potentially be repurposed or reused to fast-track the deployment of CO₂ or hydrogen infrastructure, reducing lead times and the amount and cost of new infrastructure that would need to be built. Repurposing can also shrink a project's environmental footprint by reducing new material demands and construction needs, and it can help infrastructure owners maximise the economic lifetime of their assets while reducing or deferring decommissioning costs. Existing infrastructure needs to be assessed on an individual basis to determine whether it is suitable for repurposing and what modifications are required. Infrastructure owners should be encouraged to incorporate a reuse audit in their decommissioning process to aid repurposing endeavours.

New and existing natural gas infrastructure can be used to transport and store biomethane or synthetic methane, which have almost identical physical and chemical characteristics to natural gas. Some reconfiguration may be needed to accommodate more decentralised production, particularly for biomethane, and differences in gas quality. Existing oil-related infrastructure can be used to transport and store LOHCs and liquid synthetic fuels, though there are some safety considerations for certain chemicals used as LOHCs.

The physical and chemical properties of CO₂ and hydrogen are different from natural gas and oil, so some reconfiguration and adaptation would be required for existing transport and storage infrastructure to be repurposed (Table 5.7).

For hydrogen, there are several projects assessing the feasibility of repurposing natural gas pipelines and decommissioned underground natural gas storage facilities (IEA, 2022b), and although experience in repurposing LNG terminals for LH₂ or ammonia is lacking, feasibility is being discussed in the context of planned LNG import capacity expansions in Europe. For CO₂, some pipelines have already been repurposed and several other projects are assessing further pipeline repurposing (Table 5.9). Some of the infrastructure found in depleted oil and gas fields, including wells and site facilities, may possibly be reused for CO₂ storage activities.

Table 5.7 Fossil fuel infrastructure with potential for repurposing for transporting or storing hydrogen and CO₂

Infrastructure type	Hydrogen	CO ₂
Pipelines*	●	●
Offshore platforms	●	●
Well infrastructure	-	● to ●
Natural gas shipping terminals	● to ●	● to ●
Subsea systems	-	● to ●
Underground gas storage [†]	● to ●	-

● high potential ● moderate potential ● low potential

*In the case of hydrogen pipelines, repurposing mainly targets natural gas transmission lines.

[†] This does not consider depleted gas fields, but rather existing underground natural gas storage.

Note: Subsea systems are the underwater infrastructure used to produce oil or gas or to inject CO₂.

Repurposing oil and gas pipelines for hydrogen and CO₂

In principle, existing pipelines can be repurposed to transport either CO₂ or hydrogen (Table 5.8). The suitability of a pipeline for repurposing and the technical modifications required depend on its design and operational parameters, including the type of steel, the age and condition of the line, welding and operating pressure. The economic case for repurposing hinges on three basic conditions:

- The existence of unused pipelines or under-utilised loop pipelines, wherein one or more lines could be repurposed for pure hydrogen and/or CO₂ while the other line(s) remain in operation.
- Proximity of the pipeline to both the sources and destinations of the hydrogen or CO₂, with relatively large volumes of minimum market uptake.
- Favourable market factors, including the cost of building new hydrogen pipelines versus CO₂ pipelines or other alternative means of transport.

Conversion of an existing pipeline must not compromise its safety or integrity, which can be maintained with appropriate technical modifications. Nonetheless, it is necessary to develop new standards and regulations specifically for repurposing. For example, there is no defect assessment code for repurposed pipelines to determine which pre-existing defects could be considered acceptable.

So far, only one natural gas pipeline has been converted to carry pure hydrogen – a 12-km line in the Netherlands (Gasunie, 2018). The Dutch government has announced it will invest EUR 750 million to develop a 1 400-km national hydrogen

transmission network by 2026-2031, of which 85% will comprise repurposed natural gas pipelines. Gas transmission system operators in other countries, including Belgium, Denmark, Germany, Italy, Spain and United Kingdom, have announced plans to repurpose parts of their networks to hydrogen (IEA, 2022b).

Table 5.8 Technical aspects of repurposing oil and gas pipelines for hydrogen and CO₂ transport

Specification	Hydrogen	CO ₂
Standards	Onshore: ASME B31.12 Offshore: no standard*	ISO 27913:2016 or DNVGL-RP-F104 (onshore and offshore)
Wall thickness	Given by the repurposed pipeline	Given by the repurposed pipeline
Maximum allowable operating pressure	For onshore lines, possible to calculate according to the ASME B31.12 standard, depending on wall thickness, pipeline diameter and steel strength	Dependent on the pipeline's maximum allowable operating pressure and on the phase CO ₂ is being transported in
Metallic material integrity	Risk of embrittlement, resulting in limitations when using higher-strength steel, as hydrogen can induce a reduction in ductility	Corrosion risks from CO ₂ when mixed with water or from specific impurities. Risk of brittle fracture, depending on operational parameters
Non-metallic material integrity	Risk of leakage and material degradation	Low-temperature brittleness and material or chemical degradation
Internal coatings	Exceeding erosion velocity due to hydrogen flowing at high speed (~60 m/s) may affect the internal flow coating, increasing friction and pressure losses	Anti-corrosion coatings can be used to reduce friction; however, some internal coatings may be incompatible with CO ₂
Free-spanning offshore pipelines	Fatigue crack growth rate induced and fracture resistance reduced in existing lines due to lateral buckling caused by waves, leading to a higher risk of embrittlement	Higher weight of CO ₂ compared with methane can increase mechanical stress.

* Although there is no standard for offshore hydrogen transmission by pipeline, the H2Pipe project is revising the feasibility of adapting the DNV-ST-F101 standard for submarine pipeline systems (DNV, 2021).

Notes: m/s = metre per second. Non-metallic pipeline elements include seals and elastomers. Free-spanning offshore pipelines are suspended above the seabed, so are subject to more vibration than buried pipelines.

The European Hydrogen Backbone initiative, which includes 31 European gas infrastructure operators (from 25 EU member states and Norway, Switzerland and the United Kingdom), suggests an initial 28 000-km hydrogen pipeline network by 2030 and around 53 000 km by 2040, of which about 60% would be repurposed natural gas pipelines (European Hydrogen Backbone, 2022). Other countries, such as Canada, Chile, India, Japan, Korea and Mexico, are also exploring the

possibility of repurposing their natural gas pipelines (DNV, 2022b; Canada, NRCAN, 2020). At least two trunklines have already been repurposed for CO₂, and a number of other projects are being considered (Table 5.9).

Table 5.9 Existing and planned projects to repurpose natural gas pipelines to carry CO₂

Project	Pipeline	Original target resource	Country	Length (km)	Diameter (inches)	Status
Acorn	Goldeneye	Gas	United Kingdom	102	20	In development
Humber Zero	LOGGS 36" trunkline	Gas	United Kingdom	118	36	In development
Neptune Energy L10-area	Unspecified	Gas	Netherlands			In development
Cranfield EOR	West Gwinville Pipeline	Gas	United States	80	18	Operating since 2008
OCAP	OCAP pipeline	Oil	Netherlands	97	26	Operating since 2005

Notes: OCAP = organic carbon dioxide for assimilation in plants. EOR = enhanced oil recovery. LOGGS = Lincolnshire Offshore Gas Gathering System. km = kilometre.

Sources: OCAP (n.d.); Offshore Engineer (2021); Denbury (n.d.); Chrysaor (2021); Humber Zero (n.d.); Shell (2019); Ros et al. (2014).

New oil and gas pipelines are still being built, either to replace existing ones or to connect new areas. It is vital that developers of this new infrastructure consider the potential to make these pipelines hydrogen- or CO₂-ready at the design phase to reduce future repurposing costs and minimise the risk of stranded assets. Making access to public funding conditional on such design requirements is one approach (see Chapter 6). For example, in the revised EU Trans-European Networks for Energy (TEN-E) regulation, which entered into force in June 2022, natural gas and oil pipelines are (with a few exceptions) ineligible for classification as Projects of Common Interest (PCI), which benefit from faster permitting and regulatory approval as well as EU financial assistance (European Commission, 2022c). Hydrogen and CO₂ pipelines used for natural gas during an interim period can benefit from PCI status.

In the case of hydrogen-ready pipelines, the goal is to ensure that new natural gas pipelines can transport gaseous hydrogen or hydrogen-natural gas mixtures without additional design limitations once repurposed (i.e. the pipeline would not have to operate at a lower pressure, which would reduce the volumetric density of the transported hydrogen and therefore the amount being transported). For example, some new pipelines being considered as hydrogen-ready are certified according to the ASME B31.12 Option B standard (see Hydrogen Pipelines

section above). It is estimated that repurposing natural gas pipelines to transport hydrogen could cut investment costs by 50-80% relative to building new lines (IEA, 2022b). Onshore natural gas pipelines are already being built or upgraded to be hydrogen-ready in Italy, Poland, Greece and Australia (Snam, 2021; Corinth Pipeworks, 2022; Gas Pathways, 2022; Cenergy, 2022).

When repurposing is not technically feasible and/or natural gas demand remains significant, building new hydrogen and/or CO₂ pipelines alongside existing natural gas ones could nonetheless benefit from established right-of-way and siting permits, thereby reducing costs and shortening lead times for pipeline development. Co-routing different new pipelines parallel to each other in the same right of way can also reduce construction time, cost and environmental impact compared with laying pipelines independently. The Delta Corridor project in the Netherlands includes the construction of parallel 400-km pipelines for hydrogen, CO₂, LPG and propylene, with cost savings estimated at around 30% (Port of Rotterdam, 2021).

Repurposing LNG terminals

In response to the energy crisis caused by the Russian invasion of Ukraine, several countries in Europe are looking into alternative gas supply options, including increased imports of LNG, which would require the construction of new import terminals, while the largest regasification capacity under construction is still in the Asia Pacific region. While new infrastructure can help diversify natural gas supplies in the short term, the long lifetimes of such facilities mean that this infrastructure could become locked in, making it harder to transition to a decarbonised energy system. New facilities must therefore be designed and built in a way that facilitates their later conversion for purposes related to hydrogen, hydrogen-based fuels or ammonia to minimise the risk of stranded assets, accelerate the deployment of low-emission fuels and reduce investment needs and lead times. Planning for conversion during terminal design is critical to enable the future transition to other fuels, as repurposing – especially for liquefied hydrogen – may not be possible for core components. In contrast with pipelines, no practical experience exists in repurposing LNG terminals for hydrogen or ammonia, but the following options could be explored (IEA, 2022b):

- **Repurposing import LNG terminals for LH₂:** Due to the lower temperature and density of LH₂ compared with LNG, repurposing an existing LNG terminal is technically very complex. In particular, the LNG storage tank would need to be replaced to avoid excessive boil-off rates, and pipe insulation would need to be changed to minimise energy losses. If any converted equipment is not sufficiently insulated, surrounding oxygen in the air could condense around the surfaces and create an explosion risk, as oxygen's dew point is above hydrogen's.

- **Designing new liquefied hydrogen import terminals for initial LNG use:** New LH₂ terminals could be designed to be used initially for LNG. Due to the higher temperature of LNG, part of the equipment (such as tank and pipe insulation) would need to be over-designed for LNG use, but this should not lead to any major technical problems. Other components, such as pumps, would require specific design and configuration to be compatible with the density difference of the two fluids.
- **Repurposing LNG terminals for ammonia:** As the boiling temperature of ammonia is well above that of LNG, it can be more easily handled. Some modifications would be needed, such as pump replacement and adjustments to the boil-off-gas system, but they are less complex than those required to repurpose for LH₂. Because ammonia is heavier than LNG, storage tank capacity would be lower for ammonia.
- **Designing new LNG import terminals to be ammonia-ready:** It is possible to plan for future ammonia accommodation when designing new LNG terminals, considering the heavier weight of ammonia compared with LNG for the storage tank. Some components, such as pumps, would still need to be replaced.
- **Repurposing LNG terminals for CO₂:** Due to the low temperature and pressure of LNG, regasification terminals are unlikely to be suitable for repurposing for CO₂, which needs to be stored at a higher temperature and pressure. However, some loading/unloading infrastructure may be able to handle CO₂.

Depending on an LNG terminal's design, age and condition, repurposing opportunities may be limited. Brownfield developments may make it possible to reuse some elements such as the jetty, power connections and land foundations (especially relevant at congested ports with space constraints), and could help reduce lead times.

References

- Air Liquide (2020), Air Liquide will build the first high-pressure hydrogen refueling station for long-haul trucks in Europe, 1 July, www.airliquide.com/group/press-releases-news/2020-07-01/air-liquide-will-build-first-high-pressure-hydrogen-refueling-station-long-haul-trucks-europe
- Al Baroudi, H. et al. (2021), A review of large-scale CO₂ shipping and marine emissions management for carbon capture, utilisation and storage, *Applied Energy*, Vol. 287, 116510, <https://www.sciencedirect.com/science/article/pii/S0306261921000684>
- APPA (American Public Power Association) (2022), APPA Survey of Members Shows Distribution Transformer Production Not Meeting Demand, 12 October, <https://www.publicpower.org/periodical/article/appa-survey-members-shows-distribution-transformer-production-not-meeting-demand>
- Baltic Pipe Project (2022), GAZ-SYSTEM completed Baltic Pipe construction, 27 September, <https://www.baltic-pipe.eu/gaz-system-completed-baltic-pipe-construction/>
- Bangkok Post (2022), Europe's Natural-Gas Crunch Sparks Global Battle for Tankers, 24 August, <https://www.bangkokpost.com/business/2375570/europes-natural-gas-crunch-sparks-global-battle-for-tankers/>
- Borri, E. et al. (2022), Compressed Air Energy Storage – An Overview of Research Trends and Gaps through a Bibliometric Analysis, *Energies*, Vol.15/20, 7692, <https://doi.org/10.3390/en15207692>
- Brevik Engineering (2017), CO₂ ship transport study, <https://www.brevik.com/project/co2-ship-transport-study/>
- Brun, F. (2017), Korea and the Shipbuilding Global Value Chain, Duke GVC Center, 29 September, www.globalvaluechains.org/cggclisting/chapter-4-korea-and-the-shipbuilding-global-value-chain/
- Bushveld Minerals (2022), About Vanadium, <https://www.bushveldminerals.com/about-vanadium/>
- Canada, NRCAN (Natural Resources Canada) (2020), Hydrogen strategy for Canada, https://www.nrcan.gc.ca/sites/nrcan/files/environment/hydrogen/NRCan_Hydrogen-Strategy-Canada-na-en-v3.pdf
- Carbon Collectors (n.d.), CO₂ transport and storage: This is how it is done, <https://carboncollectors.nl/co2-transport-storage/>
- Carey, J.W. (2013), Geochemistry of wellbore integrity in CO₂ sequestration: Portland cement-steel-brine-CO₂ interactions, *Reviews in Mineralogy and Geochemistry*, Vol. 77/1, pp. 505-539. <https://doi.org/10.2138/rmg.2013.77.15>
- Cedigaz (2018), CEDIGAZ Natural Gas Statistical Databases, www.cedigaz.org/databases/
- Cenergy (2022), Corinth Pipeworks wins contract in Australia for hydrogen certified linepipe, 28 March, <https://cenergyholdings.com/new/corinth-pipeworks-wins-contract-in-australia-for-hydrogen-certified-linepipe-2/>
- CEPII (Centre d'Études Prospectives et d'Informations Internationales) (2022), International Trade Database at the Product Level, www.cepii.fr/CEPII/en/bdd_modele/bdd_modele.asp

- China, Ministry of Commerce. (2021). 中华人民共和国取向电工钢产业申请对原产于日本、韩国和欧盟的进口取向电工钢所适用的反倾销措施进行期终复审调查 [Application for an end-of-term review investigation on the anti-dumping measures applicable to imports of grain-oriented electrical steel originating in Japan, South Korea and the EU], <http://images.mofcom.gov.cn/trb/202107/20210723084832649.pdf>
- Chrysaor (2021), Decommissioning Programmes LOGGS Installation & North Valiant PD, LDP5, https://assets.publishing.service.gov.uk/government/uploads/system/uploads/attachment_data/file/978321/LDP5_Decommissioning_Programme.pdf
- Clean Hydrogen Joint Undertaking (2022), Strategic Research and Innovation Agenda 2021-2027, www.clean-hydrogen.europa.eu/about-us/key-documents/strategic-research-and-innovation-agenda_en
- Corinth Pipeworks (2022), Hydrogen certified pipes for the Polish Gas Network delivered by Corinth Pipeworks, <https://www.cpw.gr/en/media-center/news-events/newsevent-hydrogen-certified-pipes-for-the-polish-gas-network-delivered-by-corinth-pipeworks>
- Danish Ship Finance (2022), Shipping Market Review 2022, <https://www.shipfinance.dk/media/2209/shipping-market-review-may-2022.pdf>
- DART (Data Analysis, Retrieval and Transfer System) (2022), 대우조선해양 단일판매 · 공급계약 체결 2022.10.04 [Daewoo Shipbuilding & Marine Engineering, Signed a single sales/supply contract 2022.10.04], <https://dart.fss.or.kr/dsaf001/main.do?rcpNo=20221004800208>
- Denbury (n.d.), Gulf Coast Pipelines, <https://www.denbury.com/operations/operations-overview/gulf-coast-region/Pipelines/default.aspx>
- DNV (2022a), Smells like sustainability: Harnessing ammonia as ship fuel, Maritime Impact, 8 February, <https://www.dnv.com/expert-story/maritime-impact/Harnessing-ammonia-as-ship-fuel.html>
- DNV (2022b), DNV and Pipeline Infrastructure Limited (PIL) collaborate to integrate hydrogen into PIL gas network assets in India, 14 July, <https://www.dnv.com/news/dnv-and-pipeline-infrastructure-limited-pil-collaborate-to-integrate-hydrogen-into-pil-gas-network-assets-in-india-227964>
- DNV (2021), Transportation of hydrogen gas in offshore pipelines: H2Pipe, www.dnv.com/article/transportation-of-hydrogen-gas-in-offshore-pipelines-h2pipe-213006
- Duguid, A. (2009). An estimate of the time to degrade the cement sheath in a well exposed to carbonated brine, Energy Procedia, Vol. 1/1, pp. 3181-3188, <https://doi.org/10.1016/j.egypro.2009.02.101>
- Energiechronik (2020), Verkabelung der SüdLink-Trassen kostet zwei Milliarden Euro [Cabling the SüdLink routes costs two billion euros], June, www.energie-chronik.de/200617.htm
- ENTSO-E and Europacable (2018), Forecast demand and manufacturing capacity for HVAC and HVDC underground and submarine cables, www.entsoe.eu/Documents/TYNDP%20documents/TYNDP2018/position_paper_signed.pdf

- European Commission (2022a), Commission Implementing Regulation (EU) 2022/58 of 14 January 2022 imposing a definitive anti-dumping duty on imports of certain grain-oriented flat-rolled products of silicon-electrical steel originating in the People's Republic of China, Japan, the Republic of Korea, the Russian Federation and the United States of America following an expiry review pursuant to Article 11(2) of Regulation (EU) 2016/1036 of the European Parliament and of the Council, https://eur-lex.europa.eu/eli/reg_impl/2022/58/oj
- European Commission (2022b), Mergers: Commission prohibits proposed acquisition of Daewoo Shipbuilding & Marine Engineering by Hyundai Heavy Industries Holdings, https://ec.europa.eu/commission/presscorner/detail/en/IP_22_343
- European Commission (2022c), Regulation (EU) 2022/869 of the European Parliament and Council on guidelines for trans-European energy infrastructure, <https://eur-lex.europa.eu/legal-content/EN/TXT/PDF/?uri=CELEX:32022R0869&from=EN>
- European Commission (2021), Technical support for RES policy development and implementation: Simplification of permission and administrative procedures for RES installations (RES Simplify), Interim report, <https://op.europa.eu/en/publication-detail/-/publication/0e9db9fa-d653-11ec-a95f-01aa75ed71a1/language-en>
- European Commission (2019), Regulation (EU) 2019/1783 on ecodesign requirements for small, medium and large power transformers, https://eur-lex.europa.eu/legal-content/EN/TXT/?uri=uriserv%3A0J.L_2019.272.01.0107.01.ENG&toc=OJ%3AL%3A2019%3A272%3ATOC
- European Council (2022), EU to speed up permitting process for renewable energy projects, Press release, 24 November, <https://www.consilium.europa.eu/en/press/press-releases/2022/11/24/eu-to-speed-up-permitting-process-for-renewable-energy-projects/#:~:text=The%20Council%20agreed%20on%20a,be%20permitted%20within%20three%20months>
- European Hydrogen Backbone (2022), A European hydrogen infrastructure vision covering 28 countries, <https://ehb.eu/files/downloads/ehb-report-220428-17h00-interactive-1.pdf>
- Gas Pathways (2022), Greece to build 163 km of hydrogen-ready pipeline, 7 February, <https://gaspathways.com/greece-to-build-163-km-of-hydrogen-ready-pipeline-616>
- Gasunie (2018), Gasunie hydrogen pipeline from Dow to Yara brought into operation, 27 November, <https://www.gasunie.nl/en/news/gasunie-hydrogen-pipeline-from-dow-to-yara-brought-into-operation>
- GE Grid Solutions (2017), Green Power Transformers, https://www.gegridsolutions.com/products/brochures/power_transformers/grid-ptr-l3-green_transformers-0299-2017_03-en.pdf
- Germany, BMWK (Bundesministerium für Wirtschaft und Klimaschutz/Federal Ministry for Economic Affairs and Climate Action) (2022), Federal cabinet adopts tool to help formulate LNG Acceleration Act, 10 May, <https://www.bmwk.de/Redaktion/EN/Pressemitteilungen/2022/05/20220510-federal-cabinet-adopts-tool-to-help-formulate-lng-acceleration-act.html>
- GIE (Gas Infrastructure Europe) (2021), Gas Storage Europe Database, <https://www.gie.eu/transparency/databases/storage-database/> (accessed 1 October 2022).

- GlobalData Energy (2019), North America has the highest oil and gas pipeline length globally, Offshore Technology, 4 December, <https://www.offshore-technology.com/comment/north-america-has-the-highest-oil-and-gas-pipeline-length-globally/>
- Golisch, G. et al. (2022), Application of line pipe and hot induction bends in hydrogen gas, Journal of Pipeline Science and Engineering, Vol. 2/3, 100067, <https://doi.org/10.1016/j.jpse.2022.100067>
- González Díez, N. et al. (2022), Impact of high speed hydrogen flow on system integrity and noise, <https://doi.org/10.5281/zenodo.5901833>
- GTT (Gaztransport & Technigaz) (2022), Vessels and land storages on order, <https://gtt.fr/references-partners/order-book>
- HESC (Hydrogen Energy Supply Chain) (2022), The world-first Hydrogen Energy Supply Chain Project, www.hydrogenenergysupplychain.com/
- Humber Zero (n.d.), Humber Zero: Planning for a low-carbon future in the Humber, ICEME, <https://www.icheme.org/media/15296/humber-zero-icheme-hull-and-the-humber-29012021.pdf>
- Hystock (2022), Hydrogen Storage in Salt Caverns, <https://www.hystock.nl/en/hydrogen/storage-in-salt-caverns>
- ICIS (Independent Commodity Intelligence Services) (2022), ICIS LNG Edge,
- IEA (International Energy Agency) (2022a), CO₂ Storage Resources and their Development, <https://iea.blob.core.windows.net/assets/42d294af-ce07-44c7-9c96-166f855088e8/CO2storageresourcesandtheirdevelopment-AnIEACCUSHandbook.pdf>
- IEA (2022b), Global Hydrogen Review 2022, www.iea.org/reports/global-hydrogen-review-2022
- IEA (2022c), Global Energy and Climate Model – Documentation, <https://iea.blob.core.windows.net/assets/3a51c827-2b4a-4251-87da-7f28d9c9549b/GlobalEnergyandClimateModel2022Documentation.pdf>
- IEA (2022d), Gas Market Report, Q4-2022 <https://iea.blob.core.windows.net/assets/318af78e-37c8-425a-b09e-ff89816ffeca/GasMarketReportQ42022-CCBY4.0.pdf>
- IEA (2022e), ETP Clean Energy Technology Guide 2022, www.iea.org/data-and-statistics/data-tools/etp-clean-energy-technology-guide
- IEA (2022f), Legal and Regulatory Frameworks for CCUS, <https://www.iea.org/reports/legal-and-regulatory-frameworks-for-ccus>
- IEA (2021), Ammonia Technology Roadmap, www.iea.org/reports/ammonia-technology-roadmap
- IEA (2015), Storing CO₂ through Enhanced Oil Recovery, <https://www.iea.org/reports/storing-co2-through-enhanced-oil-recovery>
- IEAGHG (IEA Greenhouse Gas R&D Programme) (2020), The status and challenges of CO₂ shipping infrastructure, <http://documents.ieaghg.org/index.php/s/YKm6B7zikUpPgGA?path=%2F2020%2FTechnical%20Reports>
- IGU (International Gas Union) (2022), Working Committee 2 - Underground Gas Storage Database, http://ugs.igu.org/index.php/ugs_list/get_list

- IMO (International Maritime Organization) (2020), Fourth Greenhouse Gas Study 2020, <https://www.imo.org/en/OurWork/Environment/Pages/Fourth-IMO-Greenhouse-Gas-Study-2020.aspx>
- Knoope, M.J., A. Ramírez and A.C. Faaij (2013), Economic Optimization of CO₂ Pipeline Configurations, *Energy Procedia*, Vol. 37, pp. 3105-3112, <https://doi.org/10.1016/j.egypro.2013.06.196>
- Langenbrunner, B., J. Joly and G. Aitken. (2022), Pipe dreams: Stranded assets and magical thinking in the proposed global gas pipeline buildout, https://globalenergymonitor.org/wp-content/uploads/2022/02/GEM_GasPipelineReport2022_r7.pdf
- Marcinkoski, J. et al. (2019), US DOE Hydrogen and Fuel Cell Technologies Office Program Record 19006: Hydrogen Class 8 Long Haul Truck Targets, https://www.hydrogen.energy.gov/pdfs/19006_hydrogen_class8_long_haul_truck_targets.pdf
- Martin, M.L. et al. (2022), Evaluating a natural gas pipeline steel for blended hydrogen service, *Journal of Natural Gas Science and Engineering*, Vol. 101, 104529, <https://doi.org/10.1016/j.jngse.2022.104529>
- MOL (Mitsui O.S.K. Lines) (2021), MOL Group's Phoenix Tankers Signs Deal for Construction of LPG Fuelled VLGCs for LPG/Ammonia Transport, 5 August, <https://www.mol.co.jp/en/pr/2021/21065.html>
- Monsma, V. (2022), Challenges of converting existing natural gas pipelines to hydrogen service, including high-grade steels, *Proceedings of Pipeline Technology Conference 2022*, Berlin, <https://www.pipeline-conference.com/abstracts/challenges-converting-existing-natural-gas-network-including-high-grade-steel-pipelines>
- Netbeheer Nederland (2019), Basisinformatie over energie-infrastructuur [Basic information about energy infrastructure], https://www.netbeheernederland.nl/_upload/Files/Basisdocument_over_energie-infrastructuur_143.pdf
- Neuman & Esser Group (2022), Storing Hydrogen, <https://www.neuman-esser.de/en/company/media/blog/hydrogen-storage-in-salt-caverns/>
- NREL (National Renewable Energy Laboratory) (2021), A Circular Economy for Lithium-Ion Batteries Used in Mobile and Stationary Energy Storage: Drivers, Barriers, Enablers, and U.S. Policy Considerations, <https://www.nrel.gov/docs/fy21osti/77035.pdf>
- OCAP (n.d.), About OCAP, Factsheet, https://www.ocap.nl/nl/images/OCAP_Factsheet_English_tcm978-561158.pdf
- Offshore Engineer (2021), DNV, Neptune Studying if Offshore Pipelines Can Be Reused for CO₂ Transport, June, <https://www.oedigital.com/news/488620-dnv-neptune-studying-if-offshore-pipelines-can-be-reused-for-co2-transport>
- Onyebuchi, V.E. et al., (2018), A systematic review of key challenges of CO₂ transport via pipelines, *Renewable and Sustainable Energy Reviews*, Vol. 81/2, pp. 2563-2583. <https://doi.org/10.1016/j.rser.2017.06.064>
- Port of Rotterdam (2021), Feasibility study for Port of Rotterdam-Chemelot-North Rhine-Westphalia pipelines, https://www.portofrotterdam.com/sites/default/files/2021-06/202104id-095_delta_corridor_en.pdf
- Rand, J. et al. (2022), Queued up: Characteristics of Power Plants Seeking Transmission Interconnection, Lawrence Berkeley National Laboratory, <https://emp.lbl.gov/queues>

- Ros, M. et al. (2014), Start of a CO₂ Hub in Rotterdam: Connecting CCS and CCU, *Energy Procedia*, Vol. 63, pp. 2691-2701, <https://doi.org/10.1016/j.egypro.2014.11.291>
- RTE international (2022), HVDC-VSC Newsletter, <https://www.rte-international.com/newsletter-hvdc/?lang=en>
- Rystad Energy (2022), GasMarketCube database.
- Shell (2019), Goldeneye Decommissioning Programmes, https://assets.publishing.service.gov.uk/government/uploads/system/uploads/attachment_data/file/846268/GDP-PT-S-AA-8203-00001_A08_final.pdf
- Simandl, G.J. and S. Paradis (2022), Vanadium as a critical material: Economic geology with emphasis on market and the main deposit types, *Applied Earth Science*, Vol. 131/4, pp. 218-236, <https://doi.org/10.1080/25726838.2022.2102883>
- SKM and ETI (2010), Offshore Connection Project – State of the Art Offshore Network Technology Report, https://ukerc.rl.ac.uk/ETI/PUBLICATIONS/ESD_EN2001_5.pdf
- Snam (2021), Corinth pipeworks delivers first hydrogen-certified pipeline project for Snam's high pressure gas network in Italy, 3 June, https://www.snam.it/en/Media/Press-releases/2021/Snam_Corinth_Pipeworks.html
- Stangarone, T. (2021) South Korean efforts to transition to a hydrogen economy, *Clean Technologies and Environmental Policy*, Vol. 23, pp. 509-516, <https://doi.org/10.1007/s10098-020-01936-6>
- Strohm (2022), Strohm and Evonik to bring TCP with Carbon Fibre PA12 to green hydrogen market, 13 June, <https://strohm.eu/news/strohm-and-evonik-to-bring-tcp-with-carbon-fibre-pa12-to-green-hydrogen-market>
- The Maritime Executive (2022), LNG Carriers Continue to Lead Newbuilds with Further USD 2.6 billion in Orders, 6 September, <https://maritime-executive.com/article/lng-carriers-continue-to-lead-newbuilds-with-further-2-6b-in-orders>
- The White House (2022), The Biden-Harris Permitting Action Plan to rebuild America's infrastructure, accelerate the clean energy transition, revitalize communities and create jobs, <https://www.whitehouse.gov/wp-content/uploads/2022/05/Biden-Harris-Permitting-Action-Plan.pdf>
- Trupply (2022), Carbon Steel and Stainless Steel Welded and Seamless Pipe, <https://www.trupply.com/pages/metal-seamless-welded-pipes>
- UNCTAD (United Nations Conference on Trade and Development) (2021), Review of Maritime Transport 2021, <https://unctad.org/webflyer/review-maritime-transport-2021>
- UNCTAD (2020), Review of Maritime Transport 2020, <https://unctad.org/webflyer/review-maritime-transport-2020>
- UNEP (United Nations Environment Programme) (n.d.), The Global Programme for Sustainable Ship Recycling, <http://www.basel.int/Portals/4/Basel%20Convention/docs/pub/leaflets/leafShips.pdf>
- United Kingdom, BEIS (Department for Business, Energy & Industrial Strategy) (2022), Atmospheric implications of increased hydrogen use, https://assets.publishing.service.gov.uk/government/uploads/system/uploads/attachment_data/file/1067144/atmospheric-implications-of-increased-hydrogen-use.pdf
- United States, DOE (2022a), DOE proposes new efficiency standards for distribution transformers, 28 December, <https://www.energy.gov/articles/doe-proposes-new-efficiency-standards-distribution-transformers>

- United States, DOE (Department of Energy) (2022b), Electric Grid Supply Chain Review: Large Power Transformers and High Voltage Direct Current Systems, <https://www.energy.gov/sites/default/files/2022-02/Electric%20Grid%20Supply%20Chain%20Report%20-%20Final.pdf>
- United States, DOE (2022c), Carbon Capture, Transport, & Storage: Supply Chain Deep Dive Assessment, 24 February, <https://www.energy.gov/sites/default/files/2022-02/Carbon%20Capture%20Supply%20Chain%20Report%20-%20Final.pdf>
- United States, DOE (2021), Technical Support Document Energy Efficiency Program for Commercial and Industrial Equipment: Distribution Transformers, August, <https://downloads.regulations.gov/EERE-2019-BT-STD-0018-0022/content.pdf>
- US Permitting Council (United States Federal Permitting Improvement Steering Council), (2022), Federal Infrastructure Permitting Dashboard, <https://www.permits.performance.gov/projects>
- VesselFinder (2022), Vessels Database, <https://www.vesselfinder.com/vessels>
- VTG (n.d.a), 20' ISO Gas tank container, <https://www.vtg.com/20-iso-gas-tank-container-24800-liter>
- VTG (n.d.b), Cryogenic rail tank cars, <https://www.vtg.com/hiring/our-fleet/g92062d>
- Wu, W. et al. (2022), Optimization of long-distance and large-scale transmission of renewable hydrogen in China: Pipelines vs. UHV, International Journal of Hydrogen Energy, Vol. 47/58, pp. 24635-24650, <https://doi.org/10.1016/j.ijhydene.2021.10.066>
- Worzyk, T. (2009), Submarine Power Cables – Design, Installation, Repair, Environmental Aspects, Springer Science & Business Media, <https://doi.org/10.1007/978-3-642-01270-9>

Chapter 6. Policy priorities to address supply chain risks

Highlights

- Clean energy and technology supply chains are at the nexus of climate, energy and industrial policy, and so establishing them requires an all-of-government approach. As a supply chain is only as strong as its weakest link, we present a comprehensive risk assessment framework to assist policymakers. The focus is on key bottlenecks impeding the rollout of clean energy supply chains, as well as priority actions to enhance their security, resilience and sustainability.
- Any supply chain faces the risk of bottlenecks; for new clean technology supply chains, time is a critical factor. Project lead times are particularly long for enabling infrastructure for electricity, hydrogen, and CO₂ management, as well as for mines. It is therefore essential to reduce permitting times; mobilise investment and financing for key supply chain elements; develop skills in anticipation of future needs; and accelerate innovation in early-stage technologies.
- High geographical and market concentrations threaten clean energy technology supply security: today, the three largest producing countries hold 70-85% of global manufacturing capacity of mass-manufactured technologies like solar PV modules, wind, batteries and electrolyzers. The combined output from announced manufacturing projects for key clean energy technologies in China could potentially supply 60% of the global total in monetary terms, implying considerable net export potential. Together, the output from projects announced in the United States and the European Union is equivalent to two-thirds of combined market size implied by their announced climate pledges by 2030, with the US Inflation Reduction Act expected to prompt more project announcements.
- Boosting supply chain resilience is important, as market disruptions and input price fluctuations can have profound cost implications. Reducing and diversifying material inputs and designs are key primary measures to reduce exposure, along with building reparability into new production capacity concepts and strategic oversizing. Designing industrial strategies that foster domestic competitive advantages will also be important, as the relevance of energy costs does not diminish with the transition to clean energy. For example, some regional differences in renewable hydrogen production costs will persist, producing knock-on effects for the cost of derived products such as steel and ammonia.
- Environmental and social risks must be addressed to build sustainable supply chains. The most emission-intensive steps of clean technology supply chains are bulk and critical material production, followed by technology manufacturing. Policies need to focus on expanding lead markets for near zero emission materials and on scaling up minimum recycled content requirements; traceability standards; and environmental, social and governance regulations.

Designing policies for supply chains

Policies for clean energy and technology supply chains are at the intersection of climate, energy and industrial policy. Establishing secure, resilient and sustainable supply chains therefore requires a comprehensive and co-ordinated approach that takes account of the knock-on effects and interactions of the broader policy mix. Fallout from the Covid-19 pandemic and Russia's invasion of Ukraine have forced a global reckoning of how governments think about energy security, climate goals and supply chains. Today's crises are a reminder of the interconnectedness of our energy systems and their technology supply chains, and that our current reliance on fossil fuels is unsustainable. Yet this situation can – and must – be a catalyst for achieving a cleaner, more secure energy future.

The goal for all governments must be to ensure that supply chains are secure, resilient and sustainable while accelerating the deployment of clean energy technologies. Chapter 2 assessed in detail the vulnerabilities of selected clean energy supply chains that could compromise achievement of this goal, drawing particular attention to the risks associated with surging demand for critical minerals and reliance on supplies from a very small number of countries, leading to a new energy security paradigm. Policies must therefore be redesigned to address these vulnerabilities, taking care to avoid practices that may deter investment in – and limit diversification of – critical mineral resources, respecting international trade rules and norms, and working in a collaborative fashion for the good of everyone. This chapter considers how governments should go about designing policies on clean energy supply chains and sets out broad recommendations on prioritising action.

Applying a risk assessment framework

Understanding the risk profile of each element of the supply chain is a key step in determining where to focus efforts to enhance security, resilience and sustainability, and how to develop policies to address potential vulnerabilities. These profiles can look very different depending on the country, region and supply chain and will undoubtedly change over time as new technologies and materials emerge, and as technologies mature and markets develop.

Both governments and businesses can use a risk assessment framework to evaluate supply chain risks and vulnerabilities. The IEA has developed such a framework, first presented in the *Securing Clean Energy Technology Supply Chains* report, published in July 2022 (IEA, 2022a). For the purpose of this report, analysis has been significantly expanded to provide a more comprehensive risk assessment framework that analyses a range of vulnerabilities that may prevent energy and technology supply chains from being secure, resilient and sustainable while scaling up and developing at the pace required for climate objectives (Table 6.1). Two criteria are typically used in risk assessments, which each element can be tested against:

- **Likelihood:** How likely is it that a given clean energy or technology supply chain fails to expand at the pace required to meet climate objectives in a secure, resilient and sustainable way?
- **Impact:** What is the effect of failing to achieve security, resilience and sustainability while expanding a given clean energy or technology supply chain?

The framework is designed to be applied to current supply chain structures, with a view to assessing risks in the short to medium term at the global, national or regional level towards a given targeted clean energy transition if no action were to be taken. We have applied the framework here to analyses of the preceding chapters to assess potential risks for deployment delays, and failure to achieve security, resilience and sustainability from a global perspective. We focus on the gap between near-term prospects for scaling up clean energy and technology supply chains based on planned projects and the ambition required in the Net Zero Emissions by 2050 (NZE) Scenario.

Table 6.1 Supply chain risk assessment framework

Criterion	Description	How it is applied in <i>ETP-2023</i>
Accelerating clean energy transitions: What is the risk of a supply chain element failing to scale up at the pace required to meet the trajectory?		
Likelihood	Longer lead times and labour shortages increase the probability of not scaling up quickly enough. Technologies at earlier development stages are most at risk.	What are the lead times to develop additional mining, material production, manufacturing capacity and infrastructure?
Impact	The impact of failing to scale up will be lower if the investment gap between the expected throughput capacity and that required to match a targeted clean energy transition trajectory is relatively small.	What is the investment gap to match NZE Scenario needs in 2030?
Security: What is the risk of a supply chain element experiencing a supply disruption?		
Likelihood	The likelihood of a disruption increases with significant market concentration at the firm or geographic level. Exposure to geopolitical risks, such as trade restrictions, conflict or political instability will also increase the likelihood of disruption.	How concentrated is production geographically (at the country and region level)?
Impact	The impact of supply disruption can be reduced if there is enough redundancy or strategic over-sizing of supply capacity. Readily available substitutable technologies and materials that can be used relatively easily as alternatives can also reduce the impact of a supply disruption.	What is the utilisation rate of existing capacity? Can the materials or manufacturing processes be directly substituted with alternatives? How advanced are the alternatives (what is the TRL of alternative technologies or materials)?

Criterion	Description	How it is applied in <i>ETP-2023</i>
Resilience: What is the risk of a supply chain element not being able to respond quickly to a shock in the market?		
Likelihood	Longer lead times increase the probability of not being able to react to a market shock quickly enough.	What is the lead time to develop additional mining, material production, manufacturing capacity and infrastructure?
Impact	The impact of a sudden change in demand can be reduced if there is enough redundancy or strategic over-sizing of supply capacity. Readily available substitutable technologies and materials that can be used relatively easily as alternatives can also reduce the impact of a sudden demand change.	What is the utilisation rate of existing capacity? Can the materials or manufacturing processes be directly substituted with alternatives? How advanced are the alternatives (what is the TRL of alternative technologies or materials)?
Sustainability: What is the risk of a supply chain element not being able to operate within sustainable standards/not having a CO ₂ footprint compatible with stated goals?		
Likelihood	Exposure to environmental and social issues increases the likelihood of a supply chain element failing to meet environmental and social standards.	Focus on CO ₂ emissions: How emissions-intensive is the supply chain element?
Impact	The greater the relative importance of a given element in the functioning of its supply chain, the larger the impact of that element failing to comply with targeted social and environmental standards. The impact can also be reduced if there are alternative components, techniques and approaches that are less exposed to social and environmental issues and that can be implemented relatively easily.	Focus on CO ₂ emissions: What is the contribution of a given element to the total emissions of its supply chain?

Notes: NZE Scenario = Net Zero Emissions by 2050 Scenario; TRL = technology readiness level.

Our approach applies quantitative metrics when they are available, complemented by expert judgement, to assess likelihoods and impacts against each of the identified objectives to determine the degree of risk for each step in the supply chain, from resource extraction to material production, component and technology manufacturing, and installation and infrastructure construction, excluding operation. Supply chains were assessed independently of one another.

To represent risk magnitude in a risk matrix, several key indicators for likelihood and impact were chosen for each objective:

- **Accelerating deployment:** Expansion lead times (likelihood) and the investment gap between near-term plans and the targeted trajectory (impact).
- **Security:** Degree of regional concentration of supply (likelihood) and difficulty in switching to alternative technologies or materials (impact).

- **Resilience:** Expansion lead times (likelihood) and difficulty in switching to alternative technologies or materials (impact).
- **Sustainability:** CO₂ emissions intensity of activities in each supply chain step (likelihood) and contribution of each step to supply chain CO₂ emissions (impact).

We applied the risk assessment to the six energy and technology supply chains analysed in this report, namely those for low-emission electricity (solar photovoltaic [PV] and wind turbines); low-emission hydrogen (electrolysers and natural gas-based hydrogen production with carbon capture and storage [CCS]); low-emission synthetic hydrocarbon fuels (including direct air capture [DAC] and bioenergy with carbon capture [BECC]); electric vehicles (EVs); fuel cell trucks; and heat pumps. We also applied the risk assessment to the infrastructure underpinning these supply chains, including electricity networks, hydrogen transport and storage, and CO₂ management. The next section presents the results of this assessment, as well as an assessment of how the various risks and vulnerabilities can be reduced and recommendations for government policy prioritisation.

Policy approaches

It is the job of governments, in collaboration with industry and other stakeholders, to create conditions that encourage the development of clean technology supply chains. Governments need to develop a cohesive a policy approach concerning supply chains, comprising a set of measures targeting specific steps to address supply chain development barriers as part of a broader set of energy and climate policies to achieve net zero emissions. An extensive range of policy tools and measures, including various instruments for demand creation, innovation support and investment risk mitigation, have already been proven effective to stimulate clean technology and fuel markets. They now need to be applied to their supply chains.

There are a variety of ways in which governments can and do stimulate investment in clean technology supply chains. A mixture of technology-push policies that drive innovations to market (e.g. funding research, development and demonstration [RD&D] to reduce costs and risks) and market-pull policies that incentivise their use and stimulate economies of scale has generally proven to be the most cost-effective approach to deploy clean energy technologies (see Box 6.1). A range of market-pull policies can also be used to stimulate demand for clean energy technologies, products and services, facilitating their market uptake. Market deployment boosts economies of scale and learning-by-doing benefits, which improves the performance and reduces the cost of technologies, and builds investor confidence in the prospect of the technologies becoming competitive.

Both policy approaches can draw on a range of financial and regulatory instruments. Financial measures include energy and carbon taxes or penalties, as well as subsidies such as grants, tax credits, low-cost loans and feed-in tariffs. Regulatory measures include energy and emissions standards, restrictions on the use of certain technologies or fuels (e.g. a ban on oil-fired boilers), labelling/certification schemes, infrastructure planning and permitting, mandates (e.g. EV mandates and renewable portfolio standards), and direct government procurement, programmes and investment. Such policy instruments are central components of the climate and energy policy toolkit, and when combined with an industrial policy framework, can be applied to make supply chains more secure, resilient and sustainable.

The energy system transformation needed to achieve net zero emissions, involving a broad portfolio of technologies, will not happen at the necessary scale or speed without clearly formulated long-term government strategies, integrated into overall energy, climate and industrial policy and system planning, to guide and reduce the risks of investment decisions. Such long-term strategies need to be clear and incorporate near-term priorities, and their progress needs to be tracked against medium-term milestones to make them credible and to secure buy-in from businesses and investors.

Box 6.1 Case study: The solar PV supply chain in China

China dominates all segments of the solar PV supply chain – the result of more than two decades of government policies to develop a domestic industry. The initial impetus came from the 10th Five-Year Plan for 2001-2005, which set a vision for scaling up solar PV cell and module manufacturing. In its 11th Five-Year Plan (2006-2010), emphasis was on promoting domestic polysilicon and equipment manufacturing through grants, having identified reliance on imports of these materials as a hinderance to manufacturing PV cells.

Policy incentives initially targeted production. Grants, low-cost loans and funds from the Ministry of Science and Technology led to the establishment of several pioneering domestic manufacturers. The government also provided grants and tax incentives to import manufacturing equipment from Europe and the United States until Chinese companies were able to develop their own equipment technologies. In the absence of domestic demand, Chinese solar PV manufacturers initially sought to expand sales by exporting, improving their cost-competitiveness through economies of scale and integration of supply chain segments.

Policies later shifted to boosting domestic demand to support climate change mitigation efforts and give further impetus to domestic manufacturing, with China becoming the world's largest market in 2013. The first major subsidy programme supporting demand – the Golden Sun programme, launched in 2009 – provided

grants for nearly 6 000 MW of capacity using efficient and proven technologies. The government also introduced a feed-in tariff in 2011 and incentives for more efficient cell technology under the Top Runner Programme in 2015, which prompted Chinese manufacturers to shift their focus from multicrystalline to more efficient monocrystalline technology. Economies of scale and technological advances led to a drop in the average price of a PV module from around USD 4.5/watt (W) in 2005 to USD 1.5/W in 2011. In 2021, China announced plans to carry out demonstration programmes for distributed rooftop solar PV to incentivise counties to deploy rooftop systems.

Source: IEA (2022b).

Collaborating on supply chain development

Collaborative efforts focusing on innovation and investment will be central to the process of developing policies for secure, resilient and sustainable supply chains. Making net zero emissions a reality calls for a singular, unwavering focus from all governments in collaboration with businesses, investors and citizens, on all aspects of the clean energy transition. All stakeholders need to play their part in identifying and mapping out potential opportunities and vulnerabilities in supply chains, taking account of local circumstances and the specific characteristics of each sector and technology. This requires transparent public dialogue and consultations, developing programmes to boost skills in emerging industries and supporting the growth of new job opportunities in more sustainable economic activities.

It is important that governments work together in an effective and mutually beneficial manner to implement coherent measures that cross borders. Taking a regional or international approach can facilitate the identification of opportunities to develop common standards and approaches, as well as promote the sharing best practices and provide a platform for co-ordinating the development of clean technology supply chains (see Box 6.2). In particular, accelerating innovation, developing international standards and co-ordinating the scale-up of clean technologies and their associated supply chains must be done in a way that links national markets. International standards are important to support the development of markets for clean technologies and their associated supply chains, as they facilitate trade and technology transfer. They are needed to overcome technical barriers in international commerce caused by differences among technical regulations and standards developed separately by countries, national standards bodies and companies, and should be aligned with sustainability and climate goals. For instance, the application of traceability standards in clean energy is progressing, especially in advanced economies, but more attention is needed to ensure sustainable technology supply chains.

Co-operation must also recognise differences in the stages of development of different countries and the varying situations of different parts of society. For many wealthy countries, international co-operation is critical to achieve net zero emissions. For many emerging economies, building these supply chains in the absence of international assistance, including sustained and active technical co-operation and support, will be impossible.

Government collaboration and co-operation should focus particularly on creating rules-based, transparent markets for clean technology supply chains. International and multi-stakeholder co-operation can facilitate the transfer of knowledge with respect to emerging technologies and avoid bottlenecks in their supply chains when they reach the commercialisation stage. This is particularly important in the middle and later steps of the supply chain: for example, manufacturers must be ready to boost output if there are new innovations further up the supply chain, and demand signals need to be sent to stimulate consumer interest, such as for near zero emission steel, as new production technologies become available.

Box 6.2 Case study: Strategic partnerships in clean energy supply chains

Governments are already establishing strategic partnerships in the field of clean energy supply chains. For example, in May 2022, 13 nations agreed to the Indo-Pacific Economic Framework for Prosperity, including a focus on securing critical supply chains to ensure access to key raw and processed materials, semiconductors, critical minerals and clean energy technologies.

In the **European Union**, the Action Plan on Critical Raw Materials, launched in 2020, aims to reduce dependence on single supplier countries by developing strategic partnerships to diversify the supply of sustainable critical raw materials. Under this plan, the European Union signed an agreement with Canada and convened in February 2022 to further develop policies, including to secure financial support for critical mineral projects and develop environmental, social and governance (ESG) criteria and standards.

Zambia and the **Democratic Republic of Congo** signed a co-operation agreement in April 2022 to facilitate development of the battery supply chain for EVs. The two countries, both major producers of key critical minerals for EV batteries (cobalt and copper), established a Battery Council to oversee the new agreement. The agreement is expected to provide a framework for bilateral co-operation. In December 2022, the **United States** signed a memorandum of understanding with the two countries to aid this effort by providing technical assistance for the EV supply chain and is exploring financing and support mechanisms for investment.

Sources: EC (2020); United States, DOS (2022).

Prioritising policy action

Based on analysis in the previous chapters and results of the risk assessment framework (presented below), we have developed a set of policy recommendations that governments can use to prioritise action to lower the risk of and vulnerability to major supply disruptions, while accelerating clean energy technology deployment. The policy recommendations aim to equip policymakers with the tools necessary to accelerate clean energy transitions by anticipating and alleviating bottlenecks; secure supply chains through diversification; boost resilience by reducing input needs; and establish sustainable supply chains by addressing emissions and other harmful environmental and social effects. Table 6.2 summarises the recommendations and they are discussed in turn below. Real-world case studies showcase how governments are applying the recommended actions.

Table 6.2 Policy recommendations for secure, resilient and sustainable supply chains

	Key recommendations	
Accelerate the clean energy transition	Review permitting and approval processes [Case study: Box 6.5]	<ul style="list-style-type: none"> Establish clear permit approval timelines and requirements Create a “strategic project” designation for access to accelerated processes, such as a one-stop shop for permitting
	Prioritise and co-ordinate the rollout of enabling infrastructure [Case study: Box 6.6]	<ul style="list-style-type: none"> Draw up long-term plans for parallel development of clean electricity generation and network expansion requirements Plan and support industrial clusters Provide technical assistance to emerging economies
	Support recruitment, training and accreditation programmes [Case study: Box 6.7]	<ul style="list-style-type: none"> Provide funding for apprenticeship opportunities, or require them as part of public procurement tenders Harmonise accreditation standards
	Step up innovation programmes [Case study: Box 6.8]	<ul style="list-style-type: none"> Earmark funds to address specific supply chain gaps Facilitate communication with companies through partnerships, initiatives and joint ventures Improve access to low-cost financing for demonstration projects
Secure supply chains	Develop geological surveys for critical mineral resources	<ul style="list-style-type: none"> Support critical mineral mapping efforts Encourage collaboration and data-sharing
	Consider critical mineral stockpiles	<ul style="list-style-type: none"> Carefully design stockpiles to avoid exacerbating shortages
	Design industrial strategies to incentivise investment [Case study: Box 6.9]	<ul style="list-style-type: none"> Use tax incentives, early-mover grants and low-cost financing to reduce risks for capital-intensive projects Leverage funding from national development banks for grants, technical assistance, credit enhancements and loan guarantees
	Co-ordinate supply chain assessments	<ul style="list-style-type: none"> Create a new workstream under the Clean Energy Ministerial Provide guidance to companies to assess and manage supply chain risks (e.g. methodology, common definitions, indicators)

	Key recommendations	
Boost resilience	Review design and manufacturing regulations	<ul style="list-style-type: none"> Move from prescriptive to performance-based design standards
	Promote repairability and longer lifetimes [Case study: Box 6.11]	<ul style="list-style-type: none"> Establish requirements to build repairability into design stages Create remanufacturing and second-life application programmes
	Explore opportunities to repurpose infrastructure [Case study: Box 6.13]	<ul style="list-style-type: none"> Examine reuse of retired coal power plants and infrastructure Identify opportunities to repurpose pipelines and revise decommissioning requirements
	Leverage competitive advantages	<ul style="list-style-type: none"> Choose where to specialise based on geographic and workforce advantages
Establish sustainability	Increase material reuse, recyclability and recycling rates [Case study: Box 6.14]	<ul style="list-style-type: none"> Establish circularity roadmaps and material recovery targets Adopt product stewardship and extended producer responsibility policies
	Adopt standards for clean technologies and traceability [Case study: Box 6.15]	<ul style="list-style-type: none"> Develop taxonomies for low- and near zero emission products and materials Require the use of traceability standards in public procurement tenders
	Consider ESG regulations [Case study: Box 6.16]	<ul style="list-style-type: none"> Draw on the OECD's Due Diligence Guidance for Responsible Supply Chains
	Support near zero emission material production [Case study: Box 6.17]	<ul style="list-style-type: none"> Use public procurement for demand creation Create lifecycle-based emissions standards for final products Establish international sectoral agreements or clubs

Accelerating the clean energy transition

Achieving net zero emissions will require an unprecedented acceleration of global deployment of clean energy technologies and the facilities to support their supply chains. Rapid deployment of these technologies in the next decade is crucial: any delays will mean that reaching net zero by mid-century will become increasingly difficult (see Chapter 2). Ambitious government policies are needed to encourage both demand for clean energy and supply of the technologies and skills needed to produce it. Policies need to consider current and future bottlenecks involved in expanding clean energy and technology supply chains.

Our assessment of selected global supply chain risks shows that, among the different supply chains steps, infrastructure deployment to enable hydrogen production and CO₂ management is most at risk of falling short of the rate required in the NZE Scenario, owing to long lead times and large investment gaps. This is important because infrastructure affects the deployment of multiple supply chains, including, within the group studied in this report, electrolytic and natural gas-based hydrogen with CCS, fuel cell trucks, and low-emission synthetic hydrocarbon fuel production (Figure 6.1). Mining also presents a risk for supply chains that rely heavily on critical minerals (fuel cell trucks, electric cars, solar PV, wind and electrolytic hydrogen), while risks associated with manufacturing and installation mainly concern some large-scale, site-tailored technologies (natural gas-based hydrogen production with CCS, BECC, and syngas) that require substantial investments and involve long installation lead times.

Figure 6.1 Risks threatening acceleration of the global clean energy transition

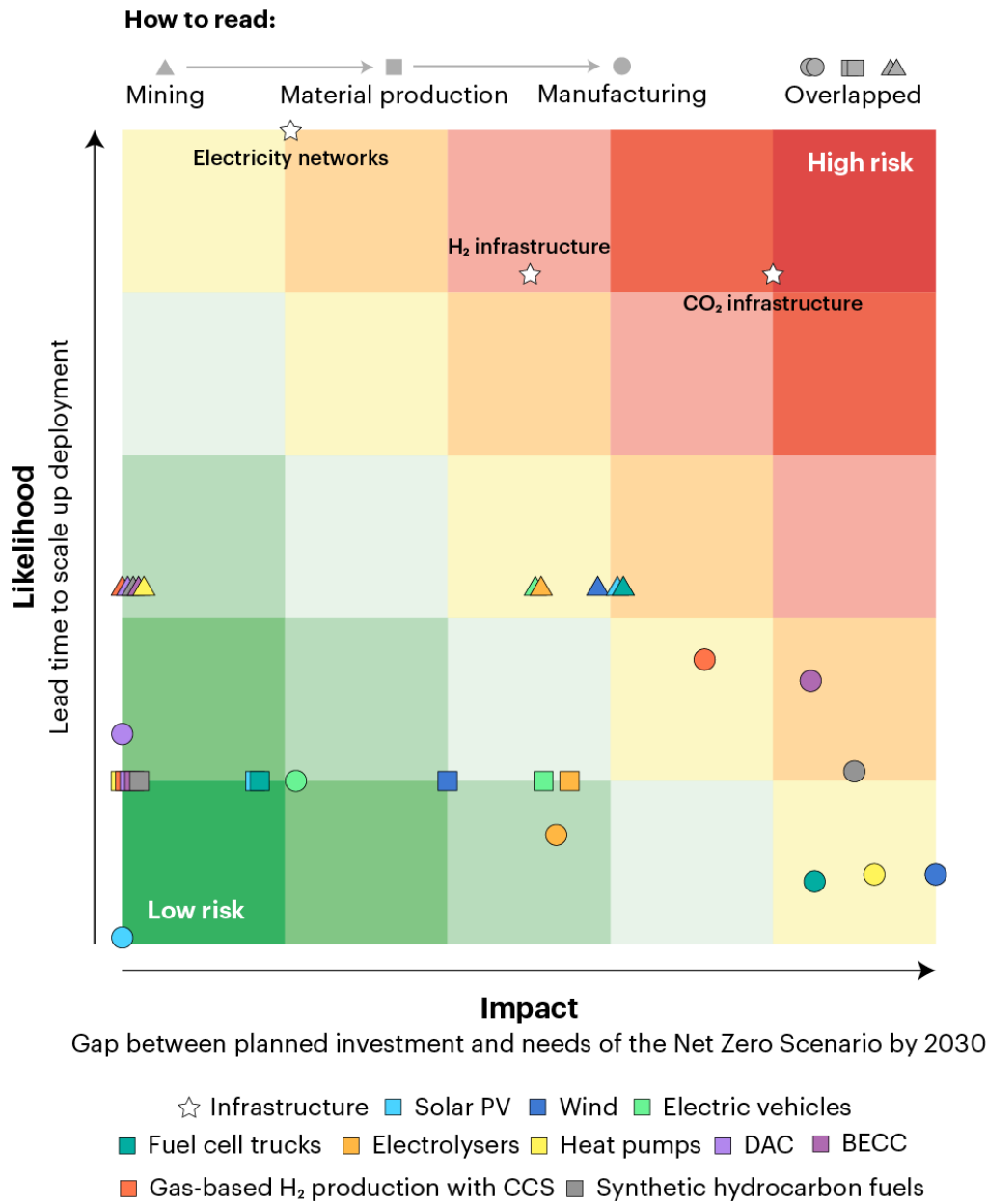

IEA. CC BY 4.0.

Notes: BECC = bioenergy with carbon capture; DAC = direct air capture. Supply disruption likelihood is based on lead times to deploy new facilities on a scale of 0 (shortest lead time, around 1 year) to 10 (longest lead time, around 10 years). When different facilities (e.g. for mineral refining and bulk material production) are involved at a given step of the value chain, the lead time corresponds to the maximum value. Impact is measured by the gap between current announced investment and that required to achieve projected NZE Scenario deployment in 2030 on a scale of 0 (lowest gap, around 0%) to 10 (highest gap, around 100%). For mining and processing, investment shortfalls in copper, cobalt, lithium and nickel were used to rate technologies. For electricity networks, the investment gap is the relative gap between the annual electricity network investment in 2030 in the NZE scenario and the average according to current policy announcements and commitments. Arrows indicate how individual points are connected within a supply chain (here with the example of gas-CCS H₂).

Sources: IEA analysis. For data sources and further background on the investment analysis see Figure 1.11, and on the lead times analysis see Figures 1.15 (mining) and 1.16 (material production, manufacturing and installation, infrastructure).

Along the clean energy and technology supply chains analysed, the deployment of enabling infrastructure is the element at most risk of falling short of the required NZE Scenario rate.

Strategic considerations

All supply chains are subject to the risk of bottlenecks emerging periodically as a result of temporary mismatch between supply and demand at a particular point along the chain. The global semiconductor shortage that emerged in 2020, which has caused enormous disruption to supply chains generally worldwide, including for clean energy technologies, is a prime example of such a bottleneck (see Box 6.3).

There are several potential causes of bottlenecks, including shortages of critical components or sub-components and labour, the unavailability of commercially proven technologies, logistical problems, unplanned factory closures and weather-related events, among many others. The duration of bottlenecks can vary from days to years. It can be hard to predict precisely when or where they may occur, but they can be anticipated and alleviated with appropriate business and government action.

One slightly less obvious solution to the problem of lengthy lead times for supply chains is to initiate project development earlier in anticipation of future demand increases. This can be facilitated by improved “signalling”, i.e. the use of more reliable, accurate and earlier demand signals such as corporate and government plans, strategies and forecasts, or by the creation of more favourable market conditions through risk-sharing arrangements. Improved signalling could also enable the early involvement of stakeholders in the project development process, a critical component of building public trust and social acceptance.

Government prioritisation of key technologies and supply chains is critical in this regard. Governments need to back up their climate ambitions with credible roadmaps and implementation plans, detailing how and when specific milestones are to be met. The greatest uncertainty for businesses and households is the extent of their country’s commitment to meet policy goals. If they do not have confidence in their country’s climate policies, they are likely to make investment and spending decisions based on much more conservative expectations.

We focus here on four strategic areas to address these risks: shortening project lead times, mobilising investment, hiring and upskilling workers, and boosting innovation to shorten the time it takes for key technologies to reach the market.

Box 6.3 Case study: Policy responses to the semiconductor shortage

The global semiconductor or “chip” shortage that emerged in 2020 has caused enormous disruption to supply chains generally worldwide. Even before 2020, difficulties in obtaining equipment to make older types of semiconductors had begun to emerge, in part due to surging demand as various industries shifted to more chip-intensive products. The Covid-19 pandemic reinforced these trends by

further boosting demand for products that require semiconductors of all types and by cutting supply volumes during lockdowns. Other events such as factory fires, winter storms and energy shortages also contributed.

In response, governments around the world have taken emergency measures to address immediate supply shortages. They have also taken the opportunity to examine their respective supply chains to identify vulnerabilities and propose longer-term policy solutions to prevent such shortages in the future.

In **Europe**, in February 2022 the European Commission proposed the European Chips Act to increase the region's resilience and reduce external supply dependence by boosting Europe's share of global semiconductor manufacturing to 20% by 2030 compared with just 10% today. The Act will be supported by more than EUR 43 billion in investment through 2030, of which around EUR 15 billion will be additional to existing funding, and a similar amount of private sector funding is being targeted. The Act makes use of a range of policy approaches: direct investment in new technologies; access to facilities for prototyping and piloting; certification to guarantee quality for critical applications; improved investment conditions in manufacturing facilities; access to equity financing for start-ups and small and medium-sized enterprises (SME); support for workforce development; and global partnerships with like-minded countries.

The **United States** conducted a comprehensive review of a number of critical supply chains, including for semiconductors in 2021, resulting in many recommendations to develop resilient and reliable semiconductor supply chains. They include pursuing a policy of “reshoring” by encouraging domestic manufacturing and RD&D, and “friend-shoring” by working collaboratively with like-minded economies to secure supply chains. A number of global semiconductor manufacturers have since announced plans to expand manufacturing capacity in the United States, including a USD 20-billion investment by Intel and a USD 17-billion investment by Samsung. To aid this effort, in August 2022 the Creating Helpful Incentives to Produce Semiconductors for America Act and the Science Act of 2022 were signed into law to promote domestic semiconductor manufacturing and research, and to accelerate the design, development, and manufacturability of next-generation microelectronics. The law includes federal incentives such as tax credits for manufacturing facilities and funding for workforce development.

In **Australia**, the government has launched a Modern Manufacturing Strategy, making AUD 1.5 billion in funding available over four years in response to Covid-19 related supply chain disruptions. Building resilience into supply chains of products critical to the national interest, including semiconductors, is a central component of the strategy, with AUD 107 million in grant funding allocated for supply chain resilience initiatives. The grant programme aims to help Australian businesses invest in new equipment, technology, skills and processes, including required raw

materials, intermediate materials and specialised manufacturing equipment. A specific goal is to increase Australia's share of the global semiconductor supply chain, building on existing strengths and areas of competitive advantage. The strategy also established the Office of Supply Chain Resilience.

Sources: EC (n.d.); The White House (2022a); Australia, Department of Industry, Science and Resources (2020).

Shortening lead times

Although minimising lead times to speed up deployment can reduce costs and increase the competitive advantage of projects, it is often difficult in mature sectors. The largest gains could be made by focusing on the supply chain elements with the longest lead times, such as exploration for new resources in mining, which can take decades. Risk-sharing arrangements between the public and private sectors can help reduce costs and accelerate this process, with funding of precompetitive exploration (carried out before a bidding process for exploration licences is launched) being particularly vital. Developing skills in this area can also accelerate exploration activities, as can using best practices in allocating licences and recouping inactive ones.

Focusing on elements common to several supply chains could also help cut lead times efficiently. For example, obtaining financing can cause delays in many cases, but can be addressed through capacity-building in the financial community, such as in multilateral development banks. Redirecting financing and encouraging lenders to prioritise projects that are compatible with net zero goals is essential.

Shortening the time needed to build new clean technology supply chain elements could also help reduce costs and boost investment, indirectly boosting deployment as well. Spending capital closer to the completion of a project saves on borrowing costs and raises investment returns. A project's construction costs can be reduced by around 2.5% if the construction window is shortened from three to two years at a 5% cost of capital, assuming evenly spread construction spending. For projects with higher financing costs such as those often seen in emerging economies, this impact is magnified. For example, for the same reduction in construction time, the cost is reduced by 7.1% with a 15% cost of capital. Reducing lead times also reduces the amount of time capital is locked up in each project, and hence increases the effective pool of capital available for projects to access. Conversely, anything that delays project timelines increases the cost of capital by raising uncertainty and risk, hence deterring investment.

Mobilising investment through policy

All governments would need to have consistent and focused policies to mobilise the scale of supply chain investment envisioned in the NZE Scenario. Global energy sector investment requirements more than double between 2021 and 2030, with most of the increase occurring in emerging markets and developing

economies (Figure 6.2). The bulk of this investment is needed for clean energy technologies. Given public funding constraints, the private sector would need to continue to provide most new investments. Enhanced collaboration among developers, investors, public financial institutions and governments could help mobilise private capital, which will be particularly important in the next few years as novel demonstration and infrastructure projects are launched.

Figure 6.2 Annual energy sector investments by regional grouping in the NZE Scenario

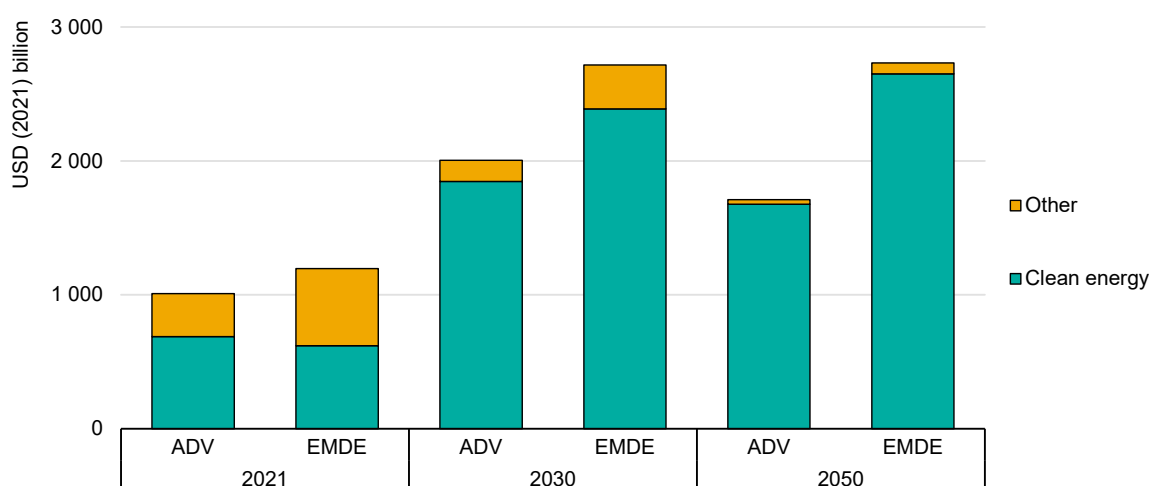

IEA. CC BY 4.0.

Notes: ADV = advanced economies; EMDE = emerging markets and developing economies; NZE Scenario = Net Zero Emissions by 2050 Scenario.

Source: IEA (2022c).

Clean energy investment needs nearly triple for advanced economies and nearly quadruple for emerging markets and developing economies by 2030 in the NZE Scenario.

It is crucial to align policy support for clean energy supply with demand to avoid supply chain imbalances and inefficiencies. Financing investments will require access to financial support mechanisms and low-cost financing such as blended-finance solutions, particularly in emerging economies. Central banks around the world have recently been raising interest rates in response to rising inflation, pushing up the cost of debt in energy-related sectors by over 30% from pre-pandemic levels (IEA, 2022c). Keeping financing costs low will be critical to accelerate energy transitions as the energy sector becomes more capital-intensive.

Accrediting training schemes to help alleviate skill gaps

Uncertainty about the pace of the clean energy transition also affects workforce training and upskilling. Workers are less likely to invest time or money to gain the

new skills necessary to work with clean technologies if they are uncertain about when or the extent to which those skills will be needed. Investment in workforce training programmes is essential to establish a qualified workforce and make energy transitions “people-centred” to ensure that the benefits and costs involved are distributed fairly and in a way that protects society’s most vulnerable (IEA, 2021a). The clean energy sector already faces difficulties hiring personnel to keep pace with demand, and labour shortages have held back investment in some countries (see Chapter 2).

To avoid bottlenecks, governments can play an important part in workforce training, education and reskilling programmes as demand for clean energy jobs increases, especially for technologies with long lead times. They have a moral obligation to ensure a just energy transition for all and support workers in sectors where employment may be reduced or lost.⁶⁸ Several cases of harmful consequences of a failure to set out clear policy goals have already emerged. For example, the UK heat pump sector has cited ambiguous government signals about future policy support as a deterrent to investing in worker training, resulting in a shortage of qualified installers as demand increases (Norman and Regan, 2022; Nesta, 2022).

In response to the growing need for new skills, several countries and companies have begun to establish new accreditations – evaluations of conformity with recognised standards performed by independent third-party organisations – for training in the clean energy sector (see Table 6.3). Today, accreditations for energy supply chains are primarily available for installation (mainly for solar PV and wind systems, and for heat pumps in some countries), and in some cases for operations and maintenance. Accreditations in raw material extraction and manufacturing are rare, as both typically rely on in-house worker training tailored to a specific product.

Well-organised and accredited training programmes can translate into savings for clean energy companies of costs associated with creating or finding appropriate training options, which could help reduce technology costs. Certification can ensure high-quality products and installation. Poor installation of clean energy technologies poses a significant risk for emerging industries, as it can damage the reputation of products and undermine their uptake. Industry-wide safety standards and certifications can also facilitate widespread adoption of best practices.

⁶⁸ Set up by the IEA in January 2021, the Global Commission on People-Centred Clean Energy Transitions has formulated a set of actionable recommendations to influence the clean energy policies and programmes of governments, funders, investors and international organisations to maximise their benefits to people and ensure the overall success of clean energy transitions (<https://www.iea.org/programmes/our-inclusive-energy-future#recommendations>).

Table 6.3 Accreditation requirements for clean energy sector workers by technology in selected countries, 2022

	United States	United Kingdom	China	India
Solar PV	Requirements vary by state. About one-third have solar-specific certifications.	Although not legally mandated, installers must be certified by the MCS for the solar system to benefit from government incentives.	Mechanical and electrical equipment installers are required to have corresponding qualifications.	Requirements vary by state; some jurisdictions require licenced electrical or general contractors.
Wind	No licence or standard certification is required to become a wind turbine technician, but the US DOE maintains a list of wind energy education and training programmes.	Employers may require engagement in or certification from one of several government-sponsored training schemes.	No specific certification is required to work on wind turbines, though some employees may need to have state construction engineering certificates.	No specific certification is required, though employers may demand engineering degrees or training certificates.
EVs	Certification from the National Institute for Automotive Service Excellence is usually required by larger repair shops or dealerships.	The automotive industry is generally unregulated, so no certification is required to service vehicles.	Personnel performing maintenance on EV battery systems must hold a general electrician certificate and all technicians must undergo training to gain general certification.	There is no single certification to work on EVs. Mechanics often begin their careers as apprentices.
Heat pumps	HVAC technician licence and electrician licence requirements vary by state, but all technicians who work with equipment containing refrigerants must be certified.	Installers must hold a certification in plumbing, HVAC, gas or similar to be certified by the MCS and qualify for government incentives.	A voluntary industry Qualification Certificate System is in place for personnel working with refrigerants.	The servicing sector remains largely informal, and there is no universal certification system for HVAC technicians.

Notes: PV = photovoltaic; EV = electric vehicle; HVAC = heating, ventilation and air conditioning; MCS = microgeneration certification scheme.

Sources: RSI (2022); MCS (2022); China, NEA (2022); India, MNRE (2019); d'Estries (2021); United States, DOE (2022a); National Careers Service (2022); Chinalawinfo (2022); India, National Qualifications Register (2021), United States, BLS (2022); IMI (2018); CAAM (2021); The Hindu (2022); IEA (2022d), Global EV Outlook 2022; UNEP (2015); Bhasin, Gorthi and Chaturvedi (2020).

Reducing the time to get new technologies to market

Reducing the length of time from a technology's conception until it is commercialised and considered "material in the market" (i.e. well established commercially) is critical. A range of measures can help meet this objective.

Collaboration among firms, even in highly competitive industries, can improve innovation efficiency. For example, in the steel sector, Baowu Steel launched the

Global Low-carbon Metallurgical Alliance in 2021 to accelerate the pace of learning regarding novel technologies. To date, the majority of progress in key near zero emission iron and steel projects has been in Europe and North America. These global collaborative initiatives can help reduce time to market and build the market faster.

Reducing the time to market for a particular technology can also be achieved by increasing spending on innovation (including by targeting innovation at areas of the supply chain most in need) and improving the efficiency of innovation. Areas with potential spillovers between technologies, where breakthroughs could be relevant for multiple technology areas (such as material innovation useful for both electrolysers and batteries) should be high-priority targets.

Public sector energy research and development (R&D) spending is currently dominated by China (30% of total spending) and advanced economies (66% of the total) (Figure 6.3). The energy sector made up 5-10% of total public R&D spending (excluding prospecting for resources) between 2011 and 2020 in countries for which data are available (OECD, 2022).

Figure 6.3 Public energy R&D by region and corporate energy R&D by technology

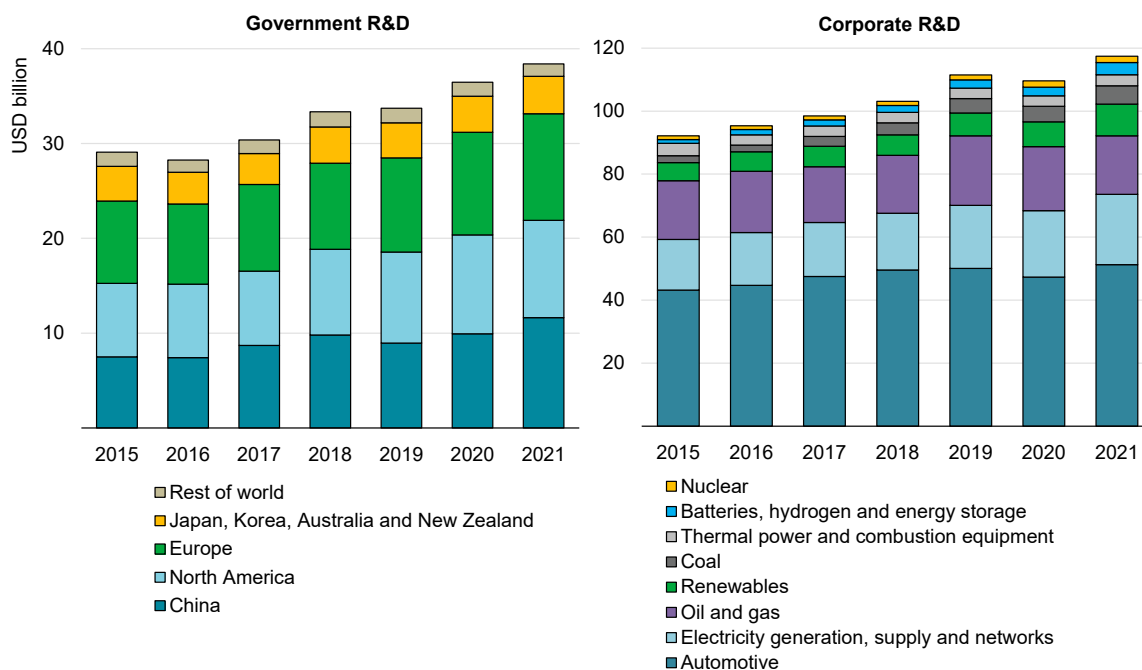

IEA. CC BY 4.0.

Note: R&D = research and development.
Source: IEA (2022c).

Public sector energy R&D spending is currently dominated by China (30%) and advanced economies (66%).

Innovation, particularly in resource extraction, material processing and end-of-life stages to reduce mineral and material dependency, will play a vital role in alleviating future bottlenecks for clean technology supply chains. Massive growth in the need for critical minerals to manufacture key components in clean technology supply chains in the NZE Scenario will put pressure on existing links. More and more companies are therefore searching for untapped deposits in remote corners of the world, often in places with limited infrastructure, and lead times to build new capacity are long. Policy support and co-ordination in this regard are crucial. Innovation policies can help reduce mineral dependency by enabling the elaboration of methods to recycle raw materials and the development of low-cost alternative materials to manufacture clean energy technologies and deliver the same service, allowing investors to better adapt to volatile prices and uncertain demand by increasing the rate of extraction and lowering costs.

Policy recommendations

We focus below on several specific measures targeted at clean energy and technology supply chains that can be particularly effective in reducing bottlenecks as clean energy transitions progress, namely strategic reviews of permitting and approval processes to improve efficiency and reduce lead times; prioritising and co-ordinating the rollout of enabling infrastructure; supporting recruitment and training programmes; and enhancing innovation funding and programmes to target key challenges within energy supply chains.

Box 6.4 Case study: Strategies for clean energy supply chains in the United States and Europe

In February 2022, the **United States** Department of Energy (DOE) released a comprehensive report outlining how it plans to increase the security and resilience of domestic clean energy supply chains. Based on detailed assessments of 13 energy technologies and components and a review of the supply chains of critical products, including semiconductor manufacturing and advanced packaging, large-capacity batteries and critical minerals and materials, the strategy outlines actions to achieve seven key objectives:

- Increase critical material availability
- Expand domestic manufacturing capabilities
- Invest in and support the formation of diverse, reliable and socially responsible foreign supply chains
- Increase clean energy adoption and deployment
- Improve end-of-life energy-related waste management
- Attract and support a skilled workforce for the clean energy transition

- Enhance supply chain knowledge and decision making

The strategy takes a “whole of government” approach and recommends more than 60 specific policy actions across the federal government, including loans, government procurement, regulations and workforce development. It further recommends actions that the US Congress should take, including introducing tax incentives, procurement mandates, funding for recruitment and training, increased RD&D and trade policies.

In **Europe**, in May 2022 the European Commission presented its REPowerEU Plan in response to the global energy market disruptions brought on by Russia’s invasion of Ukraine. Measures in the plan, which aims to increase energy savings, diversify energy supplies and accelerate renewable energy deployment, include:

- Forging new energy partnerships with reliable suppliers, including future co-operation on renewables and low-carbon gases.
- Rapidly rolling out solar and wind energy projects combined with hydrogen production.
- Introducing new legislation and recommendations for faster permitting of renewable energy systems, especially in areas of low environmental risk.
- Investing in an integrated and adapted gas and electricity infrastructure network.
- Ensuring industry access to critical raw materials by identifying mineral resources and supporting critical raw material projects of strategic European interest while ensuring a high level of environmental protection, including through projects that promote a circular economy and resource efficiency.
- Establishing a comprehensive regulatory framework for hydrogen.

Sources: United States, DOE (2022b); EC (2022a).

Review permitting and approval processes

Permitting and approval processes are a key step in the development of a clean energy project, whether it involves deploying a specific energy technology or developing a new mine, processing facility or factory for producing or assembling materials or components. As the risk assessment shows, establishing supporting infrastructure for clean technologies, such as for hydrogen and CO₂ management and for mining projects, suffers from particularly long lead times (see Figure 6.1). It can potentially take decades for these new projects to come on line due to a variety of factors, including permitting and litigation delays. Involving stakeholders early on in these processes can help ensure that environmental impacts are adequately considered, the public is consulted and contingency plans are put in place, helping to mitigate any potential delays. Improving the efficiency of the permitting process to allow for the timely and transparent approval of permits for

new projects could help accelerate the deployment of clean technology supply chains and ensure public engagement, without undermining the need to meet environmental standards.

To this end, governments can establish clear and direct permit approval timelines and requirements, with flexibility built into regulations to give projects the opportunity to apply for application extensions. This can enable developers to better plan project timelines and reduce regulatory bottlenecks. While the length of permitting procedures will inevitably vary by country, governments should provide a clear indication of how long they are likely to take. One approach to improve the efficiency of the process is to create a “strategic project designation” in permitting regulations that allows clean energy and related supply chain projects access to accelerated processes and resources without compromising environmental, labour or sustainability standards (see Box 6.5). Governments would need to determine which projects fall into this category, based on whether they are in the public interest and advance energy and climate policy goals. This could include establishing a one-stop shop, whereby a single regulatory body or a cross-government co-ordinating group is responsible for co-ordinating the permitting process when it involves different government agencies. This body could also offer guidance and support on how to navigate permitting frameworks if a proposed project involves multiple jurisdictions.

It is important that governments provide regulatory bodies with the necessary resources and capacity to oversee and undertake permit approvals. This includes ensuring adequate funding, technical expertise and staffing to review and process permit applications, as well as establishing channels of communication across government agencies to ensure smooth co-ordination.

Box 6.5 Case study: Identifying strategic projects in the European Union

The EU Trans-European Networks for Energy (TEN-E) policy aims to promote linkages in energy infrastructure among member states. It identifies projects of common interest (PCI) that will have significant impact and provide EU-wide benefits. Importantly, the PCI designation also gives projects a priority status and access to accelerated planning and streamlined permitting arrangements to facilitate faster commissioning. Specifically, PCI status:

- Designates a national authority responsible for facilitating and co-ordinating permitting for the project.
- Requires EU countries to take measures to streamline environmental assessment procedures to reduce regulatory bottlenecks.
- Sets a maximum time limit of 3.5 years to process a project’s permit application.

Granting similar strategic status to new mines and processing or manufacturing facilities for clean energy projects, as well as to the infrastructure needed to support these projects (e.g. electricity transmission and distribution, EV charging, hydrogen and carbon capture, utilisation and storage [CCUS]) could enable governments to reduce project lead times while still ensuring environmental criteria are met.

Prioritise and co-ordinate the rollout of enabling infrastructure

Accelerating the deployment of clean energy technologies requires parallel expansion of the infrastructure required to supply to end users the energy these technologies produce. This includes electricity grids, EV charging infrastructure, hydrogen and CO₂ pipeline networks, and CO₂ storage facilities, as well as infrastructure to support increased circularity, such as networks and facilities for collecting, sorting, and reusing and recycling materials at the end of their useful lives. Early government action is essential to ensure that buildouts and upgrades of this enabling infrastructure keep pace with technology deployment to prevent bottlenecks (see Chapter 5).

For electricity systems, governments have a crucial role in drawing up long-term visions and plans to ensure that electricity network expansion and modernisation advance in parallel with the deployment of clean electricity generating technologies and rising demand, including from emerging end uses such as EV charging (see Box 6.6). Transmission capacity and generator connection bottlenecks are major obstacles in expanding the role of clean electricity. Governments and regulators need to examine current transmission planning policies and, if necessary, revise them in light of the time required for permitting. Regulators can convene system operators to discuss multiregional planning approaches that indicate where additional transmission expansion is needed, and they can help co-ordinate the permitting process for large transmission projects.

Government support and co-ordination can help ensure that enabling infrastructure is built out in a timely way in the places where it is needed. This is particularly important for hydrogen and CCUS infrastructure, given the amount needed (see Chapter 5), and planning industrial clusters can help facilitate this. Public funding, such as grants, loan support and direct equity stakes, can help strengthen the business case for infrastructure projects, which usually involve very large upfront investments (IEA, 2020a). Governments can also help organise technical workshops in partnership with industry to improve understanding of the extent and timing of infrastructure requirements as clean energy deployment progresses, and they can conduct public outreach campaigns to allay concerns about the social and environmental effects of infrastructure projects.

Infrastructure banks could be an important avenue through which to mobilise and target investment in clean energy infrastructure, while also providing technical assistance on financial aspects and helping streamline approvals. For example, the European Investment Fund has allocated EUR 400-600 million annually over the next seven years to infrastructure projects through its Climate & Infrastructure Funds, with a focus on climate action and environmental sustainability (EIF, 2021). In emerging economies, attracting investment in infrastructure projects is likely to be particularly difficult, primarily because of the smaller market size, lack of technical capacity in government and a higher cost of capital. The governments of advanced economies should provide international assistance in the form of technical support for policy development and concessional financing to catalyse private investments.

Box 6.6 Case study: A one-stop shop for EV charging support in the United States

The United States aims to expand its national EV charging network to 500 000 chargers by 2030 – around four times the current number. The federal government has allocated funding of USD 7.5 billion to support this goal, two-thirds for states to fund charging stations along highway corridors. It has also announced a number of measures, including the creation of a joint office run by the DOE and the Department of Transportation. The Joint Office of Energy and Transportation will work closely with state governments, industry and other stakeholders to meet the national goal, acting as a one-stop shop for resources on EV charging and related topics. Initially, work will focus on providing technical support to states to deploy EV charging infrastructure strategically by:

- Providing data and tools, including installed chargers and designated corridors.
- Addressing gaps in existing datasets.
- Facilitating connections among state governments and experts.
- Providing guidance to state governments on federal programmes and regulations related to EV charging infrastructure.

Source: The White House (2022b).

Support recruitment, training and accreditation programmes

Clean energy transitions must be people-centred and inclusive to ensure equitable and just outcomes and build public support. Governments have a responsibility to manage the impacts of clean energy transitions, including reinforcing efforts to cultivate a skilled workforce for emerging industries and helping workers previously employed in the fossil energy sector transition to new fields. Likewise,

it is important to protect communities directly affected by new mines, processing and production facilities, and other related industrial projects.

There is a growing need to recruit and train workers for all segments of clean energy and technology supply chains, including mining specialists, plant technicians, engineers, researchers, administration staff, and tradespeople such as electricians, plumbers and construction workers. In addition, the need for qualified trainers is rising as workforce requirements expand. For example, a future hydrogen economy will require specialised trainers to protect hydrogen workers and consumers from safety risks. A dearth of qualified trainers is already proving problematic in the offshore wind sector, with many industry participants in Europe asserting that increasing the stock of qualified instructors is a top policy priority (ETIPWind, 2013).

Offering government support for apprenticeship programmes is one way to boost the availability of skilled workers for these roles. Although apprentice wages are often very low, employers in emerging clean energy sectors may still be unable to afford to take them on (Branford and Roberts, 2022). When necessary, offering direct financial assistance to employers or including a certain number of apprentices as a requirement in public procurement tenders could improve workforce capacity and support just transitions. Government authorities could also organise workshops and training events in conjunction with industry to identify opportunities to transfer skills and could subsidise programmes to help workers in fossil fuel sectors acquire skills for other sectors, including clean energy. For some activities, such as the mining of minerals, the skills required are similar to those needed in coalmining and in oil and gas production (see Box 6.7).

The United Kingdom's North Sea Transition Deal (NSTD), an agreement between the country's government and its offshore oil and gas industry, is a model for how governments can enable a more efficient and just transition. NSTD initiatives include the development of an energy apprenticeship programme that integrates the currently scattered apprenticeship programmes, as well as stocktaking of existing graduate-level training frameworks to facilitate collaboration between industry and the training sector (United Kingdom, BEIS, 2021).

Accreditation can be important to increase the size of the workforce and strengthen skills by reducing redundant training, clarifying what new workers need to learn and incentivising training bodies to improve the quality of their services. Used wisely, an accreditation system can attract workers to the clean energy sector by providing a clear pathway to employment, and can also ensure the quality of new supply projects and improve productivity. However, accreditation could actually lead to hiring bottlenecks if qualifications are too difficult to attain or too few accredited training schemes are available. International harmonisation of standards would help facilitate the free movement of personnel across national borders when necessary. This is especially relevant for the solar and wind

industries, in which most workers are involved in installation and therefore move on to new projects several times a year, sometimes in different countries.

Governments need to work closely with local communities directly affected by new mines, facilities and other projects related to clean energy to understand their concerns and needs. This might involve the establishment of an investment or revitalisation fund for projects that could be particularly beneficial for local communities.

Box 6.7 Case study: Enhancing transferable skills in Alberta

As part of its minerals strategy, the provincial government of Alberta in Canada has made developing a skilled workforce one of its guiding principles in expanding the critical mineral mining sector. The government is supporting the retraining of coal industry workers for employment in other sectors, including mineral mining. It offers dedicated funding and programmes such as the Tuition Voucher scheme, which provides financial assistance to help coal workers access post-secondary education to train for a new career. The government has also put in place a labour and talent strategy to increase work-integrated learning possibilities, expand apprenticeship opportunities and enhance connections between post-secondary education and industry.

Source: Alberta, Ministry of Energy (2021).

Step up innovation programmes

Innovation at different steps in clean energy and technology supply chains is critical to speed up deployment by reducing bottlenecks, time to market and lead times. Key areas where government support for innovation is needed at the four steps in supply chain stages include:

- Mineral extraction: Increased automation, heavy machinery operating on cleaner fuels, efficient desalination facilities to extract minerals from less concentrated ores, increased use of recycled water and digital techniques to identify optimal sites for mineral extraction.
- Material production: Near zero emission methods to produce both critical and bulk materials, production methods that reduce mineral or material waste, and the development of cost-effective alternative materials with greater efficiency (e.g. bioplastics and lightweight materials).
- Technology and product design and manufacturing: New designs that use less material or use smaller amounts of critical materials, designs that facilitate end-of-life recycling, manufacturing techniques with less material waste and zero emissions manufacturing methods.

- Reuse and recycling: Repurposing of existing infrastructure, improved methods for end-of-life material separation and recovery, first-of-a-kind recycling techniques in critical mineral and plastic sectors lacking well-established techniques, recycling techniques with a smaller carbon footprint.

Governments should identify technological supply chain gaps, establish a strategic plan for key technologies and earmark funds to finance their development in the four innovation areas over a specific time frame to bring them to market in a timely way. For example, innovation to support material production is under way to address the anticipated shortfall of iridium for hydrogen electrolyzers.

The DOE issued a USD 122-million grant to develop a Catalyst Discovery Engine that tests novel catalysts that could replace expensive, rare materials such as iridium. The machine analyses catalyst materials up to 10 000 times faster than existing methods and succeeded in developing dozens of viable non-iridium electrolyzers (Hydrogen Tech World, 2022). With respect to technological design, Kawasaki Heavy Industries is supplying the major German electric power company RWE with the latest L30A gas turbine, which can run 100% on hydrogen, 100% natural gas or a mixture of the two. Not only can it be retrofitted to existing natural gas infrastructure, but the gas turbine also enhances the life of the combustor and significantly reduces nitrogen oxide emissions by controlling flame propagation.

International co-ordination of innovation efforts and knowledge-sharing is also essential to maximise the efficient use of resources within the short time frames required by the NZE Scenario. International collaboration is vital to establish bilateral trade and make the technologies affordable for import countries. It also attracts foreign investment to export countries to reduce mineral dependency. Project developers could finance their activities through the strategic use of multiple innovation funds to bring a clean energy technology supply chain to commercialisation. Obtaining necessary funds across related technology areas would reduce time to market, make use of shared infrastructure and enable developers to capitalise on synergies.

Global initiatives such as Mission Innovation provide a platform for governments to join efforts to share RD&D findings in critical innovation areas. At the regional level, the EU Strategic Energy Technology (SET) Plan better co-ordinates national plans. Similarly, Japan's Asia Energy Transition Initiative (AETI) launched in 2021 provides approximately USD 15 billion for technological innovation and commercialisation along with USD 10 billion for renewables, liquified natural gas (LNG) and energy efficiency projects to support the energy transition in Asian countries (Japan, METI, 2021).

Co-ordination within the private sector across various supply chain stages is also important. For example, heat pump manufacturers should be aware of the innovation gains offered by certain refrigerants so they are ready to ramp up production capacity when new refrigerants reach the market. Governments can

increase dialogue through partnerships, strategic initiatives, joint ventures that combine public and private financing, and knowledge-sharing platforms. Open-access publishing of government-supported innovation research through knowledge-sharing requirements could promote co-ordination and innovation. Streamlining funding application processes, for instance by establishing centralised platforms that provide access to multiple government funding programmes, could help reduce the administrative burden for technology developers.

Support for innovation in clean energy and technology supply chains will need to be a key component of the broader step increase in public RD&D funding essential for clean energy transitions. Past innovation experience has demonstrated the benefits of appropriate targeting and co-ordination. For instance, for many years the Japanese government has supported research into the use of liquefied hydrogen as a transport fuel through the New Energy and Industrial Technology Development Organization (NEDO), which is responsible for public energy RD&D. Stable NEDO funding for this activity, which did not overlap with private sector efforts, was a crucial element in the successful commercialisation of the fuel in Japan.

We estimate that at least USD 90 billion in public funding (in real 2021 dollars) will need to be mobilised by 2026 to support completion of a portfolio of demonstration projects in critical areas to be on track for net zero emissions by 2050 (IEA, 2022e). While the budgets required are large, there are historical precedents for the rapid scale-up of energy innovation efforts, notably after the first oil shocks of 1973-1974, when IEA member countries collectively more than doubled their spending on non-fossil energy R&D by 1980. To address particularly challenging emissions reductions, technologies related to hydrogen, CCUS, electrification and bioenergy are most in need of demonstration, but they represent only about 25% of global public clean energy RD&D spending funding today. In September 2022, the IEA released its new Clean Energy Demonstration Projects Database, which maps major demonstration projects and could help with prioritisation of funds across the range of technology areas critical to achieve net zero emissions.

There are signs that much-needed increases in public funding of innovation could materialise. In the United States, the 2021 Bipartisan Infrastructure Law and the 2020 Energy Act together provide USD 62 billion of funding for major new clean energy demonstration and deployment programmes, more than tripling total spending and significantly expanding the overall RD&D budget (United States, DOE, 2022c). A significant share is expected to go to demonstration projects. Furthermore, at the Global Clean Energy Action Forum in the United States in September 2022, more than a dozen countries announced USD 94 billion for clean energy demonstration projects – exceeding the USD 90 billion in public funding called for by the IEA and the United States (United States, DOE, 2022d).

Government support for RD&D needs to be tailored in a way that helps leverage private sector contributions. Of the USD 117 billion in energy RD&D spent by listed companies in 2021, around 60% went to the automotive and oil and gas sectors and

around 9% was allocated to renewables (IEA, 2022c). Strategic government financing mechanisms could help increase private sector RD&D in other critical sectors (see Box 6.8). It is estimated that approximately 50% of the total capital cost of low-emission energy demonstration projects could be obtained from the private sector.

For large-scale demonstration projects, measures are needed to improve access to low-cost financing, such as credit enhancement (provisions used by a borrower to reduce debt by improving creditworthiness), risk-sharing schemes and in-kind advisory support. Demand-pull measures such as public procurement or private sector buying pools for clean technologies and products can also provide market confidence to strengthen the business case for innovation. Governments can also support clean energy start-ups through various mechanisms, including grants through prizes and calls for projects, loans and loan guarantees, incubators, and public investments in venture capital funds (IEA, 2022f). Infrastructure banks could be a useful model to administer and co-ordinate financing in support of private sector clean technology innovation. For example, the European Investment Fund under the European Investment Bank has channelled over EUR 1 billion to climate and environment venture capital and private equity funds since 2006 (EIF, 2022).

Box 6.8 Case study: Financing innovation in the European Union

The European Union has established several funds and instruments to leverage private investment in first-of-a-kind clean energy demonstration projects:

- The Innovation Fund, financed from Emission Trading System revenues, leverages private financing for large projects covering an entire supply chain as well as small-scale projects focusing on emerging greenhouse gas (GHG) reduction technologies through grants in multiple rounds. It aims to support commercial demonstration of nascent technologies by introducing industrial solutions into European countries to decarbonise them and support their transition to climate neutrality. By financing up to 60% of relevant costs for ten years after a project enters into operation, the Innovation Fund reduces investor risk. A third round of funding announced in July 2022 involves EU investment of over EUR 1.8 billion in 17 large-scale innovative projects. One is a hydrogen-based iron and steelmaking project involving an electric arc furnace in Sweden, using pyrolysis and photoelectrocatalytic hydrogen technologies.
- For early-stage technologies, the European Commission funds research projects under the Horizon Europe programme through grants, prizes and procurement. The current 2021-2027 programme has a budget of EUR 95.5 billion, of which around EUR 15.1 billion is earmarked for climate, energy and mobility projects, including low-carbon aircrafts, railways, road and maritime transport, as well as low-carbon steelmaking. Pillar II supports R&I

partnerships for clean energy technologies such as the Clean Hydrogen Partnership for renewable hydrogen production, storage and distribution. Pillar III oversees the deployment of industrial applications and technologies. Under the Horizon Europe programme, the European Commission established the European Innovation Council, which primarily provides grants and investments for individual SMEs and start-ups.

- Rules governing state aid allow for member states to invest directly in clean energy technologies when designated “important projects of common European interest” – ambitious cross-border breakthrough innovation and infrastructure projects that can contribute significantly to the achievement of EU strategies, including the European Green Deal. New rules that came into effect at the beginning of 2022 set the criteria for the European Commission to assess member state support to projects that overcome market failures and enable breakthrough innovation in key sectors and technologies and infrastructure investments.
- Additionally, the European Union facilitates dialogue and offers in-house advisory services through programmes such as the InvestEU Fund, which is expected to mobilise more than EUR 372 billion of public and private investment. Potential project applicants can ask the Advisory Hub of the InvestEU Fund for financial advice for projects backed by InvestEU or other sources. InvestEU also manages the EU-Catalyst partnership, which aims to mobilise up to EUR 820 million in funding during 2022-2026 to commercialise technologies for clean hydrogen, sustainable aviation fuels, DAC and long-duration energy storage.

Sources: EC (2021a); EC (2021b); ERA Portal Austria (2022).

Securing supply chains

A high degree of supply chain concentration – the extent to which market shares are concentrated among a small number of production facilities, firms, countries or regions – carries major risks for the security of supply of clean energy technologies. Concentration at any point along the supply chain makes the entire chain vulnerable to incidents, be they related to an individual country’s policy choices, natural disasters, technical failures or company decisions (Table 6.4). Persistent interruptions along clean energy supply chains can lead to bottlenecks and drive up the prices of intermediate and final products, delaying energy transitions, raising the cost of meeting net zero goals and leading to a less equitable transition (Figure 6.4).

Today, there is a significant degree of concentration of facilities, firms and countries across several clean technology supply chains (see Chapter 2). Many of the raw and intermediate materials and components that comprise clean energy

supply chains are produced in a small number of countries or regions, with the leading producer sometimes holding a very large share of the global market for certain inputs. Medium-term prospects for geographic diversity vary according to the stage of the supply chain and type of input, with concentration likely to worsen in some cases and improve in others (see Chapters 3-5). In some cases, supplies are also concentrated among a small number of companies, carrying a risk of excessive market power and higher prices. Overreliance on individual production or processing facilities and specific technologies also carries supply chain risks, reducing resilience to shocks (see next section).

Table 6.4 Components of supply chain concentration

Type of concentration	Description	Associated risks potentially causing supply chain disruption
Jurisdictional concentration	Extent to which production is concentrated in a single jurisdiction	Domestic policy changes Geopolitical events
Geographic concentration	Extent to which production is concentrated in a single geographic area	Natural hazards such as earthquakes and fires, and extreme weather events such as drought and flooding Technical failures of electricity grids, gas networks or other infrastructure
Facility concentration	Extent to which production is concentrated in a single facility	Risks cited above Onsite equipment failure
Market concentration	Extent to which production is concentrated in a single company	Risk of collusion, price-fixing and dumping
Technology concentration	Extent to which global production is centred on a single technology	All abovementioned risks would be amplified, especially material supply risks Intellectual property rights could slow technology transfer

Security risks cut across all steps of clean technology supply chains that are heavily reliant on core technologies, components or materials for which manufacturing, mining or processing is highly concentrated, such as the supply chains for solar PV, electric vehicles and wind systems (Figure 6.4). In the case of solar PV, the supply chain is highly concentrated in China, and alternative module technologies (such as thin films) and components (such as perovskite instead of polysilicon) are still immature. In the case of EV battery and wind supply chains, alternative battery chemistries and permanent magnet technologies are also far from commercialisation at present. While the manufacturing of these technologies is also highly concentrated, risks can be mitigated by the availability of spare manufacturing capacity when utilisation rates are low, as is the case for anode, cathode, battery, and PV module manufacturing. For large-scale site-tailored systems for which installation is also currently concentrated in a handful of regions, risk is mitigated by the fact that most of them rely on components and parts that are more generic and easily substituted.

Figure 6.4 Risks to the energy security of global clean energy supply chains

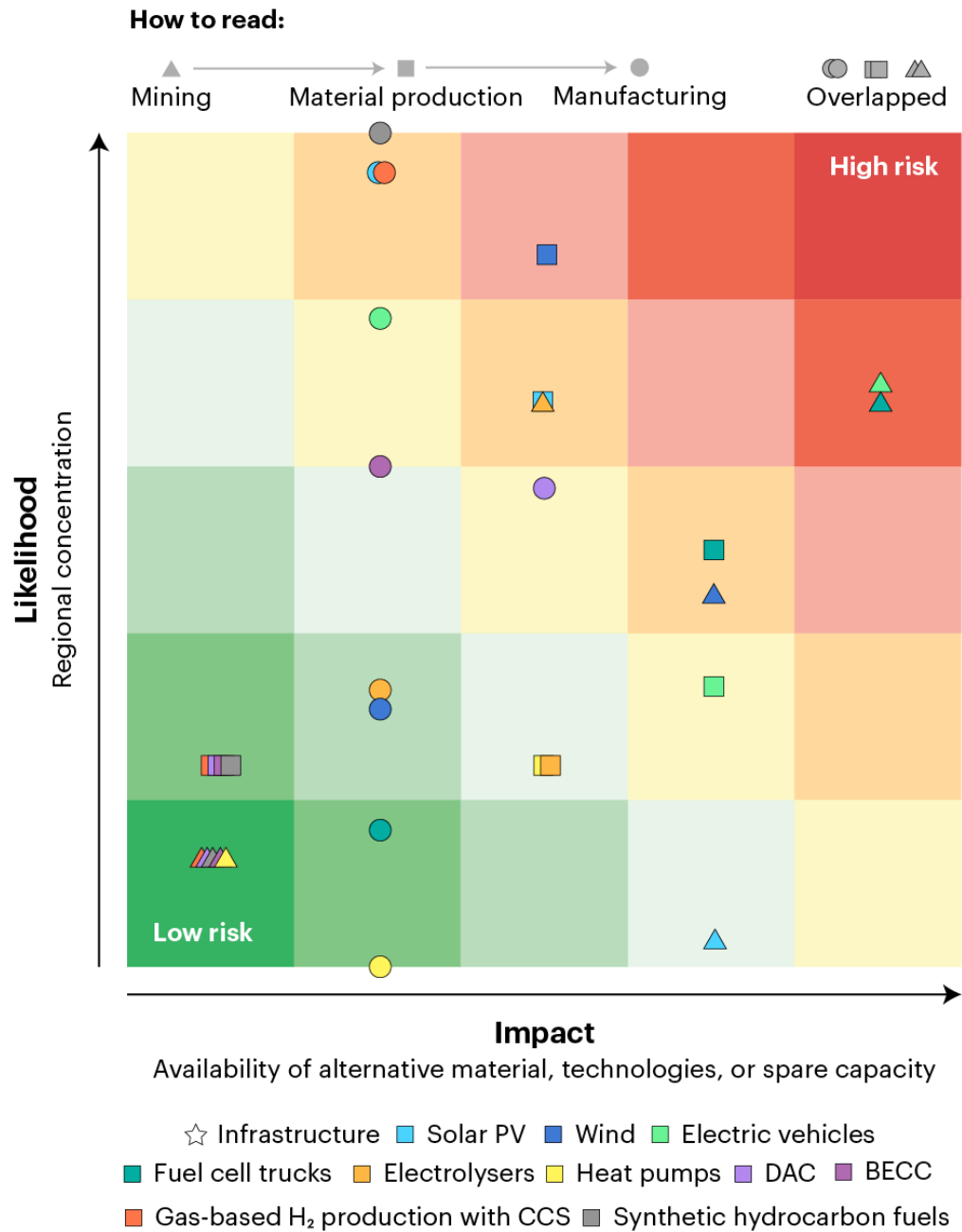

IEA. CC BY 4.0.

Notes: BECC = bioenergy with carbon capture; DAC = direct air capture. The likelihood of energy security risks is based on regional concentration (measured by the share of the largest mining, manufacturing or installation region in global supply) on a scale of 0 (smallest share of top region: around 40%) to 10 (largest share of top region: 100%). When a step involves different components or technologies, the rating is based on the most concentrated element. For gas-CCS H₂, DAC, BECC and synfuels, concentration relates to the location of the plants. Impact is measured by the availability of alternative materials, processing/ manufacturing technologies, or spare capacity (using the average utilisation rate of existing capacity), evaluated on a scale of 1 to 5, with 1 corresponding to readily available and 5 to no availability. Arrows indicate how individual points are connected within a supply chain (here with the example of electric cars).

Sources: IEA analysis. For data sources and further background on the regional concentration analysis see Figures 2.2 (mining), 2.3 (mineral refining), 2.5 (bulk material production), 2.6 (manufacturing) and 2.7 (installation and infrastructure).

Security risks cut across all steps of clean energy supply chains that are heavily reliant on a core technology, material or component for which supply is highly concentrated.

Strategic considerations

Geographic concentration and market concentration – and policies to address them – are inherently interlinked. Governments cannot practically seek to control all dimensions of supply chain concentration. In particular, the absence of minerals within a country's borders limits the government's ability to reduce its reliance on imports. Governments should seek to harmonise their industrial strategies with their energy and climate policies, taking account of the constraints and incentives facing producers, manufacturers and financiers.

Geographic concentration and industrial strategy

The preceding chapters of this report outline in detail the current state of geographic concentration for key components of clean technology supply chains. Mining is often the focus of discussion around geographic concentration in clean technology supply chains, partly because it is linked to natural resource endowment. For the mining of key critical materials – copper, lithium, nickel and cobalt – the top three countries account for around 45-95% of global output today, with the largest producer country accounting for just over 70% (Figure 6.5). For material production, the degree of geographic concentration is somewhat lower, mainly due to the presence of mature markets for both inputs and outputs. For the manufacturing of key clean mass-manufactured technologies – solar PV (modules), wind (nacelles), batteries (for EVs) and electrolysers – the largest three countries account for 70-85% of global manufacturing capacity, with the largest single producer accounting for up to around 70%.

Figure 6.5 Geographic concentration for key critical minerals, material production and manufacturing operations for clean energy technologies

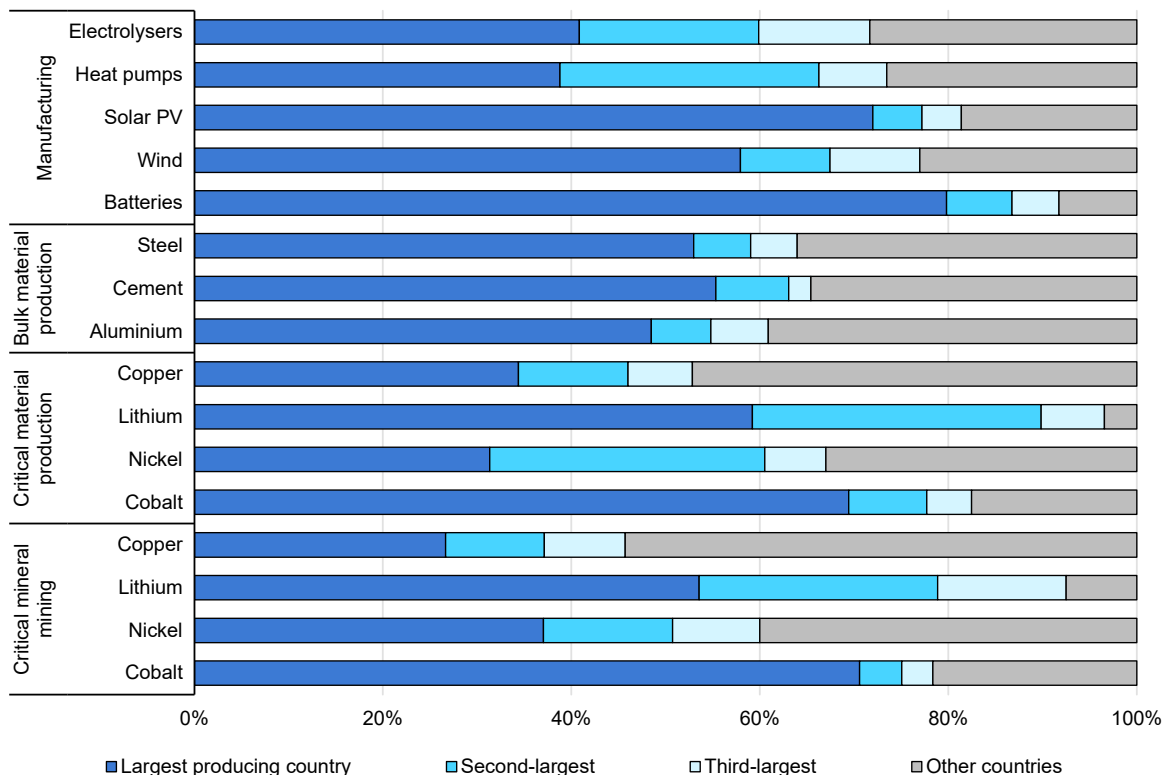

Notes: “Wind” corresponds to nacelle manufacturing. “Solar PV” corresponds to module manufacturing. “Batteries” corresponds to electric vehicle batteries.

Sources: Wood Mackenzie (2022); BloombergNEF (2020); BloombergNEF (2021); USGS (2022); WorldSteel (2022); S&P Global (2022a); World Bureau of Metal Statistics (2022).

The top three producing countries account for more than half of global output for most components and processing steps of clean energy technology supply chains.

Many countries and companies are already acting, aiming to cement their place in the new energy economy – one that is on track to deliver net zero emissions for the energy system. The pipeline of announced projects for mass manufacturing of clean energy technologies paints a mixed picture, but a distinctly positive one for some technologies at the global level. This is particularly true for solar PV, for which announced manufacturing capacity for finished modules – and their main components – already exceeds NZE Scenario requirements for 2030 (Figure 6.6). For others, announced manufacturing capacity exceeds the level required for deployment under announced government targets, as described by the Announced Pledges Scenario (APS).

Figure 6.6 Announced project throughput and deployment for key clean energy technologies in the APS and the NZE Scenario

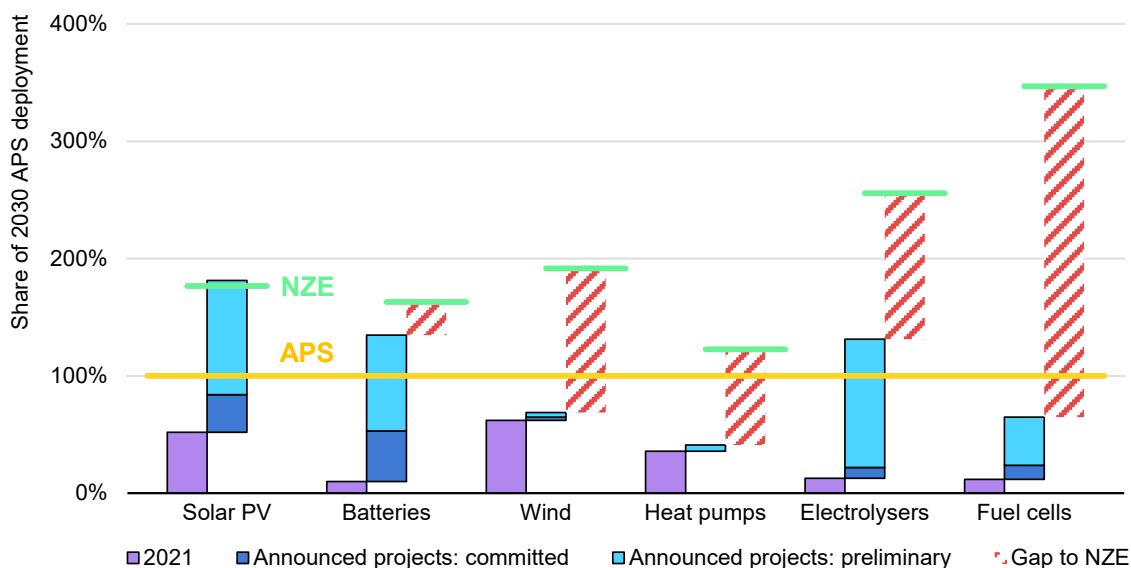

IEA. CC BY 4.0.

Notes: PV = photovoltaic; APS = Announced Pledges Scenario; NZE = Net Zero Emissions by 2050 Scenario. Announced projects for expanding capacity or building new facilities include projects that are at different stages of development, with some already under construction (committed) and others not yet at the final investment decision stage (preliminary). Deployment and throughput are expressed in physical units, normalised to APS 2030 deployment levels. Solar PV refers to module manufacturing capacity. Batteries refers to EV batteries. Wind figures are calculated using an average of the capacity ratings for blades, nacelles and towers, both for onshore and offshore installations. Heat pumps refer to output capacities of equipment used primarily for heating.

Announced manufacturing capacity can meet ambitious climate goals by 2030, but investment is firm for only around 10-40% of announced projects globally.

However, two aspects of these announced projects need to be scrutinised, aside from the significant gaps that remain for wind, electrolysers, heat pumps and fuel cells. First, the pipeline of announced projects is constantly evolving. For many projects that have been announced, there is a significant degree of uncertainty as to whether, where and when the necessary investments will actually take place. For example, only less than 10% of the 91 GW of announced electrolyser manufacturing capacity has reached final investment decision or is under construction; for batteries the figure is 35% and for wind, 40%. Conversely, further capacity announcements are likely to materialise before 2030, particularly for technologies for which manufacturing plants have short lead times, provided market and policy signals are consistent and clear. It is likely that final investment decisions as well as further project announcements will benefit from clear policy signals.

Second, while the global manufacturing gap (or lack thereof) is a relevant metric, the currently high degree of regional concentration in clean energy technology manufacturing capacity – notably in China – does not change substantially

according to existing announcements. China accounts for 85% of announced manufacturing capacity for solar PV, 75% for wind, 70% for batteries and 25% for electrolysers.

Due to uncertainties about future economic and policy developments, it is difficult to predict the future location of manufacturing plants beyond the time frame of projects under development or at the planning stage. Clean energy technology products themselves and their components can all be traded between regions on competitive international markets. Unlike mining or extraction of fossil fuels, their main inputs – materials, labour and energy – are either mobile or can be locally sourced. Given these characteristics, focusing on supporting the scale-up of domestic manufacturing capacity for clean energy technologies is an important industrial policy opportunity to enable participation in the new energy economy under governments' net zero pledges. Governments are therefore increasingly focusing their industrial strategies on these supply chain steps.

Looking at future domestic demand for clean technologies is a good starting point for governments examining the extent to which their industrial strategies can alleviate risks related to high geographic concentration while tapping into the opportunities of the new energy economy. Building up domestic clean energy technology manufacturing is a key opportunity to diversify supply chains, as well as boost economic growth. Local markets are often attractive to suppliers, given the lower transportation and administrative costs associated with delivering products to buyers. Furthermore, governments looking to stimulate a domestic manufacturing industry often have some degree of control over demand for clean energy technologies, as they usually fit within the remit of other areas of public policy (e.g. incentives for purchasing EVs). For countries seeking to secure or improve their export position, the demand of other countries (and overall global demand) should also be considered.

Since the APS reflects governments' actual policies and pledges as of late 2022, it is the most relevant lens for examining some of the potential scope of governments' industrial strategies, which are likely to be developed on the basis of these pledges. The combined global market for key mass-manufactured clean technologies – solar PV equipment, batteries, wind systems, heat pumps, electrolysers and fuel cells – reaches USD 650 billion per year by 2030 in the APS (Figure 6.7). Domestic demand in China, the European Union, the United States and India account for nearly three-quarters of the global market for key clean technologies by 2030 in the APS. The remaining countries of the Asia Pacific region account for a further 10%.

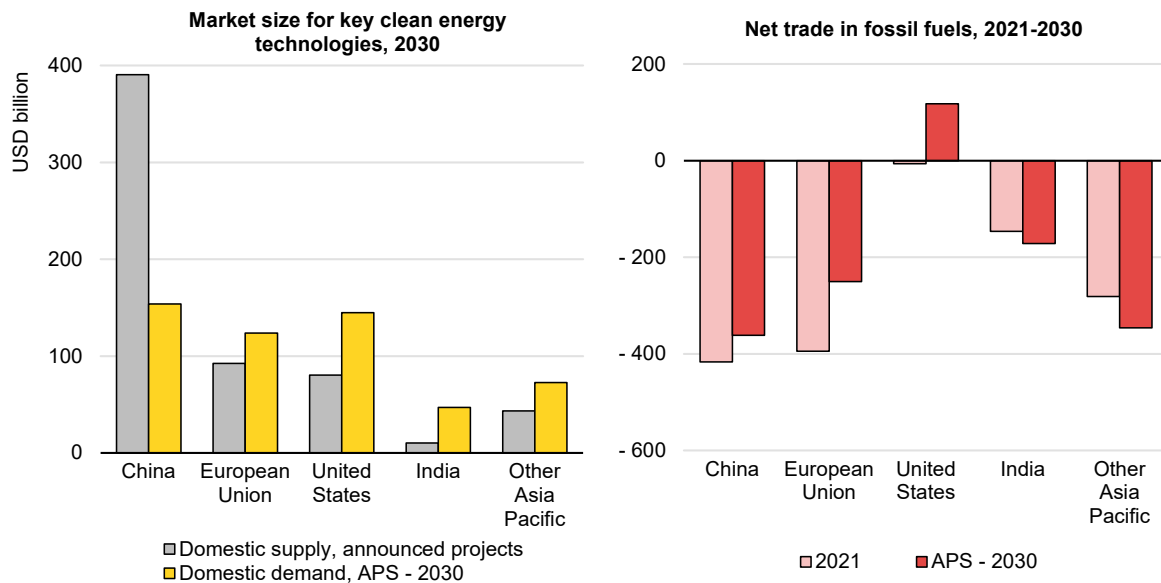
Figure 6.7 Market size for key clean energy technologies and net fossil fuel trade in the APS

IEA. CC BY 4.0.

Notes: Key clean energy technologies include solar PV systems, batteries, wind systems, heat pumps, electrolyzers and fuel cells. Market size is calculated based on module or unit price, excluding installation and construction costs. All market sizes and revenues are expressed in undiscounted 2021 US dollars.

Clean technology deployment helps reduce fossil fuel import bills in many regions; stimulating domestic manufacturing can be an important industrial opportunity.

If all announced projects for manufacturing these technologies come to fruition, the market value of their outputs would be around USD 650 billion per year in 2030, very similar to the market size of global demand in the APS for the technologies in aggregate. For individual technologies, however, there are significant disparities. For solar PV modules, announced projects are set to deliver USD 100 billion per year of output globally, compared with the APS market size of around USD 55 billion in 2030, constituting a USD 45 -billion manufacturing surplus relative to deployment according to countries' net zero pledges. Similarly, surpluses are projected for batteries (USD 90 billion) and electrolyzers (just under USD 10 billion). These surpluses imply that without a further increase in climate ambition, some of these projects could operate at very low utilisation rates, compromising their commercial viability. Conversely, announced projects for wind (nacelles, blades and towers), heat pumps and fuel cells fall short of the global market size in the APS by USD 140 billion combined, indicating a demand gap that could be filled by new project announcements.

Surpluses and deficits between the projected output of announced projects and APS demand also exist at the country level, implying potentially stark differences in the balance of trade between countries. China appears well positioned to capture USD 390 billion, or 60% of the outputs of announced manufacturing

capacity in monetary terms. Around 60% of this output (USD 240 billion per year) would be destined for export, on a net basis. Together, the United States and the European Union are set to capture USD 170 billion in 2030, while their domestic markets are projected to grow to nearly USD 270 billion in the APS, implying potential net import needs of around USD 100 billion if no additional capacity is forthcoming. The US Inflation Reduction Act may substantially change this picture, however, and is likely to reduce US net import requirements or even lead to net export opportunities across these clean energy supply chains.

Increasing domestic manufacturing is not risk-free. In the short term, measures to reduce geographic concentration and enhance domestic supplies have the potential to increase costs. Historical examples include India's policy to indigenise manufacturing of equipment during the 1970s, which made many businesses buy domestically produced equipment that was uncompetitive (Business Standard, 2021). More recently, import tariffs on solar PV cells and modules introduced in the United States to promote domestic manufacturing drove up costs, resulting in lost opportunities for employment, investment and deployment as the tariffs hindered potential further growth (SEIA, 2019).

Governments need to carefully balance the benefits of enhanced energy security with potential economic costs. Two important economic benefits are fossil fuel import savings (for net-importing countries) and new or expanded employment opportunities.

Global fossil fuel trade today is dominated by just a few major producing countries and regions, with a large number of countries being dependant on imports from these regions to meet domestic demand. Current policies and pledges, if fully implemented, would lead to lower fossil fuel import shares in domestic energy consumption in many major importing countries, replaced mainly by domestic production of renewable electricity and other low-emission fuels. In the APS, net imports of coal, oil and gas combined would decline by USD 145 billion, or 40%, between 2021 and 2030 in the European Union, and by USD 55 billion, or 15%, in China. The United States would increase its fossil fuel exports moderately under the same projections. In emerging and developing countries such as India, fossil fuel imports would increase slightly to satisfy rapidly growing demand, although fossil fuel shares in domestic energy consumption would still generally decline.

One of the key incentives for governments to cultivate domestic manufacturing capacity is job creation. The clean energy transition has contributed to a surge in energy sector employment (+25% globally since 2019), with clean energy now representing more than 50% of the global energy workforce. In the United States, for instance, clean energy jobs rose by nearly 150 000 in 2021, boosting energy sector employment 3% (United States, DOE, 2021; 2022e). The majority of employment in clean energy is associated with building new clean energy projects

and installing equipment, with clean energy manufacturing making up roughly 20% of the clean energy workforce (Figure 6.8). Today, this employment is overwhelmingly concentrated in China for solar PV, wind, heat pumps and electric vehicles. Shifting manufacturing hubs for these four key technologies would influence where new manufacturing jobs are created. In the APS, clean energy manufacturing jobs more than double from 6 million today to nearly 14 million by 2030, with over 50% of these jobs tied to the four key technologies.

Figure 6.8 Employment in clean energy technology manufacturing by region

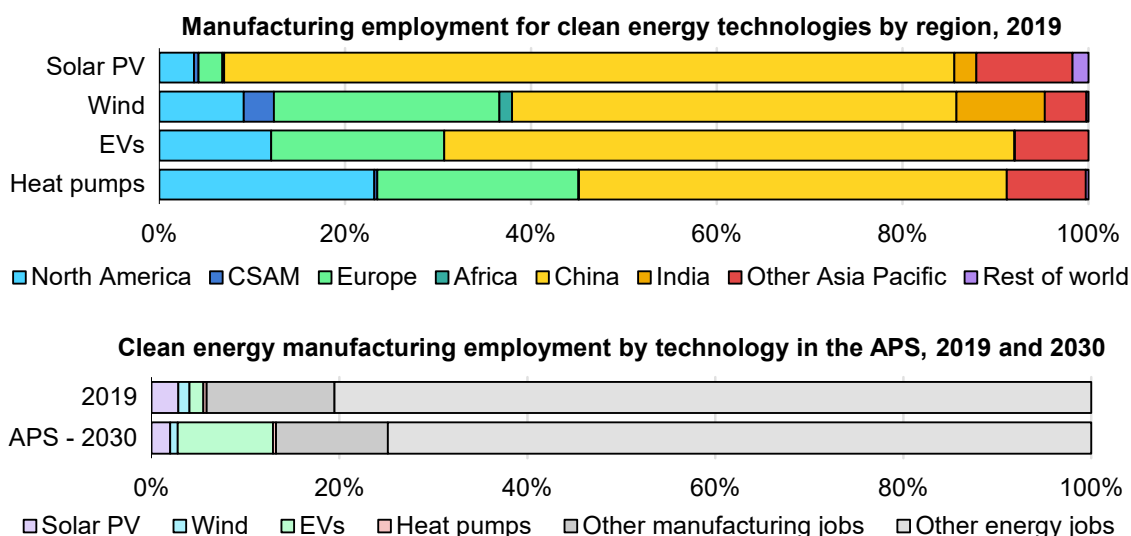

IEA. CC BY 4.0.

Notes: CSAM = Central and South America; EV = electric vehicle. "Other energy jobs" includes clean energy-related employment in construction, utilities, professional and scientific activities, wholesale markets, and transport for all clean energy technologies.

Energy sector employment for key clean technologies grows markedly in the APS, with the EV share increasing the most.

The number of workers needed at new manufacturing facilities depends heavily on prevailing wages in the region and the level of automation. Today, a large, fully integrated solar PV facility in China employs around 1 000-1 100 people per GW of capacity manufactured. However, equipping new facilities with the latest automation technologies means they will have significantly lower job intensity than those installed a decade ago, and smaller plants in countries with cheaper labour can require up to 60% more employees (IEA, 2022b).

New manufacturing capacity will have to be added for most of these technologies, but for EVs, many existing vehicle production facilities may simply retool their existing production. These new plants could be more automated so that the number of workers assembling vehicles would be fewer, but manufacturing batteries onsite would increase the total number of workers at these facilities in

most regions. As all manufacturing operations will experience efficiency gains and increased automation in the future, cost efficiencies need to be balanced against labour objectives (i.e. better wages and benefits, enhanced job security, and improved safety, representation and inclusion). The presence and strength of labour unions will also play a crucial role in shaping domestic clean energy supply chains.

Market concentration and corporate strategy

If unchecked, a high degree of market concentration – overreliance on a small number of companies for the supply of a given good – can lead to supply chain fragility. Firms look to maximise returns to shareholders, but large market shares can be a concern for policymakers on competition grounds. Firms' corporate strategies in the context of clean energy and technology supply chains can therefore be relevant to policymakers.

In mature, competitive industries, market concentration tends to be lower because the ability of firms to maintain a structural technological advantage dissipates over time. In the steel, cement and aluminium industries, the largest single producers account for 6-11% of global production, with the top five producers accounting for 18-38% combined (Figure 6.9). For emerging technologies, the opposite tends to be true, especially for those that have not yet achieved commercial-scale deployment. The leading manufacturers of plants for DAC, BECC, low-emission synthetic hydrocarbon fuel production and gas-based hydrogen production with CCS hold at least 30% of global production capacity, with concentration particularly high in the case of DAC and low-emission synthetic hydrocarbon fuels. In fact, there are only three commercial manufacturers of DAC plants globally, with the leader covering around 75% of global operating capacity, while there is only one manufacturer of synthesis plants.

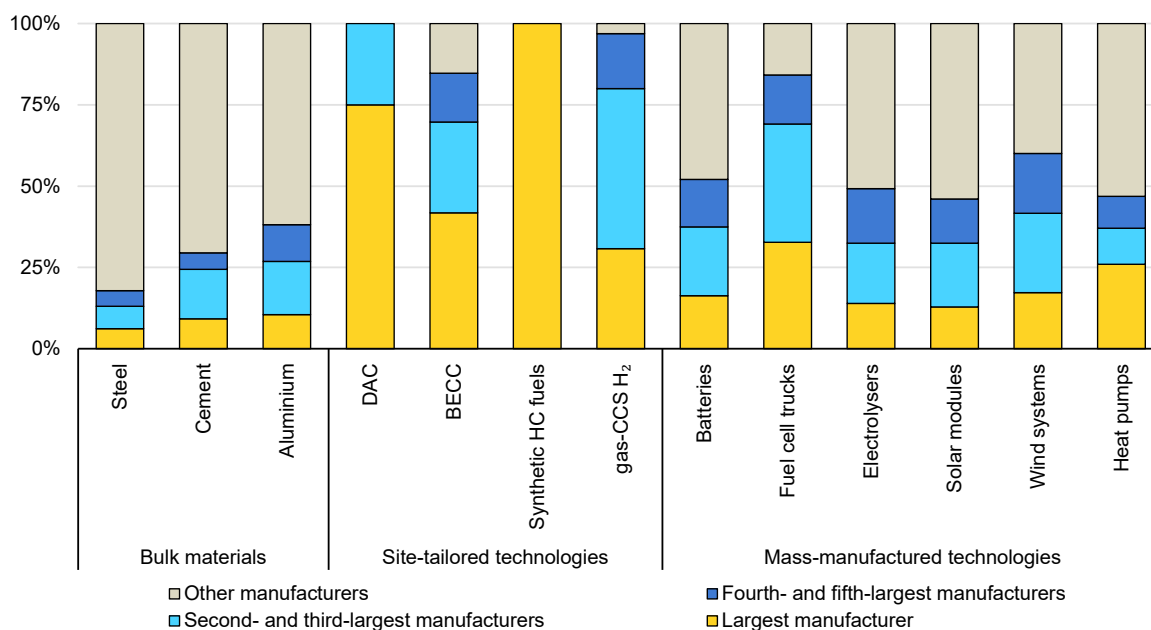
Figure 6.9 Concentrations of the largest enterprises in global manufacturing capacity and material production, 2021

IEA. CC BY 4.0.

Notes: DAC = direct air capture; BECC = bioenergy with carbon capture; gas-CCS H₂ = natural gas-based hydrogen with carbon capture and storage. Synthetic HC fuels refers to low-emission synthetic hydrocarbon fuel production. "Electrolysers" includes proton exchange membrane, alkaline, and solid oxide electrolysers. Manufacturing capacity for electrolysers includes capacity for chlor-alkali electrolysers. Manufacturing capacity refers to maximum manufacturing capacity in the case of bulk materials (i.e. steel, cement, aluminium) and mass-manufactured technologies (i.e. EV batteries, fuel cell trucks, hydrogen electrolysers, solar PV equipment, wind systems and heat pumps) and installed production capacity in the case of customised technologies (i.e. DAC, BECC, synthesis and natural gas-CCS H₂).

For several clean energy technologies, the top three manufacturers together account for more than half of global manufacturing capacity.

For mass-manufactured technologies, the picture is more mixed. A small number of companies dominate the global market, with the top three manufacturers together accounting for at least around one-third of global manufacturing capacity in each case. For electrolysers, solar PV equipment and heat pumps, concentration is somewhat lower, with the top five manufacturers accounting for less than half of production.

The clean energy transition is already having a major impact on the energy sector's corporate landscape. Many new companies are emerging to meet growth in demand for finished products and materials needed for their supply chains, notably in EV, heat pump, fuel cell truck and DAC manufacturing, while several well-established manufacturers and energy companies are diversifying into clean energy technologies, leveraging their know-how and expertise in related fields. As global manufacturing capacity increases to meet growing demand for clean technologies as the clean energy transition progresses, the diversity of corporate players is likely to continue growing as opportunities for new entrants expand, provided markets remain open and competitive.

Some new participants may enter the market horizontally, by gradually shifting production from their current core clean energy business to other technologies or components, such as solar PV manufacturers transitioning to batteries and EV manufacturers to stationary batteries. Other enterprises may integrate vertically, by beginning to manufacture key components or materials not readily available on the market, or by reinforcing their supply chain, such as car manufacturers that move into battery manufacturing. For the most innovative and least deployed applications, new market players may emerge from research centres and academia to exploit promising ideas and validate them by developing prototypes and advancing to pre-commercial demonstration, with the eventual aim of large-scale commercialisation.

Horizontal expansion can help increase the diversification of certain markets by adding more companies, thereby reducing the risk of monopoly/oligopoly and market instability. Horizontal expansion can allow companies to build on their existing capacity to expand their business. It can optimise production processes and logistics to reduce the overall cost of some of the shared components and goods. Horizontal expansions have already occurred in several companies looking to shift their core markets to emerging clean energy technologies, as well as in companies seeking to diversify their portfolios away from the manufacturing of traditional energy technologies. An example of the former strategy is Ørsted, formerly known as Danish Oil and Natural Gas, which has transformed itself into an electricity company focused mostly on renewables.

Horizontal expansions often exploit similarities across assembly lines and components, leveraging expertise that can be used to make different technologies. Examples include air conditioners, commercial refrigeration units and heat pumps. For instance, around 75% of total heat pump production is from manufacturers already producing air conditioners. Some commercial refrigeration manufacturers have also started to produce large heat pumps (Star Refrigeration, n.d.). Synergies also exist within the EV automotive sector (Hyundai, 2020), where heat pumps provide air conditioning and where similar skills for aluminium casting are required both for manufacturing of automotive parts and heat pumps.

When opportunities to exploit such synergies do not exist, particularly for large projects involving multiple competences, partnerships can support horizontal expansion. For instance, a utility and a green steel company signed a EUR 2.3-billion green hydrogen deal in 2021 (Iberdrola, 2021). Such expansions might also allow companies to enter clean energy technology markets more quickly than if they invest individually.

In most cases, vertical expansions, which involve a company moving into supply chain activities upstream or downstream of its existing business, are aimed at reinforcing the company's position in its existing business by securing key components and materials for future expansion. For example, in 2022 an alkaline

electrolysis manufacturer acquired an electroplating company to bring in-house one of the core production processes for electrolysers (Sunfire, 2022). EV battery and electric car manufacturers are also expanding into the lithium mining and refining business to increase the resilience of their supply chains.

Vertical expansions can allow companies to exert more control over their supply chains, reducing the risk of disruptions. However, they can lead to more concentrated markets, which tend to be more vulnerable. Vertical expansions are obviously most attractive for companies facing acute uncertainties about their component and material supplies. But, as with horizontal expansions, they can also help optimise production processes, product quality controls and standards compliance. On the other hand, vertical expansion might limit operational flexibility and lock manufacturers into single, specific technology solutions, eliminating the possibility of switching supplier as market conditions change and technologies evolve.

Policy recommendations

Diversifying supply chains by reducing reliance on individual countries, firms or technologies can reduce risks to supply chain security. Given the scale of clean energy technology deployment required to achieve net zero emissions, new opportunities are likely to emerge for firms and countries with access to resources, skills and capital to enter the market, potentially leading to greater diversity. Significant opportunities exist to diversify most mineral supplies by developing new reserves, but this could come at a cost, as incumbent producers have an inherent cost advantage. As a result, governments need to step in to encourage investment in new facilities. There are a number of ways in which they can do so, including developing geological surveys for mineral resources, building stockpiles of these minerals, incentivising investment in new mines and facilities across regions, and coordinating supply chain assessments and experience-sharing.

Develop geological surveys for critical mineral resources

Governments have the primary responsibility for mapping critical mineral resources. National geological surveys provide scientific information about a country's natural resources and essential data and analysis on a variety of commodities and minerals, including the technical and economic potential for developing new sources of supply. To promote critical mineral supply diversification, governments need to devote adequate funding to geological surveys. They should also support critical mineral mapping efforts in other countries that do not have the resources or capacity to do so. This can include direct funding, sponsoring mapping initiatives and providing technical assistance. Enhanced co-operation and knowledge-sharing among geological surveys can contribute to a better understanding of resource endowment and, in the long term, enhance prospects for major new sources of supply. Collaboration and data-

sharing efforts can also enable better mapping and tracking of critical mineral stocks, which can improve understanding of supply disruption vulnerability and which resources might become available through recycling.

Consider critical mineral stockpiles

It is important that governments evaluate the need to introduce or bolster stockpiles of critical minerals as a means of weathering short-term supply disruptions. Some countries have been operating mineral stockpiling schemes for many years. The United States operates a stockpile primarily for national security reasons and more recently to support the clean energy transition. Critical mineral stockpiles are usually funded through a public procurement process. Such stockpiling schemes need to be carefully designed, based on a periodic review of potential vulnerabilities, and ensure that they do not exacerbate shortages and drive prices up in the short term. In general, such schemes can be more effective for minerals with smaller markets, opaque pricing and a concentrated supply structure than for those with well-developed markets and ample liquidity.

At the IEA Ministerial in 2022, member countries recognised the growing importance of critical minerals and materials for clean energy transitions and undertook to investigate the option of stockpiling alongside other potential mechanisms such as public procurement via offtake agreements, regular stress-testing, joint recycling targets and measures to reward good ESG performance. Several countries interested in closer co-operation launched a voluntary IEA Critical Minerals Security Programme, which will include stockpiling and, potentially, other elements such as recycling and resilient and transparent supply chain mechanisms. Participating countries have agreed to work together and share experience and data from their national programmes. The programme aims to strengthen IEA activities on market monitoring, technology innovation, supply chain resilience, recycling, environmental and social standards and international collaboration (IEA, 2022g). Planned near-term activities include:

- Systematic market monitoring to identify potential areas of stress in mineral supply based on the latest policy, technology and investment trends.
- Creating a platform for policy and technology dialogue on critical minerals to facilitate knowledge exchange and experience-sharing. The platform will also discuss various measures IEA member countries can undertake together to ensure secure and transparent mineral supply chains.
- Establishing a comprehensive, freely accessible database of policy measures taken or planned by governments around the world to ensure reliable supplies of critical minerals.
- Strengthening efforts to collect data systematically in areas for which reliable public data are scarce, such as recycling, environmental and social performance, and RD&D.

Design industrial strategies to incentivise investment

Governments have a number of options at their disposal to design their industrial strategies. Every country has a different starting point and different goals, so no single one-size-fits-all strategy exists. The initial step is to define what the strategy aims to achieve, especially if those aims extend beyond interventions to structurally improve industrial performance. Sustainability, resilience and strategic independence are all widely accepted goals to include within a broader definition of “performance”, but interventions to incentivise investment must be designed in accordance with international trade regulations, such as those of the World Trade Organization.

Stimulating domestic manufacturing is often the first consideration of countries seeking to alleviate geographic concentration. Here in particular, realistic goals must be clearly stated at the outset. Total self-sufficiency is not realistic when it comes to clean energy technology supply chains. Even for large, diversified economies, failing to prioritise the areas that would be of greatest benefit to incentivise, or to carefully consider strategic and competitive opportunities when mandating domestic capacity (or re-shoring capacity that has been relocated), could lead to inefficient resource allocation.

Once priorities are established, a combination of “push” policies targeting the supply of a given mineral, material or manufacturing plant and “pull” policies, designed to boost demand for outputs from the manufacturing sector, can be introduced. These industrial strategies should be designed in co-ordination with broader horizontal measures in the energy and climate policy domains, such as carbon pricing, energy efficiency incentives and material efficiency strategies.

When stimulating domestic supply is not a viable or efficient option, countries may benefit from considering strategic partnerships. Diverse partnerships with multiple partners are preferable to overreliance on a single bilateral arrangement. Such strategies can be used to bridge gaps in the supply of a mineral, material or technology that is critical to the functioning of a domestic industry. Securing supplies of critical minerals and bulk materials produced with substantially lower emissions are key areas where this strategy may produce a more efficient solution, albeit with reduced strategic autonomy relative to domestic production. For energy-intensive commodities, consideration should be given as to which specific steps in the supply chain offer the greatest benefits when situated domestically (e.g. taking account of employment and value-added advantages, existing R&D competences, and the availability of low-cost, low-carbon energy resources), and which might be more competitively hosted by a suitable strategic partner.

Governments have several tools at their disposal (see Box 6.9) that can be deployed both domestically and internationally to reduce the risk of capital-intensive projects and incentivise private investment:

- Tax incentives, such as investment tax credits, can specifically target mines, plants and factories, and associated equipment.
- Grants for building early-mover facilities that support clean technology supply chains can reduce project risk and lead to learning and cost savings for the next facilities.
- Low-cost loans, insurance and loan guarantees can be effective instruments for projects that cannot attract adequate financing from commercial banks, which is often the case for clean energy technologies and their supply chains.
- Lower royalties for strategic mining projects that support clean energy transitions, while still maintaining support for local communities, can make such investment more attractive to private investors.
- Differentiated markets can be established and regulated for products produced with substantially lower emissions.

National development banks (NDBs) can be important in catalysing investments in key parts of supply chains. They can combine different sets of financial instruments to meet the needs of a specific project, from pre-investment support such as grants and technical assistance, to investment support such as credit enhancements, funding subsidies, loans and guarantees (IDB, 2013). The governments of many emerging economies where large chunks of the energy sector are publicly owned are facing severe difficulties in obtaining financing for energy projects. International concessional financing, through bilateral agreements or administered through multilateral development banks, can play a critical role in filling financing gaps in these countries by funding capacity-building or providing debt and equity financing to clean technology supply chain projects (IEA, 2022c).

In addition to specific financial instruments, governments should prioritise efforts to stimulate private investment in clean energy technologies within the framework of domestic industrial policies by signalling activities, areas or regions of interest for technology supply chains. For example, the development of strategic roadmaps for a given region or technology can incentivise investments in new mines, processing facilities and factories.

Box 6.9 Case studies: Support for new mines and manufacturing plants

In 2021, the Australian government established the Critical Minerals Facility, with a budget of AUD 2 billion, to support critical mineral projects under its Critical Minerals Strategy. Managed by the Australian export credit agency Export Finance Australia, the facility provides loans, loan guarantees, working capital support and bonds to mining and processing facilities. As of April 2022, three projects had received loans:

- EcoGraf Limited received an AUD 40-million loan to develop the Australian Battery Anode Facility in Western Australia.
- Renascor Resources received an AUD 185-million loan to develop an integrated graphite mine and processing facility in South Australia.
- Iluka Resources received an AUD 1.25-billion loan to develop Australia's first integrated rare-earth element (REE) refinery in Western Australia. The refinery will produce REE oxide products (praseodymium, dysprosium, neodymium and terbium), which are used in permanent magnets in EVs, power generation and defence.

Tax and royalty incentives for critical mineral mining projects are also available in some jurisdictions. For example, the Northern Territory government allows royalty payments from mineral extraction projects to be deducted from income tax payments. In Western Australia, where lithium mining is prevalent, royalties are capped at 5% of the value of the lithium concentrate produced.

In the United States, the DOE's Loan Programs Office (LPO) provides loans and loan guarantees to qualifying clean energy projects to address shortfalls in financing from the commercial debt market. The LPO has identified critical minerals for use in EV batteries and charging infrastructure as a key area of interest, enabling projects to access debt capital at US Treasury rates. Approximately USD 20 billion in loans and guarantees is available for projects along the battery supply chain, including in mining, extraction, processing, manufacturing, assembly, recovery and recycling. In addition to low-cost financing, the US established a new advanced manufacturing production credit under the Inflation Reduction Act to incentivise the domestic production of various components, including applicable critical minerals used in renewable energy generation, storage and related manufacturing. Under the regulation, a tax credit equal to 10% of the cost of production is awarded to producers of applicable critical minerals produced in the United States.

India has introduced incentives for manufacturing EVs and their components, including advanced-chemistry EV batteries, in response to the supply uncertainties caused by the Covid-19 pandemic. Two schemes under a national production-linked incentive programme jointly provided incentives worth INR 440 billion (USD 5.3 billion) in 2021. The schemes aim to secure critical supply chains as well

as promote domestic manufacturing and value-added production in the economy. The National Programme on Advanced Chemistry Cell Battery Storage aims to achieve manufacturing capacity of 50 GWh. In July 2022, the government selected three companies under this programme, with production expected to begin in 2024. The scheme was oversubscribed, with qualified bids totalling 128 GWh.

Sources: India, Ministry of Heavy Industries (2021); India, Ministry of Heavy Industries (2022); Export Finance Australia (2021); Export Finance Australia (2022); S&P Global (2022b); Western Australia, Department of Mines, Industry Regulation and Safety (2019); United States, DOE (2022f); Invest India (n.d.).

Co-ordinate supply chain assessments

International organisations and forums are natural avenues for countries to discuss supply chain questions, share best practices and experiences, and co-ordinate assessments. Governments have already started to convene meetings to discuss ways to build supply chain resilience. For example, the United States hosted a supply chain summit with 14 countries and the European Union in October 2021, as well as a Supply Chain Ministerial Forum in July 2022 to seek consensus on how to reinforce supply chain resilience. Yet there is no dedicated channel for continued dialogue focused on supply chain issues for clean energy technologies. Networks of existing international forums should be leveraged to establish such a platform.

One option is to create a new workstream focused on clean energy supply chains under the Clean Energy Ministerial (CEM). The CEM is a high-level global forum to promote policies and programmes that advance clean energy technologies and to share lessons learned and best practices. Nearly 30 countries participate in the CEM across 20 different workstreams focused on various clean energy technologies and solutions. A new cross-cutting workstream on clean energy supply chains could leverage the efforts and knowledge base of existing workstreams. The CEM Transforming Solar Supply Chains initiative could serve as a potential model for a broader cross-cutting workstream on clean technology supply chains. Launched at the Global Clean Energy Action Forum in September 2022, this initiative focuses specifically on the solar PV manufacturing value chain, including raw materials, polysilicon, ingots, wafers, cells and modules, and associated equipment. The initiative will aim to boost overall supply chain capacity and resilience by supporting large-scale manufacturing in different regions around the world.

Government co-operation with the private sector is also needed to ensure secure clean technology supply chains. Often, companies are not fully aware of their supply chain vulnerabilities and threats to them, nor have they developed mitigation and emergency response measures (EC, 2021c). To this end, governments can provide guidance to companies to assess and manage supply

chain-related risks (e.g. detailed methodologies, common definitions, vulnerability and impact indicators, and recommended mitigation measures). Governments can also act as a centralised resource to help improve integrated monitoring and reporting of vulnerabilities for clean technology supply chains. Learning from existing initiatives – such as the COMET Framework, which creates a robust carbon accounting system for emissions-reporting across supply chains, or Trase, which maps the international trade and financing of commodities – governments can provide common monitoring and reporting frameworks to better assess supply chain risks.

Boosting supply chain resilience

Reducing and diversifying critical inputs to clean technology supply chains are the primary ways to make clean energy and technology supply chains more resilient, i.e. better able to cope with and limit the impact of market shocks such as price instability. The resilience of a supply chain can be measured by the time required to scale up production of a supply chain element in the event of a rapid increase in demand or a price shock, and by whether market-ready alternatives, or spare capacity, exist for this particular element. For example, long lead times mean risks to resilience are more acute at the mining stage for mass-manufactured systems, owing to reliance on certain minerals, while low resilience for large-scale, site-tailored systems is driven by reliance on CO₂ and hydrogen infrastructure, which also feature long development lead times. Our assessment of threats to the resilience of clean energy and technology supply chains demonstrates that infrastructure for transporting and storing CO₂ and hydrogen present the most acute risk. Mining of critical minerals is also a vulnerable step, particularly for mass-manufactured systems for which alternative technologies are not yet available, but constitutes a relatively lower risk to resilient supply chains (Figure 6.10).

Figure 6.10 Risk to resilience of global selected clean energy and technology supply chains

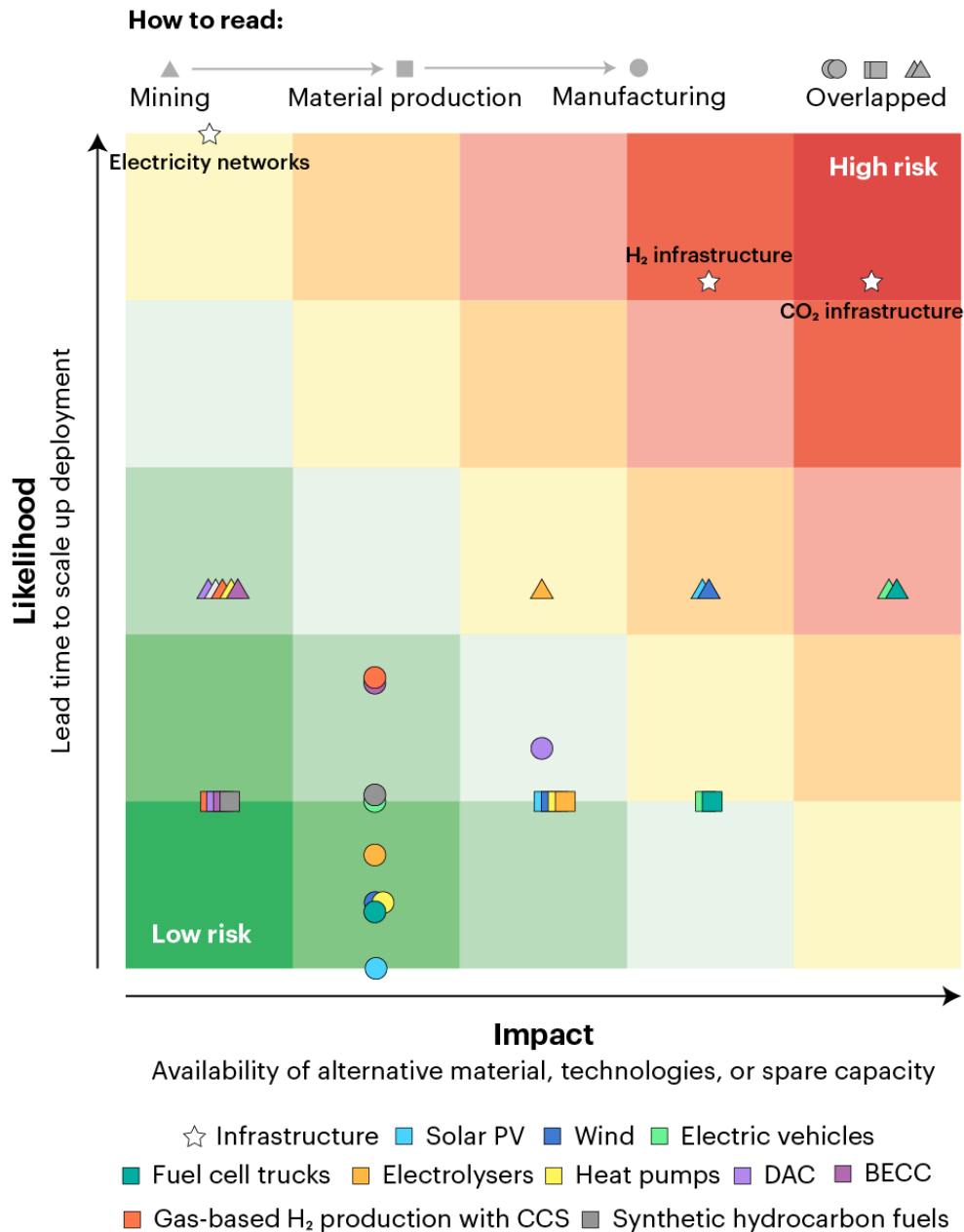

IEA. CC BY 4.0.

Notes: BECC = bioenergy with carbon capture; DAC = direct air capture. The likelihood of a threat to resilience is based on lead times to deploy a new facility on a scale of 0 (shortest lead time: around 1 year) to 10 (longest lead time: around 10 years). When multiple facilities (e.g. for mineral refining and bulk material production) are involved at a given step of the value chain, the lead time corresponds to the maximum value. Impact is measured by the availability of alternative materials, processing/manufacturing technologies, or spare capacity (using the average utilisation rate of existing capacity), evaluated on a scale of 1 to 5, with 1 corresponding to readily available and 5 to unavailable. Arrows indicate how individual points are connected within a supply chain (here with the example of solar PV).

Sources: IEA analysis. For data sources and further background on the lead time analysis see Figures 1.15 (mining) and 1.16 (material production manufacturing, installation and infrastructure).

The least resilient steps are mining for mass-manufactured systems with low availability of alternative technologies or chemistries, and infrastructure development for systems that involve CO₂ or H₂ management.

Strategic considerations

Short-term disruptions in clean technology supply chains can have profound cost implications and undermine the world's chances of reaching net zero emissions by mid-century. Boosting supply chain resilience can enable quicker responses to these disruptions. Earlier in this chapter we covered some ways to improve supply chain resilience (such as shortening lead times) to accelerate the clean energy transition. Other key approaches to enhance the resilience of these chains are to ensure stable and affordable pricing through continued access to low-cost renewables as a way to hedge against energy and commodity price swings, especially as energy transitions require greater reliance on electricity, and to promote material substitution and design diversification to reduce demand for individual critical minerals and increase resilience to supply constraints.

Energy prices and competitiveness

Maintaining stable and affordable prices for energy and commodities – particularly those that are traded in competitive international markets – is critical to ensure the resilience of clean energy technology supply chains. International markets with many suppliers generally lead to more stable and affordable prices, but countries also must also capitalise on their strengths when shaping their role in the new global energy economy. Most countries will need to choose which supply chains and steps to specialise in, due to their resource limitations and other constraints. Maintaining an economically sustainable position in these markets will help lower the frequency and severity of price shocks – and reduce exposure to them when they do occur. Competitiveness is therefore a key consideration when governments are designing their industrial strategies and assessing those of their key suppliers.

Energy is a key component of overall production costs, especially in heavy industries such as steel, chemicals and cement. Natural gas and electricity are the two main energy inputs for material and technology manufacturers today, the prices of which, including taxes and excises for industrial users, vary significantly between countries (Figure 6.11). This gives producers in regions with relatively low energy costs a competitive advantage. For example, prices for industrial users of natural gas and electricity remain far lower in the United States than in Europe, creating an incentive for some manufacturers to shift production. The prices of coal and oil products, which are more easily traded internationally (as transport costs represent a smaller share of the price), vary much less among regions, excluding the impact of taxes (e.g. from emissions trading schemes).

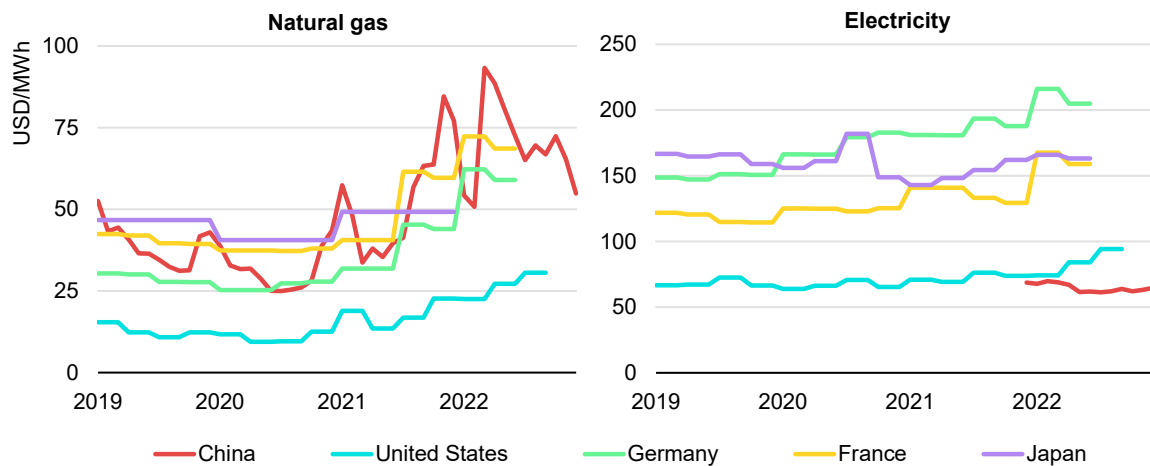
Figure 6.11 Industry end-user prices for natural gas and electricity in selected countries

IEA. CC BY 4.0.

Notes: Data for gas are from the China LNG Factory Price National Index. Electricity data are calculated from the “grid proxy electricity tariff for 30 provinces and cities in China”. Electricity data for China not available prior to reforms to liberalise markets at the province level in October 2021. Prices include taxes and are shown in 2021 US dollars using market exchange rates.

Sources: IEA (2022h); Shanghai Petroleum and Gas Exchange (2022); State Grid Corporation of China (2022); China Southern Power Grid (2022).

Energy prices for industrial users vary considerably between regions, creating a structural advantage for producers of energy-intensive products in regions with low energy costs.

The clean energy transition will entail greater reliance on electricity, so if regional differences in electricity prices persist, the result will be considerable cross-region variations in the production costs of a wide range of energy products and bulk materials. Based on recent grid electricity prices, producing low-emission hydrogen using grid-connected electrolyzers would cost 120% more in Western Europe and Japan than in China, and 80% more than in the United States (Figure 6.12). Western Europe becomes much more competitive when considering the production costs that could be achieved using low-cost variable renewable energy (VRE) provided by solar PV and wind installations. Hydrogen production costs of around USD 6/kg in Western Europe, USD 9/kg in Japan, USD 5/kg in the United States and USD 4/kg in China could be achieved using the better renewable resources in these countries today.

Substantially lower costs – with less variation between regions – can be envisaged if countries are successful in implementing their announced pledges. As electrolyser costs decline rapidly in the APS, together with continuing declines in the cost of solar PV and wind, hydrogen production costs using electrolysis and low-cost VRE could drop to USD 1.3/kg by 2030. This would make low-emission hydrogen via electrolysis competitive with the reference production cost of USD 1.4-4.4/kg, using today’s main incumbent pathway (steam methane reforming using natural gas). These production costs exclude the impact of any

direct subsidies, such as those offered in the US Inflation Reduction Act. The Inflation Reduction Act makes available effective subsidies of up to USD 3/kg for hydrogen produced with renewable electricity, relative to domestic production costs in the APS in 2030 of USD 1.7-3.0/kg.

Virtually all hydrogen is consumed where it is produced today because transporting and storing it is expensive. Therefore, countries' domestic hydrogen producers are not in direct competition with one another. This is not the case for chemicals and materials such as ammonia and crude steel, which are traded in competitive international markets and have the potential to be produced in large volumes using low-emission hydrogen in the future (the technologies for doing so are still in the demonstration phase today).

If ammonia and steel were manufactured using low-emission electrolytic hydrogen produced from grid electricity, the wide variation in production costs between regions would lead to significant competitiveness gaps. As for low-emission hydrogen, these differences persist – although narrow markedly – in the APS when VRE is used, with production costs in the range of USD 480-1 500/t for ammonia and USD 520-980/t for crude steel in 2030. The key to making such process arrangements viable is flexibility, by adapting the process technology to accommodate some degree of variation in its load/capacity factor, or by storing surplus hydrogen or electricity when renewables output is at its highest.

Figure 6.12 Indicative production costs for hydrogen and hydrogen-based commodities produced via electrolysis

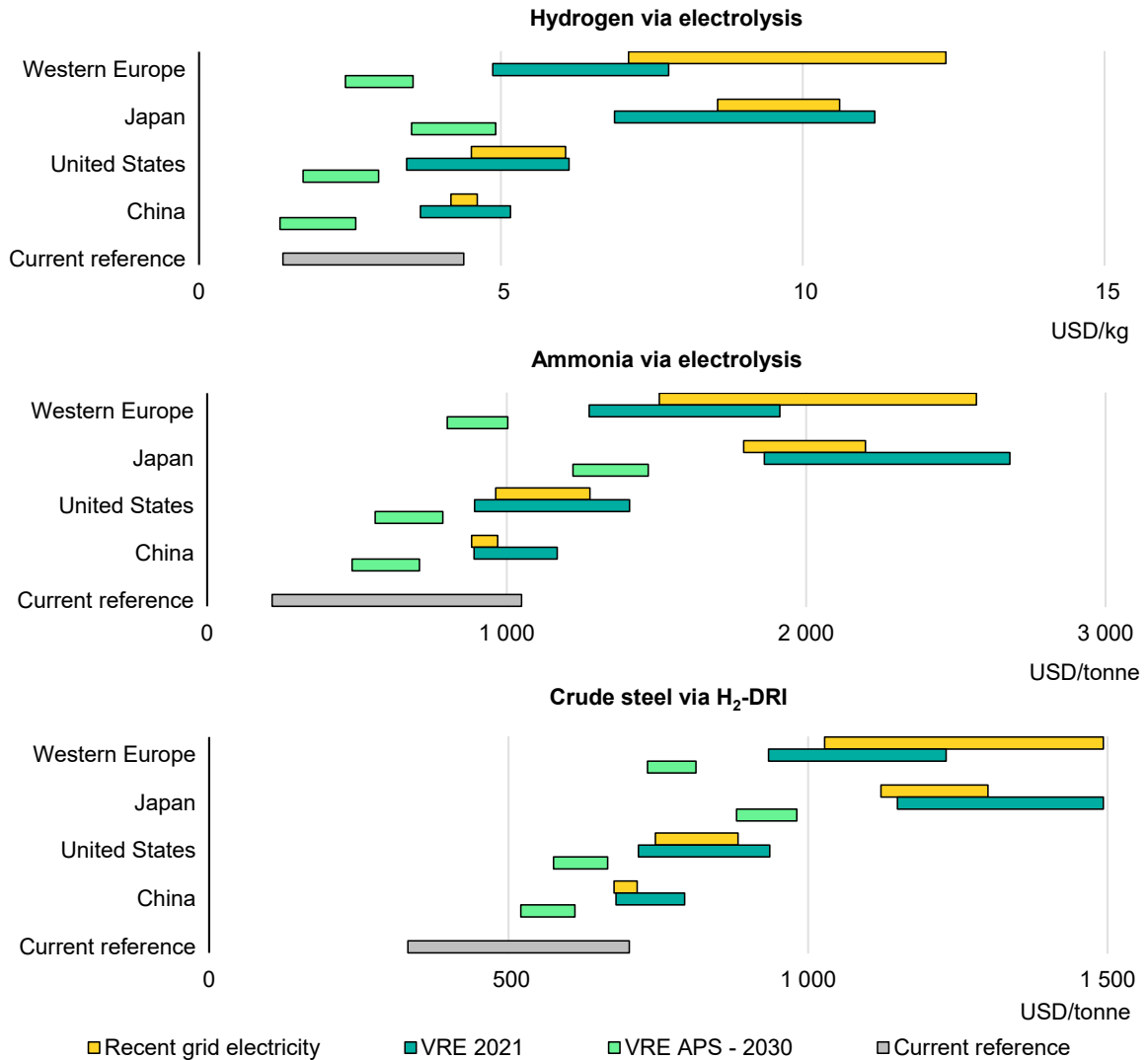

IEA. CC BY 4.0.

Notes: VRE = variable renewable energy ; APS = Announced Pledges Scenario; H₂-DRI = hydrogen-based direct reduced iron. The VRE cost range represents electrolysis powered by solar PV, offshore wind or onshore wind. For ammonia and crude steel production, an additional hydrogen storage cost to guarantee a minimum load of 80% is considered. 'Current reference' values show production costs using the dominant incumbent means of production today with unabated fossil fuels. Recent prices for natural gas and grid electricity (as per Figure 6.11) are used to compute the cost ranges in each region where relevant. The cost of capital is assumed at 5%, while the other techno-economic assumptions are sourced from the references below.

Sources: IEA (2022h); IEA (2022i); IEA (2020b); IEA (2021b); S&P Global (2022c); Bloomberg (2022).

Considerable variations in electricity costs for industrial users between countries have implications for the competitiveness of industries exposed to international trade.

Substituting alternative materials and designs

Material substitution and design diversification are important to reduce demand for individual critical minerals and increase resilience to supply constraints. This can include pursuing alternative designs that are overall less reliant on materials with potential for supply bottlenecks or constraints. It may also include pursuing a

portfolio of designs in parallel, such that if supply constraints arise for one particular critical material, it could be possible to pivot to increase manufacturing of an alternative design that is dependent on different materials.

Alternative chemistries for making EV batteries are one example of such material substitution. The cathodes of EV batteries historically tended to be made with significant amounts of cobalt, but they have recently been substituted by variants that have higher nickel content and less cobalt. This trend is the result of a search for better performance, as well as industry attempts to reduce reliance on cobalt – a costly metal supplied as an ore mainly from the Democratic Republic of Congo. Manufacturers are now also turning to less nickel-intensive cathode variants with similar efficiencies and energy densities, such as lithium iron phosphate (LFP). These are gaining a major foothold and their share of total battery production increases rapidly, to around 30% by 2030 in the NZE Scenario (Figure 6.13).

LFP chemistries are less reliant on constrained materials, cheaper and more durable, though their energy density is less than that of nickel-based ones (100-160 watt-hours [Wh]/kilogramme [kg] compared with 160-250 Wh/kg). As such, they are best suited to stationary energy storage applications, but can be an attractive option for certain EV types due to their cost advantage. In addition, efforts are being made to make cathodes with more manganese to reduce the cobalt and nickel content, lowering costs and reducing the risk of disruptions to nickel supply.

Compared to the status quo, this substitution and diversification makes EV supply chains more resilient to shocks in certain battery metal prices. However, there is a trade-off: this potential to switch materials could threaten the economic viability of potential future resource extraction projects, potentially slowing the pace of required investment. If critical mineral prices remain higher for longer, automakers would likely respond strongly to this market signal by shifting more quickly to LFP cathode chemistries (as represented in the Figure 6.13 “constrained” case).

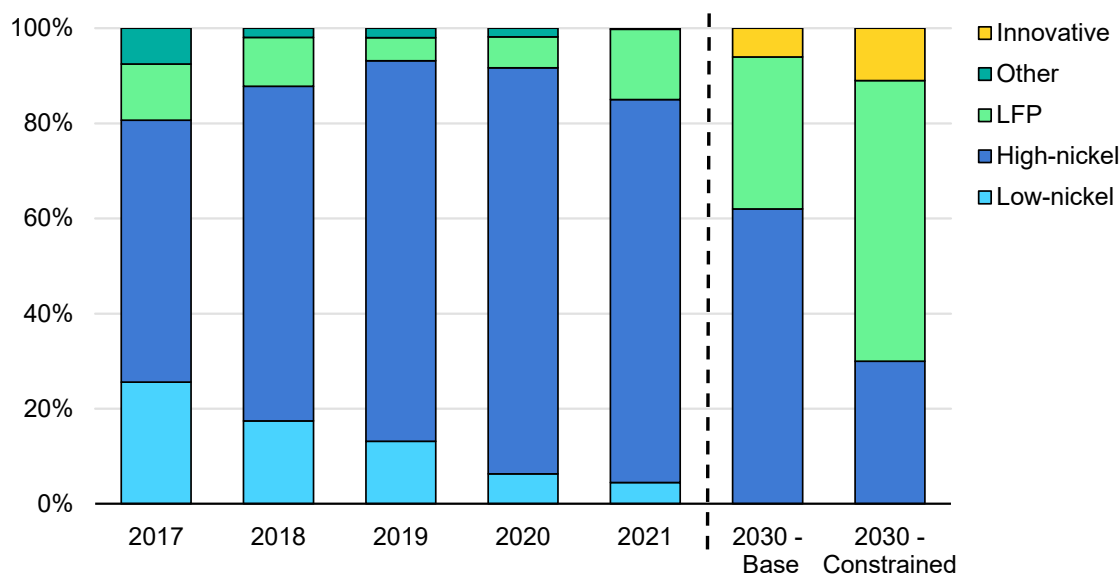
Figure 6.13 Global cathode production for passenger light-duty BEVs by chemistry in the NZE Scenario

IEA. CC BY 4.0.

Notes: NZE = Net Zero Emissions by 2050 Scenario; BEV = battery electric vehicle; LFP = lithium iron phosphate. “Low-nickel” includes: NMC333. “High-nickel” includes: NMC532, NMC622, NMC721, NMC811, NCA and NMCA (NMC = lithium nickel manganese cobalt oxide; NCA = lithium nickel cobalt aluminium oxide). The cathode sales shares are based on production capacity.

Source: IEA analysis based on IEA (2022d); EV Volumes (2022).

Switching away from high-nickel chemistries to LFP batteries could reduce the need for nickel extraction and processing.

An important goal of battery innovation efforts is to diversify designs to reduce reliance on lithium, the critical mineral that is least substitutable with current technologies and the one facing the largest potential shortfall in supply in upcoming years based on planned projects (see Chapter 3). Sodium-ion batteries are a promising alternative, but they are approximately ten years away from widespread commercialisation. Machine learning can be used to help accelerate the development of novel battery materials to improve battery density and reduce reliance on key battery metals such as lithium, nickel and cobalt (NREL, 2021).

Electrolysers are another key technology for which pursuing a mix of different designs could help reduce reliance on specific critical mineral inputs. Alkaline electrolysers require a significant amount of nickel, which is also needed to make EV batteries and therefore increases pressure on global nickel production. Polymer electrolyte membrane (PEM) electrolysers use iridium, which currently has limited applications and for which it is difficult to ramp up global production, as it is produced as a by-product of platinum group metal and nickel mining (Kiemel et al., 2021). Future nickel and iridium demand could be moderated through further innovation. Additionally, developing different technologies means that if an unforeseen supply shock drives up the price of one mineral, electrolysers using another mineral could emerge as an economically viable alternative.

Innovation will be critical in this regard. Electrolyser manufacturers are already trying to reduce precious metal loadings using improved manufacturing techniques such as novel catalyst formulations and coating techniques (EC, 2022b; Heraeus, 2022; H2U Technologies, 2022). Bringing to market and scaling up other designs such as solid oxide electrolyser cells and anion exchange membrane electrolysers can also help lower critical mineral needs and enhance the flexibility of electrolyser supply chains. In addition, highly innovative electrolyser designs that are approaching commercialisation are also adopting strategies to minimise material needs. Hysata's design uses a capillary system that results in a step-change in efficiency compared with conventional designs (95% compared with around 75%), which leads to lower material needs per unit of hydrogen output and a simplified balance of plant (the supporting components and auxiliary systems of the plant) (Hysata, 2022). Clean Power Hydrogen (CPH2) has a membrane-free electrolyser technology that avoids the use of platinum-group metals and reduces the risk of stack failure, which can increase the operative life of the system (CPH2, 2022).

Policy recommendations

Improving resilience can be achieved with increased material efficiency through more recyclability, repairability and reuse to reduce primary material needs. A number of policy options are available to governments to encourage these practices, including standardisation of rules affecting repairs, incentives to support material efficiency, mandates and other measures to improve recyclability and recycling rates, and various measures to promote the repurposing of existing infrastructure, such as oil and gas pipelines, to handle CO₂ and hydrogen.

Review design and manufacturing regulations

Reducing the amount of bulk or critical materials that go into a product in the first place can have an important impact on overall material demand. Design regulations can help encourage reductions in material use. For example, moving from prescriptive to performance-based design standards can facilitate the efficient use of materials while also promoting the adoption of near zero emission materials. An example here are building codes that focus on strength requirements, rather than requiring that a certain amount of cement or steel be used. Lifecycle or embodied carbon regulations can also help promote design efficiency. An example is France's RE2020 regulation, which caps buildings' embodied carbon emissions. Green labelling and certification related to embodied emissions, as well as factoring embodied emissions into public procurement decisions, can also help create demand for material efficient designs.

R&D support is crucial, particularly with regard to critical materials. Governments should support the development of designs and technologies that use reduced amounts of scarce materials, and should co-ordinate or mandate the incorporation of material-efficient design training into the curriculum of engineers and architects.

Promote repairability and longer lifetimes

Using products and technologies longer will reduce total material needs. Governments can help normalise practices to achieve this, including favouring reusable over disposal products when possible and promoting repairability, remanufacturing and second-life applications (see Box 6.10).

Policy intervention at the design stage is important. Bans on certain single-use products can spur the design of reusable products. Requirements to build repairability into design can prevent planned obsolescence. One example is requirements for component standardisation under product stewardship regulations. Incentives for modular design can also facilitate future repurposing.

Government programmes can also facilitate repairing and repurposing. They could set requirements covering both manufacturers and importers to make spare parts available, and facilitate remanufacturing and second-life applications such as the collection of end-of-life EV batteries for use in stationary applications, provided adequate safety precautions are in place. Tax incentives and disincentives could also be used, e.g. reduced property taxes on a building that has been repurposed by a new owner or taxes on building demolitions.

Box 6.10 Case study: EU right-to-repair rules

The European Union's Ecodesign Directive provides a framework for the development of detailed rules to improve the environmental performance of a wide range of energy-intensive products such as household appliances, information and communication technologies, and engineering goods, as well as products that affect energy use such as windows and insulation. To enhance the repairability of these products, the directive requires manufacturers and importers to improve the design of certain products, make essential spare parts available and allow independent repairers access to technical information to help them repair products.

As part of the EU Green Deal, the European Commission has proposed to expand the directive to cover other product groups that have a significant environmental impact, including steel. Among other areas, the proposal includes:

- Creating a set of requirements tailored to the particular characteristics of the product groups concerned.
- Expanding the coverage of the requirements to product durability, reliability, reparability and ease of maintenance, as well as energy use, resource use and minimum recycled content, and waste prevention and reduction.
- Implementing a digital product passport for the product groups covered by the proposal to help businesses and customers make informed choices through access to transparent environmental information.

- Preventing the destruction of unsold goods by requiring businesses to disclose the amounts of and reasons for product discards each year, and how they are processed. A wholesale ban on the destruction of unsold goods for certain products is also envisaged.

In April 2022, the European Parliament adopted a resolution calling for the right to repair to address the whole lifecycle of products, from product design to production, standardisation, information labelling (including reparability and expected lifespan), consumer guarantees, and public procurement. For instance, products will need to be designed so that a repairer can use common tools to replace the parts, which would prevent manufacturers from sealing their products in a way that impedes repair.

Source: National Law Review (2022).

Explore opportunities to repurpose infrastructure

When feasible, governments should consider adopting policies that encourage the repurposing of existing infrastructure, especially existing gas pipelines, which could significantly reduce the cost of establishing national and regional hydrogen transportation networks (see Chapter 5). There is also considerable potential to repurpose oil and gas pipelines to transport captured CO₂ in many parts of the world. Benefits include avoiding the need for new construction and thus material input requirements, reducing stranded assets, and reducing lead times through avoiding the need to secure new land rights and right-of-way permits.

While industry may be better placed to conduct technical reviews of existing infrastructure assets, governments can play an important role in identifying opportunities to repurpose infrastructure by commissioning repurposing studies, standardising the assessment process and offering incentives to pipeline operators to repurpose assets. Regulators can assist in the physical repurposing of infrastructure by providing clear decommissioning and permitting requirements.

When possible, governments should also encourage the reuse of retired power generation assets as the clean energy transition progresses, as well as the use of existing grid connections. For example, there may be scope to make use of the sites and associated facilities of coal-fired power plants to build new large-scale clean-energy generating plants, such as nuclear reactors or bioenergy-based combined heat and power plants (see Box 6.11). This could not only save construction costs and material needs, but also help provide employment for the local community. Policymakers can encourage this by identifying these assets and facilitating discussion among utilities, project developers and local communities to identify potential opportunities.

Government financing could also be used to promote infrastructure repurposing. For example, infrastructure banks are one medium through which governments can help mobilise private investment in infrastructure projects that might not otherwise occur. A portion of funds could be earmarked for infrastructure repurposing in support of the clean energy transition, thus encouraging the private sector to seek out relevant opportunities, including innovative repurposing projects.

Box 6.11 Case study: Repurposing fossil energy infrastructure in the United Kingdom and United States

In the **United Kingdom**, the government believes the repurposing of oil and gas infrastructure to transport hydrogen and captured CO₂ could make a major contribution to meet net zero goals. To this end, the North Sea Transition Authority (NSTA) is looking at how to maximise the repurposing of infrastructure. It has already developed a screening tool to help the operators of offshore oil and gas fields identify potential opportunities ahead of decommissioning. The tool will initially be sent to dozens of companies operating 120 fields that are nearing (or have reached) the end of their production lives. The NSTA will then review company data submissions and work with the operators to explore repurposing options and address potential barriers.

In the **United States**, the DOE released a report in September 2022 investigating the benefits and drawbacks of building nuclear reactors at coal-fired power plant sites. In addition to offering employment and local economic benefits, the study found that reusing coal infrastructure for advanced nuclear reactors could reduce construction costs by 15-35% if the coal plant's electrical equipment (e.g. transmission lines and switchyards), cooling ponds or towers, and civil infrastructure (e.g. roads and office buildings) are reused.

Sources: NSTA (2022); United States, DOE (2022g).

Design industrial strategies that leverage competitive advantages

Establishing competitive positions in international markets for clean energy technology manufacturing and material production is a central consideration when countries are designing their industrial strategies. Economically competitive production and manufacturing operations are more resilient to price and demand shocks, which in turn enables more supply resilience for customers and more resilient markets for suppliers.

A first step to establish a competitive position in a supply chain is to choose what area to specialise in. For most countries, it is not realistic (or necessary) to compete effectively across all steps of all the clean energy technology supply chains they rely on. Competitive specialisations often arise from inherent geographic advantages, such as access to low-cost renewable energy or the presence of a mineral resource, which can lead to lower production costs for

energy and material commodities. But they can also stem from other attributes, such as a large domestic market, a highly skilled workforce or synergies and spillovers from existing industries. Governments should consider the attributes that could enable competitive specialisations in their own economies, capitalising on their own strengths while also evaluating those of other countries. International organisations can be of assistance, providing comparative analysis and identification of best practices.

Over-emphasis on economic competitiveness can also hamper efforts to improve supply chain resilience. “Just-in-time” production lines and highly optimised asset utilisation are both examples of strategies to improve financial performance that – when taken too far – can come at the expense of resilience. Increased robustness, facilitated by system-level redundancy and strategic oversizing of critical nodes or elements in supply chains, including infrastructure, is increasingly important to remain competitive in volatile markets. Improving resilience through these strategies can result in increased upfront costs. But these costs can lead to considerable savings in the event of a demand shock or price spike if production and manufacturing operations are spared from disruptions and thus shielded from negative impacts on competitiveness.

Establishing sustainable supply chains

It is vital that mining, manufacturing and activities in other elements of the supply chain do not give rise to significant GHG emissions, other harmful environmental effects and/or damaging social consequences, such as human rights violations and modern slavery. CO₂ emissions from clean energy and technology supply chains currently vary markedly by step and supply chain. While the CO₂ intensity of mining of some critical minerals can be high, mining contributes little to the overall emissions stemming from clean energy technology supply chains that make use of the minerals (Figure 6.14).

In contrast, the emissions intensity of material production processes – either to supply bulk materials (for technologies such as wind turbines), critical materials (such as lithium and cobalt for EVs) or specific materials (such as sorbents for DAC or polysilicon for PV modules) – are often larger relative to that of other steps within these particular supply chains. Manufacturing processes tend to rely more on electricity and are less energy-intensive, which usually leads to lower CO₂ intensity, particularly for wind turbines, heat pumps, fuel cell trucks, and site-tailored technologies, for which manufacturing emissions are below 25% of overall supply chain emissions. For solar PV, electric vehicles and electrolyzers which involve the manufacturing of specific components such as wafers, cells, PV modules, and batteries, this share can increase to 30 to 50%.

Figure 6.14 Risk of failing to reduce CO₂ emissions in the most intensive steps of selected clean energy and technology supply chains

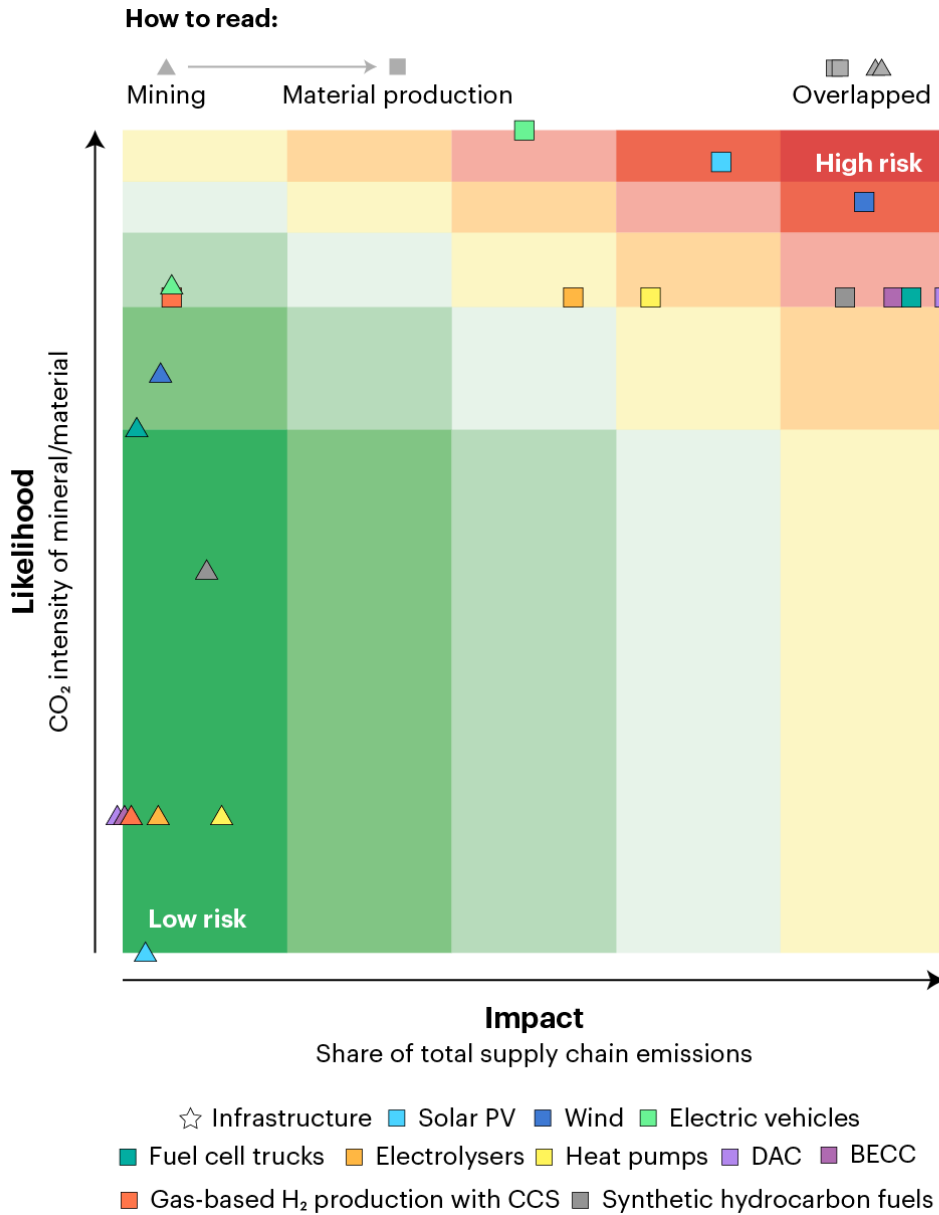

IEA. CC BY 4.0.

Notes: BECC = bioenergy with carbon capture; DAC = direct air capture. Contributions to total supply chain CO₂ emissions are calculated based on the share of each step in total supply chain CO₂ emissions. Total supply chain include direct and indirect emissions from resource extraction, material production, and manufacturing, and direct emissions from operation. Operation only represents a high share of emissions for gas-based hydrogen production with CCS, for which it is assumed that 5% of natural gas emissions are not captured. Most manufacturing process are heavily electrified and emissions are on average lower than material production, typically representing less than 25% of overall supply chain emissions for heat pumps, wind turbines, fuel cell trucks, and site-tailored systems. For solar PV, electric vehicles, and electrolysers, the share can increase to 30-50%. Likelihood is measured by the CO₂ intensity of mining and processing materials contained in the different technologies, scaled from 0 (low CO₂ intensity: around 2 kg CO₂/kg) to 10 (high CO₂ intensity: around 50 kg CO₂/kg) and represented on a logarithmic scale.

Sources: For data sources and further background on the emissions analysis see Figure 2.21. Other sources for electrolysers, gas-based H₂ production with CCS, BECC, and DAC include consultation with industries, Gerloff (2021); Cetinkaya et al. (2012); NREL (2001); Deutz and Bardow (2021); World Resource Institute (2022); Koornneef et al. (2008); Pehnt and Henkel (2009).

While the CO₂ intensity of mining of some critical minerals can be high, mining contributes little to the lifecycle emissions of the technologies that make use of the minerals.

Strategic considerations

Reducing emissions from the mining, processing, manufacturing and transport of materials and final clean energy products is essential as their deployment increases. The task of reducing supply chain emissions is made more challenging by the sheer rate of growth of supply needed to achieve net zero emissions by mid-century, as well as the prospect of a decline in the quality of critical mineral resources, which means more energy will be needed to produce each tonne of these minerals. Governments can make supply chains more sustainable by increasing the material efficiency of clean energy transitions (thereby reducing investment needs for new minerals and materials and increasing emissions savings) and by scaling-up markets for near-zero emission materials.

Boosting material efficiency for cost savings and emissions reductions

Improving material efficiency would make the task of expanding raw mineral extraction and processing less monumental. This would reduce investment needs as well as environment impacts from land-use change and habitat loss. For example, if additional material efficiency in the NZE Scenario were not forthcoming, making up the necessary production with CO₂ capture-equipped cement plants would require extra cumulative investment of about USD 225 billion (in 2021 US dollars) by 2050. Savings would be around USD 710 billion for using additional hydrogen DRI plants to make up the shortfall in steel production, with both figures excluding the significant additional savings in energy infrastructure and resource extraction investment that would also be needed.

Material efficiency gains can reduce manufacturing costs when the benefits outweigh the costs of implementing the strategy, thereby helping accelerate the uptake of clean energy technologies and lower their overall cost. For example, right-sizing EV batteries to a range that covers at least 90% of daily trips, together with policies to ensure that vehicle size and weight do not continue to increase, reduce the upfront cost of an EV by more than USD 2 500 in the NZE Scenario. Car leasing options, to enable EV buyers to lease cars with a longer range for occasional trips of more than 200 km, could be a convenient and more affordable option in such a case. Companies and countries that exploit opportunities to boost material efficiency will improve their competitive advantage, leading to greater investment, market shares and job creation.

Scaling up lead markets for near zero emission materials

As material production contributes a substantial share of supply chain emissions for clean technologies and infrastructure, using near zero emission materials will be important for supply chain decarbonisation. While costs for producing such materials are likely considerably higher than for conventional production, the impact on prices of end-use technologies is fairly small, given that materials account for a relatively small portion of final costs (see Chapter 1). Consequently,

manufacturers can pass these marginal costs on to consumers so that higher production costs do not prove a major barrier to manufacturers using lower-emission materials. Since near zero emission material production routes have not yet been commercialised, the collective purchasing power of manufacturers and consumers across multiple end-use sectors can support the scale-up of early production. Indeed, as part of their strategies to improve the sustainability of their supply chains, a growing number of companies from a range of sectors are already making commitments to procure lower-emission materials.

Recent commitments to procure near zero emission steel illustrate this. The number of companies pledging to purchase near zero emission steel is growing rapidly, with over 60 having made a commitment as of 2022, more than double the number in 2021 (Figure 6.15). This includes agreements made under industry initiatives as well as independent commitments negotiated between buyers and producers. Pledges have been made by companies in various sectors, indicating that they feel confident in passing costs through to consumers for a range of end uses.

Partly in response to these commitments, along with other public sector schemes such as the CEM's Industrial Deep Decarbonisation Initiative, a growing number of steel producers are formulating plans to produce near zero emission steel. Some companies, such as H2 Green Steel, are making these a core part of their decarbonisation strategy (see Chapter 3) (H2 Green Steel, 2022). To help accelerate the deployment of near zero emission steel production, steel buyers can send stronger demand signals regarding the size of this market by disclosing more details regarding demand commitments, including total volumes, expected emissions levels and purchase time frames.

Figure 6.15 Number of companies committed to purchasing low-emission steel by end-use sector, and global market size for selected bulk materials in the NZE Scenario

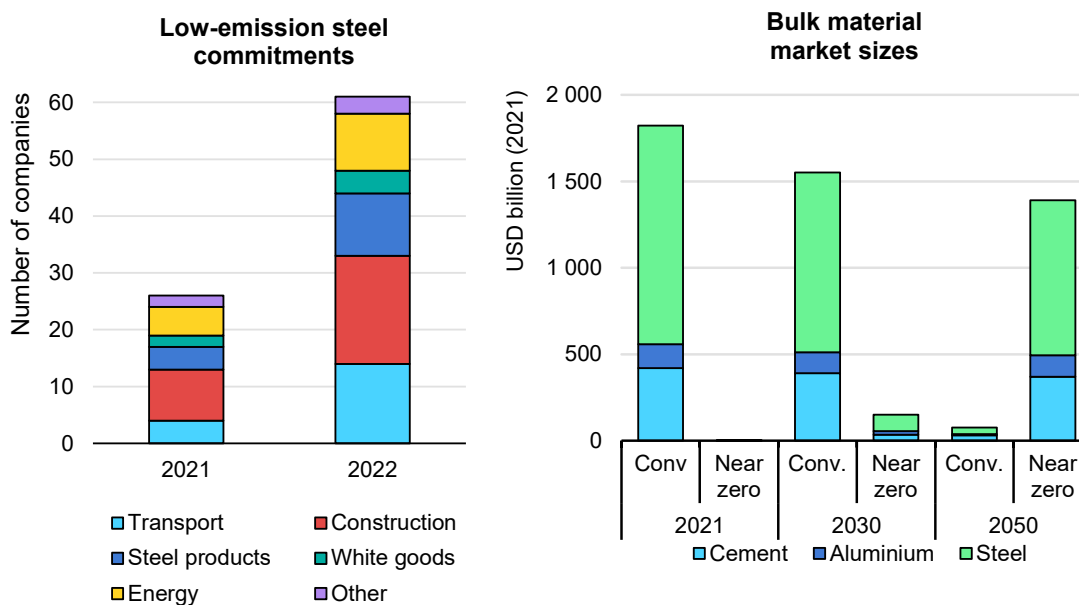

IEA. CC BY 4.0.

Notes: “Low-emission steel” is used when referring to procurement commitments, as many do not state the exact level of emissions being targeted, but rather the broader aim to purchase lower-emission steel. “Conv.” Refers to conventional production. “Near zero” indicates near zero emission production. Near zero emission steel and aluminium production is approximated on a direct-emissions basis, based on the deployment of innovative technologies in primary production only. Average market prices for 2017-2021 are used to calculate all market sizes.

Sources: IEA research based on company announcements; Bloomberg (2022); S&P Global (2022d).

The number of companies committed to purchasing low-emission steel more than doubled between 2021 and 2022, covering a diverse range of end-use sectors.

The need to decarbonise material production also generates new opportunities for investment and growth. In the NZE Scenario, the combined global markets for all crude steel, cement and aluminium shrink from approximately USD 1.8 trillion in 2021 to just under USD 1.5 trillion (in 2021 US dollars) in 2050 as demand for these materials drops. At the same time, the share of near zero emission material production jumps from almost zero in 2021 to around 95% of total production in 2050, providing opportunities for countries and companies that develop these production processes to capture new markets.

The use of novel digital tracking approaches, such as digital passports, can support efforts to scale up markets for low- and near zero emission production. SSAB’s SmartSteel 1.0 gives steel a digital identity, allowing customers to identify its material properties and download associated certificates with an app (SSAB, 2018). Digital platforms could also be used to host secondary-material markets, such as for construction materials and metals (e.g. Backacia). This is beginning to affect the wider industry, not just frontrunners, as governments look to adopt market-wide measures on traceability. For example, the European Commission’s

proposal for a Regulation on Ecodesign for Sustainable Products introduced in March 2022 requires digital passports for other clean energy technologies, including solar panels (EC, 2022c).

Box 6.12 Case study: Standards for concrete and asphalt in the United States

In March 2022, the US General Services Administration (GSA), which is responsible for centralised procurement for the federal government, issued new standards for the concrete and asphalt used in GSA construction, modernisation and paving projects. These standards establish design and performance criteria for GSA projects. To strengthen this effort, the GSA gathered feedback from manufacturers on the availability of low-carbon construction materials and products.

The new low-embodied-carbon standard for concrete requires GSA project contractors to provide environmental product declarations, when available, that summarise the primary environmental impacts of the product's extraction, transportation and manufacturing. In addition, the GSA is asking its contractors to provide concrete that meets a 20% reduction in embodied carbon compared with national GHG limits for concrete.

The new asphalt standard also requires environmental product declarations and at least two environmentally preferable techniques or practices to be used during the material's manufacture or installation. Based on industry feedback, GSA-approved techniques and practices include bio-based or alternative binders, recycled content and reduced mix temperatures.

Source: GSA (2022).

Policy recommendations

To address emissions from the mining, material production, manufacturing and transport of materials and of final clean energy products, governments can utilise a variety of policy mechanisms. For the mining and manufacturing steps, the bulk of direct emissions can be dealt with through electrification. Tax credits and rebates for highly efficient motors and industrial heat pumps can play a role, as can efficiency standards that encourage greater electrification (see Chapter 4). For bulk materials, financing measures can help promote investment in near zero emission production facilities, while emissions trading schemes can provide a broad signal for decarbonisation. Lifecycle-based regulations applied to final products and fuels could also help drive emissions reductions all the way up the supply chain, such as low-carbon fuel standards that include upstream emissions (Box 6.13).

Lifecycle approaches can help identify “hot spots” of environmental and societal concern, which can then be targeted by policymakers. A holistic view of clean technology supply chains is needed to ensure that lower overall emissions can be achieved; in this regard, it is critical that lifecycle assessments and lifecycle-based regulations incorporate end-of-life requirements. Well-conceived regulations can promote designs for component modularity, recyclability and interoperability. Finally, standardised lifecycle assessment procedures could be adopted, to reduce compliance costs and time requirements (IEA, 2019).

A range of policy options are available: minimum recycled content requirements (as described in the previous section); traceability standards; environmental, social and governance regulations; and policies to create demand for low- and near zero emission fuels and materials.

Box 6.13 Lifecycle-based low-carbon fuel standards

California introduced the world’s first low-carbon fuel standard (LCFS) in 2009. An LCFS requires regulated entities (typically fuel and energy providers to the transport sector) to gradually reduce the lifecycle GHG emissions of all the transportation fuels they sell. It sets benchmark lifecycle GHG values (typically called “carbon intensity”) for gasoline, diesel and various alternative fuels, taking into account emissions associated with all of the steps of producing, transporting and consuming the fuel. These carbon intensity values are usually revised annually, tracking reductions in GHGs emitted in producing, refining and delivering conventional transport fuels, as technologies are upgraded or replaced with more efficient ones. An LCFS allows all fuel providers the flexibility to determine which mix of fuels they supply in meeting the standards through a credit trading system.

While the LCFS mechanism itself is straightforward in principle, it can be complex to operate given the data and methodological considerations that go into lifecycle analysis to determine carbon intensity values for different fuels. It may also favour biofuels and reduce the pace of electrification if lifecycle accounting fails to effectively incorporate the effects of land-use change in producing biofuels and the true level of GHG emissions in power generation.

In light of the success of California’s LCFS, various other national and regional governments have either adopted or are considering introducing one. They have been implemented in Oregon and Washington in the United States, in Canada (known as Clean Fuel Regulations) and Brazil (Renovabio). More recently, the EU Fit for 55 programme has incorporated some aspects of an LCFS. In emerging economies such as India, where the shift to EVs is encountering technology and cost barriers, an LCFS-type mechanism may be an effective market-based approach to encourage the adoption of low-emission fuels. It may also work well in hard-to-abate transport sectors such as aviation and shipping.

Sources: Yeh et al. (2016); ICCT (2022); CARB (2022).

Increase material reuse, recyclability and recycling rates

As demand for key mineral and bulk material inputs to make clean energy technologies increases, fostering a circular approach through reuse and recycling will be increasingly important in clean technology supply chains. Governments can establish circularity roadmaps and material recovery targets to help establish the direction of progress (see Box 6.14). Policies targeting specific parts of the supply chain will also be important.

Future material reusability and recyclability should already be considered during the design and manufacturing stage. Governments can adopt product stewardship and extended producer responsibility policies to push companies that design, manufacture and sell products to incorporate end-of-life considerations into their activities. Stewardship policies make all companies involved in all stages of a product's lifecycle responsible for its end-of-life effects, while extended producer policies place responsibility on the manufacturer.

There are examples of such schemes for various products, such as extended producer responsibility requirements under the EU Waste Electrical and Electronic Equipment Directive and the Battery Directive. Such schemes could be developed or extended for key technologies within clean energy value chains. Doing so would encourage producers to develop products that can be more easily recycled and to explore options for remanufacturing, while also helping ensure sufficient investment in reuse and recycling infrastructure. Minimum recycled content requirements could also motivate manufacturers to actively participate in increased recycling. Additionally, for bulk materials, governments can obligate suppliers to buy back unused materials during construction or used materials for recycling (IEA, 2019).

Governments can also play an active role in increasing material reuse and recycling rates. Policies targeting the consumer (e.g. landfill and waste collection fees, recycling rebates and buyback programmes) can help incentivise reuse and recycling. Public co-ordination and financial support for recycling infrastructure is also important to improve collection, sorting and recycling. Governments could also develop programmes to increase co-ordination along supply chains, such as publicly available material registries to connect potential suppliers with users of materials for reuse.

R&D support would also be useful to expand options to recycle materials for which cost-efficient methods are not already readily available. Policymakers should also facilitate the efficient collection and transport of spent EV batteries, foster product design and labelling to help streamline the recycling process, and harmonise regulations on international movement of batteries (IEA, 2021c). The European Union is a leader in this area.

Box 6.14 Case study: Incentivising the circular economy of battery supply chains in the European Union

Within the framework of the European Green Deal and Circular Economy Action Plan, the European Commission has issued a legislative proposal that would set mandatory requirements for all batteries to minimise environmental effects along the supply chain and encourage greater recycling. Among other things, the regulation will:

- Introduce carbon footprint and material content labelling requirements for all batteries sold in the European Union through a digital battery passport.
- Establish minimum recycled content requirements for cobalt (16%), lead (85%), lithium (6%) and nickel (6%).
- Set collection rate targets for EV batteries and eliminate collection charges for end users, as 61% of batteries will have to be collected for recycling by 2031.
- Require economic operators selling batteries (including automotive OEMs) to establish supply chain due diligence obligations for responsible raw material sourcing.

While the regulation reached provisional political agreement in December 2022, more details have yet to be published.

Adopt standards for clean technologies and traceability

Technical regulations are essential to ensure the safe and sustainable deployment of clean energy technologies and their supply chains, as well as lower costs. Standards can be used to establish a common set of criteria and metrics to assess a large array of clean technology supply chains. Standardisation efforts are typically led by third-party organisations to facilitate communication, collaboration and certification, but governments can promote or require the use of standards that increase the supply chain transparency of clean energy technologies through regulations and working with industry.

Developing taxonomies and definitions for low- and zero emission products and materials will be particularly important for clean technology supply chains to determine which technologies and practices are deemed acceptable. They can be used directly by the public sector or serve as guidance for the private sector, notably in sustainable financing. For example, the IEA has proposed definitions for near zero emission steel and cement production (IEA, 2022j). The low-carbon fuel standards pioneered by the California Air Resources Board are based on a detailed set of values for the GHG emissions associated with different types of energy (Box 6.13).

Governments can also require the use of traceability standards in public procurement tenders or trade regulations as a first step in promoting transparency in clean technology supply chains. They can incorporate carbon-footprint requirements for technologies such as EV batteries or heat pumps, and for fuels such as low-emission hydrogen. Agreeing on an international methodology for calculating carbon footprints is essential but will be far from easy, as the methodology would need to be underpinned by broad scientific consensus while incorporating regular improvements in data collection. The process could build on existing work, however, such as the principles and frameworks for lifecycle assessment developed by the International Standards Organization (ISO, 2022).

Traceability standards can also include content-origin stipulations to better manage and promote fair labour practices and protect against human rights abuses. Such standards can be applied to all steps of clean energy supply chains, providing useful information for plant operators and consumers to decide what technology/equipment to purchase depending on how the constituent materials were produced and/or the technology was manufactured. Governments can leverage existing traceability work done for solar PV supply chains, such as the Solar Supply Chain Traceability Protocol, and for REE supplies, such as that carried out by the ISO (Table 6.5). One of the traceability standards for EV batteries is the battery passport being developed by the Global Battery Alliance (Box 6.15).

Benefits of regional and (when feasible) international harmonisation extend beyond traceability standards; regulations, taxonomies and definitions applicable across multiple jurisdictions can lend clarity and consistency that are appreciated by financier and private enterprise alike. One example of such a globally harmonised approach is the UNECE's World Forum for Harmonization of Vehicle Regulation, wherein governments representing more than 90% of global road vehicle production discuss and agree upon globally unified technical policies including regulations and other instruments relating to pollution, safety, security and technical standards for the automotive sector.

Global target-setting, as well as consensus on taxonomies and definitions, will be particularly important in international sectors such as (non-domestic) aviation and maritime shipping. In these sectors, GHG emissions are not accounted to any particular country or supraregional block, but rather fall under the jurisdiction of the United Nations' International Civil Aviation Organisation (ICAO) and International Maritime Organisation (IMO). While these organisations have faced challenges in achieving consensus on sufficiently ambitious targets, as well as the regulations that would be needed to make them credible, increased scrutiny from civil society, financing groups and ambitious public and private sector actors can be instrumental to both raise targets and ensure that the frameworks adopted are effective.

Box 6.15 Case study: Supporting sustainable battery value chains by 2030 and the battery passport

The Global Battery Alliance (GBA) report “A Vision for a Sustainable Battery Value Chain in 2030” highlights the economic, environmental and energy access opportunities that could emerge from a transition to a more sustainable battery value chain. The 2019 projections include lifecycle cost reductions of up to 23%, which could result in 10 million jobs and generate USD 150 billion in economic value worldwide by 2030. Based on the rapid market adoption of EVs since that time, the GBA and McKinsey have substantially increased the job growth and economic value projections across the entire lithium-ion battery value chain. A report documenting their updated projections will be released in early 2023.

Increasing the uptake of sustainable batteries hinges on the creation of a circular battery value chain that creates economic opportunities and protects human rights. This also presents opportunities for substantial emission reductions, including a reduction of up to 90% material and manufacturing emissions reduction per kWh in the lifecycle emissions at the cell level by 2030. To this end, in 2020 the GBA agreed on ten guiding principles, which have been agreed to by over 100 public and private bodies, including foundations, government agencies, mining enterprises, automotive, chemical and cell manufacturers, and energy companies.

As a key action area, the GBA proposed the “Battery Passport” to make battery value chains more sustainable, circular and responsible by establishing a digital twin of a physical battery in EVs. The passport aims to increase transparency in the global battery value chain by collecting, exchanging, collating and reporting data among stakeholders. The goal is to provide end-users with key information about a battery’s material origin, chemical make-up, manufacturing history and sustainability performance. As part of this effort, the GBA released a Greenhouse Gas Rulebook for calculating and tracking the GHG footprint of EV batteries to enable consumers to make more responsible purchasing decisions and drive the industry toward sustainable sourcing practices. The rulebook will create a framework for benchmarking batteries against the GBA’s verifiable definition of a sustainable and responsible battery. The first battery passport is scheduled to be launched by the GBA in January 2023.

Another key initiative of the GBA is the Critical Minerals Advisory Group, which is working to build consensus on key priorities, coordinating policy development, and developing long term circularity strategies and an industry wide roadmap for the battery value chain.

Source: GBA (2023).

Table 6.5 Traceability standards, protocols and initiatives

Standard	Category	Description	Scope
Solar Supply Chain Traceability Protocol	LP	A set of recommended policies and procedures designed to identify the source of a product's material inputs and trace the movement of these inputs throughout the supply chain	United States
UN Global Compact	LP, ES	A principle-based framework for corporate social and environmental responsibility	Global
ISO 23664:2021 Traceability of rare earths in the supply chain, from mine to separate products	ES	Specifies the information to be recorded by supply chain businesses for REEs or products, from mine to separate products	Global
Directive on corporate sustainability due diligence	LP, ES	Due-diligence rules that require member states to identify and, when necessary, prevent, end or mitigate adverse impacts of their value chain activities on human rights and the environment	European Union
Global Battery Passport	LP, ES	The Global Battery Alliance will launch the Global Battery Passport – a data source on battery provenance – in January 2023	Global
OECD's Due Diligence Guidance for Responsible Supply Chains	LP	Detailed recommendations to help companies address human rights issues and avoid contributing to conflict through their mineral-purchasing decisions and practices	Global
Initiative for Responsible Mining Assurance	LP, ES	Defines good practices for responsible mining, providing a list of expectations that independent auditors will use as the benchmark for responsible mines	Global
Responsible Minerals Initiative	LP	Member-based initiative that provides guidance and audits to companies on responsibly sourced minerals based on international standards	Global
Extractive Industries Transparency Initiative	Governance	Requires transparency along the extractive industry value chain governing what should be disclosed and when	Global
Energy Resource Governance Initiative	LP, ES	Designed to promote sound mining sector governance and resilient energy mineral supply chains through the sharing of best practices	Global
Environmental product declarations	ES	Quantifies environmental information on the lifecycle of a product to enable comparisons between products fulfilling the same function	Global
The Greenhouse Gas Protocol	ES	Establishes a standardised framework to measure and manage GHG emissions from operations and value chains	Global
Global Reporting Initiative	LP, ES	GRI Standards provide a framework for company sustainability reporting	Global

Notes: LP = labour practice; ES = environmental sustainability; GHG = greenhouse gas.

Consider ESG regulations

There is a growing need to improve ESG in clean energy supply chains, particularly in mining and processing. Failure to anticipate and address ESG risks early on could lead to supply disruptions, which could slow the pace of energy transitions. For instance, substandard practices could lead to negative public perception of a given clean energy sector and perhaps also a retroactive tightening of environmental or labour standards, which should be a prerequisite in the first place – this may lead to interruptions in operations.

Although identifying and addressing risks across jurisdictions with a patchwork of legal frameworks and local contexts is technically challenging and resource-intensive, ignoring ESG supply chain risks can be increasingly costly in light of pressure from consumers, investors and regulators to eliminate corrupt and socially unacceptable practices in their supply chains (IEA, 2021c). If a company's strong ESG performance is rewarded in the marketplace, other companies will see an incentive to address ESG concerns. Corruption and bribery pose major liability risks for companies, but they can be managed with adequate supply chain due-diligence practices.

Policymakers can promote ESG through co-ordinated policy efforts in providing technical and political support to countries seeking to improve legal and regulatory practices, incentivising producers to adopt more sustainable operational practices and ensuring that companies undertake due diligence to identify, assess and mitigate risks. The European Union has recently been adopting regulations targeting ESG considerations, including a ban on products made with forced labour and the Carbon Border Adjustment Mechanism, which is a key element of the European Union's Fit for 55 package (Box 6.16). A new regulation focusing on EV battery value chains, which is expected to mandate minimum standards of trade flow transparency, responsible sourcing, and material recovery and recycling, has been proposed.

Governments can encourage or require stricter disclosure and due-diligence requirements through financial regulations, drawing on the OECD's Due Diligence Guidance for Responsible Supply Chains (OECD, 2016). This document provides detailed recommendations for companies sourcing minerals or metals, including tin, tantalum, tungsten and gold, from conflict-affected and other high-risk zones. This framework can also be applied to cobalt, copper and lithium – key mineral inputs for clean energy technologies to reduce risks associated with conflict as well as corruption, labour practices and the environment.

Box 6.16 Case study: The shifting focus of EU climate policy on supply chains

The European Union has put in place a set of measures over the past few years to achieve its pledge of reaching net zero GHG emissions by 2050, including the European Green Deal, the EU Taxonomy and the Fit for 55 package (a set of revisions and updates of EU legislation as well as new initiatives to meet the target of reducing GHG emissions by 55% by 2030). A crucial element of Fit for 55 is the Carbon Border Adjustment Mechanism (CBAM), which is intended to tax the most carbon-intensive imports – aluminium, cement, electricity, fertilisers, and iron and steel – from countries that do not price CO₂ emissions to the extent that the European Union does. European producers subject to the EU Emissions Trading System (EU ETS) are considered to be at a competitive disadvantage to external producers, resulting in carbon leakage – a shift in carbon-intensive production to countries with less stringent climate policies. The CBAM will gradually replace previous measures used to address leakage, most notably the free allocation of EU ETS allowances. These allowances will be gradually phased out as the CBAM comes into effect, with the CBAM effectively mirroring the EU ETS for non-EU producers. In the future, the CBAM is expected to be extended to other energy-intensive sectors. The European Council aims to formally adopt CBAM only once relevant elements in other dossiers (such as the EU ETS) are resolved. Under the current provisional agreement, the CBAM will initially only oblige data reporting, and will become operational starting in October 2023.

The European Commission is also showing willingness to regulate social and governance issues, in addition to environmental ones. In February 2022, it proposed a directive on corporate sustainability due diligence, and more recently a prohibition on the sale of products made with forced labour on the EU market, regardless of whether they are produced in Europe or are imported. Authorities in EU member states would be tasked with implementing the ban, but the Commission would help them assess which goods fall into this category based on submissions from civil society organisations, a global database on such risks in certain supply chains and geographies, and corporate due-diligence reporting. A new EU Forced Labour Product Network will support such efforts. In investigating potential cases, national authorities will rely on principles of risk-based assessment and proportionality. The proposal is due to be considered by the European Parliament and Council; if it becomes law, it will enter into force after two years.

Support near zero emission material production

Governments can help make materials produced with low or near zero emissions more widely available and more affordable, thus smoothing the way for their use in clean energy technologies and infrastructure. Since production technologies for near zero emission materials are not yet commercially available in many cases,

and since production costs are likely to be higher than for conventional routes, government support will be important for commercialisation and early deployment, and to help bridge the longer-term remaining cost gap. Here, supply-push and demand-pull policies can play complementary roles, reinforced by international co-operation to overcome challenges related to international competitiveness.

Supply-push policies are critical to get technologies to the market and to overcome the financial constraints inherent in building large-scale, capital-intensive projects. Examples include programmes to fund and share knowledge among R&D and demonstration projects; financing measures to overcome the higher risks of early projects; and co-ordination and incentives to expand supporting infrastructure.

Meanwhile, demand-pull policies help give producers confidence that they will be able to sell materials produced with low or near zero emissions, despite their likely higher costs, thus solidifying the business case. While private sector procurement can help with this (discussed above), public policies will be important to strengthen demand signals. In the earliest stages of technology deployment, targeted policies providing direct support will be important. For example, carbon contracts for difference subsidise the cost gap with conventional material production, allowing producers to sell on conventional markets.

For subsequent rollout, other policies can help with market creation, including public procurement, co-ordination of private sector buying pools, near zero emission material production mandates (formulated like zero emission vehicle mandates, for example), and lifecycle-based emission standards for final products or construction projects. In the longer term, once wider-spread production and innovation have lowered costs and reduced risks, carbon pricing may be sufficient to sustain the continued rollout of near zero emission material production.

Public procurement as a demand-creation mechanism is gaining popularity to support the use of near zero emission materials (see Box 6.17). This could help directly decarbonise clean energy supply chains if low-carbon content requirements are applied to government-funded energy-related infrastructure projects, or otherwise provide a demand signal to scale up supply more broadly. For example, the CEM's Industrial Deep Decarbonisation Initiative (IDDI) aggregates public sector procurement of near zero emission steel and concrete to send a clear market signal to producers (UNIDO, 2021). To illustrate the scale of impact, IDDI now covers approximately 70-110 Mt of total steel demand, equal to around 5% of the global market. Governments can use public tenders or competitive solicitations that balance price with specific criteria such as carbon content. They could include emissions criteria in bidding-price calculations, or targets for embodied carbon or shares of materials in the tender. Targets set for several years in advance would best stimulate innovation and reduce investment risks for technology providers and manufacturers.

Measures to address the international competitiveness of near zero emission material production will also be important. Options may include international sectoral agreements or clubs, or policies such as carbon-based border adjustments. International financing, capacity-building and technology co-development can help ease the challenge by facilitating higher ambition globally on industry emissions reductions. For further discussion on push, pull and international competitiveness policies for stimulating low- and near zero emission material production, see the IEA report *Achieving Net Zero Heavy Industry Sectors in G7 Members* (IEA, 2022j).

Box 6.17 Case study: Incentivising clean construction materials in the United States

The Federal Buy Clean Initiative aims to prioritise the use of domestically made low-carbon construction materials in federal procurement and federally funded projects. In addition to funding from the Infrastructure Investment and Jobs Act, the Inflation Reduction Act provides USD 4.5 billion to federal agencies to identify and use materials and products that produce substantially lower GHG emissions.

In September 2022, the United States announced new actions under this initiative to prioritise the purchase of key low-carbon construction materials, covering 98% of materials purchased by the federal government. It intends to:

- Prioritise the government's purchasing of steel, concrete, asphalt and flat glass that have fewer embodied emissions.
- Expand the inclusion of low-carbon construction materials to federally funded projects, such as infrastructure projects.
- Convene state governments to establish partnerships.
- Increase data transparency through supplier reporting to help manufacturers track and reduce emissions.
- Launch pilot programmes in partnership with regional contractors to advance federal procurement of clean construction materials.

Source: The White House (2022c).

References

- Alberta, Ministry of Energy (2021), Renewing Alberta's Mineral Future, <https://open.alberta.ca/dataset/9d147a23-cb06-413d-a60e-ad2d7fe4e682/resource/73ebd14b-a687-4772-9982-48843b677c28/download/energy-renewing-albertas-mineral-future-report-2021.pdf>
- Australia, Department of Industry, Science and Resources (2020), Make it Happen: The Australian Government's Modern Manufacturing Strategy, <https://www.industry.gov.au/data-and-publications/make-it-happen-the-australian-governments-modern-manufacturing-strategy>
- Bhasin, S., A. Gorthi and V. Chaturvedi (2020), A Universal Certification System for India's Refrigeration and Air-Conditioning Servicing Sector, <https://www.ceew.in/sites/default/files/ceew-study-on-universal-certification-for-indias-ac-sector-16Jul20.pdf>
- Bloomberg (2022), Commodities, <https://www.bloomberg.com/markets/commodities>
- BloombergNEF (2021), Wind Manufacturing and Trade: A Deep Dive.
- BloombergNEF (2020), Global Nickel Outlook 2020-2030.
- Branford, Z. and J. Roberts (2022), The installer skills gap in the UK heat pump sector and the impacts on a just transition to net-zero, University of Strathclyde, https://pure.strath.ac.uk/ws/portalfiles/portal/133553551/Branford_2022_Executive_summary_heat_pump_skills_gap_and_the_just_transition.pdf
- Business Standard (2021), What is PLI for? https://www.business-standard.com/article/opinion/what-is-pli-for-121102001572_1.html
- CARB (California Air Resources Board) (2022), LCFS Data Dashboard, <https://ww2.arb.ca.gov/resources/documents/lcfs-data-dashboard> (accessed October 2022).
- Chinalawinfo (2022), Provisions on the Administration of Certified Constructors [Revised], <http://www.lawinfochina.com/display.aspx?lib=law&id=5822&CGid=>
- CAAM (China Association of Automobile Manufacturers) (2021), Electric Vehicle Safety Guide, <http://file.caam.org.cn/2021/12/1640229989024094298.pdf>
- Cetinkaya E., Dincer, I., and G.F. Naterer (2012), Life cycle assessment of various hydrogen production methods, International Journal of Hydrogen Energy, 37(3), 2071-2050, <https://doi.org/10.1016/j.ijhydene.2011.10.064>
- China, NEA (National Energy Administration) (2022), Questions and Answers on Household Photovoltaic Construction and Operation (2022 Edition), http://www.nea.gov.cn/2022-08/31/c_1310657941.htm
- China Southern Power Grid (2022), China Southern Power Grid website, <https://shoudian.bjx.com.cn/>
- CPH2 (Clean Power Hydrogen) (2022), CPH2 website, <https://www.cph2.com/>
- d'Estries, M. (2021), How to Become a Wind Turbine Technician: Training, Timing and More, SkillPointe, 5 August, <https://skillpointe.com/news-and-advice/how-become-wind-turbine-technician-training-timing-and-more>
- Deutz S. and A. Bardow (2021), Life-cycle assessment of an industrial direct air capture process based on temperature–vacuum swing adsorption, Nature Energy, 6(2), 203-213, [10.1038/s41560-020-00771-9](https://doi.org/10.1038/s41560-020-00771-9)

- EC (European Commission) (2022a), REPowerEU: Affordable, secure and sustainable energy for Europe, https://ec.europa.eu/info/strategy/priorities-2019-2024/european-green-deal/repowereu-affordable-secure-and-sustainable-energy-europe_en
- EC (2022b), Addressing the sustainability and criticality of electrolyser and fuel cell materials, <https://ec.europa.eu/info/funding-tenders/opportunities/portal/screen/opportunities/topic-details/horizon-jti-cleanh2-2022-07-01;callCode=null;freeTextSearchKeyword=;matchWholeText=true;typeCodes=1,2;statusCodes=31094501;programmePeriod=null;programCcm2Id=null;programDivisionCode=null;focusAreaCode=null;destination=null;mission=null;geographicalZonesCode=null;programmeDivisionProspect=null;startDateLte=null;startDateGte=null;crossCuttingPriorityCode=null;cpvCode=null;performanceOfDelivery=null;sortQuery=startDate;orderBy=desc;onlyTenders=false;topicListKey=topicSearchTablePageState>
- EC (2022c), Ecodesign for sustainable products, https://ec.europa.eu/info/energy-climate-change-environment/standards-tools-and-labels/products-labelling-rules-and-requirements/sustainable-products/ecodesign-sustainable-products_en
- EC (2021a), Horizon Europe, budget: Horizon Europe - The most ambitious EU research & innovation programme ever, <https://op.europa.eu/en/publication-detail/-/publication/1f107d76-acbe-11eb-9767-01aa75ed71a1>
- EC (2021b), Innovation Fund (InnovFund) Call for proposals Annex B: Methodology for Relevant Costs calculation, https://ec.europa.eu/info/funding-tenders/opportunities/docs/2021-2027/innovfund/wp-call/2021/call-annex_b_innovfund-lsc-2021_en.pdf
- EC (2021c), Study on the Resilience of Critical Supply Chains for Energy Security and Clean Energy Transition During and After the COVID-19 Crisis, <https://op.europa.eu/en/publication-detail/-/publication/b80d77b6-2a3b-11ec-bd8e-01aa75ed71a1/language-en>
- EC (2020), Critical Raw Materials Resilience: Charting a Path towards greater Security and Sustainability, <https://ec.europa.eu/docsroom/documents/42849>
- EC (n.d.), European Chips Act, https://commission.europa.eu/strategy-and-policy/priorities-2019-2024/europe-fit-digital-age/european-chips-act_en
- EIF (European Investment Fund) (2022), Climate & Infrastructure Funds, <https://engage.eif.org/investeu/climate-infrastructure-funds>
- EIF (2021), Climate & Infrastructure Funds, https://www.eif.org/what_we_do/equity/climate-and-infrastructure-funds/index.htm
- ERA Portal Austria (2022), EU Innovation Fund invests € 1.8 billion in 17 large-scale innovative clean-tech projects, <https://era.gv.at/news-items/eu-innovation-fund-invests-18-billion-in-17-large-scale-innovative-clean-tech-projects/>
- ETIPWind (European Technology & Innovation Platform on Wind Energy) (2013), Workers Wanted: The EU Wind Energy Sector Skills Gap, <https://etipwind.eu/files/reports/TPWind-Workers-Wanted.pdf>
- EV Volumes (2022), Global EV Sales for 2022 H1, <https://www.ev-volumes.com/>
- Export Finance Australia (2022), Transforming Australia's critical minerals sector, <https://www.exportfinance.gov.au/newsroom/transforming-australia-s-critical-minerals-sector/>
- Export Finance Australia (2021), Critical Minerals, <https://www.exportfinance.gov.au/criticalminerals/>

- GBA (Global Battery Alliance) (2023), Greenhouse Gas Rulebook, <https://www.globalbattery.org/press-releases/launch-of-greenhouse-gas-rulebook/>
- Gerloff N. (2021), Comparative Life-Cycle-Assessment analysis of three major water electrolysis technologies while applying various energy scenarios for a greener hydrogen production, *Journal of Energy Storage*, 43, 102759, <https://doi.org/10.1016/j.est.2021.102759>
- GSA (US General Services Administration) (2022), GSA lightens the environmental footprint of its building materials, <https://www.gsa.gov/about-us/newsroom/news-releases/gsa-lightens-the-environmental-footprint-of-its-building-materials-03302022>
- H2 Green Steel (2022), H2 Green Steel has pre-sold over 1.5 million tonnes of green steel to customers, <https://www.h2greensteel.com/latestnews/h2-green-steel-has-pre-sold-over-15-million-tonnes-of-green-steel-to-customers>
- H2U Technologies (2022), H2U Technologies website, <https://www.h2utechnologies.com/technology>
- Heraeus (2022), Heraeus information sheet, https://www.heraeus.com/media/media/hch/media_hch/products_solutions/hydrogen_systems/Heraeus_Brochure_Electrocatalysts_PEM_Electrolyzers.pdf
- Hydrogen Tech World (2022), New tool revolutionizes discovery of non-iridium catalysts for H₂ production, <https://hydrogentechworld.com/new-tool-revolutionizes-discovery-of-non-iridium-catalysts-for-h2-production>
- Hysata (2022), Technology, <https://hysata.com/technology/>
- Hyundai (2020), Hyundai and Kia Turn Up EV Efficiency with New Heat Pump Technology, <https://www.hyundai.news/eu/articles/press-releases/hyundai-and-kia-turn-up-ev-efficiency-with-new-heat-pump-technology.html>
- Iberdrola (2021), Iberdrola and H2 Green Steel sign 2.3 billion euros green hydrogen deal, <https://www.iberdrola.com/press-room/news/detail/deal-green-hydrogen-iberdrola-h2-green-steel>
- ICCT (International Council on Clean Transportation) (2022), Opportunities and Risks for a National Low-Carbon Fuel Standard, <https://theicct.org/wp-content/uploads/2022/03/risks-low-carbon-fuel-standard-mar22.pdf>
- IDB (Inter-American Development Bank) (2013), The Role of National Development Banks in Catalyzing International Climate Finance, <https://publications.iadb.org/publications/english/document/The-Role-of-National-Development-Banks-in-Catalyzing-International-Climate-Finance.pdf>
- IEA (International Energy Agency) (2022a), Securing Clean Energy Technology Supply Chains, <https://www.iea.org/reports/securing-clean-energy-technology-supply-chains>
- IEA (2022b), Solar PV Global Supply Chains, <https://www.iea.org/reports/solar-pv-global-supply-chains>
- IEA (2022c), World Energy Investment 2022, <https://www.iea.org/reports/world-energy-investment-2022>
- IEA (2022d), Global EV Outlook 2022, <https://www.iea.org/reports/global-ev-outlook-2022>
- IEA (2022e), The Need for Net Zero Demonstration Projects, <https://www.iea.org/reports/the-need-for-net-zero-demonstration-projects>
- IEA (2022f), How Governments Support Clean Energy Start-ups, <https://www.iea.org/reports/how-governments-support-clean-energy-start-ups>

- IEA (2022g), 2022 IEA ministerial communiqué, <https://www.iea.org/news/2022-iea-ministerial-communique>
- IEA (2022h), OECD Energy Prices and Taxes quarterly, December 2022 edition, <https://www.iea.org/data-and-statistics/data-product/oecd-energy-prices-and-taxes-quarterly>
- IEA (2022i), Global Hydrogen Review 2022, <https://www.iea.org/reports/global-hydrogen-review-2022>
- IEA (2022j), Achieving Net Zero Heavy Industry Sectors in G7 Members, <https://www.iea.org/reports/achieving-net-zero-heavy-industry-sectors-in-g7-members>
- IEA (2021a), Recommendations of the Global Commission on People-Centred Clean Energy Transitions, <https://www.iea.org/reports/recommendations-of-the-global-commission-on-people-centred-clean-energy-transitions>
- IEA (2021b), Ammonia Technology Roadmap, <https://www.iea.org/reports/ammonia-technology-roadmap>
- IEA (2021c), The Role of Critical Minerals in Clean Energy Transitions, <https://www.iea.org/reports/the-role-of-critical-minerals-in-clean-energy-transitions>
- IEA (2020a), Energy Technology Perspectives 2020, <https://www.iea.org/reports/energy-technology-perspectives-2020>
- IEA (2020b), Iron and Steel Technology Roadmap, <https://www.iea.org/reports/iron-and-steel-technology-roadmap>
- IEA (2019), Material Efficiency in Clean Energy Transitions, <https://www.iea.org/reports/material-efficiency-in-clean-energy-transitions>
- IMI (Institute of the Motor Industry) (2018), Electric Vehicle Maintenance Standards, <https://www.theimi.org.uk/sites/default/files/documents/536776.pdf>
- India, Ministry of Heavy Industries (2022), Three Companies signed Program Agreement under (PLI) Scheme for Advanced Chemistry Cell (ACC) Battery Storage, <https://pib.gov.in/PressReleasePage.aspx?PRID=1846078>
- India, Ministry of Heavy Industries (2021), Cabinet approves Production Linked Incentive scheme “National Programme on Advanced Chemistry Cell Battery Storage”, <https://pib.gov.in/pressreleasepage.aspx?prid=1717943>
- India, MNRE (Ministry of New and Renewable Energy) (2019), Guidelines for Development of Decentralised Solar Power Plants, https://mnre.gov.in/img/documents/uploads/file_f-1580894745068.pdf
- India, National Qualifications Register (2021), Qualification Details: O&M Mechanical Technician – Wind Power Plant, <https://www.nqr.gov.in/qualification-title?nid=5947>
- Invest India (n.d.) Production Linked Incentive (PLI) Schemes in India <https://www.investindia.gov.in/production-linked-incentives-schemes-india>
- ISO (International Standards Organization) (2022), ISO 14040:2006 Environmental management – Life cycle assessment – Principles and framework, <https://www.iso.org/standard/37456.html>
- Japan, METI (Ministry of Economy, Trade and Industry) (2021), Asia Energy Transition Initiative (AETI), https://www.meti.go.jp/english/press/2021/pdf/20210528001_aetieng.pdf

- Kiemel, S. et al. (2021) Critical materials for water electrolyzers at the example of the energy transition in Germany, *International Journal of Energy Research* 45, pp. 9914-9935, <https://doi.org/10.1002/er.6487>
- Koornneef, J. et al. (2008) Life cycle assessment of a pulverized coal power plant with post-combustion capture, transport and storage of CO₂, *International Journal of Greenhouse Gas Control*, 2 (4), 448-467, <https://doi.org/10.1016/j.ijggc.2008.06.008>
- MCS (2022), Becoming certified, <https://mcscertified.com/installers-manufacturers/becoming-certified/>
- National Careers Service (2022), Wind turbine technician, <https://nationalcareers.service.gov.uk/job-profiles/wind-turbine-technician#:~:text=Entry%20requirements-.You'll%20usually%20need%3A,a%20higher%20or%20degree%20apprenticeship>
- National Law Review (2022), Reduce, Reuse, Recycle, Repair? Current and Future Right-To-Repair Rules in the European Union and United Kingdom, <https://www.natlawreview.com/article/reduce-reuse-recycle-repair-current-and-future-right-to-repair-rules-european-union>
- Nesta (2022), Shortage of trained heat pump installers could set back net zero, <https://www.nesta.org.uk/press-release/shortage-of-trained-heat-pump-installers-could-set-back-net-zero/>
- Norman, A. and N.O. Regan (2022), Installing for time, <https://www.smf.co.uk/wp-content/uploads/2022/02/Installing-for-time-Jan-2022.pdf>
- NREL (National Renewable Energy Laboratory) (2021), Machine Learning Method Could Speed the Search for New Battery Materials, <https://www.nrel.gov/news/program/2021/machine-learning-method-could-speed-the-search-for-new-battery-materials.html>
- NREL (2001) Life Cycle Assessment of Hydrogen Production via Natural Gas Steam Reforming, <https://www.nrel.gov/docs/fy01osti/27637.pdf>
- NSTA (North Sea Transition Authority) (2022), New tool to maximise infrastructure repurposing, <https://www.nstauthority.co.uk/news-publications/news/2022/new-tool-to-maximise-infrastructure-repurposing/>
- OECD (Organisation for Economic Co-operation and Development) (2022), Gross domestic expenditure on R&D by sector of performance and socio-economic objective (SEO), <https://stats.oecd.org/>
- OECD (2016), Due Diligence Guidance for Responsible Supply Chains of Minerals from Conflict-Affected and High-Risk Areas: Third Edition, <https://www.oecd.org/corporate/mne/mining.htm>
- Pehnt M. and J. Henkel (2009), Life cycle assessment of carbon dioxide capture and storage from lignite power plants, *International Journal of Greenhouse Gas Control*, 3 (1), 49-66, <https://doi.org/10.1016/j.ijggc.2008.07.001>
- RSI (The Refrigeration School Inc.) (2022), Solar Certification and Licensing Requirements by State, <https://www.rsi.edu/blog/solar/solar-certification-and-licensing-requirements-by-state/>
- S&P Global (2022a), Lithium and cobalt global supply-demand balance, January 2022.

- S&P Global (2022b), Renascor, EcoGraf secure loans under Australia's A\$2B Critical Minerals Facility, <https://www.spglobal.com/marketintelligence/en/news-insights/latest-news-headlines/renascor-ecograf-secure-loans-under-australia-s-a-2b-critical-minerals-facility-68692354>
- S&P Global (2022c), Unpacking ammonia's market landscape and its role in the energy transition, <https://www.spglobal.com/commodityinsights/en/market-insights/blogs/energy-transition/091622-ammonia-prices-supply-demand-hydrogen-power-bunker-fuel>
- S&P Global (2022d), Commodity Prices.
- SEIA (Solar Energy Industries Association) (2019), The Adverse Impact of Section 201 Tariffs: Lost Jobs, Lost Deployment and Lost Investments, https://www.seia.org/sites/default/files/2019-12/SEIA-Tariff-Analysis-Report-2019-12-3-Digital_0.pdf
- Shanghai Petroleum and Gas Exchange (2022), China LNG Factory Price National Index, <https://www.shpgx.com/html/ChnLNGIndexHistory.html>
- SSAB (2018), SmartSteel 1.0 – The first step toward an internet of materials, <https://www.ssab.com/en/news/2018/05/smartsteel-10--the-first-step-toward-an-internet-of-materials>
- Star Refrigeration (n.d.), Star Refrigeration website, <https://www.star-ref.co.uk/>
- State Grid Corporation of China (2022), [In December 2022, power grid enterprises across the country will announce the agency power purchase price], <https://news.bjx.com.cn/html/20221128/1272342.shtml>
- Sunfire (2022), Alkaline electrolysis scaling is picking up speed: Sunfire acquires electroplating specialist, <https://www.sunfire.de/en/news/detail/alkaline-electrolysis-scaling-is-picking-up-speed-sunfire-acquires-electroplating-specialist>
- The Hindu (2022), Delhi government to launch training programme for EV mechanics, <https://www.thehindu.com/news/cities/Delhi/delhi-government-to-launch-training-programme-for-ev-mechanics/article65898443.ece>
- The White House (2022a), Biden-Harris Administration Bringing Semiconductor Manufacturing Back to America, <https://www.whitehouse.gov/briefing-room/statements-releases/2022/01/21/fact-sheet-biden-harris-administration-bringing-semiconductor-manufacturing-back-to-america-2/>
- The White House (2022b), President Biden's Economic Plan Drives America's Electric Vehicle Manufacturing Boom, <https://www.whitehouse.gov/briefing-room/statements-releases/2022/09/14/fact-sheet-president-bidens-economic-plan-drives-americas-electric-vehicle-manufacturing-boom/>
- The White House (2022c), Biden-Harris Administration Announces New Buy Clean Actions to Ensure American Manufacturing Leads in the 21st Century, <https://www.whitehouse.gov/briefing-room/statements-releases/2022/09/15/fact-sheet-biden-harris-administration-announces-new-buy-clean-actions-to-ensure-american-manufacturing-leads-in-the-21st-century/>
- UNEP (United Nations Environment Programme) (2015), National Certification Schemes for Refrigeration and Air-Conditioning Service Technicians, https://wedocs.unep.org/bitstream/handle/20.500.11822/26717/7756UNEP_ASHRAE_EN.pdf?sequence=1&isAllowed=y

- UNIDO (United Nations Industrial Development Organization) (2021), World's largest steel and concrete buyers make game-changing push for greener solutions, <https://www.unido.org/news/worlds-largest-steel-and-concrete-buyers-make-game-changing-push-greener-solutions>
- United Kingdom, BEIS (Department for Business, Energy & Industrial Strategy) (2021), North Sea Transition Deal, https://assets.publishing.service.gov.uk/government/uploads/system/uploads/attachment_data/file/972520/north-sea-transition-deal_A_FINAL.pdf
- United States, BLS (US Bureau of Labor Statistics) (2022), Careers in Electric Vehicles, https://www.bls.gov/green/electric_vehicles/
- United States, DOE (2022a), Wind Energy Education and Training Programs, <https://windexchange.energy.gov/training-programs>
- United States, DOE (Department of Energy) (2022b), America's Strategy to Secure the Supply Chain for a Robust Clean Energy Transition, https://www.energy.gov/sites/default/files/2022-02/America%E2%80%99s%20Strategy%20to%20Secure%20the%20Supply%20Chain%20for%20a%20Robust%20Clean%20Energy%20Transition%20FINAL.docx_0.pdf
- United States, DOE (2022c), DOE Optimizes Structure to Implement \$62 Billion in Clean Energy Investments From Bipartisan Infrastructure Law, <https://www.energy.gov/articles/doe-optimizes-structure-implement-62-billion-clean-energy-investments-bipartisan>
- United States, DOE (2022d), United States Hosts First Ever Global Clean Energy Action Forum to Accelerate Clean Energy Innovation and Deployment, Fact sheet, https://www.energy.gov/sites/default/files/2022-09/USG%20GCEAF%20FACTSHEET_final_1.pdf
- United States, DOE (2022e), United States Energy and Employment Report 2022, https://www.energy.gov/sites/default/files/2022-06/USEER%202022%20National%20Report_1.pdf
- United States, DOE (2022f), Production Tax Credit and Investment Tax Credit for Wind Energy, <https://windexchange.energy.gov/projects/tax-credits>
- United States, DOE (2022g), Investigating Benefits and Challenges of Converting Retiring Plants into Nuclear Plants, <https://www.osti.gov/biblio/1886660>
- United States, DOE (2021), Fuels, United States Energy and Employment Report, <https://www.energy.gov/sites/default/files/2021-07/USEER%202021%20Main%20Body.pdf>
- United States, DOS (Department of State) (2022), Secretary Blinken at an MOU Signing with Democratic Republic of the Congo Vice Prime Minister and Foreign Minister Christophe Lutundula and Zambian Foreign Minister Stanley Kakubo, https://www.state.gov/secretary-blinken-at-an-mou-signing-with-democratic-republic-of-the-congo-vice-prime-minister-and-foreign-minister-christophe-lutundula-and-zambian-foreign-minister-stanley-kakubo/?utm_source=newsletter&utm_medium=email&utm_campaign=newsletter_axio_sgenerate&stream=top
- USGS (United States Geological Survey) (2022), Mineral Commodity Summaries 2022, <https://pubs.usgs.gov/periodicals/mcs2022/mcs2022.pdf>
- Western Australia, Department of Mines, Industry Regulation and Safety (2019), Lithium royalty amendments to encourage downstream processing, <https://dmp.wa.gov.au/News/Lithium-royalty-amendments-to-25938.aspx>

Wood Mackenzie (2022), Wind turbine blades supply chain trends 2022, Global Wind Energy Supply Chain Series, <https://www.woodmac.com/reports/power-markets-global-wind-supply-chain-trends-series-article-2-wind-turbine-blades-supply-chain-trends-150060824/>

World Bureau of Metal Statistics (2022), Mineral Yearbook.

World Resource Institute (2022), Direct Air Capture: Assessing Impacts to Enable Responsible Scaling, <https://www.wri.org/research/direct-air-capture-impacts>

Worldsteel (2022), Steel Statistical Yearbook, <https://worldsteel.org/steel-by-topic/statistics/steel-statistical-yearbook/>

Yeh, S. et al. (2016), A review of low carbon fuel policies: Principles, program status and future directions, Energy Policy, 97, 220-234, <https://doi.org/10.1016/j.enpol.2016.07.029>

Annex

Glossary

Announced Pledges Scenario (APS): This scenario assumes that governments will meet, in full and on time, all of the climate-related commitments that they have announced, including longer-term net zero emission targets and pledges in Nationally Determined Contributions, as well as commitments in related areas such as energy access. It does so irrespective of whether or not those commitments are underpinned by specific policies to secure their implementation. Pledges made in international fora and initiatives on the part of businesses and other non-governmental organisations are also taken into account wherever they add to the ambition of governments.

Announced projects/capacity: New facilities or expansions of current facilities as published by manufacturers or producers. The announcements are taken at face value and no judgement is made on their feasibility. They are split between “committed”, those that are currently being built or that have recently received final investment decision; and “preliminary”, those that have been announced and are being planned but have currently not received final investment decision and therefore are more speculative. Some announced values are taken directly from producers or manufacturers, while others are retrieved from specific databases.

Anticipated supply: Potential expected future production based on expert judgement from third party data providers for critical minerals and processed materials. Expectations in commodity prices can have a large impact on the expected supply – a higher price might lead to more supply coming online. At the same time, unexpected delays in financing, permitting, or construction could delay projects, yielding a lower supply. The value is therefore lower than a sum of all announced projects.

Bioenergy with carbon capture (BECC): A suite of technologies involving any energy pathway where CO₂ is captured from a biogenic source including process emissions as well as combustion emissions. When coupled with permanent geological CO₂ storage, BECCS (bioenergy with carbon capture and storage) is a carbon removal technology. As an alternative to storage, the captured CO₂ can also be utilised as a feedstock for a range of products such as synthetic hydrocarbon fuels.

Bulk materials: Large-volume materials produced in quantities approaching or exceeding 100 Mt per year globally. They differ from critical materials in that clean energy transitions are not anticipated to pose a risk of supply gaps, as the raw minerals needed to make them are comparatively widespread and abundant. They are already widely used in energy and other sectors so clean energy transitions are not expected to lead to a large overall increase in total demand. Bulk materials of focus in this report are steel, cement, aluminium and plastic.

Carbon capture, utilisation and storage (CCUS): A suite of technologies capturing CO₂ from large point sources (e.g. power generation or industrial facilities) as well as the air. If not being used on-site, the captured CO₂ is compressed and transported by pipeline, ship, rail or truck to be used in a range of applications, or injected into deep geological formations (including depleted oil and gas reservoirs or saline aquifers), which can trap the CO₂ for permanent storage.

Clean energy technology: Those energy technologies that result in minimal or zero emissions of CO₂ and pollutants. For the purposes of this report, clean energy technology refers to low or near zero emission technologies that do not involve the production or transformation of fossil fuels – coal, oil and natural gas – unless they are accompanied by CCUS and other anti-pollution measures.

Critical materials: Materials that are essential for clean energy technologies and infrastructure whose supply chains are vulnerable to disruption and that could face supply gaps if sufficient efforts are not taken to scale up supply. The volumes of critical materials tend to be small relative to other materials (current global production of each type of critical material is well under 100 Mt per year). Demand from clean energy transitions could drive a very rapid increase in total demand. Critical materials of focus in this report are copper, lithium, nickel, cobalt, neodymium and polysilicon.

Direct air capture (DAC): Technology to capture CO₂ directly from the atmosphere using liquid solvents or solid sorbents. It can be coupled with permanent storage of the CO₂ in deep geological formations or its use in the production of fuels, chemicals, building materials or other products. When coupled with permanent geological CO₂ storage, DACS (DAC with storage) is a carbon removal technology.

End of life: The decommissioning and processing of a piece of physical equipment or infrastructure hardware once it has reached the end of its useful life. This could involve reuse in a second application or recycling, or could involve treatment and disposal.

Energy supply chains: The different steps needed to supply a fuel or final energy service to end-users, usually involving trade of that energy commodity along and across technology supply chains (see also figures I.1 and I.2 of introduction).

Energy technology: The combination of hardware, techniques, skills, methods and processes used in the production of energy and the provision of energy services, i.e. how energy is produced, transformed, stored, transported and used.

Geographical and corporate concentration: Denotes for each of supply chain step of the main technologies how concentrated the existing capacity or announced investment plans are in one or a limited number of countries, regions or corporations (see also Chapter 2 for further analysis).

Infrastructure: The enabling physical facilities and systems that move and store energy or CO₂, linking locations where energy or CO₂ is produced to demand centres, and including storage facilities to balance fluctuations in production and demand, or to permanently store

CO₂. This report focuses on technologies that make up transportation, transmission, distribution, and storage of electricity, hydrogen (or hydrogen-based fuels) and CO₂.

Installation: The on-site deployment of clean technologies, both mass manufactured and site-tailored ones, such as installing a heat pump, deploying wind farms or BECC plants. This includes the project development necessary for the physical deployment, where applicable.

Large-scale, site-tailored technologies: These are usually individually designed and manufactured to fit specific local conditions. They may consist of a number of components that themselves are mass manufactured, but their engineering, assembly and installation are site-specific. Of the supply chains analysed in this report, natural gas-based hydrogen with CCUS, DAC, BECC, and low-emission synthetic hydrocarbon fuels are included in this category.

Lead time: Defined as the time that passes from when a project is announced (i.e. a company states the intent to build a given facility or part of infrastructure) to when the project is commissioned. This includes feasibility studies (except for mining), funding, permitting and actual construction of the project.

Low-emission synthetic hydrocarbon fuels: Synthetic hydrocarbon fuels made from synthesis gas (primarily a mixture of hydrogen, carbon monoxide and CO₂) using catalysts. Suitable feedstocks include electrolytic hydrogen and atmospheric CO₂, captured directly through DAC or indirectly through BECC.

Low-emission hydrogen: Low-emission hydrogen includes hydrogen produced via electrolysis where the electricity is generated from a low-emission energy source (for example, renewables, nuclear, biomass or fossil fuels with CCUS), fossil-based hydrogen production with carbon capture and storage, and biomass-based hydrogen production. The same principle applies to low-emission feedstocks and fuels made using low-emission hydrogen, such as ammonia, or using low-emission hydrogen and a sustainable carbon source (of biogenic origin or directly captured from the atmosphere), such as methanol or other synthetic hydrocarbons.

Manufacturing capacity: The maximum amount of a component or technology a facility is nominally able to produce.

Mass-manufactured technologies: These are assembled in specialised factories in large volumes using several manufactured components and sub-assemblies, with the ready-to-use end product exiting the factory floor. Of the selected supply chains analysed in this report, solar PV modules, wind turbines, electric cars, fuel cell trucks, heat pumps and electrolysers are key technologies that fall into this category.

Material production/mineral processing: The refining, processing or further modifications from the raw mineral into the material which is subsequently used during manufacturing of a technology or component. This may involve extracting a pure metal in elemental form, or processing into a desired alloy or mineral compound.

Material efficiency: A portfolio of measures at all stages of supply chains, each of which serves at least one of several ends: reducing total demand for materials while providing the same service, optimising material use to minimise supply chain pressures, substituting different materials to reduce life-cycle emissions, or in the case of recycling, reducing the need to extract new raw minerals.

Materials: Materials that are produced at industrial plants through refining, processing or further modifications from raw minerals and are used during manufacturing of a technology or component (see also Box 3.1).

Mineral extraction/mining: The extraction of mineral ores from the earth and the upgrading of ores at the mine site to liberate and concentrate the minerals of interest.

Minerals: Naturally occurring rocks or sediments that are extracted from the earth in the form of mineral ores. For the purposes of this report these are measured in terms of the target element contained within mineral ores (see also Box 3.1).

Near zero emission capable production: Material production that achieves substantial greenhouse gas emission reductions, falling short of near zero emissions initially (see definition of “near zero emission material production”) but for which the producer has plans to continue reducing emissions over time such that it could likely later reach near zero emissions without substantial additional capital investments in core process equipment.

Near zero emission material production: Material production with a greenhouse gas emissions intensity that is compatible with net zero emissions for the global energy system. The IEA has proposed definitions for near zero emission steel and cement in the 2022 report *Achieving Net Zero Heavy Industry Sectors in G7 Members*.

Net Zero Emissions by 2050 (NZE) Scenario: The central scenario in this report, a normative scenario that sets out a pathway to the stabilisation of global average temperatures at 1.5°C above pre-industrial levels. The NZE Scenario achieves global net zero CO₂ emissions by 2050 in the energy sector without relying on emissions reductions from outside the energy sector. In doing so, advanced economies reach net zero emissions before developing economies do. The NZE Scenario also meets the key energy-related United Nations Sustainable Development Goals, achieving universal access to modern energy by 2030 and securing major improvements in air quality.

Operation: The use phase of an energy technology resulting in the production of an energy carrier, such as the production of hydrogen by electrolyzers, or the provision of an energy service, such as the mobility by an EV.

Production ramp-up time: The time needed from the production’s start until a facility is able to produce at its full nominal capacity commissioning.

Resilience (of a supply chain): In the context of the report, this refers to the ability of a supply chain to respond and quickly adjust to sudden market shocks on prices or demand. This is particularly influenced by prices being stable and affordable, as well as the supply chain having effective interconnection with other supply chains that can deliver an equivalent technology or service.

Security (of a supply chain): In the context of the report, this refers to the level to which a supply chain has adequate, reliable and uninterrupted supply of inputs. This is particularly influenced by the diversity of the supply chain in terms of market, region, suppliers and technologies.

Sustainability (of a supply chain): In the context of the report, this refers to a supply chain minimising its greenhouse gas emissions and other environmental impacts consistent with climate objectives. This includes supply chain transparency and reporting; strengthening environmental, social and governance measures; and efficient and responsible use of natural resources, including through promotion of material efficiency and end of life stewardship.

Technology and component manufacturing: The production of technologies or components using labour, tools and energy to transform materials into finished goods.

Technology supply chains: The different steps needed to install a clean energy technology, with inputs of materials, components and services involved at each stage (see also figures I.1 and I.2 of introduction).

Utilisation rate: The proportion of the maximum capacity of a facility which is used on average over a set period of time.

Clean supply chain characteristics

Mining and material production

Regional capacities for mining and reserves, 2021

	Copper (kt)		Nickel (kt)		Cobalt (kt)		Lithium (kt)		Rare earth elements (kt)	
	Reserves ^a	Mined ^{b,e}	Reserves ^a	Mined ^c	Reserves ^a	Mined ^d	Reserves ^a	Mined ^d	Reserves ^a	Mined ^a
World	880 000	21 000	95 000	2 700	7 600	150	22 000	100	120 000	290
China	3%	8%	3%	4%	1%	1%	7%	12%	35%	57%
Europe	4%	5%	0%	3%	0%	1%	0%	0%	1%	0%
North America	13%	12%	2%	5%	4%	3%	3%	1%	2%	16%
Other Asia Pacific	13%	11%	49%	66%	30%	13%	36%	56%	26%	24%
Central & South America	32%	41%	17%	10%	7%	3%	42%	29%	17%	0%
Africa	6%	13%	0%	4%	48%	76%	1%	2%	1%	1%
Eurasia	9%	9%	8%	7%	3%	2%	0%	0%	17%	1%
Middle East	0%	2%	0%	0%	0%	0%	0%	0%	0%	0%
Unknown	21%	0%	21%	0%	8%	0%	12%	0%	0%	0%

Notes: World values are rounded to 2 significant figures.

Sources: a. USGS (2022), b. S&P Global (2022a), c. S&P Global (2022b), d. S&P Global (2022c), e. WBMS (2022).

Regional capacities for critical material production, 2021

	Copper ^a	Nickel ^a	Nickel sulfate ^b	Cobalt ^a	Cobalt sulfate ^{c,a}	Lithium ^d	Lithium chemicals ^{c,d}	Neodymium oxide ^e
World	22 500	2 790	228	137	119	95	150	39
China	34%	29%	56%	69%	70%	59%	59%	90%
Europe	11%	0%	11%	16%	16%	0%	0%	0%
North America	7%	4%	0%	4%	4%	1%	1%	0%
Other Asia Pacific	16%	41%	17%	5%	5%	3%	3%	0%
Central & South America	14%	0%	0%	0%	0%	37%	37%	0%
Africa	8%	0%	0%	4%	4%	0%	0%	0%
Eurasia	7%	4%	0%	1%	1%	0%	0%	0%
Middle East	2%	0%	0%	0%	0%	0%	0%	0%
Unknown	0%	21%	16%	0%	0%	0%	0%	10%

Notes: Values are in kt. Lithium chemicals = Lithium carbonate + Lithium hydroxide

Sources: a. WBMS (2022), b. Fraser et al. (2021), c. BNEF (2022) d. S&P Global (2022c) e. Adamas Intelligence (2020).

Regional capacities for bulk material production, 2021

	Steel (Mt)	Cement (Mt)	Plastics (Mt)	Aluminium (Mt)
World	2 000	4 300	310	810
China	52%	55%	25%	9%
Europe	11%	7%	9%	2%
North America	6%	4%	18%	2%
Other Asia Pacific	19%	19%	24%	85%
Central & South America	2%	3%	2%	1%
Africa	1%	5%	1%	0%
Eurasia	4%	2%	3%	1%
Middle East	2%	4%	17%	1%

Source: IEA (2022a).

Technology and component manufacturing

Low-emission hydrogen supply chain

Manufacturing capacity for electrolysers, 2022

Electrolysers (GW _{el})	
World	11
China	41%
Europe	26%
North America	19%
Other Asia Pacific	14%
Central & South America	0%
Africa	0%
Eurasia	0%
Middle East	0%

Notes: Electrolyser manufacturing capacity includes all electrolysers independent of how these are used.

Source: IEA (2022a).

Low-emission electricity supply chain

Manufacturing capacity for wind technology components, 2021

	Tower (GW)		Nacelle (GW)		Blade (GW)	
	Onshore	Offshore	Onshore	Offshore	Onshore	Offshore
World	88	18	100	26	98	25
China	55%	53%	62%	73%	61%	83%
Europe	16%	41%	13%	26%	18%	12%
North America	11%	0%	10%	0%	10%	0%
Other Asia Pacific	12%	6%	8%	2%	6%	4%
Central & South America	5%	0%	6%	0%	4%	0%
Africa	1%	0%	0%	0%	0%	0%
Eurasia	0%	0%	0%	0%	0%	0%
Middle East	0%	0%	0%	0%	0%	0%

Notes: On towers: capacity for 2021 only includes facilities directly related to the wind industry; On all components' capacities: in 2022 certain facilities closed down, these are not accounted for as an uncertain amount can be reopened again, which is not clear as of this date.

Source: Data provided by Wood Mackenzie.

Manufacturing capacity and production for solar PV components, 2021

	Wafers		Cells		Modules	
	Production	Capacity	Production	Capacity	Production	Capacity
World	190	370	190	410	190	460
China	96%	96%	78%	85%	73%	75%
Europe	0%	1%	1%	1%	2%	3%
North America	0%	0%	1%	1%	5%	2%
Other Asia Pacific	3%	3%	18%	13%	19%	18%
Central & South America	0%	0%	0%	0%	0%	0%
Africa	0%	0%	0%	0%	0%	1%
Eurasia	0%	0%	0%	0%	1%	1%
Middle East	0%	0%	0%	0%	0%	0%

Source: InfoLink (2022).

Clean technology supply chains

Manufacturing capacity and production for electric cars and battery components, 2021

	Cathode (kt)		Anode (kt)		Batteries (GWh)		Electric cars (Millions)
	Production _{a,b}	Capacity ^a	Production _{a,b}	Capacity ^a	Production _{b,c}	Capacity ^c	
World	440	1400	250	810	340	910	6.8
China	77%	68%	92%	87%	66%	75%	54%
Europe	1%	1%	0%	0%	21%	8%	27%
North America	16%	1%	2%	1%	11%	6%	10%
Other Asia Pacific	5%	26%	7%	13%	2%	10%	7%
Central & South America	0%	0%	0%	0%	0%	0%	0%
Africa	0%	0%	0%	0%	0%	0%	0%
Eurasia	0%	0%	0%	0%	0%	0%	0%
Middle East	0%	0%	0%	0%	0%	0%	0%
Unknown	0%	2%	0%	1%	2%	0%	2%

Sources: IEA internal analysis and a. BNEF (2022), b. IEA (2022b), c. Benchmark Mineral Intelligence (2022), d. EV Volumes (2022).

Manufacturing capacity and production for heat pumps, 2021

	Heat pumps (GW)	
	Production ^{a,c}	Capacity ^{b,c}
World	100	120
China	38%	39%
Europe	16%	16%
North America	29%	29%
Other Asia Pacific	13%	14%
Central & South America	0%	0%
Africa	0%	0%
Eurasia	0%	0%
Middle East	2%	2%

Sources: a. IEA internal analysis and industry consultations, b. UN (2022), c. IEA (2022c).

Manufacturing capacity and production for fuel cell heavy-duty trucks components, 2021

	Fuel cell systems (GW)		Fuel cell trucks (thousand)	
	Capacity ^a	Production ^b	Capacity ^b	Production ^b
World	19	0.9	14	0.9
China	48%	84%	45%	84%
Europe	1%	9%	21%	9%
North America	4%	0%	18%	0%
Other Asia Pacific	38%	6%	14%	6%
Central & South America	0%	0%	0%	0%
Africa	0%	0%	0%	0%
Eurasia	0%	0%	0%	0%
Middle East	0%	0%	0%	0%
Unknown	7%	0%	0%	0%

Notes: It is assumed that production is proportional to sales.

Sources: a. E4tech (2022), b. IEA internal analysis and industry consultations.

Deployment

Low-emission hydrogen supply chain

Hydrogen production installed capacity, 2022

	Natural gas-based hydrogen with CCS	Electrolysers	
	Mt H ₂	Mt H ₂	GW _{el}
World	0.32	0.088	0.51
China	0%	3%	36%
Europe	3%	16%	31%
North America	96%	5%	9%
Other Asia Pacific	0%	42%	12%
Central & South America	0%	21%	5%
Africa	0%	1%	1%
Eurasia	0%	3%	5%
Middle East	0%	4%	1%

Notes: The installed capacity for electrolysers refers to electrolysers for dedicated hydrogen production in 2022, excluding their use in the chlor-alkali industry.

Source: IEA (2022d).

Low-emission electricity supply chain

Generation capacity additions of solar PV modules and wind energy, 2021

	Solar PV (GW)	Wind energy (GW)	
		Onshore	Offshore
World	150	150	21
China	37%	41%	80%
Europe	18%	18%	16%
North America	18%	20%	0%
Other Asia Pacific	20%	8%	5%
Central & South America	6%	6%	0%
Africa	1%	1%	0%
Eurasia	1%	2%	0%
Middle East	1%	0%	0%

Source: IEA (2022a).

Low-emission synthetic hydrocarbon fuels supply chain

Synthetic hydrocarbon fuel synthesis installed capacity with dedicated BECC or DAC, 2021

	BECC (Mt CO ₂)	DAC (Mt CO ₂)	Synthetic HC Fuels (bbl/d)
World	2	0.01	11
China	0%	0%	0%
Europe	17%	76%	100%
North America	75%	24%	0%
Asia-Pacific	8%	0%	0%
Central & South America	0%	0%	0%
Africa	0%	0%	0%
Eurasia	0%	0%	0%
Middle East	0%	0%	0%

Notes: Synthetic HC fuels = low-emission synthetic hydrocarbon fuels.

Source: IEA internal analysis and industry consultations.

Clean technology supply chains

Sales of electric cars, fuel cell trucks and heat pumps, 2021

	Electric cars Million	Fuel cell trucks Thousands	Heat pumps GW
World	6.6	1.7	96
China	53%	94%	33%
Europe	33%	5%	21%
North America	10%	0%	31%
Other Asia Pacific	3%	0%	12%
Central & South America	0%	0%	0%
Africa	0%	0%	0%
Eurasia	0%	0%	0%
Middle East	0%	0%	3%

Notes: Electric cars only include passenger light duty vehicles; Fuel cell trucks include heavy and medium freight trucks.

Sources: IEA (2022a), IEA (2022b).

Infrastructure

Electricity grid deployment, 2021

	Electricity grid additions (1000 km)	
	Transmission	Distribution
World	1300	140
China	24%	25%
Europe	16%	18%
North America	17%	18%
Other Asia Pacific	29%	16%
Central & South America	5%	7%
Africa	4%	5%
Eurasia	2%	4%
Middle East	4%	4%

Sources: IEA (2022a).

Other supply chain characteristics

Employment, 2019

Manufacturing employment			
Mass manufactured		Manufacturing	
<i>Established/Mature supply chains (total jobs) - thousand employees</i>			
Solar PV	Polysilicon	24	
	Wafers	88	
	Solar cells	200	
	Solar modules	270	
	Other solar jobs	330	
Wind energy	380		
Electric cars	660		
Heat pumps	120		
<i>Emerging/Nascent supply chains (job intensity) - thousand employees per unit</i>			
Electrolysers (GW/year)	0.5 - 1		
Fuel cell trucks (thousand trucks/year)	0.2 - 0.3		
Site-tailored (job intensity) - thousand employees per unit		Construction	Operation
Hydrocarbon synthetic fuels	BECC (Mt CO ₂ /year)	0.2 - 0.5	0 - 0.1
	DAC (Mt CO ₂ /year)	0.7 - 2	0.2 - 0.3
	Synthesis (PJ/year)	0.2 - 0.4	0 - 0.1

Notes: PV = photovoltaic; DAC = direct air capture; BECC = bioenergy with carbon capture.

Source: IEA (2022e).

Lead times

Lead time	year	
Manufacturing plants for mass-manufactured technologies		
Solar PV	Polysilicon	1 - 3.5
	Wafers	0.5 - 2
	Solar cells	0.5 - 2
	Solar modules	0.5 - 2
Wind	Blade	1 - 2
	Tower	1.5 - 2.5
	Nacelle	1.5 - 2
Electrolysers		2 - 3
Electric vehicles	Anode	2 - 5
	Cathode	2 - 5
	Battery	0.5 - 4.5
Heat pumps		1 - 3
Fuel cell trucks	Fuel cell stacks	1.5 - 2.5
	Fuel cell trucks	0.5 - 1.5
Large-scale, site-tailored technologies		
Gas-based H ₂ with CCS		1.5 - 9
Synthetic fuels	Hydrocarbon fuel synthesis	2.5 - 4
	DAC	2.5 - 5.5
	BECC	1 - 5
Infrastructure		
Electricity infrastructure	HVAC - OHL	5 - 13
	HVDC - cables	4 - 11
	Large power transformer	1 - 4
	Onshore pipeline	5 - 17.5
	Offshore pipeline	4 - 9
Natural gas infrastructure	Onshore LNG terminal	5 - 12
	Floating LNG terminal	1.5 - 10
	LNG tanker	1.5 - 4
	Underground gas storage	12
CO ₂ infrastructure	CO ₂ storage	4 - 10

Notes: PV = photovoltaic; DAC = direct air capture; BECC = bioenergy with carbon capture; HVAC = high-voltage alternating current; HVDC = high-voltage direct current; OHL = overhead line; LNG = liquified natural gas. Lead time refers to the time that passes from when a project is announced to when the project is commissioned. This includes feasibility studies, funding, permitting and actual construction of the facility or project. Experience on lead times for hydrogen infrastructure is limited, therefore lead times for natural gas infrastructure can provide a good indication for the lead times of hydrogen infrastructure due to similarities in project types and manufacturing/construction processes.

Sources: IEA internal analysis and industry consultations.

Regional definitions

Unless otherwise specified aggregated regions refer to the aggregation of countries as follows:

Africa: Algeria, Angola, Benin, Botswana, Burkina Faso, Burundi, Cabo Verde, Cameroon, Central African Republic, Chad, Comoros, Côte d'Ivoire, Democratic Republic of the Congo, Djibouti, Egypt, Equatorial Guinea, Eritrea, Eswatini, Ethiopia, Gabon, Gambia, Ghana, Guinea, Guinea-Bissau, Kenya, Lesotho, Liberia, Libya, Madagascar, Malawi, Mali, Mauritania, Mauritius, Morocco, Mozambique, Namibia, Niger, Nigeria, Republic of the Congo, Rwanda, Sao Tome and Principe, Senegal, Seychelles, Sierra Leone, Somalia, South Africa, South Sudan, Sudan, Togo, Tunisia, Uganda, United Republic of Tanzania, Zambia and Zimbabwe

Central and South America: Antigua and Barbuda, Argentina, Aruba, Bahamas, Barbados, Belize, Bermuda, Bolivia, Brazil, Cayman Islands, Chile, Colombia, Costa Rica, Cuba, Curaçao, Dominica, Dominican Republic, Ecuador, El Salvador, Grenada, Guatemala, Guyana, Haiti, Honduras, Jamaica, Nicaragua, Panama, Paraguay, Peru, Saint Kitts and Nevis, Saint Lucia, Saint Vincent and the Grenadines, Suriname, Trinidad and Tobago, Uruguay and Venezuela

China: People's Republic of China and, Hong Kong, China

Eurasia: Armenia, Azerbaijan, Georgia, Kazakhstan, Kyrgyz Republic, Russian Federation, Tajikistan, Turkmenistan and Uzbekistan

Europe: Albania, Austria, Belarus, Belgium, Bosnia and Herzegovina, Bulgaria, Croatia, Cyprus^{69,70}, Czechia, Denmark, Estonia, Finland, France, Germany, Gibraltar, Greece, Greenland, Hungary, Iceland, Ireland, Israel⁷¹, Italy, Kosovo, Latvia, Lithuania, Luxembourg, Malta, Monaco, Montenegro, Netherlands, North Macedonia, Norway, Poland, Portugal, Republic of Moldova, Romania, Serbia, Slovak Republic and Slovenia, Spain, Sweden, Switzerland, Türkiye, Ukraine and United Kingdom

Middle East: Bahrain, Iraq, Islamic Republic of Iran, Jordan, Kuwait, Lebanon, Oman, Qatar, Saudi Arabia, Syrian Arab Republic, United Arab Emirates and Yemen

North America: Canada, Mexico and United States

⁶⁹ Note by Republic of Türkiye: The information in this document with reference to "Cyprus" relates to the southern part of the island. There is no single authority representing both Turkish and Greek Cypriot people on the island. Türkiye recognises the Turkish Republic of Northern Cyprus (TRNC). Until a lasting and equitable solution is found within the context of the United Nations, Türkiye shall preserve its position concerning the "Cyprus issue".

⁷⁰ Note by all the European Union Member States of the OECD and the European Union: The Republic of Cyprus is recognised by all members of the United Nations with the exception of Türkiye. The information in this document relates to the area under the effective control of the Government of the Republic of Cyprus.

⁷¹ The statistical data for Israel are supplied by and under the responsibility of the relevant Israeli authorities. The use of such data by the OECD and/or the IEA is without prejudice to the status of the Golan Heights, East Jerusalem and Israeli settlements in the West Bank under the terms of international law.

Other Asia Pacific: Afghanistan, Australia, Bangladesh, Bhutan, Brunei Darussalam, Cambodia, Cook Islands, Dem. People's Rep. of Korea, Fiji, French Polynesia, India, Indonesia, Japan, Kiribati, Korea, Lao People's Democratic Republic, Malaysia, Maldives, Mongolia, Myanmar, Nepal, New Caledonia, New Zealand, Pakistan, Palau, Papua New Guinea, Philippines, Samoa, Singapore, Solomon Islands, Sri Lanka, Thailand, Timor-Leste, Tonga, Vanuatu and Viet Nam

Acronyms and abbreviations

ADNOC	Abu Dhabi National Oil Company
AEM	anion exchange membrane
APS	Announced Pledges Scenario
AUD	Australian dollars
BECC	bioenergy with carbon capture
CATL	Contemporary Amperex Technology Co. Limited
CCfD	carbon contracts for difference
CCS	carbon capture and storage
CCU	carbon capture and utilisation
CCUS	carbon capture, utilisation and storage
CEM IDDI	Clean Energy Ministerial's Industrial Deep Decarbonisation Initiative
CNOOC	China National Offshore Oil Corporation
CNPC	China National Petroleum Corporation
CO ₂	carbon dioxide
CO ₂ -eq	CO ₂ equivalent
DAC	direct air capture
DRI	direct reduced iron
EAF	electric arc furnace
ESG	environmental, social and governance
<i>ETP-2023</i>	Energy Technology Perspectives 2023
ETS	Emissions Trading System
EU	European Union
EV	electric vehicle
FCEV	fuel cell electric vehicle
FT	Fischer-Tropsch
GWP	global warming potential
ICE	internal combustion engine
ICMM	International Council on Mining and Metals
IEA	International Energy Agency
IPCC	Intergovernmental Panel on Climate Change
IPCEI	Important Projects of Common European Interest
IRA	Inflation Reduction Act
IT	information technology
Li-ion	lithium-ion
MHP	mixed hydroxide precipitate
MIIT	Ministry of Industry and Information Technology
ML	machine learning

NZE	Net Zero Emissions by 2050
PEM	proton-exchange membrane
PV	photovoltaic
RD&D	research, development and demonstration
REE	rare earth element
SCM	supplementary cementitious material
SMR	steam methane reforming
SOEC	solid oxide electrolyser cell
STEM	science, technology, engineering and mathematics
TSMC	Taiwan Semiconductor Manufacturing
WGS	water-gas shift

Units of measure

°C	degree Celsius
Bbl	barrel
bcm	billion cubic metres
EJ	exajoule
g CO ₂ /kWh	gramme CO ₂ per kilowatt hour
GJ	gigajoule
GJ/tonne	gigajoule per tonne
Gt	gigatonne
Gt CO ₂	gigatonne of carbon dioxide
GW	gigawatt
GW/year	gigawatt per year
GWh	gigawatt-hour
GW _{th}	gigawatt thermal
h	hour
kg	kilogramme
kg CO ₂ -eq/GJ	kilogramme of CO ₂ equivalent per gigajoule
kg CO ₂ /kg	kilogramme of CO ₂ per kilogramme
kg H ₂	kilogramme of hydrogen
km	kilometre
kt	kilotonne
kt/year	kilotonne per year
kt CO ₂ /year	kilotonne of carbon dioxide per year
kW	kilowatt
kW _e	kilowatt electric
kWh	kilowatt-hour
kWh/kg H ₂	kilowatt-hour per kilogramme of hydrogen
L	litre
L/100 km	km litre per 100 kilometres
MBtu	million British thermal unit
Mt	million tonnes

Mt/year	million tonnes per year
Mt CO ₂	million tonnes of carbon dioxide
Mt CO ₂ /year	million tonnes of carbon dioxide per year
Mt H ₂	million tonnes of hydrogen
MW	megawatt
MWh	megawatt-hour
PJ	petajoule
t	tonne
t CO ₂	tonne of carbon dioxide
t CO ₂ /year	tonne of carbon dioxide per year
TWh	terawatt-hour
USD	United States dollar
USD/GJ	United States dollar per gigajoule
USD/kg	United States dollar per kilogramme
USD/kg H ₂	United States dollar per kilogramme of hydrogen
USD/kW	United States dollar per kilowatt
USD/kW _e	United States dollar per kilowatt electric
USD/MBtu	United States dollar per million British thermal unit
USD/MWh	United States dollar per megawatt-hour
USD/t	United States dollar per tonne
USD/t CO ₂	United States dollar per tonne of carbon dioxide
USD/W	United States dollar per watt
Wh/kg	watt-hour per kilogramme

Currency conversions

Exchange rates (2021 annual average)	1 US dollar (USD) equals:
British Pound	0.73
Chinese Yuan Renminbi	6.45
Euro	0.84
Indian Rupee	73.92
Japanese Yen	109.75

Source: OECD (2022).

References

- Adamas Intelligence (2020), Rare earth magnet market outlook to 2030.
- Benchmark Mineral Intelligence (2022), Battery Gigafactories database.
- BNEF (BloombergNEF) (2022), 1H 2022 Battery Metals Outlook: Supply Turbulence Ahead.
- E4tech (2022), Database, <https://www.e4tech.com/>
- EV Volumes (2022), The electric vehicle world sales database, <https://www.ev-volumes.com/>
- Fraser, J., Anderson, J., Lazuen, J., Lu, Y., Heathman, O., Brewster, N., Bedder, J. and Masson, O. (2021), Study on future demand and supply security of nickel for electric vehicle batteries, Roskill, <https://publications.jrc.ec.europa.eu/repository/handle/JRC123439>
- IEA (International Energy Agency) (2022a), World Energy Outlook 2022, <https://www.iea.org/reports/world-energy-outlook-2022>
- IEA (2022b), Global Electric Vehicle Outlook 2022, <https://www.iea.org/reports/global-ev-outlook-2022>
- IEA (2022c), Heat Pumps, <https://www.iea.org/reports/heat-pumps>
- IEA (2022d), Hydrogen Projects Database, <https://www.iea.org/data-and-statistics/data-product/hydrogen-projects-database>
- IEA (2022e), World Energy Employment Report, <https://www.iea.org/reports/world-energy-employment>
- InfoLink (2022), InfoLink online database, <https://www.infolink-group.com/index/en>
- OECD (2022), OECD National Accounts Statistics, https://www.oecd-ilibrary.org/economics/data/oecd-national-accounts-statistics_na-data-en
- S&P Global (2022a), Copper global supply-demand balance, August 2022.
- S&P Global (2022b), Nickel global supply-demand balance, August 2022
- S&P Global (2022c), Lithium and cobalt global supply-demand balance, January 2022.
- UN (United Nations) (2022), Comtrade Database, <https://comtradeplus.un.org/>
- USGS (United States Geological Survey) (2022), Mineral Commodity Summaries 2022, <https://pubs.er.usgs.gov/publication/mcs2022>
- WBMS (World Bureau of Metal Statistics) (2022), World Metal Statistics Yearbook.

International Energy Agency (IEA).

This work reflects the views of the IEA Secretariat but does not necessarily reflect those of the IEA's individual Member countries or of any particular funder or collaborator. The work does not constitute professional advice on any specific issue or situation. The IEA makes no representation or warranty, express or implied, in respect of the work's contents (including its completeness or accuracy) and shall not be responsible for any use of, or reliance on, the work.



Subject to the IEA's [Notice for CC-licensed Content](#), this work is licenced under a [Creative Commons Attribution 4.0 International Licence](#).

This document and any map included herein are without prejudice to the status of or sovereignty over any territory, to the delimitation of international frontiers and boundaries and to the name of any territory, city or area.

Unless otherwise indicated, all material presented in figures and tables is derived from IEA data and analysis.

IEA Publications International Energy Agency Website: www.iea.org

Contact information: www.iea.org/contact

Typeset in France by IEA – January 2023

Cover design: IEA

Photo credits: © GettyImages

