

360° SERVICES

The structure of Ferco Seating has departments at all levels, allowing the project to be monitored from start to finish.

“We’re most proud of our people. They’re here to inspire you. To help you create a space that in turn inspires and entertains your audiences”.

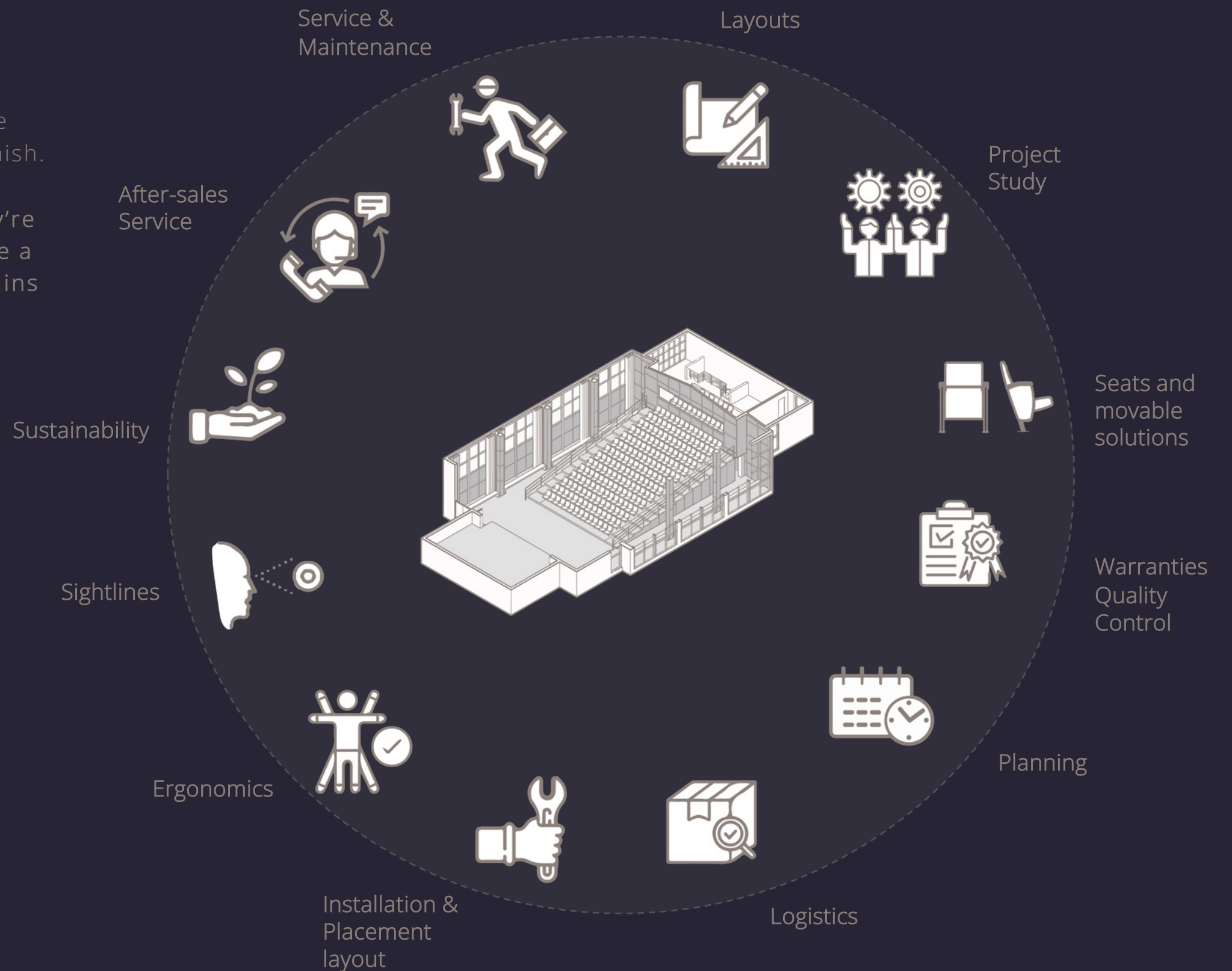

OUR MISSION

At Ferco Seating we focus on sustainable design-led solutions that inspire our customers. Led by these core values we continue our mission to be the world's preferred seating company.



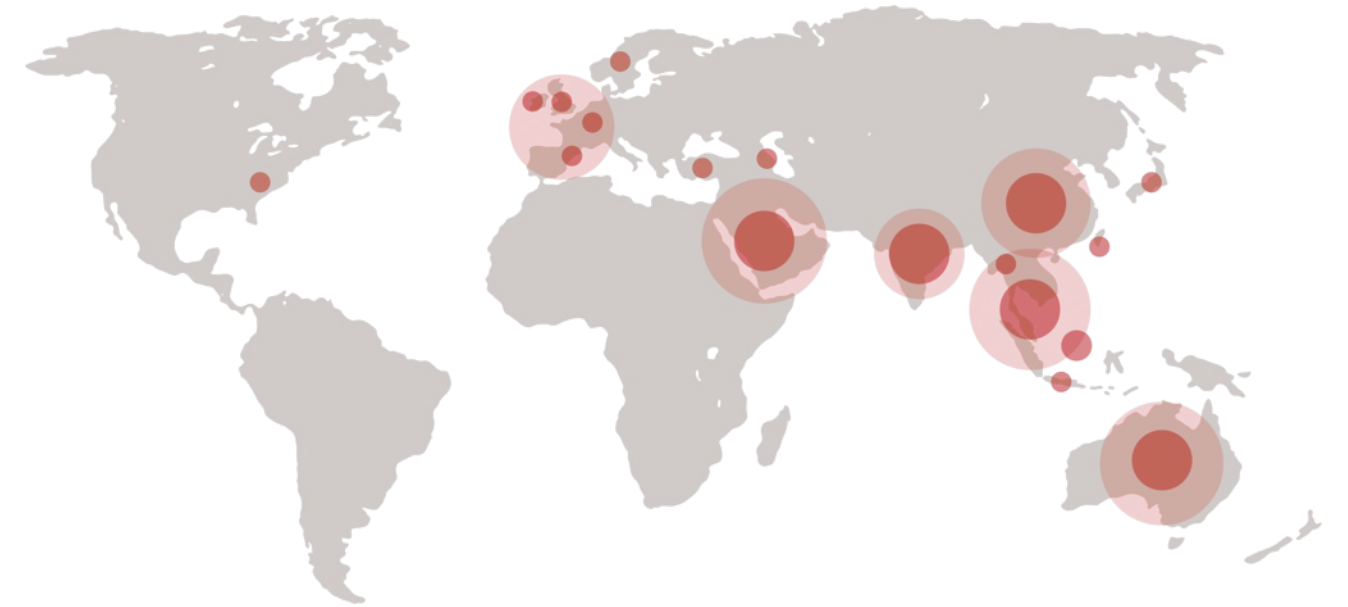

INTERNATIONAL PROJECTS

For more than 40 years, Ferco Seating has been installing its seating in renowned international projects, working closely with the best architects in the world: Zaha Hadid, Franck Gehry, Cesar Pelli, Moshe Safdie...



OUR VISION

We're passionate about the environment – and about providing world-class workplaces. All our products are made in safe working environments that are eco-friendly as possible. And we're constantly looking for new ways to improve our quality, environmental and safety management systems.

Our production management processes and environmental management systems have been strictly regulated to achieve both maximum efficiency and minimum environmental impact.

We have stringent quality checks in place, from order to shipping. We're making sure our carbon footprint is as small as possible.



OUR PRODUCTS

Our state-of-the-art facility incorporates the latest technology and manufacturing methods with rigorous quality control. Our goal is to exceed our customer's expectations.

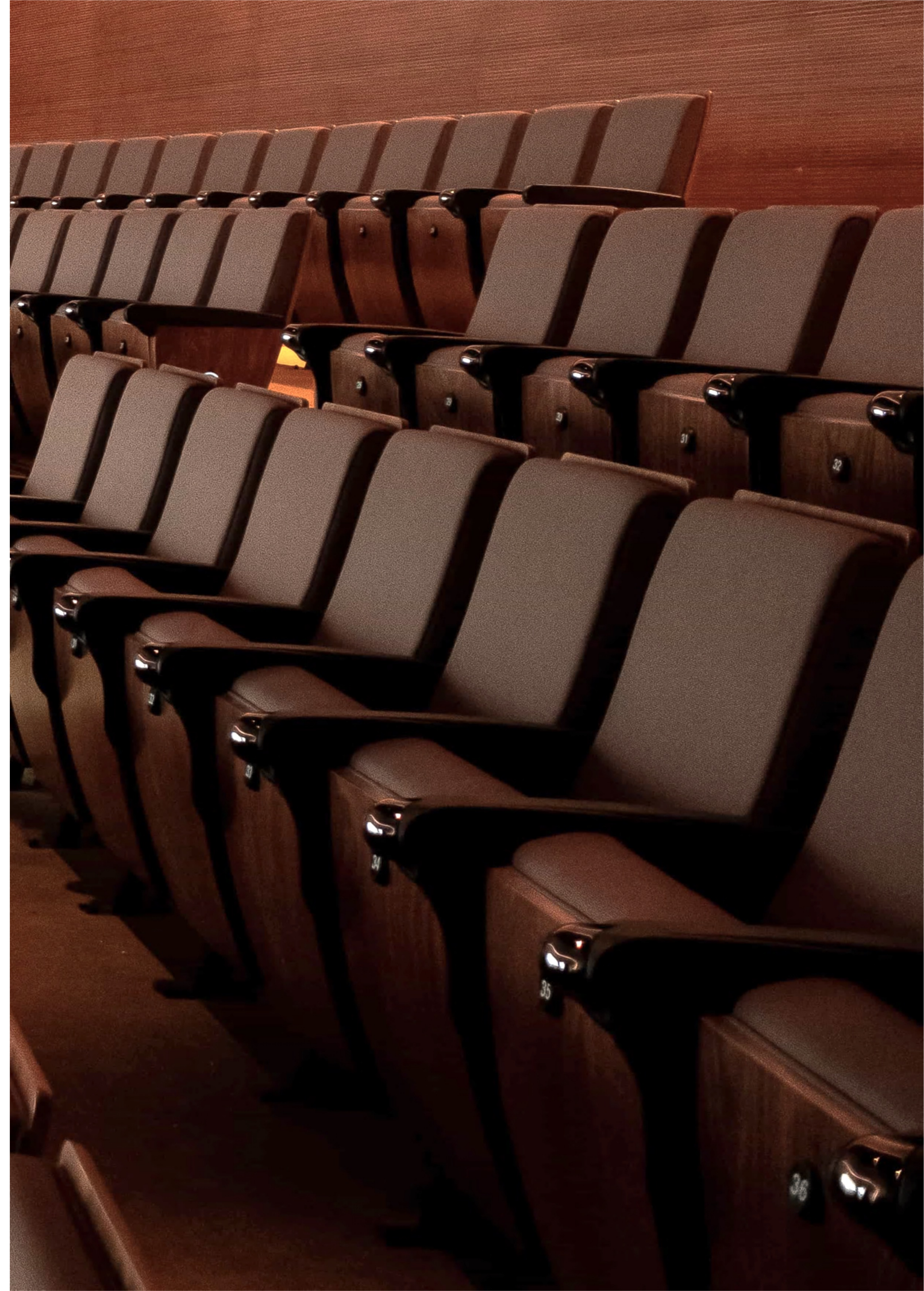

BEAUFORT

GENERAL DESCRIPTION

The stylish Beaufort designed by Ferco is a highly customisable option for traditional theatre and performance spaces, as well as high-end corporate auditoriums and educational spaces. The option of a small closed depth, variable seat centres and pitches means that the seat can be installed into small spaces and tiers of 800mm depth without compromising on comfort or access.

The standard Beaufort is fully upholstered in a fabric of your choice, with a range of laminated wooden armrests. Wooden finishing, acoustic dampeners, cup holders and writing tablets can all be integrated to create a truly unique aesthetic.

PRODUCT DETAILS

Backrest

Fixed rectangular shape with curvature design for the back.

Fully upholstery backrest.

Inner panel shall be made of 13mm thick plywood covered with high resilience foam, density 45 kg/m³.

Seat

Rectangular shape with concave design for better sitting comfort.

Inner structure made of Ø21 tubular steel frame with metal strap attachment, integrated in high resilience foam, density 60kg/m³.

Fully upholstered and removable by means of zipper.

Armrest

Armrest top constructed with 30 mm wood thickness. Decorative aisle panel made of MDF board upholstered with padded cover.

Metal Finishing

All metal parts exposed shall be stripped and cleaned with iron phosphate, hot water rinsed, and then chromic acid rinsed. All metal parts are coated with an epoxy finish of at least 60 microns for indoor use. Conformity with BS-6496 hardness test.

Standards

Centre and end standards are of lateral pedestal design made of 38 x 2.3mm Thk. square hollow section continuous welded to 6mm thickness steel plate.

Fire Safety

Fire Safety - Flammability compliance with California Bulletin 117 and international regulations in their last issues and particularly with safety regulations. Flammability compliance with BS 5852 : 2006 Section 3 Ignition Source 0 & 1.

Options

- Row lettering type A
- Row lettering type E with Aisle light
- Round row letter
- Embroidery logo
- Embroidery seat numbering
- Diffuser leg
- Tandem removable leg
- Free standing leg
- Castor wheel
- A.D.A Panel
- Wrimatic lite
- Wooden outer back / seat outer
- Wooden / upholstered armrest
- Wooden panel
- Probax
- Flammability compliance with BS 5852 : 2006 Section 3 Ignition Source 5



Liverpool Catholic Club - UK

(1) 640 / (2) 710

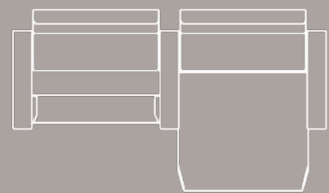

(1) 415 / (2) 480



(1) 910
(2) 885

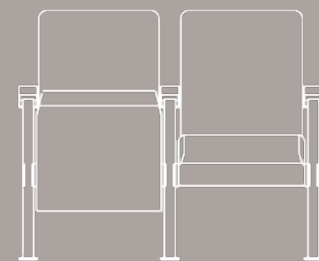

485/ 510/ 535/ 560

P(°) = (1) 17° / (2) 23°



ABERYSTWYTH ARTS CENTRE

BEAUFORT SEAT

Located on Aberystwyth University's Penglais Campus with views along the coastline of Cardigan Bay, the Aberystwyth Arts Centre is Wales' largest arts centre and is recognised as a national flagship. The award-winning enterprise has a wide-ranging artistic programme and houses a theatre, concert hall, studio and cinema, as well as gallery space, cafes, bars and shops.

Originally opening as a concert hall in 1970, the building expanded in 1972 to house the theatre - Theatr y Werin - which translates as 'theatre of the people'.

The theatre has 311 seats and showcases both professional and community productions. The programme includes a range of theatre, dance, opera, comedy, musicals and family events, with a family show at Christmas, and a traditional pantomime.

The team in charge of the most recent renovation at the theatre chose Ferco's market-leading Primera Beaufort.

Designed to complement modern theatres and auditorium, the Beaufort has clean lines and a contemporary aesthetic.

Theatr y Werin took advantage of its customisable features and chose a wooden back with reveal, matching wooden aisle ends and wooden armrests teamed with a plush red velour fabric.



2023 / Seats: 331

UK

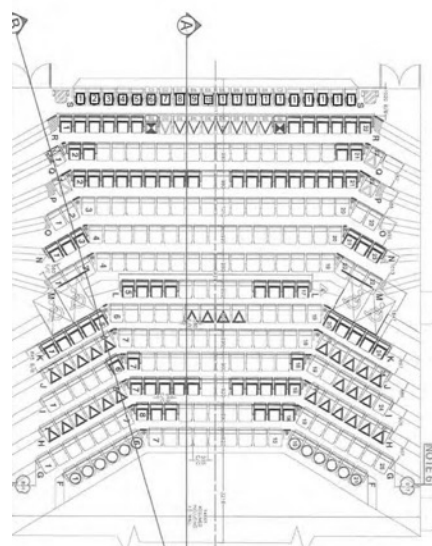

THEATRE SEVERN

BEAUFORT SEAT

Theatre Severn was officially opened on 25 March 2009 and is situated on Frankwell Quay, a beautiful and tranquil riverside location based in Shrewsbury Town Centre.

With the success of the Music Hall over the last decade it became apparent that there was demand for a new theatre venue.

Construction began in November 2006. The architects for the project were Austin Smith Lord and the theatre was built by Wilmott Dixon.

The Primera Pacific seat was chosen for this landmark venue with 650 capacity. The Pacific is a supremely comfortable auditorium chair designed to be maintenance free and enabling maximum egress due to its compact envelope.

The seat model Primera Pacific have the following characteristics:

- Compact envelope
- Removable seat covers
- Options for wooden armrests
- Sprung seat for maximum comfort 650 capacity

2006 / Seats: 650

UK

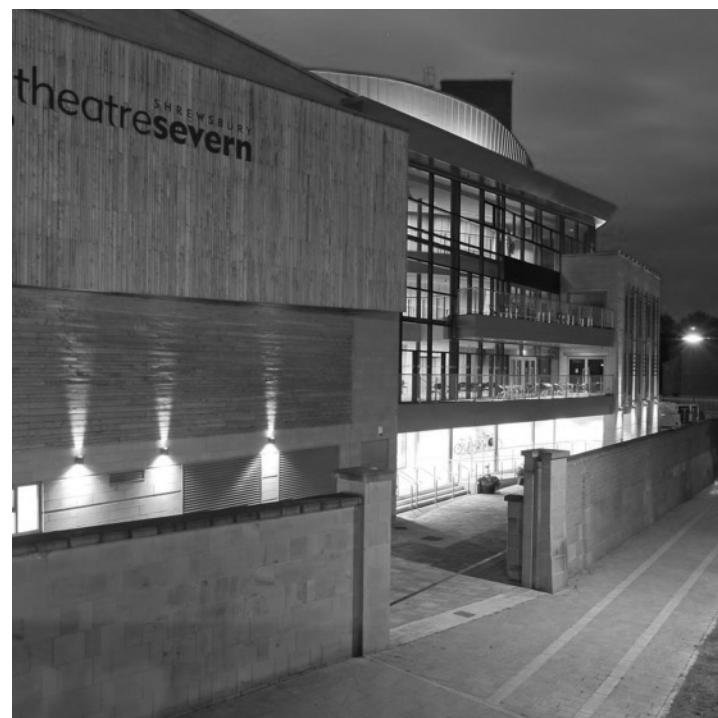
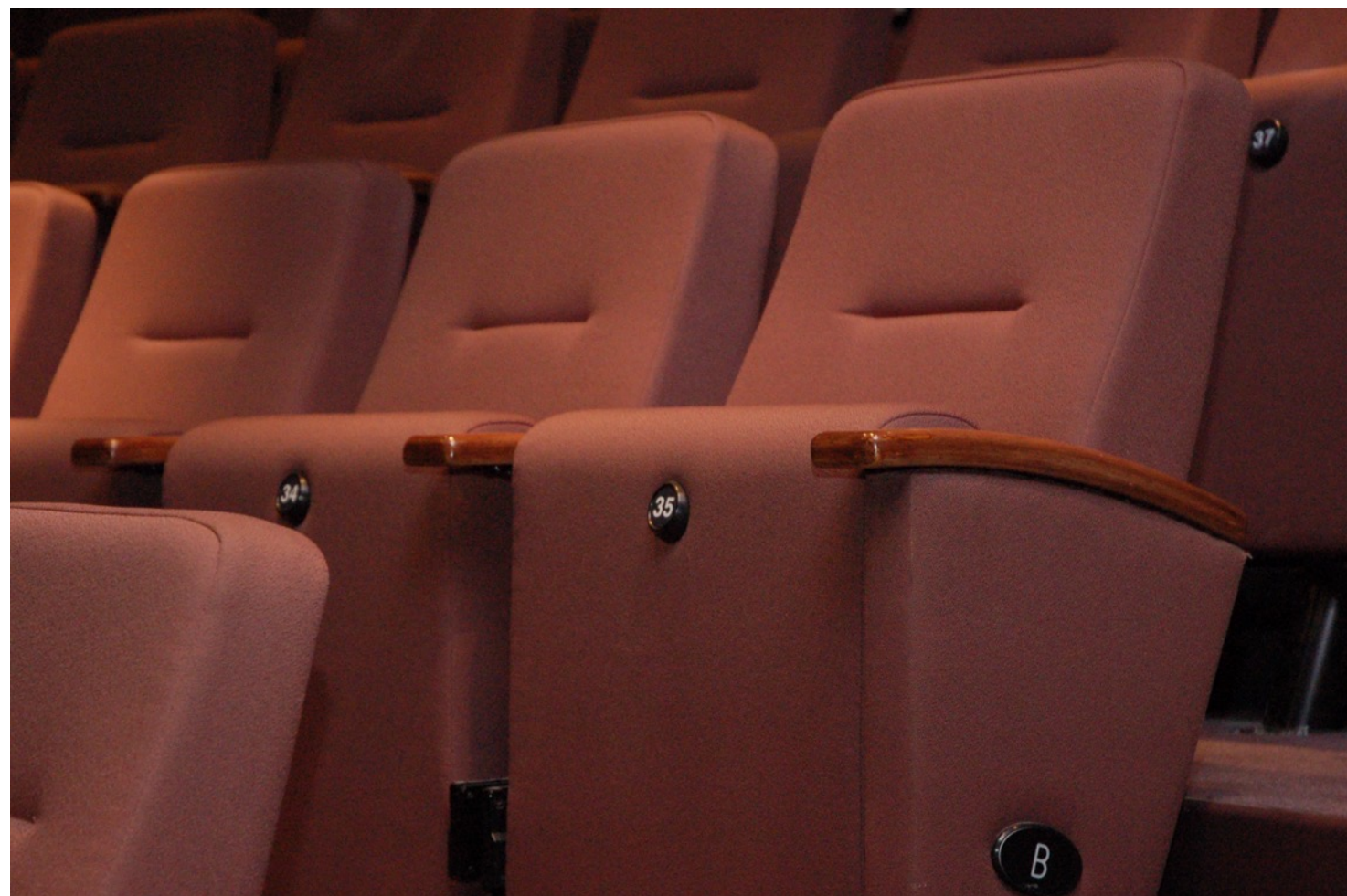

THE MILLER CENTRE

BEAUFORT SEAT

2018 / Seats: 186

UK

The Miller Centre was opened in October 1977. Its aim is to provide a friendly atmosphere and a workplace where people who miss the companionship of others can find a sense of purpose by helping to run a community theatre.

Originally a church and then a school, the premises were converted to a day centre and theatre by The Miller Centre Trust. Following a substantial refurbishment in 2018 to provide more comfort and legroom for patrons, the theatre has 186 seats (96 raked) and can be adapted for both proscenium arch and in the round productions. It is also used as a cinema once a month to show modern blockbusters and classic films.

The centre was named after Dorothy Miller, founder of the Caterham Players in 1945.

The Primera Beaufort seat was chosen for this popular venue. The Beaufort offers a stylish aesthetic and a comfortable seating position for guests.

The seat has removable seat covers and hardwearing black PU armrests and has been upholstered in a luxurious velour fabric.

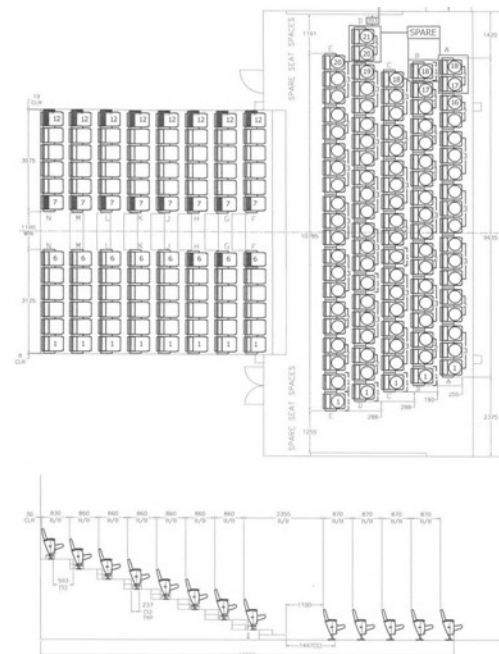

WOKINGHAM THEATRE

BEAUFORT SEAT

2019 / Seats: 163

UK

Wokingham Theatre was formed in 1947 and is a vibrant community theatre group.

Community theatre has been a popular tradition for centuries, providing a much appreciated form of entertainment enjoyed by all levels of society, it is typically defined as a type of theatre intended for and often managed by members of the local community. Providing eight full-length productions a year, as well as extra smaller productions, including youth theatre, the company moved into their current location in 1986.

The theatre is staffed entirely by local volunteers and is managed by a volunteer Board of Directors elected from the membership by democratic vote each year.

The experience of the community theatre is not merely measured in terms of the actual performance - it is also about the venue. Wokingham Theatre wished to upgrade the theatre seating, improving their guests overall experience.

The board chose the popular Beaufort from Ferco's Primera auditorium seating range.

The Beaufort has a stylish and contemporary aesthetic, perfect for the upgraded auditorium. The standard finish offers a fully upholstered seat with practical and durable wooden armrests. Wokingham's seats are upholstered in Camira's Main Line Plus fabric in a vibrant red colour.

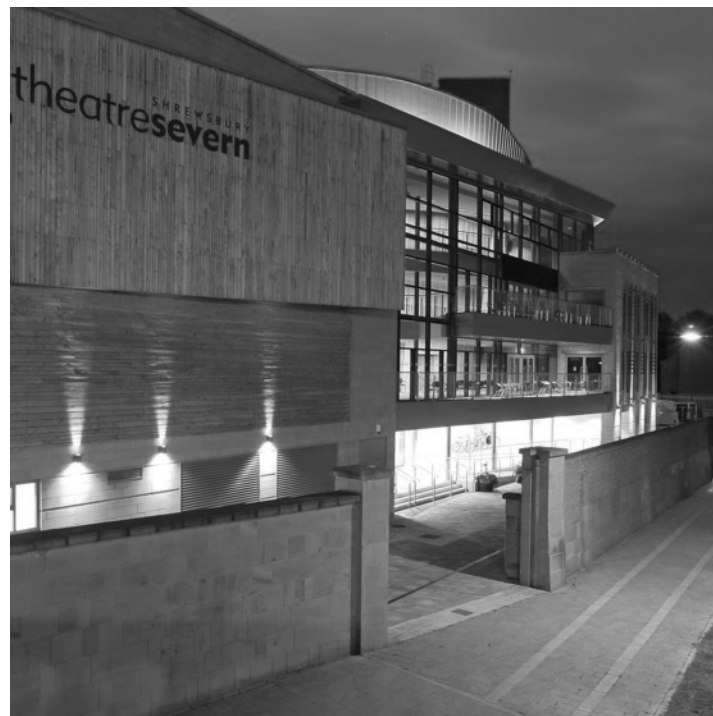
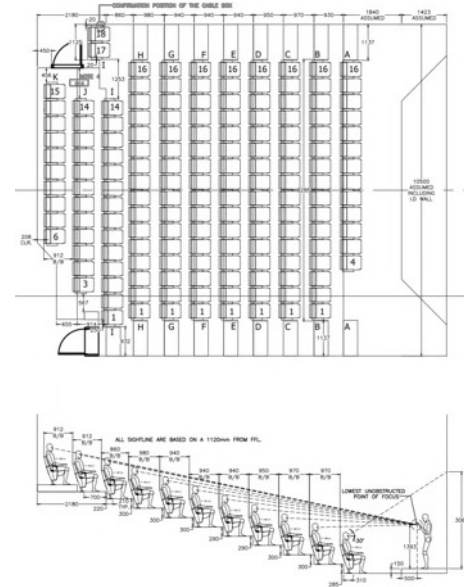

ADC THEATRE

BEAUFORT SEAT

201 / Seats: 228

UK

The ADC Theatre is a theatre in Cambridge, the oldest University playhouse in the country and also a department of the University of Cambridge. The theatre is owned by the Cambridge University Amateur Dramatic Club (CUADC), but is currently run as the smallest department of the university, with four full-time and two part-time staff. It is a producing theatre with the CUADC as its resident company.

In the summer of 2018, the theatre closed for renovations. Air conditioning and new seating were installed to the auditorium, a small extension was made to office space, and additional points for rigging lights were installed.

The Beaufort seat meets the parameters of both space and egress regulations for the theatre and fitted perfectly into the existing theatre design with no change to the 228 capacity.

The Beaufort Theatre seat with its clean lines is an ideal choice for a stylish, contemporary aesthetic and is highly customisable. The Beaufort has wooden armrests providing a pleasing aesthetic whilst also negating the issue of fabric 'wear' to these high impact areas.

To offset the wooden detailing, the seats were upholstered in a luxurious deep purple plush velvet fabric.

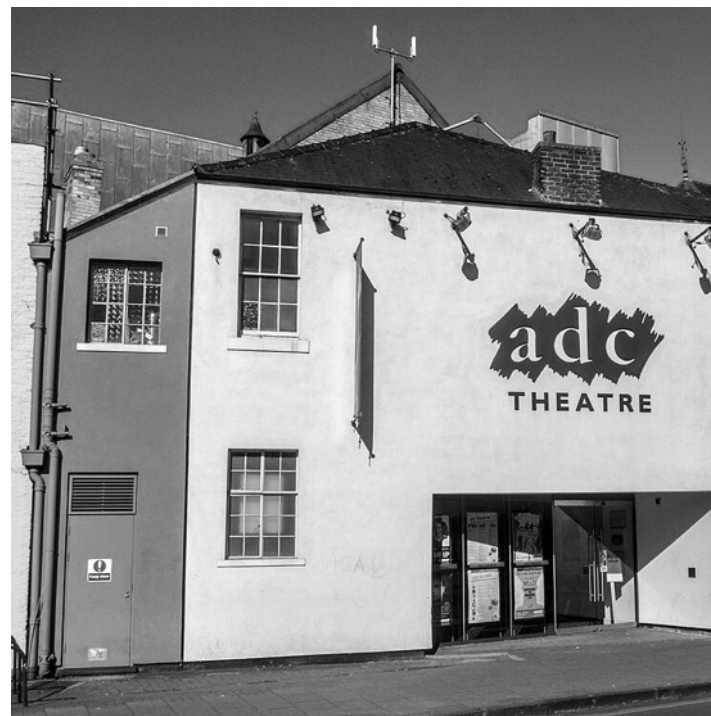
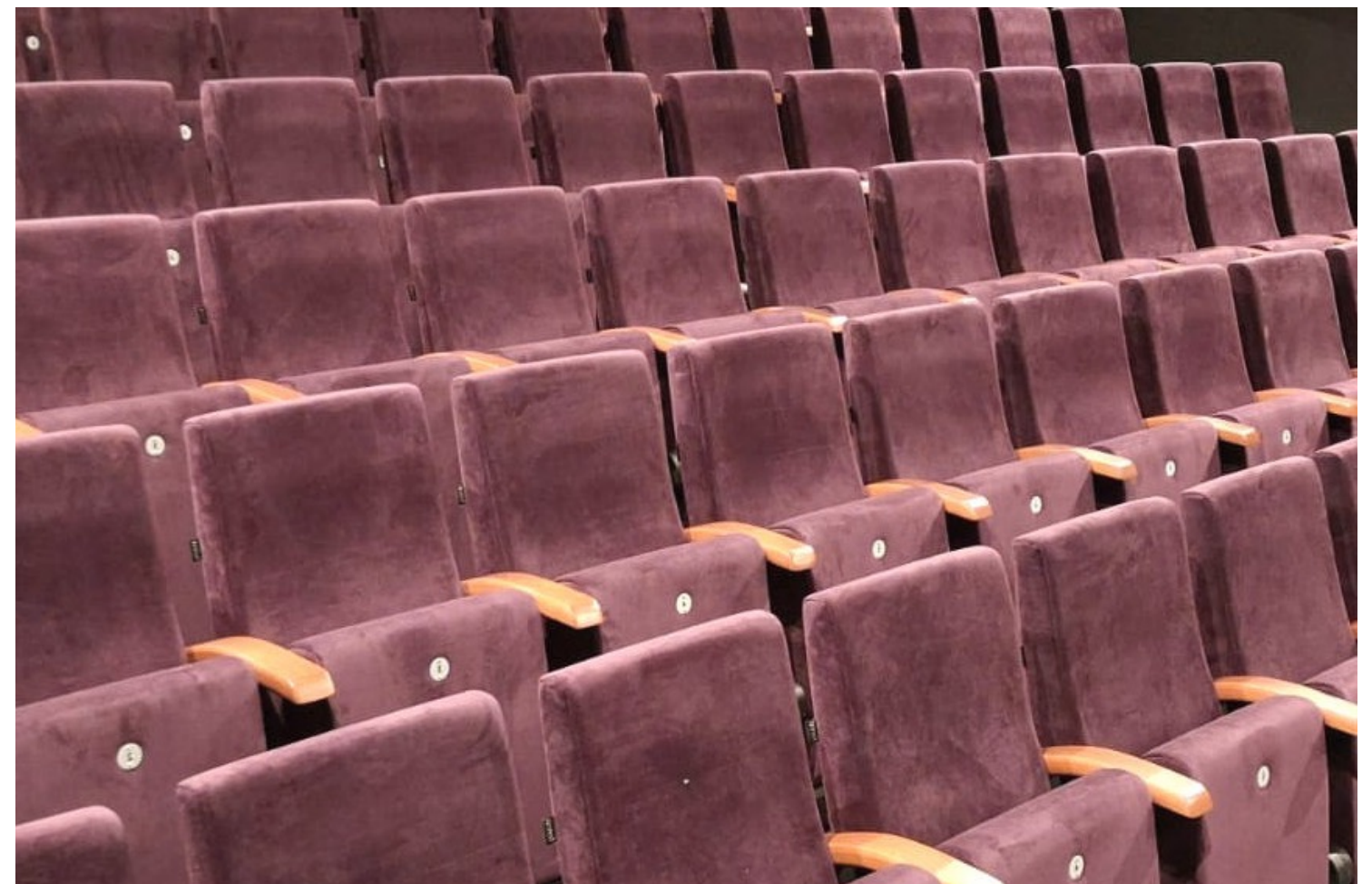
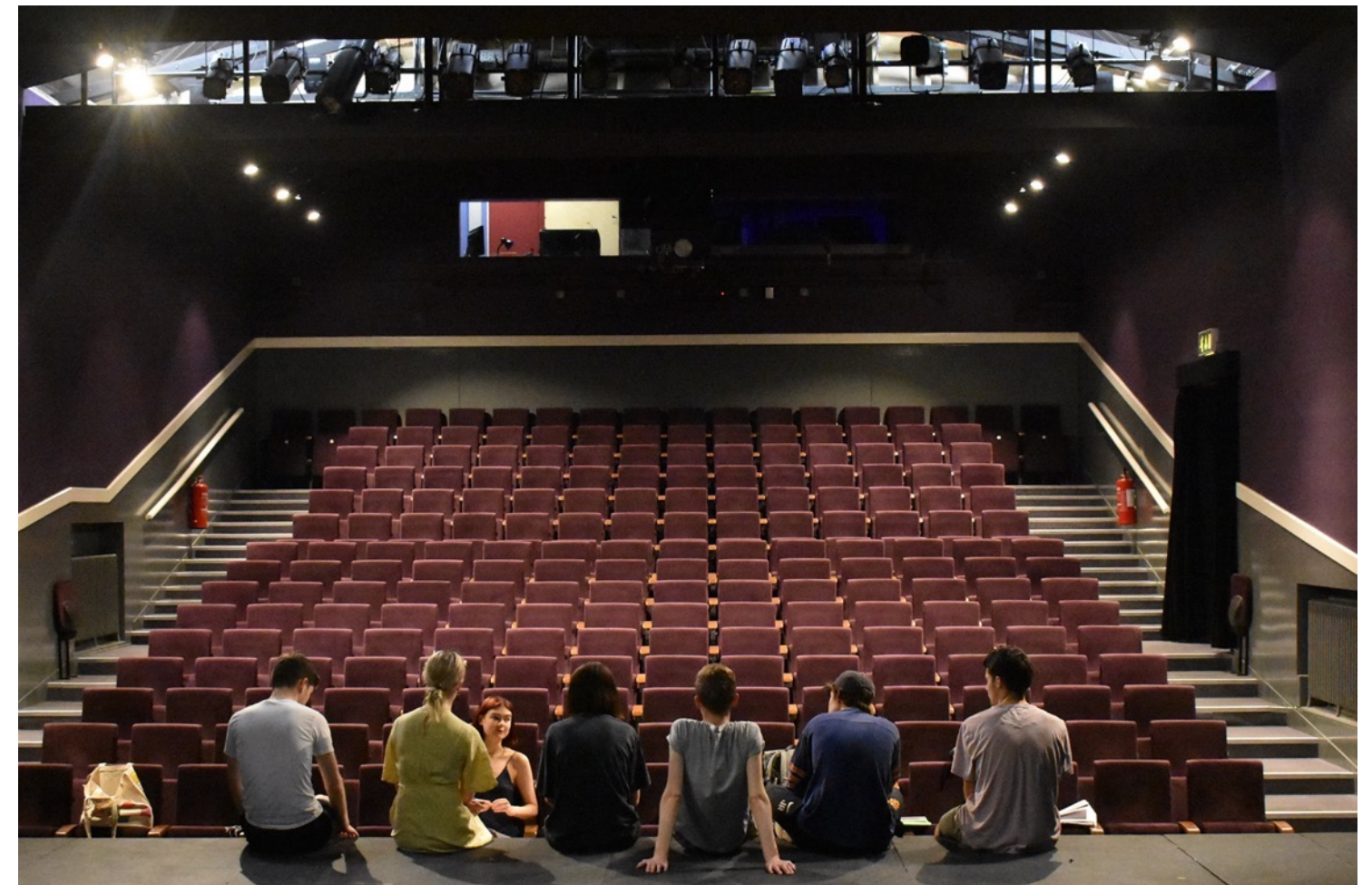
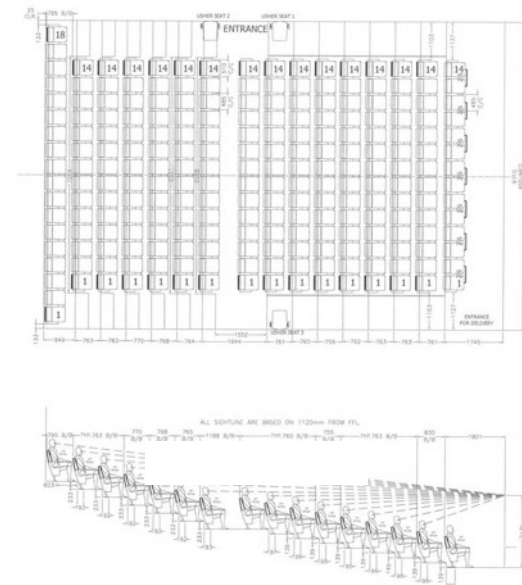

ATLANTIC

GENERAL DESCRIPTION

The Atlantic is a chair providing levels of comfort and versatility beyond its compact size. Ideal for both refurbishments and new projects, the variety of seat centre choices enables clients to maximise seating capacity without compromising on form or function.

Cold cure moulded foam ensures long lasting comfort while the polyurethane armrests will outlast all those in fabric.

The moulded foam cushions wrap the support springs in an airtight cocoon preventing both noise and corrosion. Its compact envelope allows for ease of access and egress. The Atlantic seat is popular with various types of places of worship, providing a much-improved visitor experience with enhanced comfort and aesthetics.

PRODUCT DETAILS

Backrest

Fixed, trapezoidal shape with curvature design.
Fully upholstered rear outer panel.

Inner panel shall be made of 13 mm thick plywood.
Covered with HR foam, density 45 kg/m³ and upholstered in padded cover.

Seat

Rectangular shape with curved design.
Inner structure made of Ø21mm x Thick. 2.6mm tubular steel frame, integrated with high resilience foam, density 60kg/m³.
Upholstered with padded cover, removable by means of a zipper.
Tip-up seat with counterweight systems and being lift-up by means of gravity. Totally silent and maintenance free.

Armrest

Fixed, shared armrest with a curved design.
Made of polyurethane.
Decorative aisle panel, made of MDF board and upholstered with padded covers.

Metal Finishing

All metal parts exposed shall be stripped and cleaned with iron phosphate, hot water rinsed and then chromic acid rinsed.

All metal parts are coated with an epoxy finish of at least 60 microns for indoor use.

Conformity with BS-6496 hardness test.

Standards

Centre and end standards are of lateral pedestal design made of 38mm x Thick 2.3mm square hollow section continuous welded to a 6 mm thickness steel plate.

Fire Safety

Fire Safety - Flammability compliance with California Bulletin 117 and international regulations in their last issues and particularly with safety regulations.
Flammability compliance with BS 5852 : 2006 Section 3 Ignition Source 0 & 1.

Options

Round seat numbering
Wooden armrest
Upholstered armrest
Wooden panel
Row lettering type E with Aisle light
Row lettering type A
Embroidery seat numbering
Embroidery logo
Tandem free standing / Tandem removable leg
Wooden outer back & seat outer
A.D.A Panel
Flammability compliance with BS 5852 : 2006 Section 3 Ignition Source 5



Theatre Royal Dumfries – Scotland

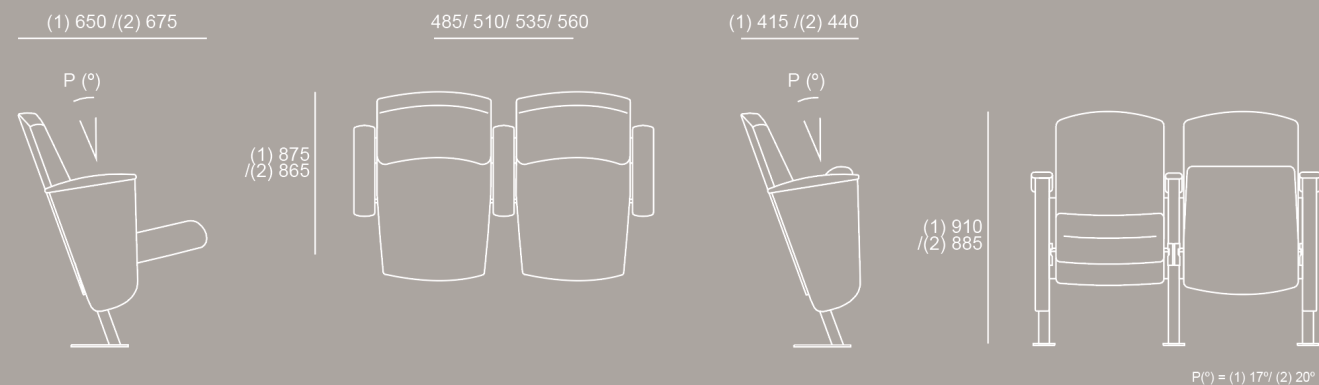

ROYAL DUMFRIES THEATRE

ATLANTIC SEAT

The Theatre Royal in Dumfries is the oldest working theatre in Scotland. The Theatre is owned by the Guild of Players who bought it in 1959, thereby saving it from demolition. The Guild's aim is to promote the tradition of live theatre in Dumfries. It is the venue for the Guild of Players' own productions and for performances from visiting companies. In addition it is used extensively as a venue for the Dumfries and Galloway Arts Festival, the Dumfries Music Festival and the Dumfries Musical Theatre Company.

The theatre has been further renovated and extended in the 21st century, with the help of a grant from The Holywood Trust, and reopened in December 2015.

The newly refurbished building includes several new spaces while maintaining many of the historic features, ushering Scotland's oldest theatre into the 21st Century.

Ferco were engaged by the Theatre to provide 190 seats for the main auditorium. The Primera Atlantic seat was chosen for its traditional aesthetic, providing levels of comfort and versatility beyond its compact size. The Atlantic comes in a variety of seat centres, meaning that maximum capacity can be achieved, without compromising on layout. The seat is durable and virtually maintenance free, with removable seat covers to extend the life of the installation.

2015 / Seats: 190

UK

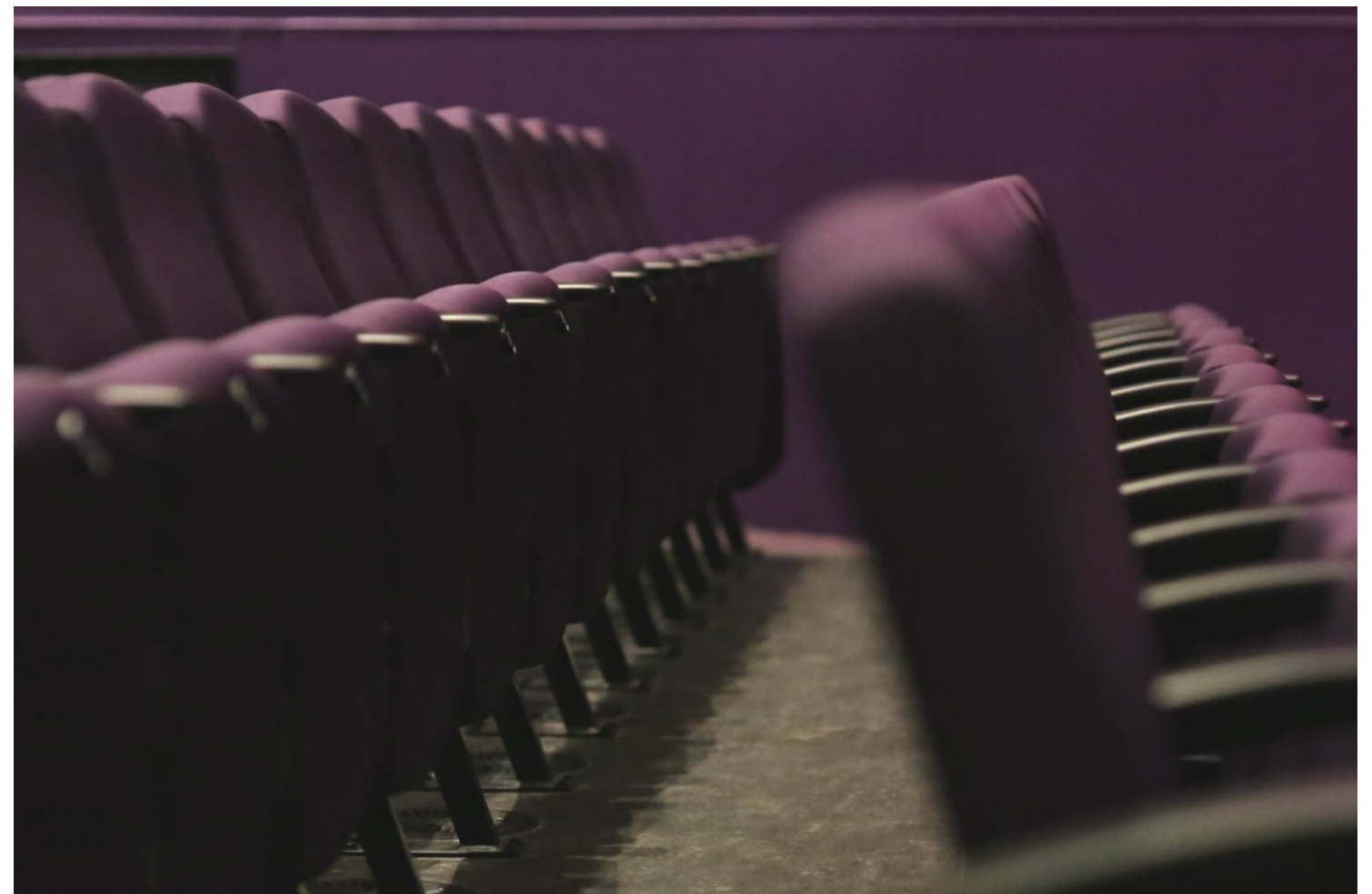
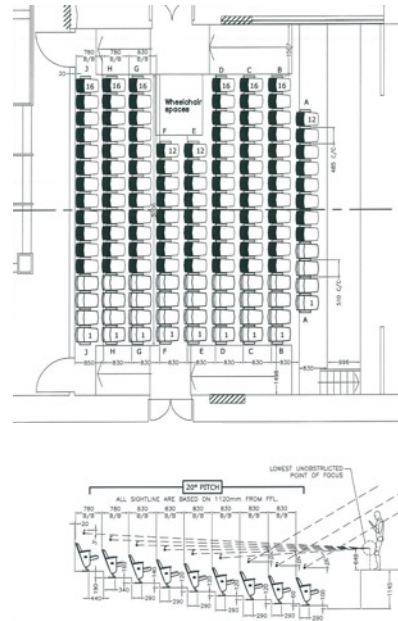

STAFFORD GATEHOUSE THEATRE

ATLANTIC SEAT

Set in a modern gothic style building the Stafford Gatehouse Theatre is situated in the middle of the city and provides arts and entertainment including Shakespeare and a successful pantomime. Ferco Seating were tasked with installing tiering / raking and a new theatre seat.

The Atlantic theatre chair was chosen for its comfort and versatility - it is an ideal seat for refurbishment projects as it has a variety of seat centre choices enabling the maximisation audience capacity.

Characteristics of the seat

- Robust sloping standards for lifetime support.
- Polyurethane armcaps for comfort and durability.
- Sprung seat for maximum comfort.
- Cold cure moulded foam is waterproof, comfortable and long lasting.
- Removable seat covers when cleaning or repair is necessary.
- Backrest fixed to standard with long wing brackets, reducing stresses and extending lifetime.
- Ergonomically designed.
- Installation and maintenance friendly.

2011 / Seats: 552

UK

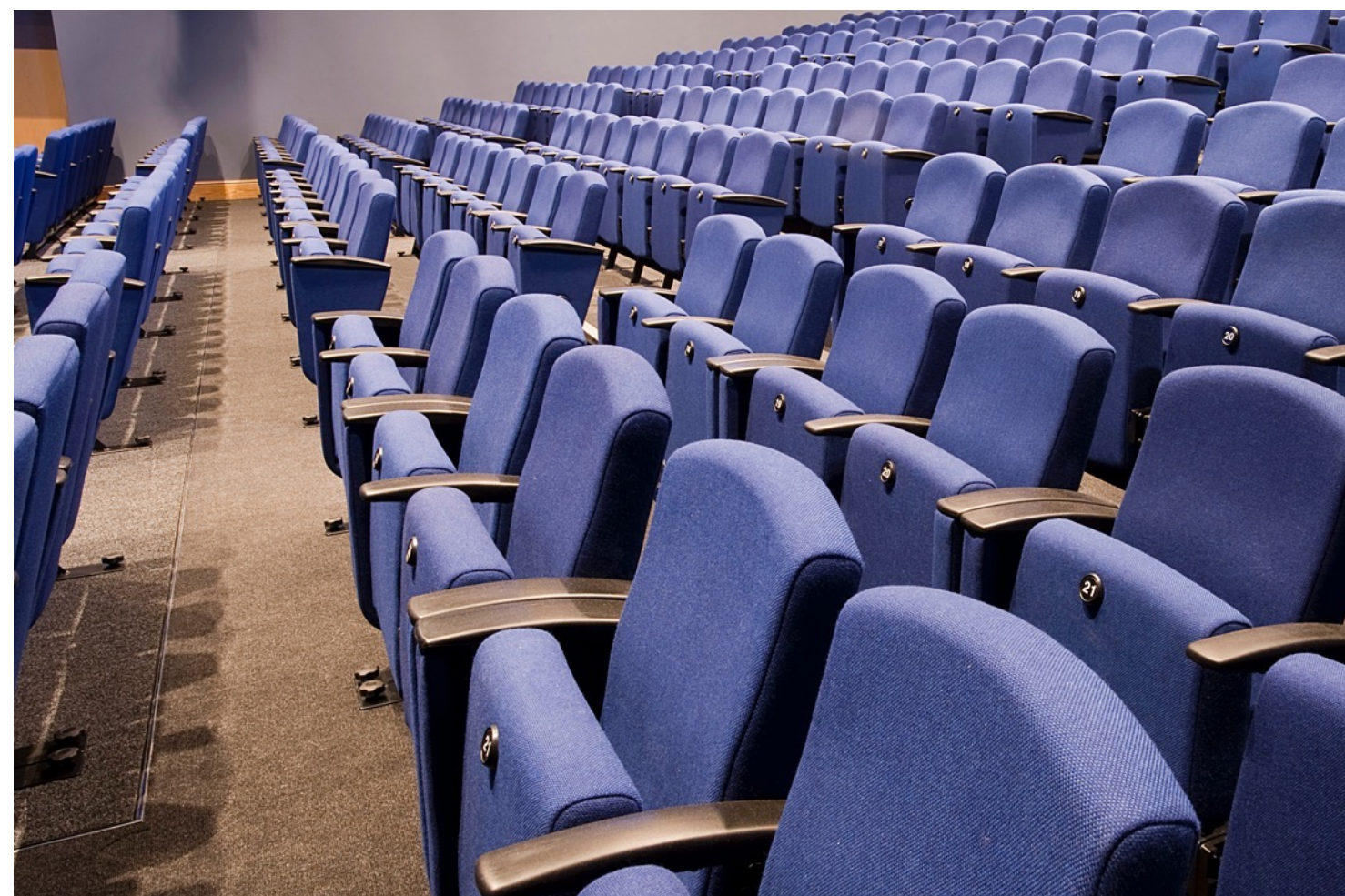
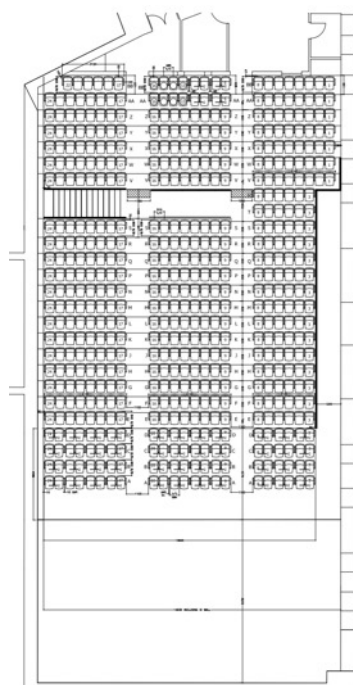

STAFFORD
GATEHOUSE
THEATRE

THE STAG THEATRE

ATLANTIC SEAT

2016 / Seats: 450

UK

The Stag Community Arts Centre now operates as a charity, and includes a theatre, two digital cinema screens, and an alternative performance and conferencing facility. The Stag was originally built as the Majestic Cinema, and opened on August 22 1936.

Various refurbishments and new innovations were introduced over the coming years and after several campaigns expressing their need for a theatre in Sevenoaks, the former cinema was transformed in 1983. The two lower-level cinemas were retained, and the large auditorium converted.

The 1990s cinema seats were replaced in 2016 - and with an overall investment of £110,000 improving cinema picture quality, sound quality and operational flexibility for people to enjoy attending their local family friendly cinema in Sevenoaks.

Ferco was asked to replace the seating in two of the theatre auditoriums with the the Atlantic being chosen for its comfort and choice of centres ensuring that seating capacity is maximised.

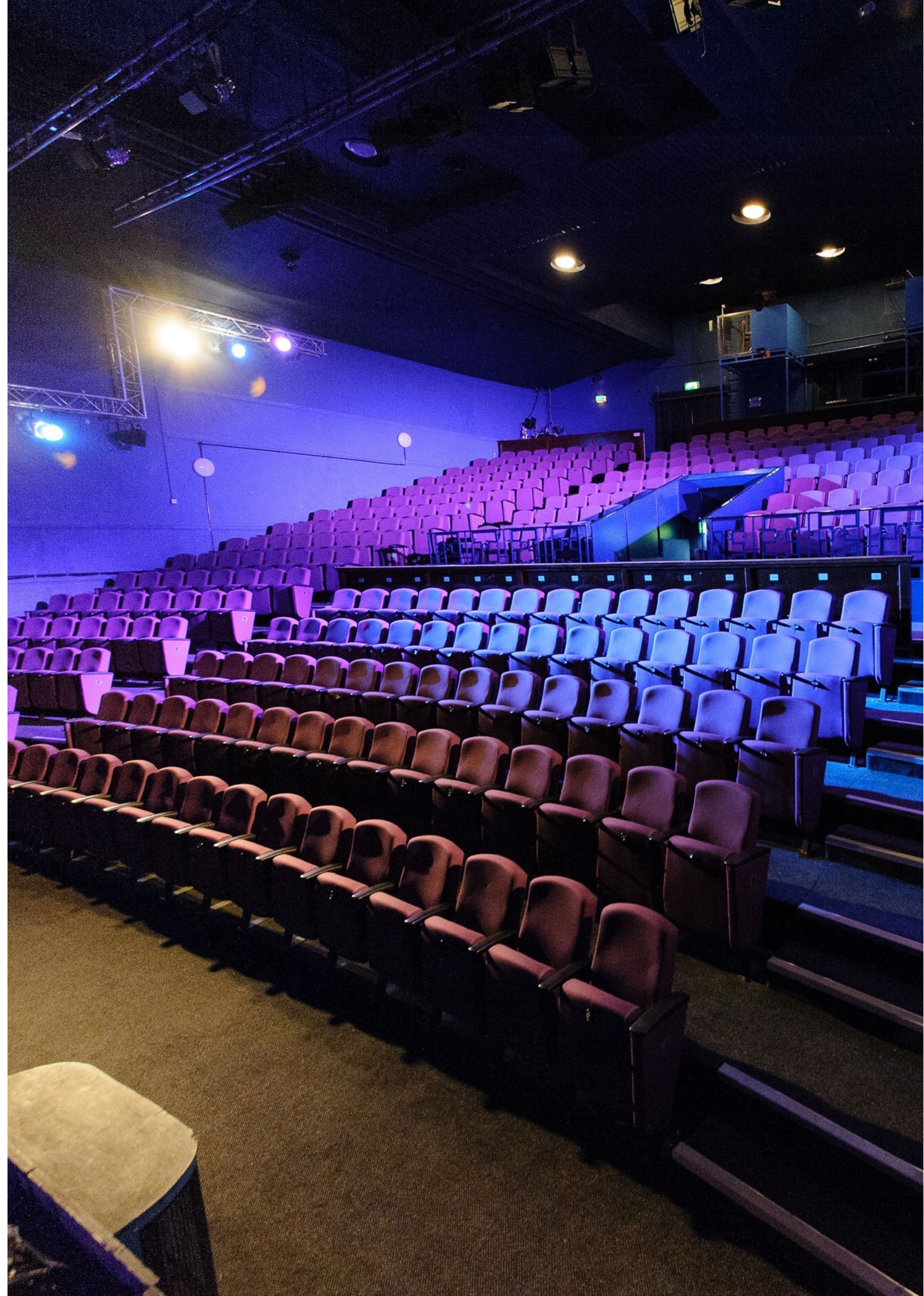
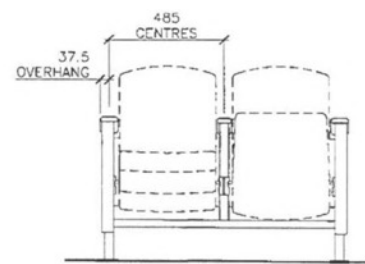
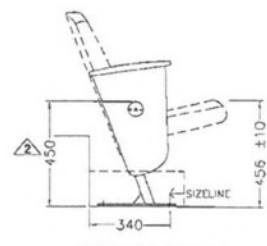

LOCHSIDE THEATRE

ATLANTIC SEAT

The Fullarton, formerly the Lochside Theatre is a professionally equipped theatre in the heart of south-west Scotland. The theatre utilises a building which was converted from St Andrews Church in 1996. Opening 13 years ago, the theatre continues to present entertainment both from professionals and in-house, and local performance groups.

Lochside is an entertainment venue located in the former St Andrew's church which was converted in 1996. Within the theatre is a 172 seat auditorium, which provides facilities suitable for performance, cinema, conference, lecture or large meetings.

The Primera Atlantic auditorium seat was chosen for its durability, comfort and ease of maintenance. It is a seat which is perfect for maximising seating capacity as it has a compact envelope.

2020 / Seats: 172
UK

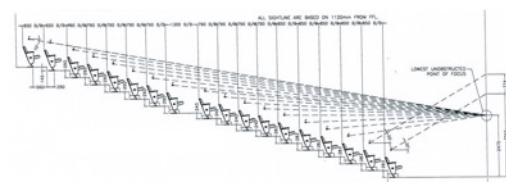
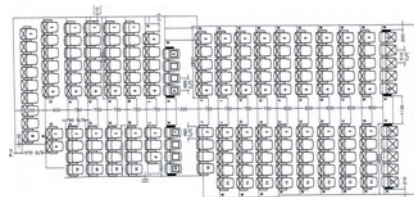

PACIFIC

GENERAL DESCRIPTION

The Pacific is the theatre seat of choice where comfort and durability are the primary concerns. Its compact envelope allows for ease of access and egress and the extensive backrest options ensure the maximum comfort and function.

Designed to be comfortable and maintenance free throughout its lifetime, this seat provides levels of comfort far beyond its size.

Cold cure moulded foam ensures long lasting comfort while the polyurethane armrests will outlast all those in fabric. The moulded foam cushions wrap the support springs in an airtight cocoon preventing both noise and corrosion.

PRODUCT DETAILS

Backrest

Inner panel is made of 13 mm thick press curved plywood, upholstered with polyurethane high resilience foam of 75- 100mm thickness, density 45kg/m³ with fabric covers.

Fully upholstered outer back.

Seat

Rectangular shape, tapered front end, tip-up. Inner structure made of Ø21mm x Thk. 2mm tubular steel frame with grid foundation, integrated in high resilience foam, density 60kg/m³.

Upholstered with padded cover.

Tip-up seat with counterweight systems and being lift-up by means of gravity. Totally silent and maintenance free.

Armrest

Fixed, shared armrest with a curved design.

Top part made of black polyurethane.

Decorative aisle panel made of MDF board and upholstered with padded covers.

Metal Finishing

All metal parts exposed shall be stripped and cleaned with iron phosphate, hot water rinsed and then chromic acid rinsed.

All metal parts are coated with an epoxy finish of at least 60 microns for indoor use.

Conformity with BS-6496 hardness test.

Standards

Centre and end standards are of lateral pedestal design made of 38mm x 38mm xThk 2.3mm square hollow section continuous welded to a 6 mm thickness steel plate.

Fire Safety

Fire Safety - Flammability compliance with California Bulletin 117 and international regulations in their last issues and particularly with safety regulations.

Flammability compliance with BS 5852 : 2006 Section 3 Ignition Source 0 & 1.

Options

Row lettering type A

Row lettering type E with Aisle light

Round row letter

Embroidery logo

Embroidery seat numbering

Diffuser leg

Tandem removable leg

Free standing leg

Castor wheel

A.D.A Panel

Wrimatic lite

Wooden outer back / seat outer

Wooden / upholstered armrest

Wooden panel

Probax

Flammability compliance with BS 5852 : 2006 Section 3 Ignition Source 5



Diamond Valley College - Australia

(1) 720 / (2) 760

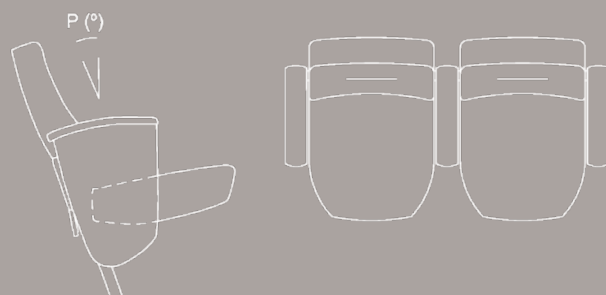

(1) 500 / (2) 535

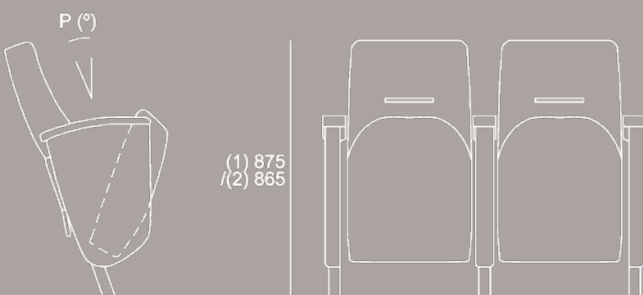

480 / 510 / 535
/ 560 / 585 / 610

(1) 875
/ (2) 865

P (°) = (1) 16° / (2) 20°



ST GEORGE PARK FA CENTRE AUDITORIUM

PACIFIC SEAT

2012 / Seats: 86

UK

Built in 2012, St George's Park is home to England's 28 national teams and delivers all national coach education courses.

It is set in 330 acres of Staffordshire countryside and has 13 outdoor pitches, a full indoor pitch and a suite of rehabilitation and sports science areas.

St. George's Park provides a unique setting for developing high performing teams and leaders. As part of the long term FA Education vision, it offers a broad range of accredited courses for coaches, referees, medics and administrators.

The Hilton Hotel complex boasts a lecture theatre, which is used for training, press conferences, corporate hire and performance analysis. Ferco installed the Primera Pacific auditorium seating which is renowned for its comfort and durability. It has a compact envelope which allows for easy access and an extensive range of backrest options to ensure guest comfort. It is specifically designed to be comfortable and maintenance free throughout its lifetime.

St George's chose to pair the integrated writing surface to provide multiple uses of the room.



FRANKSTON HS AUDITORIUM

PACIFIC SEAT

Frankston is a co-educational high school in Melbourne, Australia.

Renowned as an academic school of excellence with a strong, proud history of students graduating successfully with impressive results. Based on a large multi-campus the school boasts outstanding facilities and resources, including an audio-visual centre, senior study centre, music centre, indoor swimming pool and fitness centre.

The school also has a fully-equipped auditorium and drama studio. Frankston required new auditorium seating to match their student's aspirations. Ferco was happy to help. The school's motto is 'Optima Semper - Best Always', so Ferco provided its popular Primera Pacific theatre seat.

Its compact envelope allows for ease of access and egress and the extensive backrest options ensure the maximum comfort and function. Designed to be comfortable and maintenance-free throughout its lifetime, this seat provides levels of comfort far beyond its size.

The Pacific seat was further customised with a laminated wooden back, as per the client's preference; enhancing the entire design, whilst providing an extra layer of protection to each seat back.

They chose to upholster the seats in a range of different colour tones to complement the schools own colour scheme.

2020 / Seats: 395

Australia



FRANKSTON HS AUDITORIUM

PACIFIC SEAT

Riverview Church is a large, contemporary, multi-cultural and multi-generational community church in Perth, Australia. Ferco supplied 1,100 Pacific auditorium seats with customised pockets for hymn books.

The seating consists of linked seats (shared armrests), free standing seats (mounted on skids) configured in banks of two and three; and removable seating to allow for wheelchair spaces. Removable seating is positioned into a permanent floor fixing with quick release wing nut, making reconfiguration simple and time efficient.

Freestanding seats mounted on skids don't require any floor fixings and can also be quickly manoeuvred to a new location of choice. The Pacific is highly customisable. Available in 4 widths with the option of wooden, plastic or upholstered armrests. Wood can be added to the rear of the back rest, seat pan and aisle ends to help with acoustics and provide a tactile and natural aesthetic.

The pitch, or degree, of the back rest is changeable with the Pacific seat. This allows for optimised sight-lines throughout the auditorium.

Ferco can upholster seating in most fabrics finishes to meet the design brief. Performance spaces and theatres often prefer velour for a rich, sumptuous look whilst education facilities often specify polyester or natural wool fabrics. The seats at Riverview are upholstered here in Venus black fabric with zip off seat covers for easy replacement or cleaning.

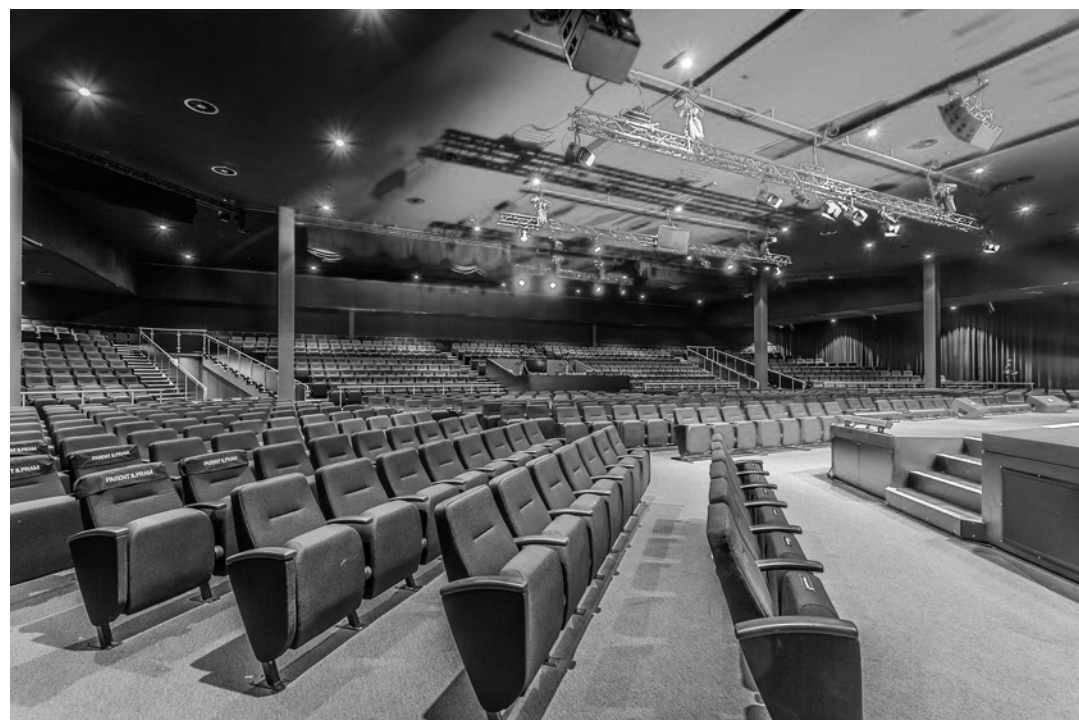

2020 / Seats: 1,100
Australia



TOKYO

GENERAL DESCRIPTION

The Tokyo is a luxurious armchair with a tilting seat and automatic return built for durability. It can be mounted in a row, with a central base, and armrest between two seats.

Its wide seat, high back and plush padding make it an ideal choice for both corporate and commercial auditoriums. The Tokyo has an extensive list of customisable features including built in cup holders and embroidery, perfect for a discerning audience.

PRODUCT DETAILS

Structure

Structure with prongs to set proper backrest angle, ranging from 4° to 37°. Seat pan articulation system by patented blade system. Especially silent soft close tip-up, no maintenance required.

Backrest and Seat

Ergonomic form with good lumbar support. Internal structure of 13.5mm - plywood with multiple layers and plastic sliding insert. Polyurethane fire-retardant foam, cold moulded, density of 25 to 30kg/m³. Seat is of polyurethane fire-retardant foam, cold-moulded, density of 50 to 55kg/m³, moulded onto a metal support.

Panel / Armrest

Internal wooden structure with polyurethane foam, density 118 kg/m³.

Metal and Fabric Finishing

All metal parts exposed shall be stripped and cleaned with iron phosphate, hot water rinsed, and then chromic acid rinsed.

All metal parts are with matte black finish of at least 60 microns, for indoor use.

Back and seat upholstery fabric with 3mm foam backing, finished with netting 15 g/m².

Backrest and seat cover are equipped with zipper.

Fire Resistance

Flammability compliance with California Bulletin 117 and international regulations in their last issue and particularly with safety regulations.

Other regulations such as EN 1021, BS 7176, BS 5852 – upon request.

Options

Cupholder

Seat numbering

Row lettering

Embroidery logo

K-Roll castor system.

Veneer varnishing wooden back outer



Teatre Borràs – Barcelona, Spain

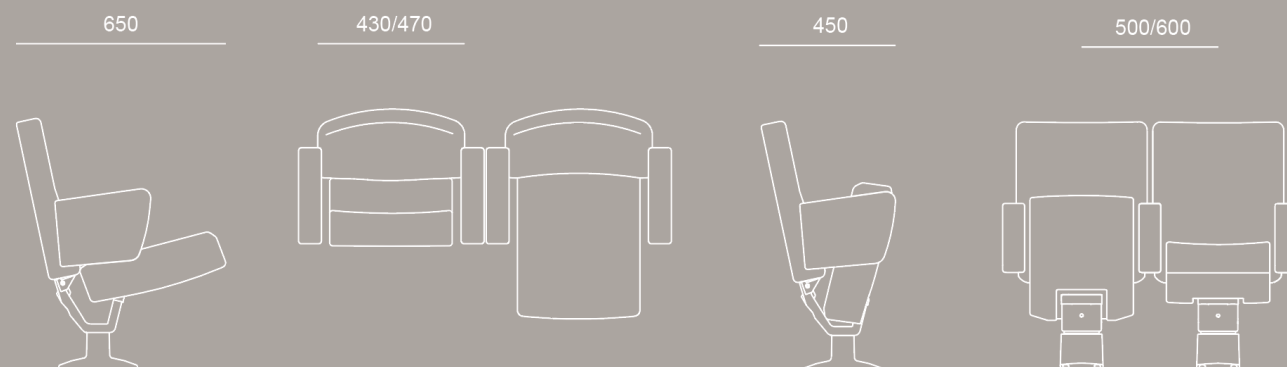

TEATRE BORRÀS

TOKYO SEAT

The Teatre Borràs is located in Plaça Urquinaona in Barcelona. It features classical and contemporary plays.

The Urquinaona Cinema opened its doors in 1931 and was later renamed Teatre Borràs in 1943. In 1953, it became part of Pedro Balañá's company, Grup Balañá, and was converted back into a cinema. However, in 1993, it was transformed again into a theatre. Ferco installed 432 Tokyo seats, maintaining the classic style while adding a modern touch.

The Tokyo seat complements the theatre's style seamlessly, creating a cohesive look. The seat has a sturdy build and a timeless design. The red Scenic velvet upholstery is adorned with small dots and metal plate numbering, giving the theatre a vintage touch.

2011 / Seats: 552
UK

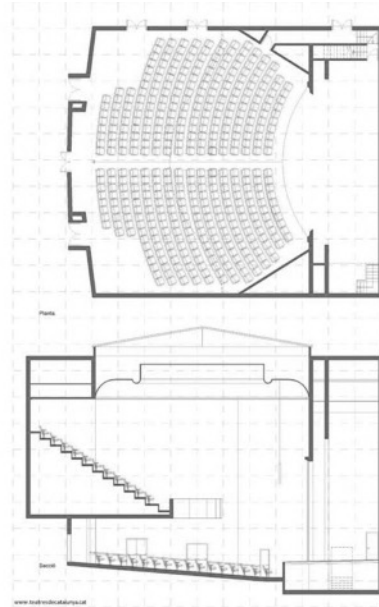



PRACTICAL SOLUTIONS

Functionality matters to us as much as design and comfort. We incorporate the latest technology in our products for a better experience.



EXPERTISE & KNOWLEDGE

Over 40 years of experience in seating industry with strong track record in delivering highest quality products and services worldwide.

WHY FERCO SEATING

At Ferco, our commitment to friendly, professional customer service and unwavering attention to detail is reflected in everything we do.



WORKING WITH ARCHITECTS

We have worked with prestigious architects such as Zaha Hadid, Franck Gehry... Our team incorporates designers and architects for a fluid follow-up.



PEACE OF MIND

We have an efficient team based in the UK committed to exceed customers' expectations. Around the clock after-sales service.



