

Daylight for living

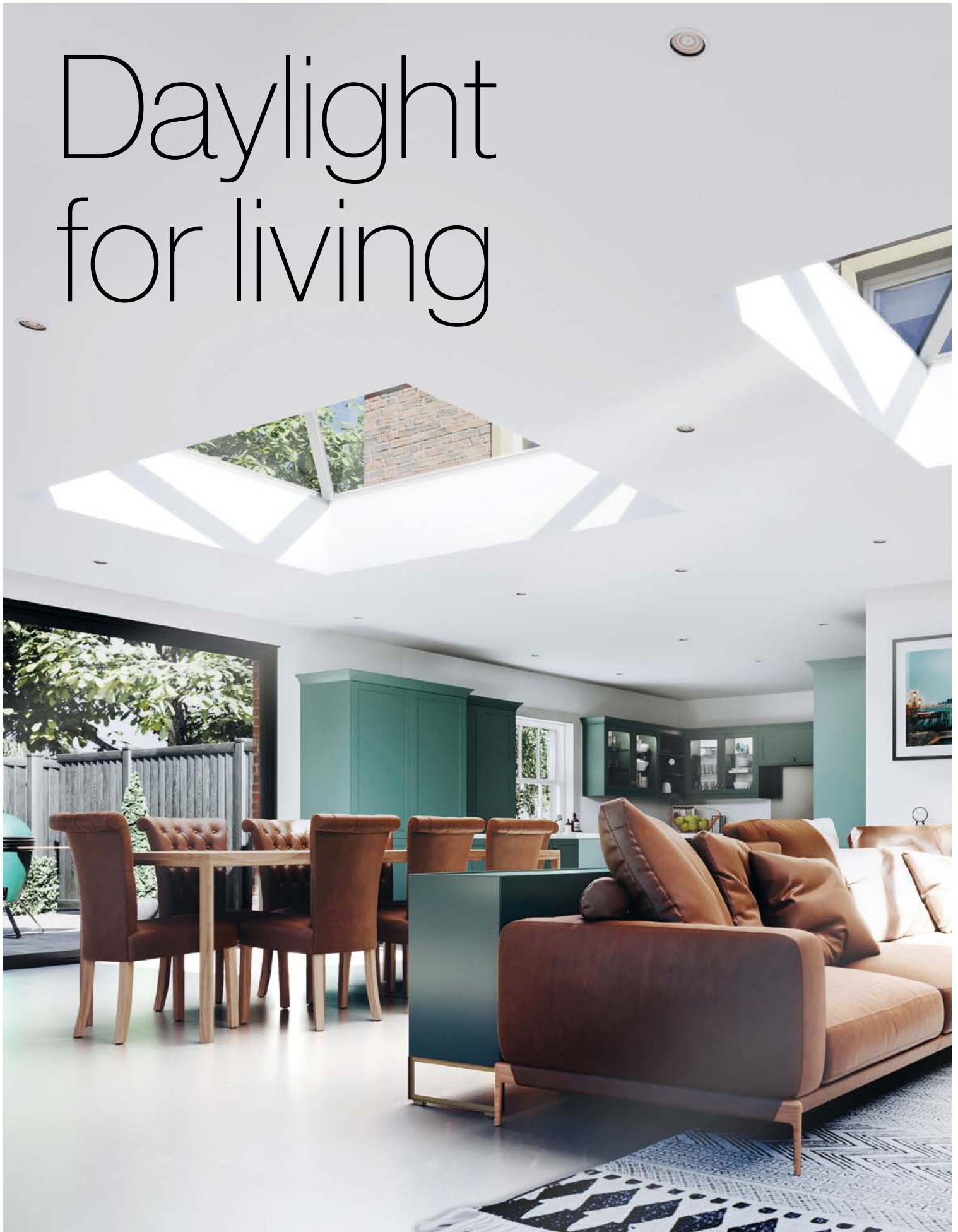

Choose Light

Don't compromise on quality

Brett Martin's sophisticated range of flat glass rooflights and roof lanterns add light and life to your home, with the peace of mind that comes with dealing with a leading UK expert in daylight systems. We are passionate about the impact of natural light on living spaces and the positive impact it has on the lives of those making their home there.

Our vast experience in creating daylight systems in every conceivable setting brings a depth of expertise shared by few, making us the ideal source for the right solution to add value to your homes.



Safer

Brett Martin: where the safest choice is standard.

We never compromise on your safety, so you won't have to make a choice on what's best for your family.

Every glass rooflight we produce features high performance glazing units with laminated inner panes, the only safe choice for overhead glazing.*

Laminated inner panes prevent glass falling into the building when accidentally broken, by a falling object for example. This additional safety feature offers peace of mind over other glass rooflights on the market which feature unsafe* toughened glass inner panes.



Laminated
Glazing as
standard



*In accordance with Rooflight Association guidance

Choose your *style*

Brett Martin produces a daylight system for every application and home style.

Whether adding space to a period terrace, creating indoor/outdoor living in a family home or building your grand design, we have a suitable solution to fill your property with daylight.

To simplify your build, our glass rooflights are available in just days from a wide range of standard sizes which satisfy most projects. Should you require a bespoke solution, however, our customer service team will handle your enquiry promptly.

Our products are designed and manufactured in the UK to exceed the latest standards for energy efficiency, safety and technical performance.

Our team is always available and happy to help you find the optimum rooflight for your home.

With a 10 year warranty available across the range, you can enjoy extra peace of mind when you choose Brett Martin.

10 YEAR
WARRANTY
AVAILABLE

Roof Lantern

Add visual interest to key living and dining areas with a choice of contemporary 4 panel Lantern or a more traditional 6 panel configuration, complementing any style of property.

Available in sizes up to 3000mm x 2000mm.*

Bespoke sizes also available.

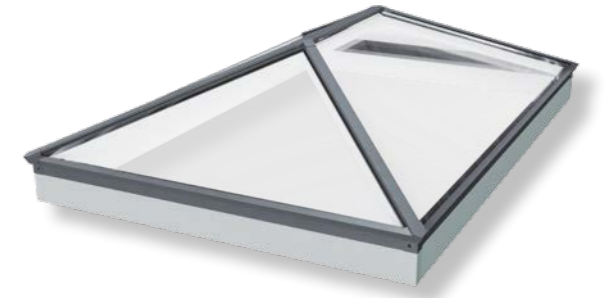

Flat Glass

Ideal for modern living the Flat Glass range can be installed in single large square or rectangular formats or as a group of smaller rooflights.

Available in sizes up to 3600mm x 1650mm with options available for openings and ventilation.*

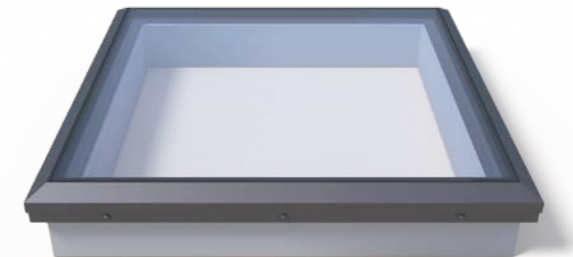

Circular Glass

An interesting option to provide central feature daylighting or as a striking way to counteract darker areas.

Available in sizes up to 1500mm diameter.*

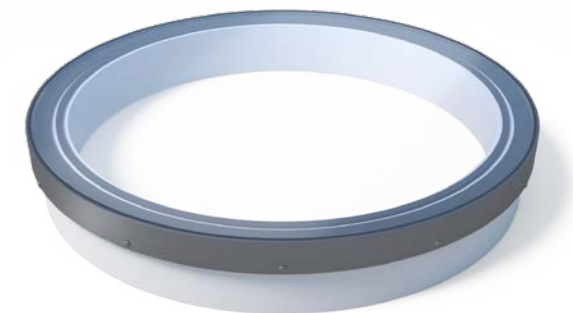

Glass Link

The options are endless for this continuous modular rooflight system, creating multiple design features for larger projects.

Available in spans of up to 3800mm, with options for opening ventilation.*

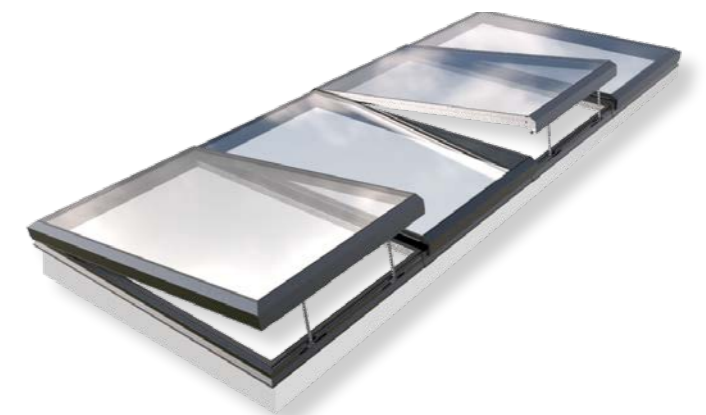

*Image shown with 'Builder's Upstand' (not supplied).

Lantern



Brett Martin brings roof lanterns to a new level.

With slimline profiles, the Brett Martin Roof Lantern's ultra fine detailing provides an attractive appearance whilst allowing more daylight to penetrate your living space.

With standard sizes of up to 3m x 2m available as well as bespoke options, this stylish roof lantern can transform even the most substantial of extension projects.





MORE LIGHT, YOUR WAY.

The natural light provided by a Brett Martin Roof Lantern is an essential addition to extended living areas, enhancing the quality of your space, letting you access the proven benefits of exposure to daylight and a connection with the natural environment.

Choose to add light in a way which suits your property, with a variety of sizing and glazing options available.

Brett Martin's Contemporary 4 panel roof lantern design minimises the structure to maximise the daylight, while our Classic 6 panel design features additional glazing bars for a more traditional style.

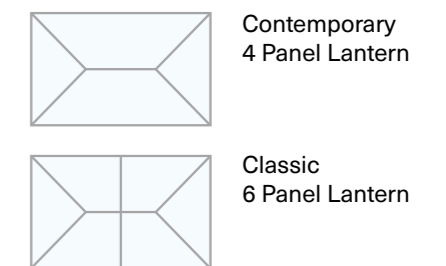

Higher Performance



SAFE
EASY
EFFICIENT



Our roof lantern is designed not only to look better but also to perform better in terms of safety, energy efficiency and lower maintenance.

Because we prioritise the safety provided by every lantern, we only supply glazing units with laminated inner panes

for protection from falling glass if accidentally broken.

The design of the slimline aluminium profiles has been optimised to work in conjunction with the thermally efficient double glazed units, reducing heat loss, protecting the energy efficiency of your home.

Engineered for performance

Expertly designed to minimise the number of parts, maximising the ease of fitting, for efficiency now and throughout the lifetime of the lantern.

Precision design removes the need for sealants in installation, apart from the contact of the kerb bar to the builders upstand.

Laminated inner panes are standard, prioritising the safety of those below.

Innovative base frame design, provides an effective drip edge for superior weathertightness.

Precision castings at all junctions provide premium appearance, strength, weathertightness and security.

Super slim bar depth of just 60mm, maximises the light transmission into the space below.

Pre-machined holes and slots throughout, maintains the integrity of the components and provides fast, easy assembly.

Co-extruded gaskets on inner bars eliminates 'gasket slip' during installation, ensuring weathertight glazing.

Easy-fit glass stops, hook on to the kerb bar, simplifying the glazing process.

The Brett Martin Roof Lantern is a hassle free way to improve the amount of daylight reaching your living area.

By reducing the number of parts required and the need for sealants within the lantern, we have simplified the installation process for a low maintenance, weathertight solution. A laminated inner pane ensures safety is a top priority for your home.

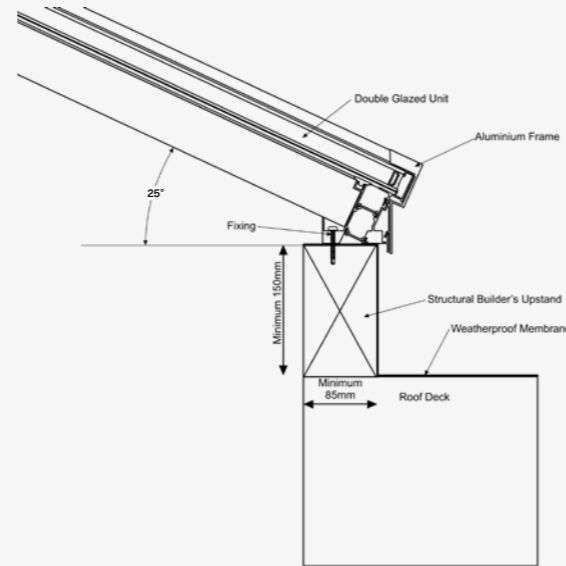

Innovative product design facilitates simple but effective, watertight installation.

Precision aluminium castings

Slender aluminium frame

Laminated inner pane

Available in clear or blue solar control glazing options with self-clean coating

Low-E insulated double glazing

Aluminium frame powder coated internally and externally in combinations of RAL 7016 grey, RAL 9010 white and RAL 9005 black

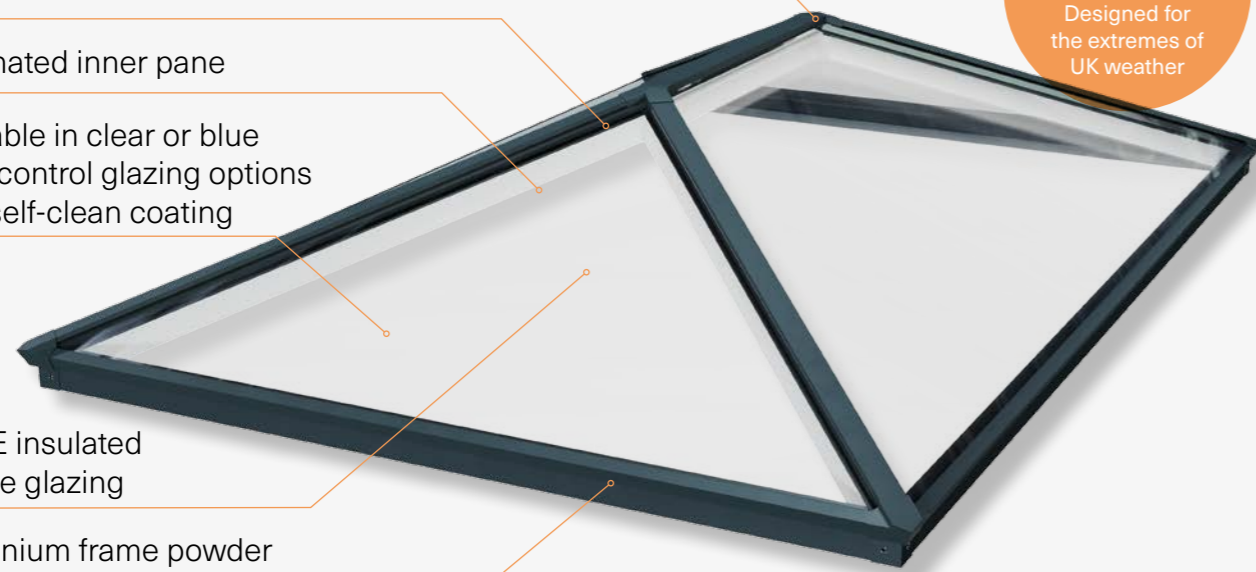

Glazing (Vertical)

10 YEAR WARRANTY AVAILABLE

PRODUCT OPTIONS

Standard Sizes

Contemporary 4 Panel Lantern

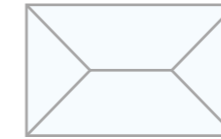

- 1500mm x 1000mm
- 2000mm x 1000mm
- 2000mm x 1500mm
- 2500mm x 1000mm
- 2500mm x 1500mm
- 2500mm x 2000mm
- 3000mm x 1000mm
- 3000mm x 1500mm
- 3000mm x 2000mm

Classic 6 Panel Lantern

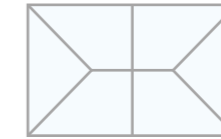

- 1500mm x 1000mm
- 2000mm x 1000mm
- 2000mm x 1500mm
- 2500mm x 1000mm
- 2500mm x 1500mm
- 2500mm x 2000mm
- 3000mm x 1000mm
- 3000mm x 1500mm
- 3000mm x 2000mm

Glazing

- Standard
- Clear self-clean
 - Blue Solar self-clean
- Options
- Aqua solar self-clean
 - Neutral solar self-clean

Frame Colour

Aluminium frame powder coated internally and externally in combinations of RAL 7016 grey, RAL 9010 white and RAL 9005 black.

Rapid single point delivery in 3-5 days from order (standard sizes only).

Bespoke Sizes

Bespoke sizes available. Typically delivered in 15-17 days.



Flat Glass



THE MODERN ALTERNATIVE



The Brett Martin Flat Glass range is the ideal source of daylight for use in a wide range of applications in modern homes.

Suitable for use as a large central light source over dining or living spaces in square or rectangular formats, they are also ideal for use in multiples in smaller sizes throughout a space for dramatic impact and optimum spread of light.

The stylish minimal design provides a safe yet unobtrusive means of bringing light deep into extended spaces for an enhanced living experience.

Add an additional source of fresh air to your living space with options for manual and electric opening options or trickle ventilation to maintain a streamline appearance. For further enhancement, choose solar control, tinted or obscured glazing to achieve your desired finish.

Choose Flat Glass for the optimum safe and secure daylighting option.

With a laminated inner pane as standard, we prioritise the safety of your family by ensuring accidental breakage will not lead to falling glass.

Our Flat Glass rooflights achieve Secured by Design accreditation*, ensuring you are kept secure against burglary.

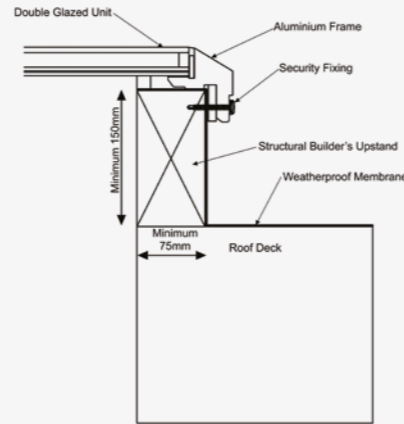

Innovative product design facilitates simple but effective, watertight installation.

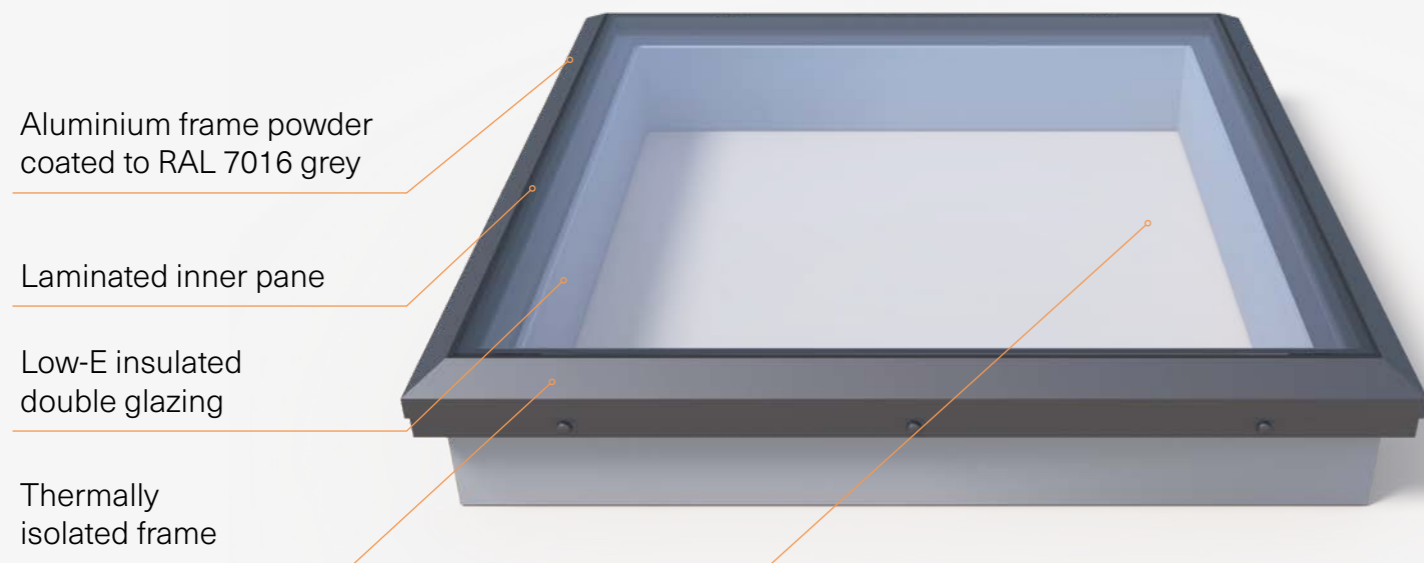

Clean internal appearance including hidden actuators and cables on powered opening rooflights

Image shown with 'Builder's Upstand' (not supplied). PVC kerb option available to order.



Glazing (Vertical)



PRODUCT OPTIONS

Sizing Options

Available in over 100 size options and bespoke sizes. Rapid delivery range available in as little as 48 hours in below sizes:

- 600mm x 600mm
- 750mm x 750mm
- 900mm x 600mm
- 900mm x 900mm
- 1000mm x 1000mm
- 1200mm x 600mm
- 1200mm x 900mm
- 1200mm x 1200mm
- 1500mm x 1000mm

Specifications

- Opening
- Fixed (Secured by Design)
 - Manual
 - Powered

- Ventilation
- Unvented
 - Hit & miss
 - Auto hit & miss

- Kerbs
- No kerb (builder's upstand)
 - 150mm uPVC kerb
 - 300mm uPVC kerb

Glazing Options

Non standard glazing options are available to order and include solar control, self cleaning and satin obscure glass.



Circular



EXPRESS
YOURSELF

Stand out from the crowd with a Brett Martin Circular Glass rooflight.

A contemporary look is achieved with this streamlined circular design featuring a slim and minimalist framework.

Our Circular Glass rooflight provides an interesting option for central feature daylighting or as an overhead addition in

darker areas. With diameters available from 600mm through to 1500mm, this premium rooflight range can enhance spaces from small bathrooms through to large living areas.

As well as offering an elegant aesthetic, this solution provides a practical, hassle free experience for your build schedule, with easy installation and maintenance achieved and quick delivery on stock sizes.

Choose Circular Glass to achieve visual impact for modern living spaces.

Choose from a range of sizes and mount onto a builder's upstand or complete with a pre-fabricated insulated GRP kerb.

A laminated glass inner pane gives piece of mind for those occupying the space below, ensuring no falling glass if accidentally broken.

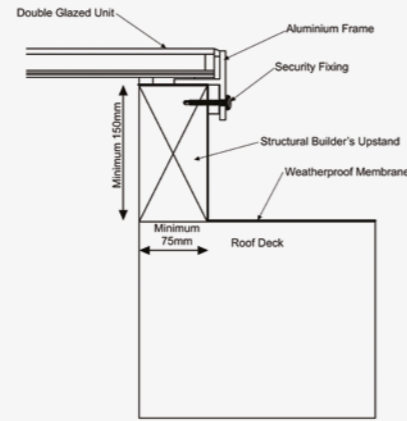

Innovative product design facilitates simple but effective, watertight installation.

Aluminium frame powder coated to RAL 7016 grey

Laminated inner pane

Low-E insulated double glazing

Thermally isolated frame

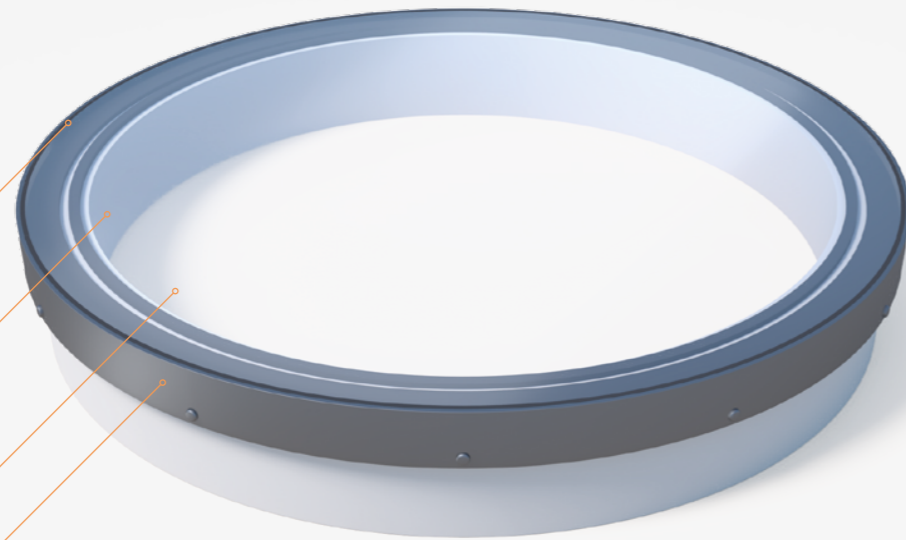

Image shown with 'Builder's Upstand' (not supplied). GRP kerb option available to order.



PRODUCT OPTIONS

Sizing Options

- 600mm
- 750mm
- 900mm
- 1050mm
- 1200mm
- 1350mm
- 1500mm

Options

Glazed unit only
Apply to an existing builder's upstand

Insulated GRP Kerb
150mm height



Glazing

Non standard glazing options are available to order and include solar control, self cleaning and satin obscure glass.

Finish Options

Can be powder coated to any single RAL colour on request.



Glass Link



LIGHT
WITHOUT
LIMITATION



Design daylight into your dream home with Brett Martin's Glass Link rooflight system.

This elegantly designed continuous modular rooflight offering provides a striking addition to large and linear spaces.

Options are limitless, with spans of up to 3800mm available with individual modules 3800mm x 1750mm allowing for uninterrupted daylight.

Choose from fixed or opening window options or combine a mix of both without altering your streamline look. All modules, including opening options, are flush and deliver a clean, slimline appearance allowing you to maximise natural light with minimal framing.

Glass Link provides the flexible approach to installing daylight into the home.

With a combination of fixed and opening modules available, even the largest of areas can be transformed with natural daylight and fresh air.

With laminated rather than toughened glass chosen for inner panes as standard, your safety is always our priority.

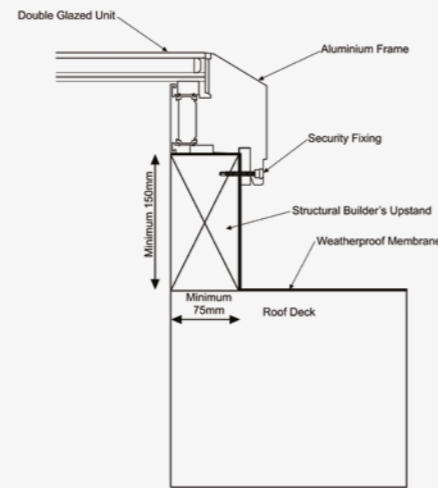

Innovative product design facilitates simple but effective, watertight installation.

Aluminium frame powder coated to RAL 7016 grey externally and RAL 9010 white internally

Laminated inner pane

Flush powered opening modules so fixed and opening modules appear identical

Thermally broken frame

Low-E insulated double glazing

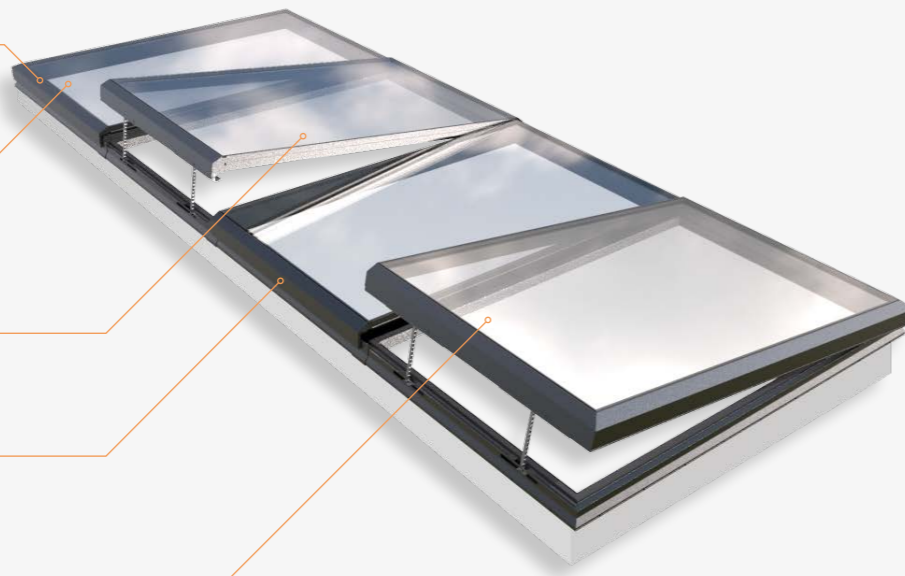

Image shown with 'Builder's Upstand' (not supplied).



Glazing (Vertical)



PRODUCT OPTIONS

Sizing Options

Spans of up to 3800mm available – individual modules of up to 3800mm x 1750mm to allow for uninterrupted daylight.

Size restrictions apply for opening options due to size, wind loadings and weight.

Opening Options

A range of static and opening options available as follows:

- Fixed (Secured by Design)
- Manual opening - pole operated worm drive
- Powered opening - wall-switch (concealed chain actuator)
- Powered opening - remote controlled operation
- Powered opening - rain sensor operation

Glazing Options

Non standard glazing options are available to order and include solar control, self cleaning and satin obscure glass.

Finish Options

Can be powder coated to any single RAL colour on request.



Brett Martin
Daylight Systems Ltd
Sandford Close
Aldermans Green Industrial Estate
Coventry, West Midlands
CV2 2QU

3017/0524

t: +44 (0) 24 7660 2022
f: +44 (0) 24 7660 2745
e: daylight@brettmartin.com

For the latest information visit
brettmartin.com

