

# GUY-RAYMOND



## GRX CASTORS

Rollen ■ Roulettes ■ Ruedas



- Started 1948
- Family owned
- Manufacturer
- In-House CAD
- In-House R&D
- Multilingual Export Dept
- Exports to 40 countries
- ISO 9001
- ISO 14001



- Gegründet 1948
- Familienbetrieb
- Hersteller
- In-Haus CAD
- In-Haus Entwicklung
- Mehrsprachiges Export Team
- Export in 40 verschiedene Länder
- ISO 9001
- ISO 14001



- Société fondée en 1948
- Entreprise familiale
- Fabricant
- CAD sur place
- R&D sur place
- Equipe export multilingue
- Nous exportons vers 40 pays
- ISO 9001
- ISO 14001



- Empresa fundada en 1948
- Negocio familiar
- Fabricante
- CAD en casa
- I+D en casa
- Equipo de exportación plurilingüe
- Exportamos a 40 países
- ISO 9001
- ISO 14001



**GUY-RAYMOND ENGINEERING COMPANY LIMITED**  
 ROLLESBY ROAD • KING'S LYNN • NORFOLK. PE30 4LX ENGLAND

TEL: 01553 761401  
 FAX: 01553 767459  
 WEB: [www.guy-raymond.com](http://www.guy-raymond.com)

TEL INT: +44 1553 761401  
 FAX INT: +44 1553 767459  
 E-Mail: [info@guy-raymond.co.uk](mailto:info@guy-raymond.co.uk)



# CONTENTS

## GRX TECHNOLOGY

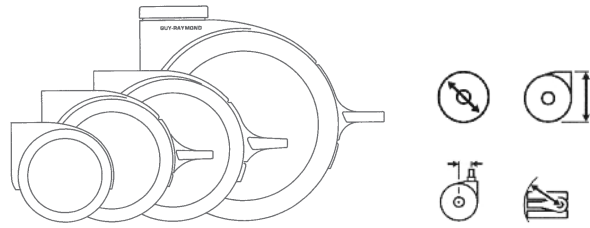

4 - 5

## GRX30 RANGE



6 - 7

## GRX50 RANGE



8 - 15

## GRX GLIDES



16 - 17

## GRX65 RANGE

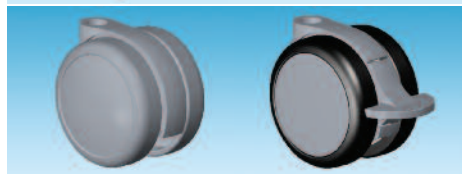
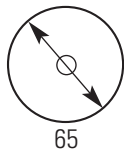

18 - 43

## GRX75 RANGE

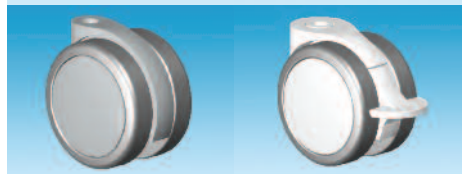
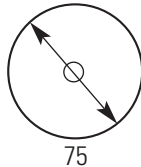

44 - 57

## GRX100 RANGE

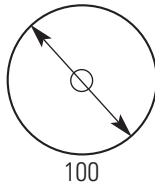

58 - 71

## GRX125 RANGE

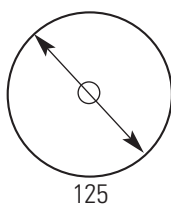

72 - 79

## GRX ANTIMICROBIAL

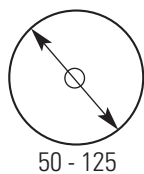

80 - 87

## ACCESSORIES



88 - 89

## TERMS AND CONDITIONS

GUY-RAYMOND ENGINEERING COMPANY LIMITED  
TERMS AND CONDITIONS OF SALE

- 1. THE CONTRACT**  
These conditions shall form part of every contract of sale entered into by Guy-Raymond Engineering Company Limited (the Company) and any purchaser, retailer or customer (the Buyer) entered into in the course of the trade or otherwise, whether or not the Buyer is acting in writing by an authorized representative of the Company.
- 2. ORDER AND SPECIFICATIONS**  
2.1 All order whether or not based upon a quotation shall not be binding on the Company unless accepted in writing by an authorized representative of the Company and other goods are specified upon the Company's invoice to the Buyer.
- 3. TITLE**  
Title to the goods shall remain with the Company until such time as title to the goods is to pass to the Buyer and payment is received under the terms of the said agreement.
- 7.2** The responsibility between the Company and the Buyer shall be governed by the terms and conditions of sale, the goods delivered to the Buyer in the event that the goods are delivered to the Buyer in the event of a sale under clause 7.2. The Buyer's responsibility for the Company's products (GPR) shall be limited to the proceeds thereof and without prejudice to the above, the Buyer shall hold the said proceeds of sale for the Company in a separate bank account opened for the purpose to make or complete payment for the goods.

90

## ADVANTAGES

- Unique design enhances product appeal
- 2 year guarantee
- Quality product ISO 9001
- Complies to EU standards EN 12528 / 12529 / 12530
- Total lock option on GRX75, GRX100 and GRX125
- High quality materials - PA for strength and durability, polyurethane tyres for long life
- Tested in Germany at the LGA Test Institute
- Short lead times - rapid assembly and despatch

## VORTEILE

- Einzigartiges Design – ergänzt Ihre Produkte
- 2 Jahres Garantie
- Konsistente Qualität durch ISO 9001
- Entspricht EU Standard EN 12528 / 12529 / 12530
- GRX75, GRX100 und GRX125 mit Totalfeststeller erhältlich
- Hochwertige Materialien – PA für Stärke und Stabilität, Polyurethan Lauffläche für langes Leben.
- In Deutschland geprüft – von dem LGA Prüfinstitut
- Kurze Lieferzeiten durch schnelle Montage und Versand

## AVANTAGES

- Design unique rend vos produits plus attrayants
- Garantie de 2 ans
- Produit de qualité - ISO 9001
- Conforme aux normes européennes EN 12528 / 12529 / 12530
- Blocage total disponible pour la GRX75, GRX100 et GRX125
- Matières de haute qualité PA pour durabilité, Bandes souples en polyuréthane pour longévité
- Roulettes testées en Allemagne aux laboratoires du LGA
- Délais courts - production et expédition rapide

## VENTAJAS

- Diseño unico realzar sus productos
- Garantia de 2 años
- Producto de calidad - ISO 9001
- Conforme a las normas europeas EN 12528 / 12529 / 12530
- Traba total disponible para los modelos GRX75, GRX100 y GRX125
- Materiales de alta calidad PA (nilón) para resistencia y durabilidad, Rodadura blanda de poliuretano para longevidad
- Probado en Alemania en el laboratorio del LGA
- Plazos de entrega breves - Producción y envío rápido

REGISTERED DESIGN

REGISTRIERTER ENTWURF

DESIGN DEPOSE

DISEÑO REGISTRADO

## FEATURES

- Cutting edge design
- Patented dust/grease shield
- Polyamide structure
- Rivetted axle on GRX75, GRX100 & GRX125
- Twin retaining groove axles on GRX50 and GRX65 ranges
- Choice of colours
- Dual action brake pedal
- Low friction bearings fitted as standard to the GRX100B, GRX100BTL and GRX125 castors
- U.K. Patent Nr.2171897 and 2229912. Other patents pending.

## EIGENSCHAFTEN:

- Anspruchsvolles Design
- Patentierter Achsenschutz
- Polyamid Struktur
- Vernietete Achse bei Rollen GRX75, GRX100 und GRX125
- Verdoppelte Haftungsgrillen an der Achse der Rollen GRX50 und GRX65
- Farbauswahl
- Rad und Schwenkung-Feststeller
- GRX100B, GRX100BTL und GRX125 sind standardmäßig mit Kugellager erhältlich
- U.K. Patent Nr.2171897 und 2229912. Weitere Patente angemeldet.

## CARACTERISTIQUES

- Design moderne
- Capot de protection de l'axe contre la poussière - breveté
- Capot en polyamide
- Roues rivetées sur l'axe (GRX75, GRX100 et GRX125)
- Double rainure pour une fixation solide des roues (gammas GRX50 et GRX65)
- Un choix de couleurs
- Pédale de frein à double action
- Les roulettes GRX100B, GRX100BTL et GRX125 sont équipées en série de roulements à billes pour réduire la friction
- U.K. Patent Nr.2171897 et 2229912. Demande d'autres brevets déposées.

## ELEMENTOS

- Diseño moderno
- Protector del eje contra el polvo (patentado)
- Producto de nilón
- Ruedas remachadas en el eje (GRX75, GRX100 y GRX125)
- Ranura doble en el eje para tener las ruedas (gamas GRX50 y GRX65)
- Surtido de colores
- Pedal de freno de doble uso
- Las ruedas GRX100B, GRX100BTL y GRX125 son equipadas con cojinetes de bolas para reducir la fricción
- U.K. Patent Nr.2171897 y 2229912. Otras patentes en trámite.

## APPLICATIONS

- Medical equipment
- Diagnostic equipment
- Office furniture
- Mobile workstations
- Mobile storage units
- Domestic furniture
- Home office
- Shop and display
- Visual display
- Leisure equipment
- Kitchen storage

## EIGENSCHAFTEN:

- Medizinische Geräte
- Untersuchungsapparate
- Büromöbel
- Mobile Arbeitsplätze
- Mobile Schränke
- Home Office
- Ladenbau
- Displaytechnik
- Freizeit und Fitness Geräte
- Küchenmöbel











## APPLICATIONS

- Equipement médical
- Equipement diagnostique
- Meuble de bureau
- Postes de travail mobiles
- Meubles de rangement mobiles
- Meubles domestiques
- Bureaux domestiques
- Aménagement de magasin
- Equipement d'affichage
- Equipement de loisirs
- Meubles de rangement pour la cuisine

## USOS

- Equipo médico
- Equipo diagnóstico
- Mueble de oficina
- Estaciones de trabajo móviles
- Muebles de almacenamiento móviles
- Muebles domesticos
- Oficina de casa
- Equipo de tiendas
- Equipo de exposición
- Equipo de deportes
- Muebles de almacenamiento



PICTOGRAM MEANING	GRX LEGENDE	SIGNIFICANCE DES PICTOGRAMMES	SIGNIFICADO DE LA PICTOGRAMA	
	WHEEL DIAMETER	RADDURCHMESSER	DIAMETRE DE LA ROUE	DIAMETRO DE LA RUEDA
	OVERALL HEIGHT	GESAMTHÖHE	HAUTEUR TOTALE	ALTURA TOTAL
	TOWER SIZE	HALSDURCHMESSER	DIAMETRE DE L'OEIL	DIAMETRO DE LA TORRE
	TREAD WIDTH	BREITE DER LAUFLÄCHE	LARGEUR DE LA BANDE DE ROULEMENT	ANCHURA DE LA RODADURA
	OVERALL WIDTH	ROLLENBREITE	LARGEUR TOTALE	ANCHURA TOTAL
	CASTOR OFFSET	AUSLADUNG	DEPORT DE LA ROULETTE	OFFSET DE LA RUEDA
	SWEPT RADIUS	SCHWENKRADIUS	RAYON DE BALAYAGE	RADIO DE BARRIDO
	FITTING TYPE	BEFESTIGUNG	TYPE DE FIXATION	TIPO DE FIJACION
	BUILDING HEIGHT	BAUHÖHE	HAUTEUR DE MONTAGE	ALTURA DE MONTAR
	FITTING LENGTH	FIXIERUNGSLÄNGE	LONGUEUR DE LA FIXATION	LARGO DE FIJACION

LOAD CAPACITY	LASTFÄHIGKEIT	CAPACITE DE CHARGE	CAPACIDAD DE CARGA
 <p>When calculating the maximum load on each castor consider:</p> <p>A) The total weight of the unit to which the castor is being fitted.</p> <p>B) Any additional load which goes on or in the unit.</p> <p>C) The centre of gravity of the unit and additional loads.</p> <p>D) Due to uneven floors 3 castors will as a minimum support the load.</p> <p>E) Allow a safety factor in your calculation.</p>	<p>Um die maximale Last pro Rolle auszurechnen bedenken Sie</p> <p>A) das Gewicht Ihres Produktes,</p> <p>B) das maximale Gewicht der Ladung,</p> <p>C) der Schwerpunkt und weitere Ladungen.</p> <p>D) Wegen unebenen Böden sollen minimal drei Rollen die Last tragen können.</p> <p>E) Erlauben Sie einen Sicherheitsfaktor.</p>	<p>Pour le calcul de la charge maximum supportée par roulette il faut prendre en compte</p> <p>A)Le poids total de la pièce sur laquelle la roulette va être montée.</p> <p>B) Toute charge supplémentaire qui sera mise sur la pièce</p> <p>C) Le centre de gravité de la pièce et de toute charge supplémentaire. D) La charge peut être supportée par 3 roulettes à cause d'inégalité du sol. E) Prévoir un facteur de sécurité pour le calcul.</p>	<p>Para calcular la carga máxima de cada rueda, es necesario considerar</p> <p>A)El peso total del producto para lo cual la rueda será utilizada.</p> <p>B) Toda carga suplementaria que será en el producto</p> <p>C) El centro de gravedad del producto y toda carga suplementaria.</p> <p>D) La carga puede ser apoyada por 3 ruedas como mínima a causa de un suelo quebrado.</p> <p>E) Dejar un margen de seguridad en la calculación</p>

STANDARDS	NORMEN	NORMES	NORMAS
<b>EN12528</b> Castors for furniture	Möbelrollen	Roulettes pour meubles	Ruedas para muebles
<b>EN12529</b> Castors for swivel chairs	Stuhlrollen	Roulettes pour sièges de bureau	Ruedas para sillas de oficina
<b>EN12529</b> Castors for swivel chairs: 4.2.4 Type U (load dependent braking system, brakes operate only in the unloaded condition)	Rollen für Drehstühle: 4.2.4 Typ U (Rollen für Drehstühle mit einer lastabhängigen Bremse)	Roulettes pour sièges de bureau 4.2.4 Type U (système de frein automatique, le frein est engagé seulement sans charge)	Ruedas para sillas de oficina 4.2.4 Tipo U (sistema de freno automática, el freno engrana solamente sin carga)
<b>EN12530</b> Castors for manually propelled institutional applications	Apparaterollen, Manuell Betätigte Rollen	Roulettes pour équipements de collectivités manuels	Ruedas para equipamientos de colectividades

# GRX30 & GRX30FB CASTOR

## SPECIFICATION

### CASTOR TYPE

GRX30 Swivel  
GRX30FB Wheel Brake

### MATERIALS

Castor PA  
Hard Wheel PA  
Soft Tyre PUR

### STANDARD COLOURS

Black

### STANDARDS

EN 12528

## TECHNISCHE DATEN

### ROLLEN TYP

GRX30 Lenkrolle  
GRX30FB Radfeststeller

### MATERIAL

Rollen PA  
Harte Räder PA  
Weiche Lauffläche PUR

### STANDARDFARBEN

Schwarz

### NORMEN

EN 12528

## SPECIFICATION

### TYPE DE ROULETTE

GRX30 Pivotant  
GRX30FB Blocage de Roue

### MATIERES

Roulette PA  
Roue dure PA  
Bandes Souples PUR

### COLORIS STANDARD

Noir

### NORMES

EN 12528

## ESPECIFICACION

### TIPO DE RUEDA

GRNP30 Giratorio  
GRX30FB Rueda con freno

### MATERIALES

Rueda Nilón  
Rodadura dura Nilón  
Rodadura Blanda Poliuretano

### COLORES ESTANDAR

Negro

### NORMAS

EN 12528



30



30



14



9.5



40



15



35 & 42



50kg & 40kg (SOFT)

### NO.

4100-1

GRX30

BLACK - HARD WHEEL

4100-1-1U

GRX30 Soft Tyre

BLACK - SOFT TYRE

### NO.

4200-1

GRX30FB

BLACK - HARD WHEEL

HARD

SOFT

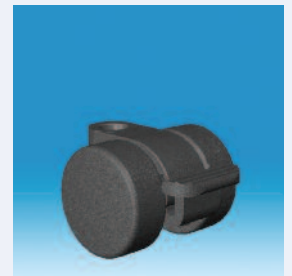
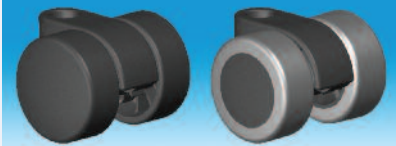

## GRX30 & GRX30FB FITTINGS

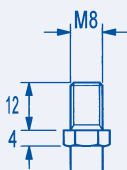

M8 x 12  
No.1900P

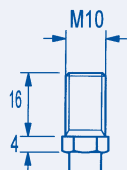

M10 x 16  
No.1906P

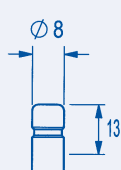

Ø8 x 13  
No.1910P

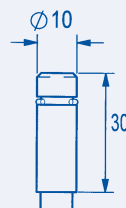

Ø10 x 30  
No.1911P

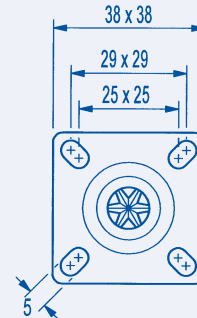

PLATE FIXING  
No.1902-9209

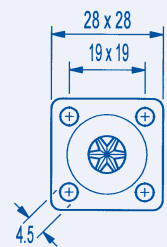
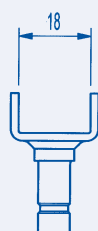

PLATE FIXING  
No.1901-9231



15mm "U" BRACKET  
No.9200-1901



18mm "U" BRACKET  
No.9201-1901

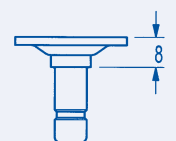
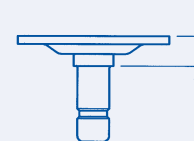
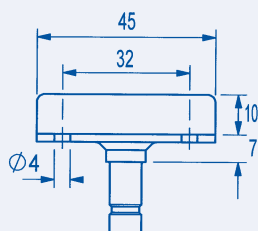

# GRX30 & GRX30FB WITH PLASTIC SOCKETS OR U BRACKETS

## SPECIFICATION

### CASTOR TYPE

Swivel GRX30  
Wheel Brake GRX30FB

### MATERIALS

Castor PA  
Soft Tyre PUR  
Socket & U Brackets  
Glass Reinforced PA  
Stem Steel BZP

### STANDARD COLOURS

Black

### STANDARDS

EN 12528

## TECHNISCHE DATEN

### ROLLEN TYP

Lenkrolle GRX30  
Radfesteller GRX30FB

### MATERIAL

Rollen PA  
Weiche Lauffläche PUR  
Hülse & U-Profil  
PA mit Glasfasern verstärkt  
Schraube Stahl verzinkt

### STANDARDFARBEN

Schwarz

### NORMEN

EN 12528

## SPECIFICATION

### TYPE DE ROULETTE

GRX30 Pivotant  
GRX30FB Blocage de Roue

### MATIERES

Roulette PA  
Bandes Souples PUR  
Douille & Etriers  
Polyamide renforcé de verre  
Tige Acier, plaqué de zinc

### COLORIS STANDARD

Noir

### NORMES

EN 12528

## ESPECIFICACION

### TIPO DE RUEDA

GRNP30 Giratorio  
GRNP30FB Rueda con freno

### MATERIALES

Rueda Nilón  
Rodadura Blanda Poliuretano  
Taco & Soportes  
Nilón de vidrio reforzado  
Vástago Acero, chapado de zinc

### COLORES ESTANDAR

Negro

### NORMAS

EN 12528



30



30



14



9.5



40

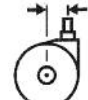

15



35 & 42



50kg & 40kg (SOFT)



### NO.

4144-1

GRX30 Ø8 x 13mm

30

13

**BLACK -  
HARD WHEEL**

4144-1-1U

GRX30 Soft Tyre Ø8 x 13mm

30

13

**BLACK -  
SOFT TYRE**



**HARD**

**SOFT**

### NO.

4244-1

GRX30FB Ø8 x 13mm

30

13

**BLACK - HARD WHEEL**



### NO.

93311014-8

8mm CASTOR SOCKET FOR 12mm HOLE

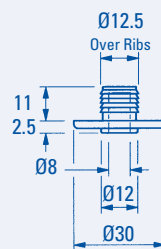

3 Countersunk  
Holes Ø3mm

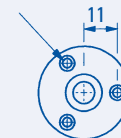

### NO.

93271014-8

93291014-8

93301014-8

### a

15mm Nylon "U" bracket - 8mm hole

16mm Nylon "U" bracket - 8mm hole

18mm nylon "U" bracket - 8mm hole

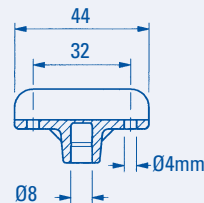
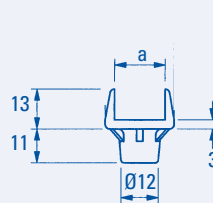



## INTRODUCTION

The GRX50 Range has a nominal wheel diameter of 50mm, and a load capacity of 40 kgs per castor. The castor is a freewheel swivel castor as standard and is available either with hard wheels or soft tyres. Hard wheels are recommended for soft floorings and soft tyres are recommended for hard floors. Further guidance is given in EN 12528 and EN12529. The range also is available with wheel brake.

## EINFÜHRUNG

Die GRX50 Rollen haben einen Raddurchmesser von 50mm und eine Lastfähigkeit von 40kg pro Rolle. Standardmäßig ist diese Rolle freilaufend mit harter oder weicher Lauffläche erhältlich. Für weiche Böden eignet sich die harte Lauffläche, für harte Böden empfehlen wir die weiche, mehr Infos dazu in den Normen EN 12528 und EN 12529. GRX50 ist auch mit Feststeller erhältlich.

## INTRODUCTION

Les roulettes de la gamme GRX50 ont des roues de diamètre 50mm, et supportent une charge de 40kg par roulette. Le modèle standard est une roulette non freinée, disponible avec roues dures ou bandes souples. Les roues dures sont recommandées pour sols souples et les bandes souples sont recommandées pour sols durs. Des conseils supplémentaires font partie des normes EN 12528 et EN12529. Ces roulettes sont disponibles aussi avec frein à pied.

## PRESENTACION

Las ruedas de la gama GRX50 tienen ruedas de diámetro 50mm, y una capacidad de carga de 40 kgs por rueda. El modelo estándar es una rueda sin freno, con rodadura dura o con rodadura blanda. La rodadura dura es recomendada para suelos blandos y la rodadura blanda es recomendada para suelos duros. Referirse a las normas EN 12528 y EN12529. Estas ruedas están disponibles también con freno a pie.

## FEATURES

- GRX Design
- Outer edge wheel radius of 6mm to reduce carpet wear
- Patented dust/grease shield
- Large fixing range
- Twin retaining groove axle
- Polyamide structure
- Polyamide soft tyre hub
- Polyurethane soft tyre

## EIGENSCHAFTEN:

- GRX Design
- 6mm Radkantenradius für Teppichschonung
- Patentierter Achsenschutz
- Viele Befestigungsmöglichkeiten
- Verdoppelte Haftungsringe an der Achse
- Polyamid Struktur
- Polyamid Rad
- Polyurethan weiche Lauffläche

## CARACTERISTIQUES

- Design GRX
- Roues arrondies avec un rayon de 6mm pour réduire les effets d'usure du sol
- Capot de protection de l'axe contre la poussière -breveté
- Gamme large de fixations
- Double rainure sur l'axe pour une fixation solide des roues
- Capot en polyamide
- Roues en polyamide
- Bandes souples en polyuréthane

## ELEMENTOS

- Diseño GRX
- Ruedas redondeadas con un radio de 6mm para reducir el desgaste del suelo
- Protector del eje contra el polvo (patentado)
- Gran gama de fijaciones
- Ranura doble en el eje para tener las ruedas
- Producto de PA (Nilón)
- Ruedas de PA (Nilón)
- Rodadura blanda de poliuretano



## APPLICATIONS

- Office furniture
- Office chairs (freewheel castor only)
- Domestic furniture
- TV / video / audio stands
- Shop and display
- Point of Sale stands
- Printer stands
- Home care furniture

## ANWENDUNGEN:

- Büromöbel
- Bürostühle (nur freilaufende Rollen)
- Wohnmöbel
- TV/Video/Hi-Fi Schränke
- Ladenbau
- POS Ständer
- Druckerständer
- Pflegemöbiliar

## APPLICATIONS

- Meuble de bureau
- Chaises de bureau (roulette non freinée)
- Meubles domestiques
- Meubles de TV / video / hi-fi
- Aménagement de magasins
- Etalages pour PDV
- Supports pour imprimants
- Mobilier HAD-MAD

## USOS

- Mueble de oficina
- Sillas de oficina (rueda sin freno)
- Muebles domesticos
- Muebles para TV / video / equipo de alta fidelidad
- Equipo de tiendas
- Estantes para punto de venta
- Estantes para impresoras
- Mobiliario para asistencia domestica

## FITTINGS

Guy-Raymond manufactures a wide range of standard fittings, these are shown on the opposite page. In addition Guy-Raymond can design and develop special fittings to customers requirements. Castors can be supplied assembled with certain popular stems and these are shown on pages 10 and 11.

## BEFESTIGUNGEN:

Guy-Raymond bietet viele verschiedene Befestigungsmöglichkeiten, welche Sie auf der nächsten Seite finden. Zusätzlich haben wir die Möglichkeit mit Ihnen eine Sonderbefestigung zu entwickeln. Die Rollen können in montiertem Zustand geliefert werden mit den populären Stiften auf Seiten 10 und 11.

## FIXATIONS

Guy-Raymond fabrique une gamme étendue de fixations standard – celles-ci sont présentées sur la page en face. De plus Guy-Raymond peut dessiner et développer des fixations spéciales pour correspondre aux besoins des clients. Les fixations courantes peuvent être fournies montées dans les roulettes et ces possibilités sont présentées sur les pages 10 et 11.

## FIJACIONES

Guy-Raymond fabrica una gran gama de fijaciones estándar – estas son presentadas en la página enfrente. Además Guy-Raymond puede diseñar y desarrollar fijaciones especiales según las necesidades de los clientes. Ruedas pueden ser suministradas montadas con las fijaciones más populares y estas posibilidades son presentadas en las páginas 10 y 11.

## SPECIFICATION

### MATERIALS

Steel BZP

## TECHNISCHE DATEN

### MATERIAL

Stahl Verzinkt

## SPECIFICATION

### MATIERES

Acier, plaqué de zinc

## ESPECIFICACION

### MATERIALES

Acero chapado de zinc

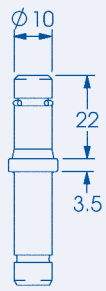

No.1957P

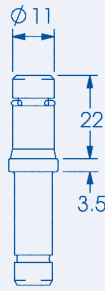

No.1954P

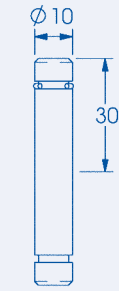

No.1950P

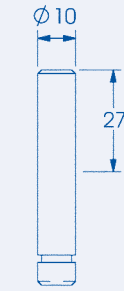

No.1966P

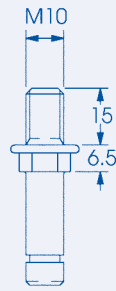

No.H552P

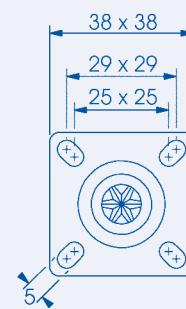

PLATE FIXING  
No.1959-9209

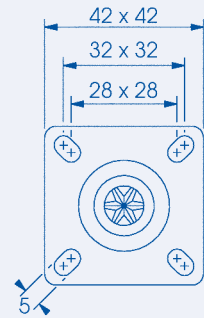
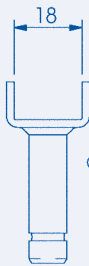

PLATE FIXING  
No.1959-9211



15mm "U" BRACKET  
No.9200-1958



18mm "U" BRACKET  
No.9201-1958

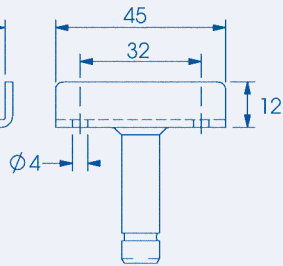

GRIPNECK SOCKET  
No.9243

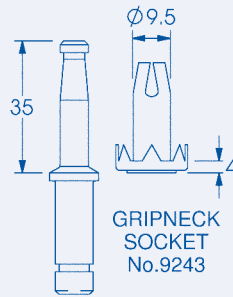

GRIPNECK STEM  
No.1990P

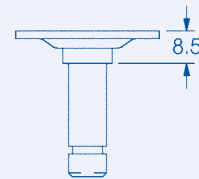

PLATE FIXING  
No.1959-9209

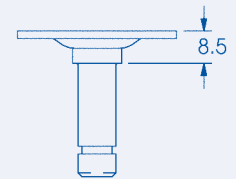
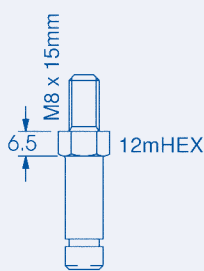

PLATE FIXING  
No.1959-9211



SCREWDRIVER SLOT



M8 x 15  
No.1946P

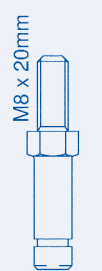

M8 x 20  
No.1947P

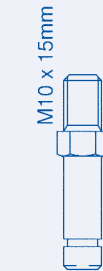

M10 x 15  
No.1955P

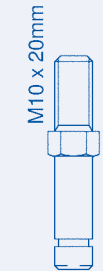

M10 x 20  
No.1962P

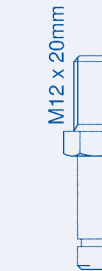

M12 x 20  
No.1983P



M10 x 25  
No.1963P

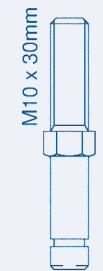

M10 x 30  
No.1945P

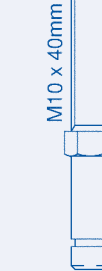

M10 x 40  
No.1968P



M10 x 55  
No.1855P

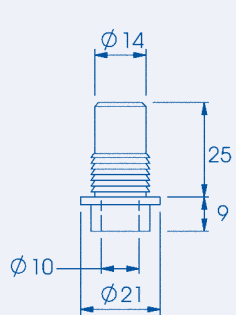

No.9309-1

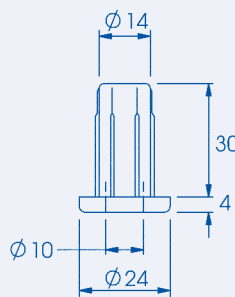

No.95301013

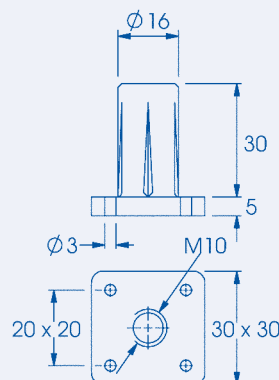

No.9541-1

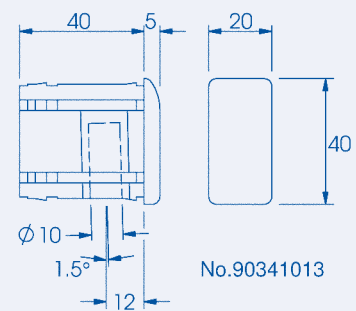

No.90341013

# GRX5018 CASTOR

## SPECIFICATION

### CASTOR TYPE

Swivel

### MATERIALS

Castor PA

Hard Wheel PA

Soft Tyre PUR

### STANDARD COLOURS

Black

Aluminium RAL 9006

### STANDARDS

EN 12528

EN 12529

## TECHNISCHE DATEN

### ROLLEN TYP

Lenkrolle

### MATERIAL

Rollen PA

Harte Räder PA

Weiche Lauffläche PUR

### STANDARDFARBEN

Schwarz

Aluminium RAL 9006

### NORMEN

EN 12528

EN 12529

## SPECIFICATION

### TYPE DE ROULETTE

Pivotante

### MATIERES

Roulette PA

Roue Dure PA

Bandes Souples PUR

### COLORIS STANDARD

Noir

Alu RAL 9006

### NORMES

EN 12528

EN 12529

## ESPECIFICACION

### TIPO DE RUEDA

Giratoria

### MATERIALES

Rueda Nilón

Rodadura Dura Nilón

Rodadura Blanda Poliuretano

### COLORES ESTANDAR

Negro

Plateado RAL 9006

### NORMAS

EN 12528

EN 12529



50



52.5



18



7



53

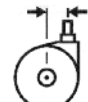

19



47.5



40kg



### NO.

6G00-1

6G03-1

6G08-1

6G01-1

6G20-1

6G02-1

6G04-1

6G51-1

-----

Ø 11 x 22mm

Ø 10 x 22mm

Ø 10 x 30mm

M8 x 15mm

M10 x 15mm

38 x 38mm Plate

42 x 42mm Plate

52.5

56

56

52.5

59

59

61

61

-

22

22

30

15

15

-

-

### BLACK - HARD WHEEL



### NO.

6G00-1-U

6G03-1-U

6G08-1-U

6G01-1-U

6G20-1-U

6G02-1-U

6G04-1-U

6G51-1-U

-----

Ø 11 x 22mm

Ø 10 x 22mm

Ø 10 x 30mm

M8 x 15mm

M10 x 15mm

38 x 38mm Plate

42 x 42mm Plate

52.5

56

56

52.5

59

59

61

61

-

22

22

30

15

15

-

-

### BLACK - SOFT TYRE



### NO.

6G00-64

6G03-64

6G08-64

6G01-64

6G20-64

6G02-64

6G04-64

6G51-64

-----

Ø 11 x 22mm

Ø 10 x 22mm

Ø 10 x 30mm

M8 x 15mm

M10 x 15mm

38 x 38mm Plate

42 x 42mm Plate

52.5

56

56

52.5

59

59

61

61

-

22

22

30

15

15

-

-

### RAL 9006 - HARD WHEEL



### NO.

6G00-64-64-T1U

6G03-64-64-T1U

6G08-64-64-T1U

6G01-64-64-T1U

6G20-64-64-T1U

6G02-64-64-T1U

6G04-64-64-T1U

6G51-64-64-T1U

-----

Ø 11 x 22mm

Ø 10 x 22mm

Ø 10 x 30mm

M8 x 15mm

M10 x 15mm

38 x 38mm Plate

42 x 42mm Plate

52.5

56

56

52.5

59

59

61

61

-

22

22

30

15

15

-

-

### RAL 9006 - SOFT TYRE



Ø 11 x 22mm



Ø 10 x 22mm



Ø 10 x 30mm



M8 x 15mm



M10 x 15mm



38 x 38mm Plate

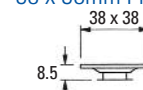

42 x 42mm Plate

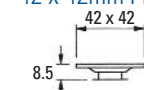



# GRX5018FB WHEEL BRAKE CASTOR

## SPECIFICATION

### CASTOR TYPE

Wheel Brake

### MATERIALS

Castor PA  
Hard Wheel PA  
Soft Tyre PUR

### STANDARD COLOURS

Black  
Aluminium RAL 9006

### STANDARDS

EN 12528

## TECHNISCHE DATEN

### ROLLEN TYP

Radfeststeller

### MATERIAL

Rollen PA  
Harte Räder PA  
Weiche Lauffläche PUR

### STANDARDFARBEN

Schwarz  
Aluminium RAL 9006

### NORMEN

EN 12528

## SPECIFICATION

### TYPE DE ROULETTE

Blocage de Roue

### MATIERES

Roulette PA  
Roue Dure PA  
Bandes Souples PUR

### COLORIS STANDARD

Noir  
Alu RAL 9006

### NORMES

EN 12528

## ESPECIFICACION

### TIPO DE RUEDA

Freno de Rueda

### MATERIALES

Rueda Nilón  
Rodadura Dura Nilón  
Rodadura Blanda Poliuretano

### COLORS ESTANDAR

Negro  
Plateado RAL 9006

### NORMAS

EN 12528



50



52.5



18



7



53

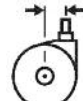

19



65



35kg



### NO.

6H00-1	-----	52.5	-
6H03-1	Ø 11 x 22mm	56	22
6H08-1	Ø 10 x 22mm	56	22
6H01-1	Ø 10 x 30mm	52.5	30
6H20-1	M8 x 15mm	59	15
6H02-1	M10 x 15mm	59	15
6H04-1	38 x 38mm Plate	61	-
6H51-1	42 x 42mm Plate	61	-

### BLACK - HARD WHEEL



### NO.

6H00-1-1U	-----	52.5	-
6H03-1-1U	Ø 11 x 22mm	56	22
6H08-1-1U	Ø 10 x 22mm	56	22
6H01-1-1U	Ø 10 x 30mm	52.5	30
6H20-1-1U	M8 x 15mm	59	15
6H02-1-1U	M10 x 15mm	59	15
6H04-1-1U	38 x 38mm Plate	61	-
6H51-1-1U	42 x 42mm Plate	61	-

### BLACK - SOFT TYRE



### NO.

6H00-64	-----	52.5	-
6H03-64	Ø 11 x 22mm	56	22
6H08-64	Ø 10 x 22mm	56	22
6H01-64	Ø 10 x 30mm	52.5	30
6H20-64	M8 x 15mm	59	15
6H02-64	M10 x 15mm	59	15
6H04-64	38 x 38mm Plate	61	-
6H51-64	42 x 42mm Plate	61	-

### RAL 9006 - HARD WHEEL



### NO.

6H00-64-64-T1U	-----	52.5	-
6H03-64-64-T1U	Ø 11 x 22mm	56	22
6H08-64-64-T1U	Ø 10 x 22mm	56	22
6H01-64-64-T1U	Ø 10 x 30mm	52.5	30
6H20-64-64-T1U	M8 x 15mm	59	15
6H02-64-64-T1U	M10 x 15mm	59	15
6H04-64-64-T1U	38 x 38mm Plate	61	-
6H51-64-64-T1U	42 x 42mm Plate	61	-

### RAL 9006 - SOFT TYRE



Ø11 x 22mm

Ø10 x 22mm

Ø10 x 30mm

M8 x 15mm

M10 x 15mm

38 x 38mm Plate

42 x 42mm Plate

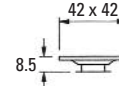
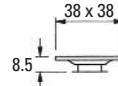
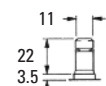

# GRX5018 CONDUCTIVE CASTOR

## SPECIFICATION

### CASTOR TYPE

Swivel  
Conductive <100,000Ω

### MATERIALS

Castor PA  
Soft Tyre PUR

### STANDARD COLOURS

Black  
Grey

### STANDARDS

EN 12528  
EN 12529

## TECHNISCHE DATEN

### ROLLEN TYP

Lenkrolle  
Leitfähig <100,000Ω

### MATERIAL

Rolle PA  
Weiche Lauffläche PUR

### STANDARDFARBEN

Schwarz  
Grau

### NORMEN

EN 12528  
EN 12529

## SPECIFICATION

### TYPE DE ROULETTE

Pivotante  
Antistatique <100,000Ω

### MATIERES

Roulette PA  
Bandes Souples PUR

### COLORIS STANDARD

Noir  
Gris

### NORMES

EN 12528  
EN 12529

## ESPECIFICACION

### TIPO DE RUEDA

Giratoria  
Antiestática <100,000Ω

### MATERIALES

Rueda Nilón  
Rodadura Blanda Poliuretano

### COLORES ESTANDAR

Negro  
Gris

### NORMAS

EN 12528  
EN 12529



50



52.5



18



7



53



19



47.5



40kg



52.5



-

### NO.

6G00-1-1-T2UC  
6G03-1-1-T2UC  
6G08-1-1-T2UC  
6G01-1-1-T2UC  
6G20-1-1-T2UC  
6G02-1-1-T2UC  
6G04-1-1-T2UC  
6G51-1-1-T2UC

-----  
Ø 11 x 22mm  
Ø 10 x 22mm  
Ø 10 x 30mm  
M8 x 15mm  
M10 x 15mm  
38 x 38mm Plate  
42 x 42mm Plate

56  
56  
52.5  
59  
59  
61  
61

22  
22  
30  
15  
15  
-  
-

### BLACK



### NO.

6G00-2525-T2UC  
6G03-2525-T2UC  
6G08-2525-T2UC  
6G01-2525-T2UC  
6G20-2525-T2UC  
6G02-2525-T2UC  
6G04-2525-T2UC  
6G51-2525-T2UC

-----  
Ø 11 x 22mm  
Ø 10 x 22mm  
Ø 10 x 30mm  
M8 x 15mm  
M10 x 15mm  
38 x 38mm Plate  
42 x 42mm Plate

52.5  
56  
56  
52.5  
59  
59  
61  
61

-  
22  
22  
30  
15  
15  
-  
-

### GREY



Ø 11 x 22mm



Ø 10 x 22mm



Ø 10 x 30mm



M8 x 15mm



M10 x 15mm



38 x 38mm Plate



42 x 42mm Plate



# GRX5018FB CONDUCTIVE WHEEL BRAKE CASTOR

## SPECIFICATION

### CASTOR TYPE

Wheel Brake  
Conductive <100,000Ω

### MATERIALS

Castor PA  
Soft Tyre PUR

### STANDARD COLOURS

Black  
Grey

### STANDARDS

EN 12528

## TECHNISCHE DATEN

### ROLLEN TYP

Radfeststeller  
Leitfähig <100,000Ω

### MATERIAL

Rolle PA  
Weiche Lauffläche PUR

### STANDARDFARBEN

Schwarz  
Grau

### NORMEN

EN 12528

## SPECIFICATION

### TYPE DE ROULETTE

Blocage de Roue  
Antistatique <100,000Ω

### MATIERES

Roulette PA  
Bandes Souples PUR

### COLORIS STANDARD

Noir  
Gris

### NORMES

EN 12528

## ESPECIFICACION

### TIPO DE RUEDA

Freno de Rueda  
Antiestática <100,000Ω

### MATERIALES

Rueda Nilón  
Rodadura Blanda Poliuretano

### COLORES ESTANDAR

Negro  
Gris

### NORMAS

EN 12528



50



52.5



18



7



53

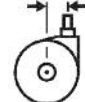

19



65



35kg



### NO.

6H00-1-1-T2UC  
6H03-1-1-T2UC  
6H08-1-1-T2UC  
6H01-1-1-T2UC  
6H20-1-1-T2UC  
6H02-1-1-T2UC  
6H04-1-1-T2UC  
6H51-1-1-T2UC

-----  
Ø 11 x 22mm  
Ø 10 x 22mm  
Ø 10 x 30mm  
M8 x 15mm  
M10 x 15mm  
38 x 38mm Plate  
42 x 42mm Plate

52.5  
56  
56  
52.5  
59  
59  
61  
61

-  
22  
22  
30  
15  
15  
-  
-

### BLACK



### NO.

6H00-2525-T2UC  
6H03-2525-T2UC  
6H08-2525-T2UC  
6H01-2525-T2UC  
6H20-2525-T2UC  
6H02-2525-T2UC  
6H04-2525-T2UC  
6H51-2525-T2UC

-----  
Ø 11 x 22mm  
Ø 10 x 22mm  
Ø 10 x 30mm  
M8 x 15mm  
M10 x 15mm  
38 x 38mm Plate  
42 x 42mm Plate

52.5  
56  
56  
52.5  
59  
59  
61  
61

-  
22  
22  
30  
15  
15  
-  
-

### GREY



Ø11 x 22mm

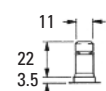

Ø10 x 22mm



Ø10 x 30mm



M8 x 15mm



M10 x 15mm



38 x 38mm Plate

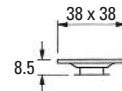

42 x 42mm Plate

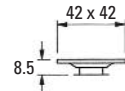



# GRX5018 CASTOR

## SPECIFICATION

### CASTOR TYPE

Swivel

### MATERIALS

Castor PA

Hard Wheel PA

Soft Tyre PUR

### STANDARD COLOURS

Black

Aluminium RAL 9006

### STANDARDS

EN 12529

## TECHNISCHE DATEN

### ROLLEN TYP

Lenkrolle

### MATERIAL

Rollen PA

Harte Räder PA

Weiche Lauffläche PUR

### STANDARDFARBEN

Schwarz

Aluminium RAL 9006

### NORMEN

EN 12529

## SPECIFICATION

### TYPE DE ROULETTE

Pivotante

### MATIERES

Roulette PA

Roue Dure PA

Bandes Souples PUR

### COLORIS STANDARD

Noir

Alu RAL 9006

### NORMES

EN 12529

## ESPECIFICACION

### TIPO DE RUEDA

Giratoria

### MATERIALES

Rueda Nilón

Rodadura Dura Nilón

Rodadura Blanda Poliuretano

### COLORES ESTANDAR

Negro

Plateado RAL 9006

### NORMAS

EN 12529



50



52.5



18



7

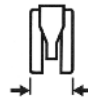

53



19



47.5



40kg



-----  
 Ø 11 x 22mm  
 Ø 10 x 22mm  
 Ø 10 x 30mm



52.5  
56  
56  
52.5



-  
22  
22  
30

### NO.

6G00-1  
6G03-1  
6G08-1  
6G01-1

### BLACK - HARD WHEEL



### NO.

6G00-1-1U  
6G03-1-1U  
6G08-1-1U  
6G01-1-1U

-----  
 Ø 11 x 22mm  
 Ø 10 x 22mm  
 Ø 10 x 30mm

52.5  
56  
56  
52.5

-  
22  
22  
30

### BLACK - SOFT TYRE

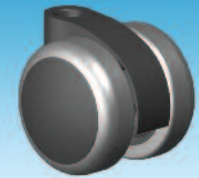

### NO.

6G00-64  
6G03-64  
6G08-64  
6G01-64

-----  
 Ø 11 x 22mm  
 Ø 10 x 22mm  
 Ø 10 x 30mm

52.5  
56  
56  
52.5

-  
22  
22  
30

### RAL 9006 - HARD WHEEL

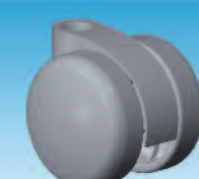

### NO.

6G00-64-64-T1U  
6G03-64-64-T1U  
6G08-64-64-T1U  
6G01-64-64-T1U

-----  
 Ø 11 x 22mm  
 Ø 10 x 22mm  
 Ø 10 x 30mm

52.5  
56  
56  
52.5

-  
22  
22  
30

### RAL 9006 - SOFT TYRE

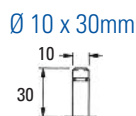
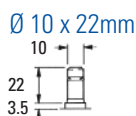
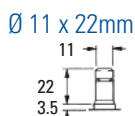
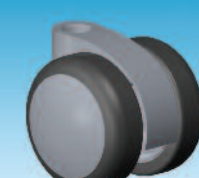

**SPECIFICATION**

**CASTOR TYPE**

Brake Unloaded

**MATERIALS**

Castor PA

Hard Wheel PA

Soft Tyre PUR

**STANDARD COLOURS**

Black

Aluminium RAL 9006

**STANDARDS**

EN 12529 TYPE U

**TECHNISCHE DATEN**

**ROLLEN TYP**

Lastabhängig Gebremst

**MATERIAL**

Rollen PA

Harte Räder PA

Weiche Lauffläche PUR

**STANDARDFARBEN**

Schwarz

Aluminium RAL 9006

**NORMEN**

EN 12529 TYP U

**SPECIFICATION**

**TYPE DE ROULETTE**

Autofreiné

**MATIERES**

Roulette PA

Roue Dure PA

Bandes Souples PUR

**COLORIS STANDARD**

Noir

Alu RAL 9006

**NORMES**

EN 12529 TYPE U

**ESPECIFICACION**

**TIPO DE RUEDA**

Autofrenado

**MATERIALES**

Rueda Nilón

Rodadura Dura Nilón

Rodadura Blanda Poliuretano

**COLORES ESTANDAR**

Negro

Plateado RAL 9006

**NORMAS**

EN 12529 TIPO U



50



53.5



18



7



53

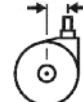

19



47.5



40kg



53.5



22

**BLACK - HARD WHEEL**

**NO.**

4E00-1

4E03-1

4E08-1

4E01-1

Ø 11 x 22mm

Ø 10 x 22mm

Ø 10 x 30mm

57

57

53.5

22

22

30



**BLACK - SOFT TYRE**

**NO.**

4E00-1-1U

4E03-1-1U

4E08-1-1U

4E01-1-1U

Ø 11 x 22mm

Ø 10 x 22mm

Ø 10 x 30mm

53.5

57

57

53.5

-

22

22

30



**RAL 9006 - HARD WHEEL**

**NO.**

4E00-64

4E03-64

4E08-64

4E01-64

Ø 11 x 22mm

Ø 10 x 22mm

Ø 10 x 30mm

53.5

57

57

53.5

-

22

22

30



**RAL 9006 - SOFT TYRE**

**NO.**

4E00-64-64-T1U

4E03-64-64-T1U

4E08-64-64-T1U

4E01-64-64-T1U

Ø 11 x 22mm

Ø 10 x 22mm

Ø 10 x 30mm

53.5

57

57

53.5

-

22

22

30



Ø 11 x 22mm



Ø 10 x 22mm



Ø 10 x 30mm



# GRX5016 GLIDE

## SPECIFICATION

### MATERIALS

Stem Steel BZP  
Glide PA

### STANDARD COLOURS

Black

## TECHNISCHE DATEN

### MATERIAL

Stift Stahl Verzinkt  
Gleiter PA

### STANDARDFARBEN

Schwarz

## SPECIFICATION

### MATIERES

Tige Acier, plaqué de zinc  
Patin PA

### COLORIS STANDARD

Noir

## ESPECIFICACION

### MATERIALES

Vástago Acero, chapado de zinc  
Pata Deslizante Nilón

### COLORES ESTANDAR

Negro



53.5



16



25

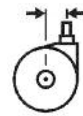

7.5



35



## GRX5016 GLIDE

### NO.

7100-1	-----	53.5	---	50
7103-1	Ø11 x 22mm	57	22	50
7108-1	Ø10 x 22mm	57	22	50
7120-1	M8 x 15mm	60	15	50
7102-1	M10 x 15mm	60	15	50



# GRX6518 GLIDE

## SPECIFICATION

### MATERIALS

Stem Steel BZP  
Glide PA

### STANDARD COLOURS

Black

## TECHNISCHE DATEN

### MATERIAL

Stift Stahl Verzinkt  
Gleiter PA

### STANDARDFARBEN

Schwarz

## SPECIFICATION

### MATIERES

Tige Acier, plaqué de zinc  
Patin PA

### COLORIS STANDARD

Noir

## ESPECIFICACION

### MATERIALES

Vástago Acero, chapado de zinc  
Pata Deslizante Nilón

### COLORES ESTANDAR

Negro



68



18

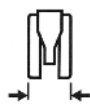

32

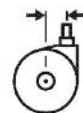

22.5



56



## GRX6518 GLIDE

### NO.

4C00-1	-----	68	---	50
4C03-1	Ø11 x 22mm	71.5	22	50
4C08-1	Ø10 x 22mm	71.5	22	50
4C20-1	M8 x 15mm	74.5	15	50
4C02-1	M10 x 15mm	74.5	15	50



Registered Design



## SPECIFICATION

### MATERIALS

Steel BZP

## TECHNISCHE DATEN

### MATERIAL

Stahl Verzinkt

## SPECIFICATION

### MATIERES

Acier, plaqué de zinc

## ESPECIFICACION

### MATERIALES

Acero chapado de zinc

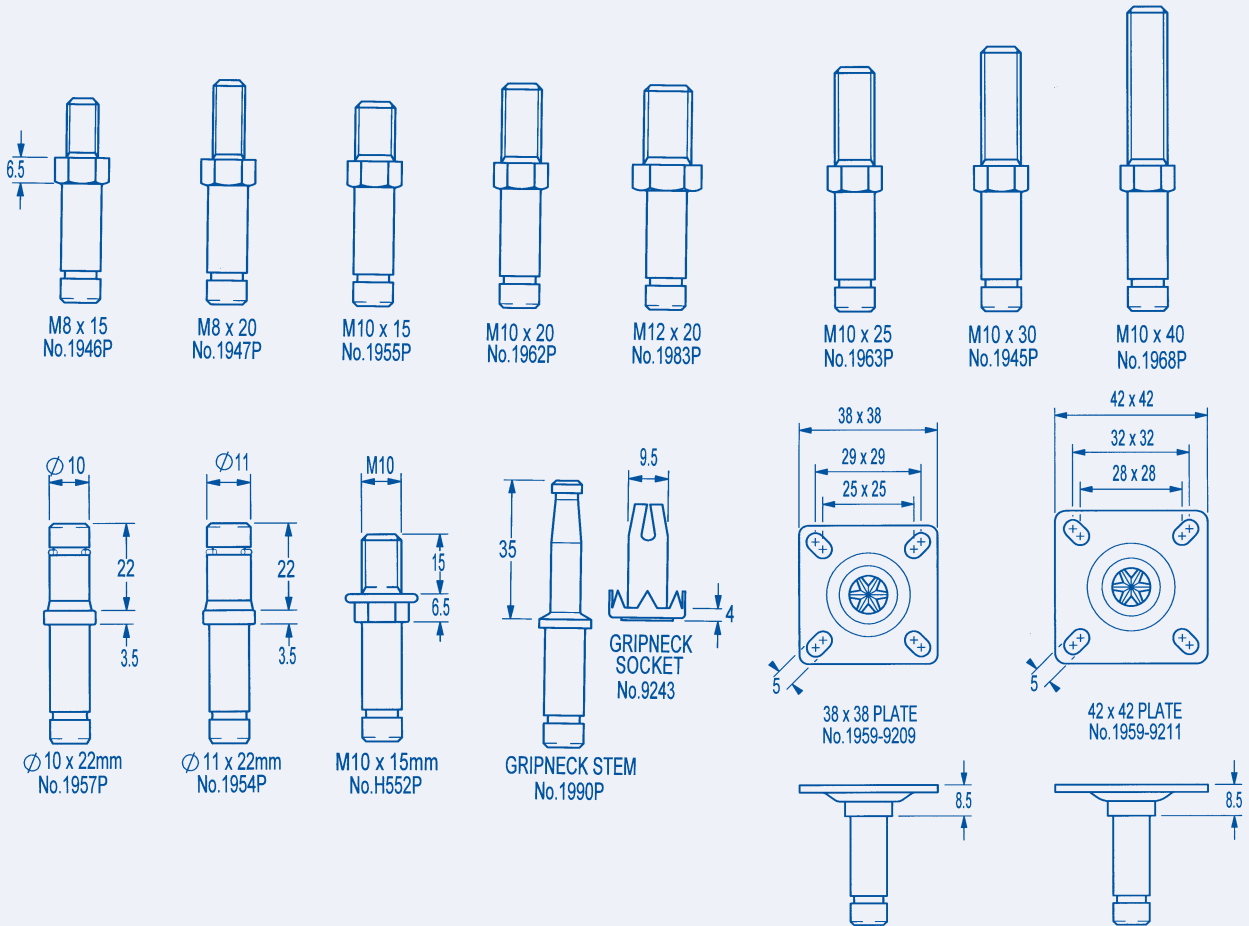

## INTRODUCTION

The GRX65 range of castors has a nominal wheel diameter of 65mm, and a load capacity of 50 kgs per castor. The GRX65 is available as Castor Types:- A) freewheel swivel or B) brake unloaded conforming to EN12529 section 4.2.4 Type U.

The GRX6518 and GRX6528 are available with wheel brake and are called GRX6518FB and GRX6528FB. All castors are offered with either hard wheels or soft tyres. Hard wheels are recommended for soft floorings and soft tyres are recommended for hard floors, further guidance is given in EN 12528 and EN12529.

## EINFÜHRUNG

Die GRX65 Rollen haben einen Raddurchmesser von 65mm und eine Lastfähigkeit von 50kg pro Rolle. Standardmäßig ist diese Rolle entweder A) freilaufend und B) unbelastet gebremst nach Normen 12529 4.2.4 Typ U erhältlich. Rolle GRX6518 und GRX6528 sind auch mit Feststeller oder als GRX6518FB und GRX6528FB zu haben. Wir bieten diese Rollen mit harter oder weicher Lauffläche. Für weiche Böden eignet sich die harte Lauffläche, für harte Böden empfehlen wir die weiche, mehr Infos dazu in den Normen EN 12528 und EN 12529.

## INTRODUCTION

Les roulettes de la gamme GRX65 ont des roues de diamètre 65mm, et supportent une charge de 50 kgs par roulette. La GRX65 est disponible en modèle:- A) non freiné ou B) autofreiné conforme à la norme EN12529 section 4.2.4 Type U. La GRX6518 et la GRX6528 sont disponibles avec frein à pied – ces modèles s'appellent GRX6518FB et GRX6528FB.

Toutes les roulettes sont disponibles avec roues dures ou bandes souples. Les roues dures sont recommandées pour sols souples et les bandes souples sont recommandées pour sols durs. Se référer aux normes EN 12528 et EN12529.

## INTRODUCCION

Las ruedas de la gama GRX65 tienen ruedas de diámetro 65mm, y una capacidad de carga de 50 kgs por rueda. La GRX65 está disponible como modelo:- A) sin freno o B) con freno automática conforme a la norma EN12529 sección 4.2.4 tipo U. La GRX6518 y la GRX6528 están disponibles con freno a pie – estos modelos se llaman GRX6518FB y GRX6528FB.

Todas ruedas están disponibles con rodadura blanda o con rodadura dura. La rodadura dura es recomendada para suelos blandos y la rodadura blanda es recomendada para suelos duros. Referirse a las normas EN 12528 y EN12529.

## FEATURES

- GRX Design
- Interchangeable stems with GR50 range (except GRX65HT & GRX65HTBU)
- Patented dust shield
- Twin retaining groove axle
- Polyamide structure
- Polyamide soft tyre hub
- Polyurethane soft tyre

## EIGENSCHAFTEN:

- GRX Design
- Viele Befestigungsmöglichkeiten (außer Rollen GRX65HT & GRX65HTBU)
- Patentierter Achsschutz
- Verdoppelte Haftungsringe an der Achse
- Polyamid Struktur
- Polyamid Rad
- Polyurethan weiche Lauffläche

## CARACTERISTIQUES

- Design GRX
- Les fixations pour les gammes GRX65 et GRX50 sont interchangeables (sauf celles des modèles GRX65HT & GRX65HTBU)
- Capot de protection de l'axe contre la poussière - breveté
- Double rainure sur l'axe pour une fixation solide des roues
- Capot en polyamide
- Roues en polyamide
- Bandes souples en polyuréthane

## ELEMENTOS

- Diseño GRX
- Las fijaciones son intercambiables con ellas de la gama GRX50 (excepto ellas de las ruedas GRX65HT & GRX65HTBU)
- Protector del eje contra el polvo (patentado)
- Ranura doble en el eje para tener las ruedas
- Producto de PA (Nilón)
- Ruedas de PA (Nilón)
- Rodadura blanda de poliuretano



## APPLICATIONS

- Office furniture
- Office chairs
- Domestic furniture
- TV / video / audio stands
- Shop and display
- Point of Sale stands
- Printer stands
- Home care furniture

## ANWENDUNGEN:

- Büromöbel
- Bürostühle
- Wohnmöbel
- TV/Video/Hi-Fi Schränke
- Ladenbau
- Displayständer
- Druckerständer
- Pflegemöbel

## APPLICATIONS

- Meubles de bureau
- Chaises de bureau
- Meubles domestiques
- Meubles de TV / video / hi-fi
- Aménagement de magasins
- Etalages pour PDV
- Supports pour imprimants
- Mobilier HAD-MAD

## USOS

- Mueble de oficina
- Sillas de oficina
- Muebles domesticos
- Muebles para TV / video / equipo de alta fidelidad
- Equipo de tiendas
- Estantes para punto de venta
- Estantes para impresoras
- Mobiliario para asistencia domestica

## FITTINGS

Guy-Raymond manufactures a wide range of standard fittings these are shown on the opposite page. In addition Guy-Raymond can design and develop special fittings to customer requirements. Castors can be supplied assembled with certain popular stems and these are shown on pages 20 to 43.

## BEFESTIGUNGEN:

Guy-Raymond bietet viele verschiedene Befestigungsmöglichkeiten, welche Sie auf der nächsten Seite finden. Zusätzlich haben wir die Möglichkeit mit Ihnen eine Sonderbefestigung zu entwickeln. Die Rollen können in montiertem Zustand geliefert werden mit den populären Stiften auf Seiten 20 bis 43.

## FIXATIONS

Guy-Raymond fabrique une gamme étendue de fixations standard - celles-ci sont présentées sur la page en face. De plus Guy-Raymond peut dessiner et développer des fixations spéciales pour correspondre aux besoins des clients. Les fixations courantes peuvent être fournies montées dans les roulettes et ces possibilités sont présentées sur les pages 20 à 43.

## FIJACIONES

Guy-Raymond fabrica una gran gama de fijaciones – estas son presentadas en la página enfrente. Además Guy-Raymond puede diseñar y desarrollar fijaciones especiales según las necesidades de los clientes. Ruedas pueden ser suministradas montadas con las fijaciones más populares y estas posibilidades son presentadas en las páginas 20 a 43.

## SPECIFICATION

### MATERIALS

Steel BZP

## TECHNISCHE DATEN

### MATERIAL

Stahl Verzinkt

## SPECIFICATION

### MATIERES

Acier, plaqué de zinc

## ESPECIFICACION

### MATERIALES

Acero chapado de zinc

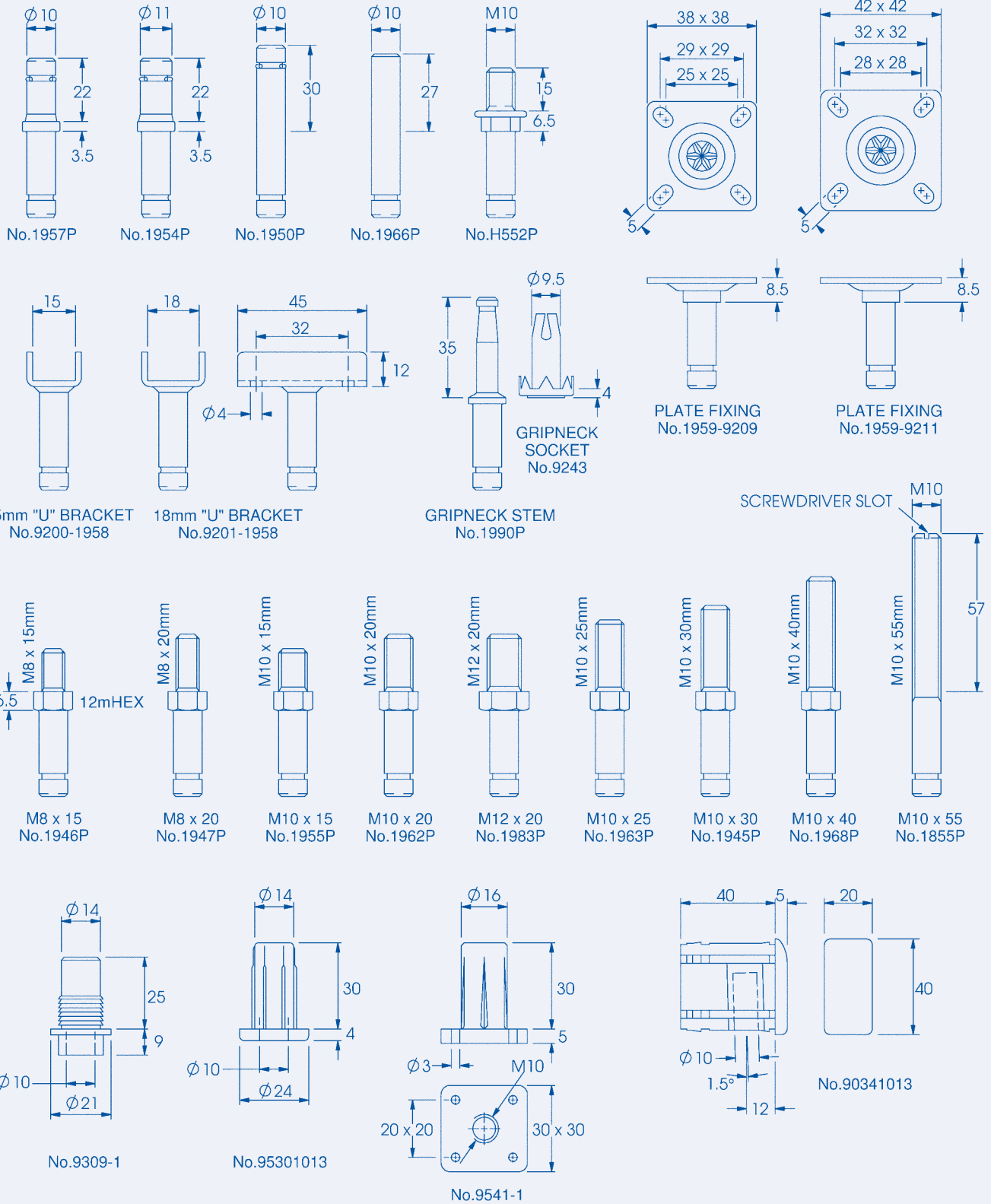

Note: longer stems required for GRX65HT and GRX65HTBU

Hinweis: GRX65HT und GRX65HTBU benötigen längere Stifte

Note: des tiges plus longues sont nécessaires pour les modèles GRX65HT et GRX65HTBU

Nota: Los modelos GRX65HT y GRX65HTBU requieren fijaciones más largas

# GRX6518 CASTOR

## SPECIFICATION

### CASTOR TYPE

Swivel

### MATERIALS

Castor PA  
Hard Wheel PA  
Soft Tyre PUR

### STANDARD COLOURS

Black  
Aluminium RAL 9006

### STANDARDS

EN 12528

## TECHNISCHE DATEN

### ROLLEN TYP

Lenkrolle

### MATERIAL

Rollen PA  
Harte Räder PA  
Weiche Lauffläche PUR

### STANDARDFARBEN

Schwarz  
Aluminium RAL 9006

### NORMEN

EN 12528

## SPECIFICATION

### TYPE DE ROULETTE

Pivotante

### MATIERES

Roulette PA  
Roue Dure PA  
Bandes Souples PUR

### COLORIS STANDARD

Noir  
Alu RAL 9006

### NORMES

EN 12528

## ESPECIFICACION

### TIPO DE RUEDA

Giratoria

### MATERIALES

Rueda Nilón  
Rodadura Dura Nilón  
Rodadura Blanda Poliuretano

### COLORES ESTANDAR

Negro  
Plateado RAL 9006

### NORMAS

EN 12528



65



66



18



7

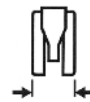

53

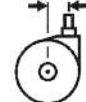

22.5



58



50kg



66



22

### NO.

6000-1	-----	66	-
6003-1	Ø 11 x 22mm	69.5	22
6008-1	Ø 10 x 22mm	69.5	22
6001-1	Ø 10 x 30mm	66	30
6002-1	M10 x 15mm	72.5	15
6036-1	M12 x 20mm	72.5	20
6004-1	38 x 38mm Plate	74.5	-
6051-1	42 x 42mm Plate	74.5	-

### BLACK - HARD WHEEL



### NO.

6000-1-1U	-----	66	-
6003-1-1U	Ø 11 x 22mm	69.5	22
6008-1-1U	Ø 10 x 22mm	69.5	22
6001-1-1U	Ø 10 x 30mm	66	30
6002-1-1U	M10 x 15mm	72.5	15
6036-1-1U	M12 x 20mm	72.5	20
6004-1-1U	38 x 38mm Plate	74.5	-
6051-1-1U	42 x 42mm Plate	74.5	-

### BLACK - SOFT TYRE



### NO.

6000-64	-----	66	-
6003-64	Ø 11 x 22mm	69.5	22
6008-64	Ø 10 x 22mm	69.5	22
6001-64	Ø 10 x 30mm	66	30
6002-64	M10 x 15mm	72.5	15
6036-64	M12 x 20mm	72.5	20
6004-64	38 x 38mm Plate	74.5	-
6051-64	42 x 42mm Plate	74.5	-

### RAL 9006 - HARD WHEEL



### NO.

6000-64-64-T1U	-----	66	-
6003-64-64-T1U	Ø 11 x 22mm	69.5	22
6008-64-64-T1U	Ø 10 x 22mm	69.5	22
6001-64-64-T1U	Ø 10 x 30mm	66	30
6002-64-64-T1U	M10 x 15mm	72.5	15
6036-64-64-T1U	M12 x 20mm	72.5	20
6004-64-64-T1U	38 x 38mm Plate	74.5	-
6051-64-64-T1U	42 x 42mm Plate	74.5	-

### RAL 9006 - SOFT TYRE



Ø 11 x 22mm



Ø 10 x 22mm



Ø 10 x 30mm



M10 x 15mm



M12 x 20mm



38 x 38mm Plate

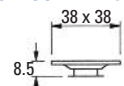

42 x 42mm Plate

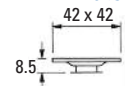



## SPECIFICATION

### CASTOR TYPE

Wheel Brake

### MATERIALS

Castor PA

Hard Wheel PA

Soft Tyre PUR

### STANDARD COLOURS

Black

Aluminium RAL 9006

### STANDARDS

EN 12528

## TECHNISCHE DATEN

### ROLLEN TYP

Radfeststeller

### MATERIAL

Rollen PA

Harte Räder PA

Weiche Lauffläche PUR

### STANDARDFARBEN

Schwarz

Aluminium RAL 9006

### NORMEN

EN 12528

## SPECIFICATION

### TYPE DE ROULETTE

Blocage de Roue

### MATIERES

Roulette PA

Roue Dure PA

Bandes Souples PUR

### COLORIS STANDARD

Noir

Alu RAL 9006

### NORMES

EN 12528

## ESPECIFICACION

### TIPO DE RUEDA

Freno de Rueda

### MATERIALES

Rueda Nilón

Rodadura Dura Nilon

Rodadura Blanda Poliuretano

### COLORES ESTANDAR

Negro

Plateado RAL 9006

### NORMAS

EN 12528



65



66



18



7



53

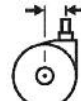

22.5



76



50kg



### NO.

5100-1

-----

66

-

5103-1

Ø 11 x 22mm

69.5

22

5108-1

Ø 10 x 22mm

69.5

22

5101-1

Ø 10 x 30mm

66

30

5102-1

M10 x 15mm

72.5

15

5136-1

M12 x 20mm

72.5

20

5104-1

38 x 38mm Plate

74.5

-

5151-1

42 x 42mm Plate

74.5

-

### BLACK - HARD WHEEL



### NO.

5100-1-1U

-----

66

-

5103-1-1U

Ø 11 x 22mm

69.5

22

5108-1-1U

Ø 10 x 22mm

69.5

22

5101-1-1U

Ø 10 x 30mm

66

30

5102-1-1U

M10 x 15mm

72.5

15

5136-1-1U

M12 x 20mm

72.5

20

5104-1-1U

38 x 38mm Plate

74.5

-

5151-1-1U

42 x 42mm Plate

74.5

-

### BLACK - SOFT TYRE



### NO.

5100-64

-----

66

-

5103-64

Ø 11 x 22mm

69.5

22

5108-64

Ø 10 x 22mm

69.5

22

5101-64

Ø 10 x 30mm

66

30

5102-64

M10 x 15mm

72.5

15

5136-64

M12 x 20mm

72.5

20

5104-64

38 x 38mm Plate

74.5

-

5151-64

42 x 42mm Plate

74.5

-

### RAL 9006 - HARD WHEEL



### NO.

5100-64-64-T1U

-----

66

-

5103-64-64-T1U

Ø 11 x 22mm

69.5

22

5108-64-64-T1U

Ø 10 x 22mm

69.5

22

5101-64-64-T1U

Ø 10 x 30mm

66

30

5102-64-64-T1U

M10 x 15mm

72.5

15

5136-64-64-T1U

M12 x 20mm

72.5

20

5104-64-64-T1U

38 x 38mm Plate

74.5

-

5151-64-64-T1U

42 x 42mm Plate

74.5

-

### RAL 9006 - SOFT TYRE



Ø 11 x 22mm



Ø 10 x 22mm



Ø 10 x 30mm



M10 x 15mm



M12 x 20mm



38 x 38mm Plate



42 X 42mm Plate



# GRX6518 CONDUCTIVE CASTOR

## SPECIFICATION

### CASTOR TYPE

Swivel  
Conductive <100,000Ω

### MATERIALS

Castor PA  
Soft Tyre PUR

### STANDARD COLOURS

Black  
Grey

### STANDARDS

EN 12528

## TECHNISCHE DATEN

### ROLLEN TYP

Lenkrolle  
Leitfähig <100,000Ω

### MATERIAL

Rolle PA  
Weiche Lauffläche PUR

### STANDARDFARBEN

Schwarz  
Grau

### NORMEN

EN 12528

## SPECIFICATION

### TYPE DE ROULETTE

Pivotante  
Antistatique <100,000Ω

### MATIERES

Roulette PA  
Bandes Souples PUR

### COLORIS STANDARD

Noir  
Gris

### NORMES

EN 12528

## ESPECIFICACION

### TIPO DE RUEDA

Giratorio  
Antiestática <100,000Ω

### MATERIALES

Rueda Nilón  
Rodadura Blanda Poliuretano

### COLORES ESTANDAR

Negro  
Gris

### NORMAS

EN 12528



65



66



18



7



53

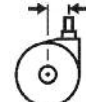

22.5



58



50kg



### NO.

6000-1-1-T2UC  
6003-1-1-T2UC  
6008-1-1-T2UC  
6001-1-1-T2UC  
6002-1-1-T2UC  
6036-1-1-T2UC  
6004-1-1-T2UC  
6051-1-1-T2UC

-----  
Ø 11 x 22mm  
Ø 10 x 22mm  
Ø 10 x 30mm  
M10 x 15mm  
M12 x 20mm  
38 x 38mm Plate  
42 x 42mm Plate

66  
69.5  
69.5  
66  
72.5  
72.5  
74.5  
74.5

-  
22  
22  
30  
15  
20  
-  
-

### BLACK



### NO.

6000-2525-T2UC  
6003-2525-T2UC  
6008-2525-T2UC  
6001-2525-T2UC  
6002-2535-T2UC  
6036-2525-T2UC  
6004-2525-T2UC  
6051-2525-T2UC

-----  
Ø 11 x 22mm  
Ø 10 x 22mm  
Ø 10 x 30mm  
M10 x 15mm  
M12 x 20mm  
38 x 38mm Plate  
42 x 42mm Plate

66  
69.5  
69.5  
66  
72.5  
72.5  
74.5  
74.5

-  
22  
22  
30  
15  
20  
-  
-

### GREY



Ø 11 x 22mm



Ø 10 x 22mm

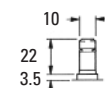

Ø 10 x 30mm

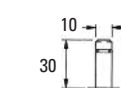

M10 x 15mm

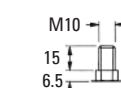

M12 x 20mm



38 x 38mm Plate

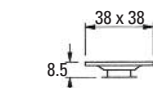

42 x 42mm Plate

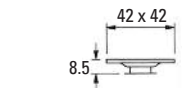

## SPECIFICATION

### CASTOR TYPE

Wheel Brake  
Conductive <100,000Ω

### MATERIALS

Castor PA  
Soft Tyre PUR

### STANDARD COLOURS

Black  
Grey

### STANDARDS

EN 12528

## TECHNISCHE DATEN

### ROLLEN TYP

Radfeststeller  
Leitfähig <100,000Ω

### MATERIAL

Rolle PA  
Weiche Lauffläche PUR

### STANDARDFARBEN

Schwarz  
Grau

### NORMEN

EN 12528

## SPECIFICATION

### TYPE DE ROULETTE

Blocage de Roue  
Antistatique <100,000Ω

### MATIERES

Roulette PA  
Bandes Souples PUR

### COLORIS STANDARD

Noir  
Gris

### NORMES

EN 12528

## ESPECIFICACION

### TIPO DE RUEDA

Freno de Rueda  
Antiestática <100,000Ω

### MATERIALES

Rueda Nylon  
Rodadura Blanda Poliuretano

### COLORES ESTANDAR

Negro  
Gris

### NORMAS

EN 12528



65



66



18



7

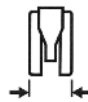

53

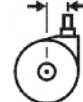

22.5



76



50kg



### NO.

5100-1-1-T2UC  
5103-1-1-T2UC  
5108-1-1-T2UC  
5101-1-1-T2UC  
5102-1-1-T2UC  
5136-1-1-T2UC  
5104-1-1-T2UC  
5151-1-1-T2UC

-----  
Ø 11 x 22mm  
Ø 10 x 22mm  
Ø 10 x 30mm  
M10 x 15mm  
M12 x 20mm  
38 x 38mm Plate  
42 x 42mm Plate

66  
69.5  
69.5  
66  
72.5  
72.5  
74.5  
74.5

-  
22  
22  
30  
15  
20  
-  
-

### BLACK



### NO.

5100-2525-T2UC  
5103-2525-T2UC  
5108-2525-T2UC  
5101-2525-T2UC  
5102-2525-T2UC  
5136-2525-T2UC  
5104-2525-T2UC  
5151-2525-T2UC

-----  
Ø 11 x 22mm  
Ø 10 x 22mm  
Ø 10 x 30mm  
M10 x 15mm  
M12 x 20mm  
38 x 38mm Plate  
42 x 42mm Plate

66  
69.5  
69.5  
66  
72.5  
72.5  
74.5  
74.5

-  
22  
22  
30  
15  
20  
-  
-

### GREY



Ø 11 x 22mm



Ø 10 x 22mm



Ø 10 x 30mm



M10 x 15mm



M12 x 20mm



38 x 38mm Plate

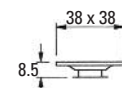

42 x 42mm Plate

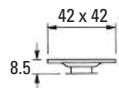

# GRX6528 CASTOR

## SPECIFICATION

### CASTOR TYPE

Swivel

### MATERIALS

Castor PA  
Hard Wheel PA  
Soft Tyre PUR

### STANDARD COLOURS

Black  
Aluminium RAL 9006

### STANDARDS

EN 12528

## TECHNISCHE DATEN

### ROLLEN TYP

Lenkrolle

### MATERIAL

Rollen PA  
Harte Räder PA  
Weiche Lauffläche PUR

### STANDARDFARBEN

Schwarz  
Aluminium RAL 9006

### NORMEN

EN 12528

## SPECIFICATION

### TYPE DE ROULETTE

Pivotante

### MATIERES

Roulette PA  
Roue Dure PA  
Bandes Souples PUR

### COLORIS STANDARD

Noir  
Alu RAL 9006

### NORMES

EN 12528

## ESPECIFICACION

### TIPO DE RUEDA

Giratoria

### MATERIALES

Rueda Nilón  
Rodadura Dura Nilón  
Rodadura Blanda Poliuretano

### COLORES ESTANDAR

Negro  
Plateado RAL 9006

### NORMAS

EN 12528



65



69



28



7

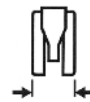

53

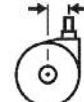

22.5



58



50kg



### NO.

NO.		69	-
3900-1	-----	69	-
3903-1	Ø 11 x 22mm	71	22
3908-1	Ø 10 x 22mm	71	22
3901-1	Ø 10 x 30mm	69	28.5
3902-1	M10 x 15mm	73.5	15
3936-1	M12 x 20mm	73.5	20
3904-1	38 x 38mm Plate	75.5	-
3951-1	42 x 42mm Plate	75.5	-

### BLACK - HARD WHEEL



### NO.

NO.		69	-
3900-1-1U	-----	69	-
3903-1-1U	Ø 11 x 22mm	71	22
3908-1-1U	Ø 10 x 22mm	71	22
3901-1-1U	Ø 10 x 30mm	69	28.5
3902-1-1U	M10 x 15mm	73.5	15
3936-1-1U	M12 x 20mm	73.5	20
3904-1-1U	38 x 38mm Plate	75.5	-
3951-1-1U	42 x 42mm Plate	75.5	-

### BLACK - SOFT TYRE



### NO.

NO.		69	-
3900-64	-----	69	-
3903-64	Ø 11 x 22mm	71	22
3908-64	Ø 10 x 22mm	71	22
3901-64	Ø 10 x 30mm	69	28.5
3902-64	M10 x 15mm	73.5	15
3936-64	M12 x 20mm	73.5	20
3904-64	38 x 38mm Plate	75.5	-
3951-64	42 x 42mm Plate	75.5	-

### RAL 9006 - HARD WHEEL



### NO.

NO.		69	-
3900-64-64-T1U	-----	69	-
3903-64-64-T1U	Ø 11 X 22mm	71	22
3908-64-64-T1U	Ø 10 X 22mm	71	22
3901-64-64-T1U	Ø 10 X 30mm	69	28.5
3902-64-64-T1U	M10 X 15mm	73.5	15
3936-64-64-T1U	M12 X 20mm	73.5	20
3904-64-64-T1U	38 X 38mm Plate	75.5	-
3951-64-64-T1U	42 X 42mm Plate	75.5	-

### RAL 9006 - SOFT TYRE



Ø 11 x 22mm

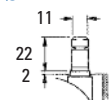

Ø 10 x 22mm

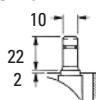

Ø 10 x 30mm

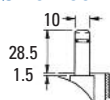

M10 x 15mm

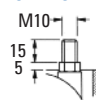

M12 x 20mm

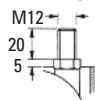

38 x 38mm Plate

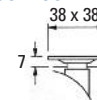

42 x 42mm Plate

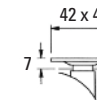

## SPECIFICATION

### CASTOR TYPE

Wheel Brake

### MATERIALS

Castor PA

Hard Wheel PA

Soft Tyre PUR

### STANDARD COLOURS

Black

Aluminium RAL 9006

### STANDARDS

EN 12528

## TECHNISCHE DATEN

### ROLLEN TYP

Radfeststeller

### MATERIAL

Rollen PA

Harte Räder PA

Weiche Lauffläche PUR

### STANDARDFARBEN

Schwarz

Aluminium RAL 9006

### NORMEN

EN 12528

## SPECIFICATION

### TYPE DE ROULETTE

Blocage de Roue

### MATIERES

Roulette PA

Roue Dure PA

Bandes Souples PUR

### COLORIS STANDARD

Noir

Alu RAL 9006

### NORMES

EN 12528

## ESPECIFICACION

### TIPO DE RUEDA

Freno de Rueda

### MATERIALES

Rueda Nilón

Rodadura Dura Nilon

Rodadura Blanda Poliuretano

### COLORES ESTANDAR

Negro

Plateado RAL 9006

### NORMAS

EN 12528



65



69



28



7



53



22.5



76



50kg



### NO.

3800-1

-----

69

-

3803-1

Ø 11 x 22mm

71

22

3808-1

Ø 10 x 22mm

71

22

3801-1

Ø 10 x 30mm

69

28.5

3802-1

M10 x 15mm

73.5

15

3836-1

M12 x 20mm

73.5

20

3804-1

38 x 38mm Plate

75.5

-

3851-1

42 x 42mm Plate

75.5

-

### BLACK - HARD WHEEL



### NO.

3800-1-1U

-----

69

-

3803-1-1U

Ø 11 x 22mm

71

22

3808-1-1U

Ø 10 x 22mm

71

22

3801-1-1U

Ø 10 x 30mm

69

28.5

3802-1-1U

M10 x 15mm

73.5

15

3836-1-1U

M12 x 20mm

73.5

20

3804-1-1U

38 x 38mm Plate

75.5

-

3851-1-1U

42 x 42mm Plate

75.5

-

### BLACK - SOFT TYRE



### NO.

3800-64

-----

69

-

3803-64

Ø 11 x 22mm

71

22

3808-64

Ø 10 x 22mm

71

22

3801-64

Ø 10 x 30mm

69

28.5

3802-64

M10 x 15mm

73.5

15

3836-64

M12 x 20mm

73.5

20

3804-64

38 x 38mm Plate

75.5

-

3851-64

42 x 42mm Plate

75.5

-

### RAL 9006 - HARD WHEEL



### NO.

3800-64-64-T1U

-----

69

-

3803-64-64-T1U

Ø 11 x 22mm

71

22

3808-64-64-T1U

Ø 10 x 22mm

71

22

3801-64-64-T1U

Ø 10 x 30mm

69

28.5

3802-64-64-T1U

M10 x 15mm

73.5

15

3836-64-64-T1U

M12 x 20mm

73.5

20

3804-64-64-T1U

38 x 38mm Plate

75.5

-

3851-64-64-T1U

42 x 42mm Plate

75.5

-

### RAL 9006 - SOFT TYRE



Ø 11 x 22mm

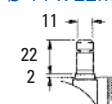

Ø 10 x 22mm

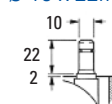

Ø 10 x 30mm

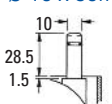

M10 x 15mm

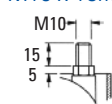

M12 x 20mm

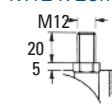

38 x 38mm Plate

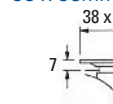

42 x 42mm Plate

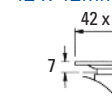



# GRX6528 CONDUCTIVE CASTOR

## SPECIFICATION

### CASTOR TYPE

Swivel  
Conductive <100,000Ω

### MATERIALS

Castor PA  
Soft Tyre PUR

### STANDARD COLOURS

Black  
Grey

### STANDARDS

EN 12528

## TECHNISCHE DATEN

### ROLLEN TYP

Lenkrolle  
Leitfähig <100,000Ω

### MATERIAL

Rolle PA  
Weiche Lauffläche PUR

### STANDARDFARBEN

Schwarz  
Grau

### NORMEN

EN 12528

## SPECIFICATION

### TYPE DE ROULETTE

Pivotante  
Antistatique <100,000Ω

### MATIERES

Roulette PA  
Bandes Souples PUR

### COLORIS STANDARD

Noir  
Gris

### NORMES

EN 12528

## ESPECIFICACION

### TIPO DE RUEDA

Giratorio  
Antiestática <100,000Ω

### MATERIALES

Rueda Nilón  
Rodadura Blanda Poliuretano

### COLORES ESTANDAR

Negro  
Gris

### NORMAS

EN 12530



65



69



28



7



53

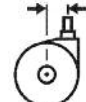

22.5



58



50kg



69



22

### NO.

3900-1-1-T2UC  
3903-1-1-T2UC  
3908-1-1-T2UC  
3901-1-1-T2UC  
3902-1-1-T2UC  
3936-1-1-T2UC  
3904-1-1-T2UC  
3951-1-1-T2UC

-----  
Ø 11 x 22mm  
Ø 10 x 22mm  
Ø 10 x 30mm  
M10 x 15mm  
M12 x 20mm  
38 x 38mm Plate  
42 x 42mm Plate

71  
71  
69  
73.5  
73.5  
75.5  
75.5

-  
22  
22  
28.5  
15  
20  
-  
-

### BLACK



### NO.

3900-2525-T2UC  
3903-2525-T2UC  
3908-2525-T2UC  
3901-2525-T2UC  
3902-2525-T2UC  
3936-2525-T2UC  
3904-2525-T2UC  
3951-2525-T2UC

-----  
Ø 11 x 22mm  
Ø 10 x 22mm  
Ø 10 x 30mm  
M10 x 15mm  
M12 x 20mm  
38 x 38mm Plate  
42 x 42mm Plate

69  
71  
71  
69  
73.5  
73.5  
75.5  
75.5

-  
22  
22  
28.5  
15  
20  
-  
-

### GREY



Ø 11 x 22mm

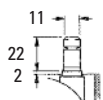

Ø 10 x 22mm

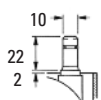

Ø 10 x 30mm

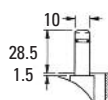

M10 x 15mm

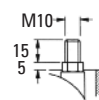

M12 x 20mm

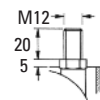

38 x 38mm Plate

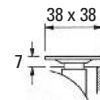

42 x 42mm Plate

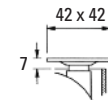

## SPECIFICATION

### CASTOR TYPE

Wheel Brake  
Conductive <100,000Ω

### MATERIALS

Castor PA  
Soft Tyre PUR

### STANDARD COLOURS

Black  
Grey

### STANDARDS

EN 12528

## TECHNISCHE DATEN

### ROLLEN TYP

Radfeststeller  
Leitfähig <100,000Ω

### MATERIAL

Rolle PA  
Weiche Lauffläche PUR

### STANDARDFARBEN

Schwarz  
Grau

### NORMEN

EN 12528

## SPECIFICATION

### TYPE DE ROULETTE

Blocage de Roue  
Antistatique <100,000Ω

### MATIERES

Roulette PA  
Bandes Souples PUR

### COLORIS STANDARD

Noir  
Gris

### NORMES

EN 12528

## ESPECIFICACION

### TIPO DE RUEDA

Freno de Rueda  
Antiestática <100,000Ω

### MATERIALES

Rueda Nilon  
Rodadura Blanda Poliuretano

### COLORES ESTANDAR

Negro  
Gris

### NORMAS

EN 12528



65



69



28



7

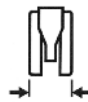

53

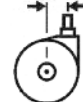

22.5



76



50kg



### NO.

3800-1-1-T2UC  
3803-1-1-T2UC  
3808-1-1-T2UC  
3801-1-1-T2UC  
3802-1-1-T2UC  
3836-1-1-T2UC  
3804-1-1-T2UC  
3851-1-1-T2UC

-----  
Ø 11 x 22mm  
Ø 10 x 22mm  
Ø 10 x 30mm  
M10 x 15mm  
M12 x 20mm  
38 x 38mm Plate  
42 x 42mm Plate

69  
71  
71  
69  
73.5  
73.5  
75.5  
75.5

-  
22  
22  
28.5  
15  
20  
-  
-

### BLACK



### NO.

3800-2525-T2UC  
3803-2525-T2UC  
3808-2525-T2UC  
3801-2525-T2UC  
3802-2525-T2UC  
3836-2525-T2UC  
3804-2525-T2UC  
3851-2525-T2UC

-----  
Ø 11 x 22mm  
Ø 10 x 22mm  
Ø 10 x 30mm  
M10 x 15mm  
M12 x 20mm  
38 x 38mm Plate  
42 x 42mm Plate

69  
71  
71  
69  
73.5  
73.5  
75.5  
75.5

-  
22  
22  
28.5  
15  
20  
-  
-

### GREY



Ø 11 x 22mm

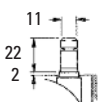

Ø 10 x 22mm

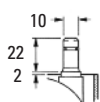

Ø 10 x 30mm

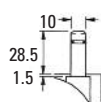

M10 x 15mm

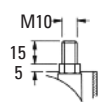

M12 x 20mm

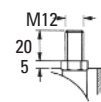

38 x 38mm Plate

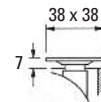

42 x 42mm Plate

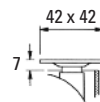

# GRX6518 & GRX6518FB CHROME CASTOR

## SPECIFICATION

### CASTOR TYPE

Swivel

Wheel Brake

### MATERIALS

Castor PA

Soft Tyre PUR

Wheel Trim Chrome Plated ABS

### STANDARD COLOURS

Black

### STANDARDS

EN 12528

## TECHNISCHE DATEN

### ROLLEN TYP

Lenkrolle

Radfeststeller

### MATERIAL

Rollen PA

Weiche Lauffläche PUR

Radkappen ABS Verchromt

### STANDARDFARBEN

Schwarz

### NORMEN

EN 12528

## SPECIFICATION

### TYPE DE ROULETTE

Pivotante

Blocage de Roue

### MATIERES

Roulette PA

Bandes Souples PUR

Enjoliveurs ABS Chromé

### COLORIS STANDARD

Noir

### NORMES

EN 12528

## ESPECIFICACION

### TIPO DE RUEDA

Giratoria

Freno de Rueda

### MATERIALES

Rueda Nilón

Rodadura Blanda Poliuretano

Tapacubos ABS Cromado

### COLORES ESTANDAR

Negro

### NORMAS

EN 12528



65



66



18



7

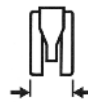

53

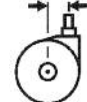

22.5



58 & 76



50kg



### NO.

6000-1-ZH  
6003-1-ZH  
6008-1-ZH  
6001-1-ZH  
6002-1-ZH  
6036-1-ZH  
6004-1-ZH  
6051-1-ZH

-----  
Ø 11 x 22mm  
Ø 10 x 22mm  
Ø 10 x 30mm  
M10 x 15mm  
M12 x 20mm  
38 x 38mm Plate  
42 x 42mm Plate

66  
69.5  
69.5  
66  
72.5  
72.5  
74.5  
74.5

-  
22  
22  
30  
15  
20  
-  
-

**GRX 6518 CHROME**  
HARD WHEEL  
LAUFFLÄCHE HART  
ROUES DURES  
RODADURA DURA



### NO.

6000-1-Z-T1U  
6003-1-Z-T1U  
6008-1-Z-T1U  
6001-1-Z-T1U  
6002-1-Z-T1U  
6036-1-Z-T1U  
6004-1-Z-T1U  
6051-1-Z-T1U

-----  
Ø 11 x 22mm  
Ø 10 x 22mm  
Ø 10 x 30mm  
M10 x 15mm  
M12 x 20mm  
38 x 38mm Plate  
42 x 42mm Plate

66  
69.5  
69.5  
66  
72.5  
72.5  
74.5  
74.5

-  
22  
22  
30  
15  
20  
-  
-

**GRX 6518 CHROME**  
SOFT TYRE  
LAUFFLÄCHE WEICH  
BANDES SOUPLES  
RODADURA BLANDA



### NO.

5100-1-ZH  
5103-1-ZH  
5108-1-ZH  
5101-1-ZH  
5102-1-ZH  
5136-1-ZH  
5104-1-ZH  
5151-1-ZH

-----  
Ø 11 x 22mm  
Ø 10 x 22mm  
Ø 10 x 30mm  
M10 x 15mm  
M12 x 20mm  
38 x 38mm Plate  
42 x 42mm Plate

66  
69.5  
69.5  
66  
72.5  
72.5  
74.5  
74.5

-  
22  
22  
30  
15  
20  
-  
-

**GRX 6518FB CHROME**  
HARD WHEEL  
LAUFFLÄCHE HART  
ROUES DURES  
RODADURA DURA



### NO.

5100-1-Z-T1U  
5103-1-Z-T1U  
5108-1-Z-T1U  
5101-1-Z-T1U  
5102-1-Z-T1U  
5136-1-Z-T1U  
5104-1-Z-T1U  
5151-1-Z-T1U

-----  
Ø 11 x 22mm  
Ø 10 x 22mm  
Ø 10 x 30mm  
M10 x 15mm  
M12 x 20mm  
38 x 38mm Plate  
42 x 42mm Plate

66  
69.5  
69.5  
66  
72.5  
72.5  
74.5  
74.5

-  
22  
22  
30  
15  
20  
-  
-

**GRX 6518FB CHROME**  
SOFT TYRE  
LAUFFLÄCHE WEICH  
BANDES SOUPLES  
RODADURA BLANDA



Ø 11 x 22mm



Ø 10 x 22mm



Ø 10 x 30mm



M10 x 15mm



M12 x 20mm



38 x 38mm Plate

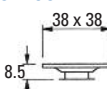

42 x 42mm Plate

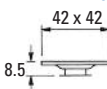

# GRX6528 & GRX6528FB CHROME CASTOR

## SPECIFICATION

### CASTOR TYPE

Swivel  
Wheel Brake  
**MATERIALS**  
Castor PA  
Soft Tyre PUR  
Wheel Trim Chrome Plated ABS

### STANDARD COLOURS

Black

### STANDARDS

EN 12528

## TECHNISCHE DATEN

### ROLLEN TYP

Lenkrolle  
Radfeststeller  
**MATERIAL**  
Rollen PA  
Weiche Lauffläche PUR  
Radkappen ABS Verchromt

### STANDARDFARBEN

Schwarz

### NORMEN

EN 12528

## SPECIFICATION

### TYPE DE ROULETTE

Pivotante  
Blocage de Roue  
**MATIERES**  
Roulette PA  
Bandes Souples PUR  
Enjoliveurs ABS Chromé

### COLORIS STANDARD

Noir

### NORMES

EN 12528

## ESPECIFICACION

### TIPO DE RUEDA

Giratoria  
Freno de Rueda  
**MATERIALES**  
Rueda Nilón  
Rodadura Blanda Poliuretano  
Tapacubos ABS Cromado

### COLORES ESTANDAR

Negro

### NORMAS

EN 12528



65



66



28



7

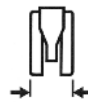

53

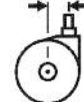

22.5



58 & 76



50kg



### NO.

3900-1-ZH  
3903-1-ZH  
3908-1-ZH  
3901-1-ZH  
3902-1-ZH  
3936-1-ZH  
3904-1-ZH  
3951-1-ZH

-----  
Ø 11 x 22mm  
Ø 10 x 22mm  
Ø 10 x 30mm  
M10 x 15mm  
M12 x 20mm  
38 x 38mm Plate  
42 x 42mm Plate

69  
71  
71  
69  
73.5  
73.5  
75.5  
75.5

-  
22  
22  
28.5  
15  
20  
-  
-

**GRX 6528 CHROME**  
HARD WHEEL  
LAUFFLÄCHE HART  
ROUES DURES  
RODADURA DURA



### NO.

3900-1-Z-T1U  
3903-1-Z-T1U  
3908-1-Z-T1U  
3901-1-Z-T1U  
3902-1-Z-T1U  
3936-1-Z-T1U  
3904-1-Z-T1U  
3951-1-Z-T1U

-----  
Ø 11 x 22mm  
Ø 10 x 22mm  
Ø 10 x 30mm  
M10 x 15mm  
M12 x 20mm  
38 x 38mm Plate  
42 x 42mm Plate

69  
71  
71  
69  
73.5  
73.5  
75.5  
75.5

-  
22  
22  
28.5  
15  
20  
-  
-

**GRX 6528 CHROME**  
SOFT TYRE  
LAUFFLÄCHE WEICH  
BANDES SOUPLES  
RODADURA BLANDA



### NO.

3800-1-ZH  
3803-1-ZH  
3808-1-ZH  
3801-1-ZH  
3802-1-ZH  
3836-1-ZH  
3804-1-ZH  
3851-1-ZH

-----  
Ø 11 x 22mm  
Ø 10 x 22mm  
Ø 10 x 30mm  
M10 x 15mm  
M12 x 20mm  
38 x 38mm Plate  
42 x 42mm Plate

69  
71  
71  
69  
73.5  
73.5  
75.5  
75.5

-  
22  
22  
28.5  
15  
20  
-  
-

**GRX 6528FB CHROME**  
HARD WHEEL  
LAUFFLÄCHE HART  
ROUES DURES  
RODADURA DURA



### NO.

3800-1-Z-T1U  
3803-1-Z-T1U  
3808-1-Z-T1U  
3801-1-Z-T1U  
3802-1-Z-T1U  
3836-1-Z-T1U  
3804-1-Z-T1U  
3851-1-Z-T1U

-----  
Ø 11 x 22mm  
Ø 10 x 22mm  
Ø 10 x 30mm  
M10 x 15mm  
M12 x 20mm  
38 x 38mm Plate  
42 x 42mm Plate

69  
71  
71  
69  
73.5  
73.5  
75.5  
75.5

-  
22  
22  
28.5  
15  
20  
-  
-

**GRX 6528FB CHROME**  
SOFT TYRE  
LAUFFLÄCHE WEICH  
BANDES SOUPLES  
RODADURA BLANDA



Ø 11 x 22mm

Ø 10 x 22mm

Ø 10 x 30mm

M10 x 15mm

M12 x 20mm

38 x 38mm Plate

42 x 42mm Plate

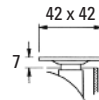
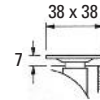
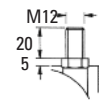
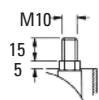
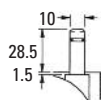
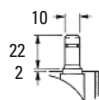
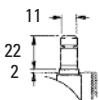

E-Mail: [info@guy-raymond.co.uk](mailto:info@guy-raymond.co.uk) Tel +44 (0)1553 761401 Fax +44 (0)1553 767459 [www.guy-raymond.com](http://www.guy-raymond.com)

© Copyright Guy-Raymond Engineering Company Limited October 2014.

We reserve the right to modify designs without prior notice.

# GRX6518 CASTOR

## SPECIFICATION

### CASTOR TYPE

Swivel

### MATERIALS

Castor PA  
Hard Wheel PA  
Soft Tyre PUR

### STANDARD COLOURS

Black  
Aluminium RAL 9006

### STANDARDS

EN 12529

## TECHNISCHE DATEN

### ROLLEN TYP

Lenkrolle

### MATERIAL

Rollen PA  
Harte Räder PA  
Weiche Lauffläche PUR

### STANDARDFARBEN

Schwarz  
Aluminium RAL 9006

### NORMEN

EN 12529

## SPECIFICATION

### TYPE DE ROULETTE

Pivotante

### MATIERES

Roulette PA  
Roue Dure PA  
Bandes Souples PUR

### COLORIS STANDARD

Noir  
Alu RAL 9006

### NORMES

EN 12529

## ESPECIFICACION

### TIPO DE RUEDA

Giratoria

### MATERIALES

Rueda Nilón  
Rodadura Dura Nilón  
Rodadura Blanda Poliuretano

### COLORES ESTANDAR

Negro  
Plateado RAL 9006

### NORMAS

EN 12529



65



66



18



7

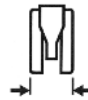

53



22.5



58



50kg



66



-

### BLACK - HARD WHEEL

### NO.

6000-1  
6003-1  
6008-1  
6001-1

-----  
Ø 11 x 22mm  
Ø 10 x 22mm  
Ø 10 x 30mm

66  
69.5  
69.5  
66

-  
22  
22  
30



### NO.

6000-1-1U  
6003-1-1U  
6008-1-1U  
6001-1-1U

-----  
Ø 11 x 22mm  
Ø 10 x 22mm  
Ø 10 x 30mm

66  
69.5  
69.5  
66

-  
22  
22  
30

### BLACK - SOFT TYRE



### NO.

6000-64  
6003-64  
6008-64  
6001-64

-----  
Ø 11 x 22mm  
Ø 10 x 22mm  
Ø 10 x 30mm

66  
69.5  
69.5  
66

-  
22  
22  
30

### RAL 9006 - HARD WHEEL



### NO.

6000-64-64-T1U  
6003-64-64-T1U  
6008-64-64-T1U  
6001-64-64-T1U

-----  
Ø 11 x 22mm  
Ø 10 x 22mm  
Ø 10 x 30mm

66  
69.5  
69.5  
66

-  
22  
22  
30

### RAL 9006 - SOFT TYRE



Ø 11 x 22mm



Ø 10 x 22mm



Ø 10 x 30mm





**SPECIFICATION**

**CASTOR TYPE**

Swivel

**MATERIALS**

Castor PA  
Hard Wheel PA  
Soft Tyre PUR

**STANDARD COLOURS**

Black  
Aluminium RAL 9006

**STANDARDS**

EN 12529

**TECHNISCHE DATEN**

**ROLLEN TYP**

Lenkrolle

**MATERIAL**

Rollen PA  
Harte Räder PA  
Weiche Lauffläche PUR

**STANDFARBEN**

Schwarz  
Aluminium RAL 9006

**NORMEN**

EN 12529

**SPECIFICATION**

**TYPE DE ROULETTE**

Pivotante

**MATIERES**

Roulette PA  
Roue Dure PA  
Bandes Souples PUR

**COLORIS STANDARD**

Noir  
Alu RAL 9006

**NORMES**

EN 12529

**ESPECIFICACION**

**TIPO DE RUEDA**

Giratoria

**MATERIALES**

Rueda Nilón  
Rodadura Dura Nilón  
Rodadura Blanda Poliuretano

**COLORES ESTANDAR**

Negro  
Plateado RAL 9006

**NORMAS**

EN 12529



65



69



28



7

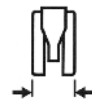

53

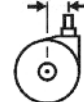

22.5



58



50kg



**NO.**

3900-1  
3903-1  
3908-1  
3901-1

-----  
Ø 11 x 22mm  
Ø 10 x 22mm  
Ø 10 x 30mm

69  
71  
71  
69

-  
22  
22  
28.5

**BLACK - HARD WHEEL**



**NO.**

3900-1-1U  
3903-1-1U  
3908-1-1U  
3901-1-1U

-----  
Ø 11 x 22mm  
Ø 10 x 22mm  
Ø 10 x 30mm

69  
71  
71  
69

-  
22  
22  
28.5

**BLACK - SOFT TYRE**



**NO.**

3900-64  
3903-64  
3908-64  
3901-64

-----  
Ø 11 x 22mm  
Ø 10 x 22mm  
Ø 10 x 30mm

69  
71  
71  
69

-  
22  
22  
28.5

**RAL 9006 - HARD WHEEL**



**NO.**

3900-64-64-T1U  
3903-64-64-T1U  
3908-64-64-T1U  
3901-64-64-T1U

-----  
Ø 11 x 22mm  
Ø 10 x 22mm  
Ø 10 x 30mm

69  
71  
71  
69

-  
22  
22  
28.5

**RAL 9006 - SOFT TYRE**



Ø 11 x 22mm

Ø 10 x 22mm

Ø 10 x 30mm

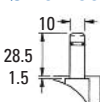
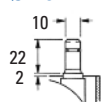
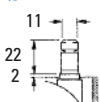

# GRX6536 CASTOR

## SPECIFICATION

### CASTOR TYPE

Swivel

### MATERIALS

Castor PA  
Hard Wheel PA  
Soft Tyre PUR

### STANDARD COLOURS

Black  
Aluminium RAL 9006

### STANDARDS

EN 12529

## TECHNISCHE DATEN

### ROLLEN TYP

Lenkrolle

### MATERIAL

Rollen PA  
Harte Räder PA  
Weiche Lauffläche PUR

### STANDARDFARBEN

Schwarz  
Aluminium RAL 9006

### NORMEN

EN 12529

## SPECIFICATION

### TYPE DE ROULETTE

Pivotante

### MATIERES

Roulette PA  
Roue Dure PA  
Bandes Souples PUR

### COLORIS STANDARD

Noir  
Alu RAL 9006

### NORMES

EN 12529

## ESPECIFICACION

### TIPO DE RUEDA

Giratoria

### MATERIALES

Rueda Nilón  
Rodadura Dura Nilón  
Rodadura Blanda Poliuretano

### COLORES ESTANDAR

Negro  
Plateado RAL 9006

### NORMAS

EN 12529



65



69



36



7



53



22.5



58



50kg



### NO.

5400-1  
5403-1  
5408-1  
5401-1

-----  
Ø 11 x 22mm  
Ø 10 x 22mm  
Ø 10 x 30mm

69  
71  
71  
69

-  
22  
22  
28.5

### BLACK - HARD WHEEL



### NO.

5400-1-1U  
5403-1-1U  
5408-1-1U  
5401-1-1U

-----  
Ø 11 x 22mm  
Ø 10 x 22mm  
Ø 10 x 30mm

69  
71  
71  
69

-  
22  
22  
28.5

### BLACK - SOFT TYRE



### NO.

5400-64  
5403-64  
5408-64  
5401-64

-----  
Ø 11 x 22mm  
Ø 10 x 22mm  
Ø 10 x 30mm

69  
71  
71  
69

-  
22  
22  
28.5

### RAL 9006 - HARD WHEEL



### NO.

5400-64-64-T1U  
5403-64-64-T1U  
5408-64-64-T1U  
5401-64-64-T1U

-----  
Ø 11 x 22mm  
Ø 10 x 22mm  
Ø 10 x 30mm

69  
71  
71  
69

-  
22  
22  
28.5

### RAL 9006 - SOFT TYRE



Ø 11 x 22mm

Ø 10 x 22mm

Ø 10 x 30mm

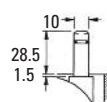
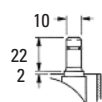
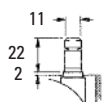

**SPECIFICATION**

**CASTOR TYPE**

Swivel

**MATERIALS**

Castor PA  
Hard Wheel PA  
Soft Tyre PUR

**STANDARD COLOURS**

Black  
Aluminium RAL 9006

**STANDARDS**

EN 12529

**TECHNISCHE DATEN**

**ROLLEN TYP**

Lenkrolle

**MATERIAL**

Rollen PA  
Harte Räder PA  
Weiche Lauffläche PUR

**STANDFARBEN**

Schwarz  
Aluminium RAL 9006

**NORMEN**

EN 12529

**SPECIFICATION**

**TYPE DE ROULETTE**

Pivotante

**MATIERES**

Roulette PA  
Roue Dure PA  
Bandes Souples PUR

**COLORIS STANDARD**

Noir  
Alu RAL 9006

**NORMES**

EN 12529

**ESPECIFICACION**

**TIPO DE RUEDA**

Giratoria

**MATERIALES**

Rueda Nilón  
Rodadura Dura Nilón  
Rodadura Blanda Poliuretano

**COLORES ESTANDAR**

Negro  
Plateado RAL 9006

**NORMAS**

EN 12529



65



69



41



7

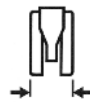

53

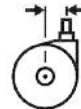

22.5



58



50kg



**NO.**

5600-1  
5603-1  
5608-1  
5601-1

-----  
Ø 11 x 22mm  
Ø 10 x 22mm  
Ø 10 x 30mm

69  
71  
71  
69

-  
22  
22  
28.5

**BLACK - HARD WHEEL**



**NO.**

5600-1-1U  
5603-1-1U  
5608-1-1U  
5601-1-1U

-----  
Ø 11 x 22mm  
Ø 10 x 22mm  
Ø 10 x 30mm

69  
71  
71  
69

-  
22  
22  
28.5

**BLACK - SOFT TYRE**



**NO.**

5600-64  
5603-64  
5608-64  
5601-64

-----  
Ø 11 x 22mm  
Ø 10 x 22mm  
Ø 10 x 30mm

69  
71  
71  
69

-  
22  
22  
28.5

**RAL 9006 - HARD WHEEL**



**NO.**

5600-64-64-T1U  
5603-64-64-T1U  
5608-64-64-T1U  
5601-64-64-T1U

-----  
Ø 11 x 22mm  
Ø 10 x 22mm  
Ø 10 x 30mm

69  
71  
71  
69

-  
22  
22  
28.5

**RAL 9006 - SOFT TYRE**



Ø 11 x 22mm

Ø 10 x 22mm

Ø 10 x 30mm

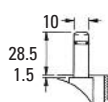
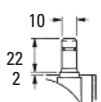
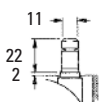

# GRX6518 & GRX6528 CHROME CASTOR

## SPECIFICATION

### CASTOR TYPE

Swivel

### MATERIALS

Castor PA

Soft Tyre PUR

Wheel Trim Chrome Plated ABS

### STANDARD COLOURS

Black

### STANDARDS

EN 12529

## TECHNISCHE DATEN

### ROLLEN TYP

Lenkrolle

### MATERIAL

Rollen PA

Weiche Lauffläche PUR

Radkappen ABS Verchromt

### STANDARDFARBEN

Schwarz

### NORMEN

EN 12529

## SPECIFICATION

### TYPE DE ROULETTE

Pivotante

### MATIERES

Roulette PA

Bandes Souples PUR

Enjoliveurs ABS Chromé

### COLORIS STANDARD

Noir

### NORMES

EN 12529

## ESPECIFICACION

### TIPO DE RUEDA

Giratoria

### MATERIALES

Rueda Nilón

Rodadura Blanda Poliuretano

Tapacubos ABS Cromado

### COLORES ESTANDAR

Negro

### NORMAS

EN 12529



65



66



18 & 28



7



53

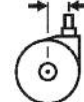

22.5



58



50kg



### NO.

6000-1-ZH

-----

66

-

6003-1-ZH

Ø 11 x 22mm

69.5

22

6008-1-ZH

Ø 10 x 22mm

69.5

22

6001-1-ZH

Ø 10 x 30mm

66

30

**GRX 6518 CHROME**  
HARD WHEEL  
LAUFFLÄCHE HART  
ROUES DURES  
RODADURA DURA



### NO.

6000-1-Z-T1U

-----

66

-

6003-1-Z-T1U

Ø 11 x 22mm

69.5

22

6008-1-Z-T1U

Ø 10 x 22mm

69.5

22

6001-1-Z-T1U

Ø 10 x 30mm

66

30

**GRX 6518 CHROME**  
SOFT TYRE  
LAUFFLÄCHE WEICH  
BANDES SOUPLES  
RODADURA BLANDA



### NO.

3900-1-ZH

-----

69

-

3903-1-ZH

Ø 11 x 22mm

71

22

3908-1-ZH

Ø 10 x 22mm

71

22

3901-1-ZH

Ø 10 x 30mm

69

28.5

**GRX 6528 CHROME**  
HARD WHEEL  
LAUFFLÄCHE HART  
ROUES DURES  
RODADURA DURA



### NO.

3900-1-Z-T1U

-----

69

-

3903-1-Z-T1U

Ø 11 x 22mm

71

22

3908-1-Z-T1U

Ø 10 x 22mm

71

22

3901-1-Z-T1U

Ø 10 x 30mm

69

28.5

**GRX 6528 CHROME**  
SOFT TYRE  
LAUFFLÄCHE WEICH  
BANDES SOUPLES  
RODADURA BLANDA



### GRX 6518

Ø 11 x 22mm



Ø 10 x 22mm

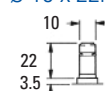

Ø 10 x 30mm

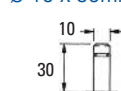

### GRX 6528

Ø 11 x 22mm

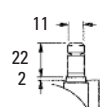

Ø 10 x 22mm

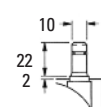

Ø 10 x 30mm

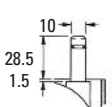

## SPECIFICATION

### CASTOR TYPE

Swivel

### MATERIALS

Castor PA

Soft Tyre PUR

Wheel Trim Chrome Plated ABS

### STANDARD COLOURS

Black

### STANDARDS

EN 12529

## TECHNISCHE DATEN

### ROLLEN TYP

Lenkrolle

### MATERIAL

Rollen PA

Weiche Lauffläche PUR

Radkappen ABS Verchromt

### STANDARDFARBEN

Schwarz

### NORMEN

EN 12529

## SPECIFICATION

### TYPE DE ROULETTE

Pivotante

### MATIERES

Roulette PA

Bandes Souples PUR

Enjoliveurs ABS Chromé

### COLORIS STANDARD

Noir

### NORMES

EN 12529

## ESPECIFICACION

### TIPO DE RUEDA

Giratoria

### MATERIALES

Rueda Nilón

Rodadura Blanda Poliuretano

Tapacubos ABS Cromado

### COLORES ESTANDAR

Negro

### NORMAS

EN 12529



65



66



36 & 41



7



53

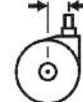

22.5



58



50kg



### NO.

5400-1-ZH

5403-1-ZH

5408-1-ZH

5401-1-ZH

-----

Ø 11 x 22mm

Ø 10 x 22mm

Ø 10 x 30mm

69

71

71

69

-

22

22

28.5

### GRX 6536 CHROME

HARD WHEEL

LAUFFLÄCHE HART

ROUES DURES

RODADURA DURA



### NO.

5400-1-Z-T1U

5403-1-Z-T1U

5408-1-Z-T1U

5401-1-Z-T1U

-----

Ø 11 x 22mm

Ø 10 x 22mm

Ø 10 x 30mm

69

71

71

69

-

22

22

28.5

### GRX 6536 CHROME

SOFT TYRE

LAUFFLÄCHE WEICH

BANDES SOUPLES

RODADURA BLANDA



### NO.

5600-1-ZH

5603-1-ZH

5608-1-ZH

5601-1-ZH

-----

Ø 11 x 22mm

Ø 10 x 22mm

Ø 10 x 30mm

69

71

71

69

-

22

22

28.5

### GRX 6541 CHROME

HARD WHEEL

LAUFFLÄCHE HART

ROUES DURES

RODADURA DURA



### NO.

5600-1-Z-T1U

5603-1-Z-T1U

5608-1-Z-T1U

5601-1-Z-T1U

-----

Ø 11 x 22mm

Ø 10 x 22mm

Ø 10 x 30mm

69

71

71

69

-

22

22

28.5

### GRX 6541 CHROME

SOFT TYRE

LAUFFLÄCHE WEICH

BANDES SOUPLES

RODADURA BLANDA



Ø 11 x 22mm

Ø 10 x 22mm

Ø 10 x 30mm

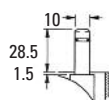
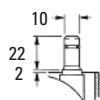
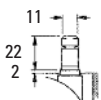



# GRX6518BU BRAKE UNLOADED CASTOR

## SPECIFICATION

### CASTOR TYPE

Brake Unloaded

### MATERIALS

Castor PA  
Hard Wheel PA  
Soft Tyre PUR

### STANDARD COLOURS

Black  
Aluminium RAL 9006

### STANDARDS

EN 12529 TYPE U

## TECHNISCHE DATEN

### ROLLEN TYP

Lastabhängig Gebremst

### MATERIAL

Rollen PA  
Harte Räder PA  
Weiche Lauffläche PUR

### STANDARDFARBEN

Schwarz  
Aluminium RAL 9006

### NORMEN

EN 12529 TYP U

## SPECIFICATION

### TYPE DE ROULETTE

Autofreiné

### MATIERES

Roulette PA  
Roue Dure PA  
Bandes Souples PUR

### COLORIS STANDARD

Noir  
Alu RAL 9006

### NORMES

EN 12529 TYPE U

## ESPECIFICACION

### TIPO DE RUEDA

Autofrenado

### MATERIALES

Rueda Nilón  
Rodadura Dura Nilón  
Rodadura Blanda Poliuretano

### COLORES ESTANDAR

Negro  
Plateado RAL 9006

### NORMAS

EN 12529 TIPO U



65



67



18



7

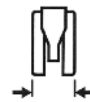

53

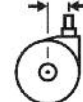

22.5



58



50kg



### NO.

8800-1  
8803-1  
8808-1  
8801-1

-----  
Ø 11 x 22mm  
Ø 10 x 22mm  
Ø 10 x 30mm

67  
70.5  
70.5  
67

-  
22  
22  
30

### BLACK - HARD WHEEL



### NO.

8800-1-1U  
8803-1-1U  
8808-1-1U  
8801-1-1U

-----  
Ø 11 x 22mm  
Ø 10 x 22mm  
Ø 10 x 30mm

67  
70.5  
70.5  
67

-  
22  
22  
30

### BLACK - SOFT TYRE



### NO.

8800-64  
8803-64  
8808-64  
8801-64

-----  
Ø 11 x 22mm  
Ø 10 x 22mm  
Ø 10 x 30mm

67  
70.5  
70.5  
67

-  
22  
22  
30

### RAL 9006 - HARD WHEEL



### NO.

8800-64-64-T1U  
8803-64-64-T1U  
8808-64-64-T1U  
8801-64-64-T1U

-----  
Ø 11 x 22mm  
Ø 10 x 22mm  
Ø 10 x 30mm

67  
70.5  
70.5  
67

-  
22  
22  
30

### RAL 9006 - SOFT TYRE



Ø 11 x 22mm



Ø 10 x 22mm



Ø 10 x 30mm



## SPECIFICATION

### CASTOR TYPE

Brake Unloaded

### MATERIALS

Castor PA  
Hard Wheel PA  
Soft Tyre PUR

### STANDARD COLOURS

Black  
Aluminium RAL 9006

### STANDARDS

EN 12529 TYPE U

## TECHNISCHE DATEN

### ROLLEN TYP

Lastabhängig Gebremst

### MATERIAL

Rollen PA  
Harte Räder PA  
Weiche Lauffläche PUR

### STANDARDFARBEN

Schwarz  
Aluminium RAL 9006

### NORMEN

EN 12529 TYP U

## SPECIFICATION

### TYPE DE ROULETTE

Autofreiné

### MATIERES

Roulette PA  
Roue Dure PA  
Bandes Souples PUR

### COLORIS STANDARD

Noir  
Alu RAL 9006

### NORMES

EN 12529 TYPE U

## ESPECIFICACION

### TIPO DE RUEDA

Autofrenado

### MATERIALES

Rueda Nilón  
Rodadura Dura Nilón  
Rodadura Blanda Poliuretano

### COLORES ESTANDAR

Negro  
Plateado RAL 9006

### NORMAS

EN 12529 TIPO U



65



70



28



7



53



22.5



58



50kg



### NO.

6100-1  
6103-1  
6108-1  
6101-1

-----  
Ø 11 x 22mm  
Ø 10 x 22mm  
Ø 10 x 30mm

70  
72  
72  
70

-  
22  
22  
28.5

### BLACK - HARD WHEEL



### NO.

6100-1-1U  
6103-1-1U  
6108-1-1U  
6101-1-1U

-----  
Ø 11 x 22mm  
Ø 10 x 22mm  
Ø 10 x 30mm

70  
72  
72  
70

-  
22  
22  
28.5

### BLACK - SOFT TYRE

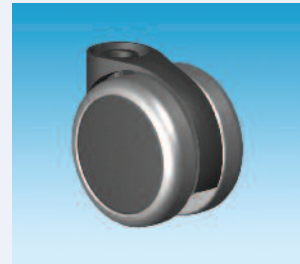

### NO.

6100-64  
6103-64  
6108-64  
6101-64

-----  
Ø 11 x 22mm  
Ø 10 x 22mm  
Ø 10 x 30mm

70  
72  
72  
70

-  
22  
22  
28.5

### RAL 9006 - HARD WHEEL



### NO.

6100-64-64-T1U  
6103-64-64-T1U  
6108-64-64-T1U  
6101-64-64-T1U

-----  
Ø 11 x 22mm  
Ø 10 x 22mm  
Ø 10 x 30mm

70  
72  
72  
70

-  
22  
22  
28.5

### RAL 9006 - SOFT TYRE



Ø 11 x 22mm

Ø 10 x 22mm

Ø 10 x 30mm

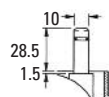
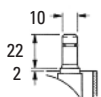
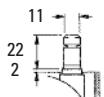

# GRX6536BU BRAKE UNLOADED CASTOR

## SPECIFICATION

### CASTOR TYPE

Brake Unloaded

### MATERIALS

Castor PA  
Hard Wheel PA  
Soft Tyre PUR

### STANDARD COLOURS

Black  
Aluminium RAL 9006

### STANDARDS

EN 12529 TYPE U

## TECHNISCHE DATEN

### ROLLEN TYP

Lastabhängig Gebremst

### MATERIAL

Rollen PA  
Harte Räder PA  
Weiche Lauffläche PUR

### STANDARDFARBEN

Schwarz  
Aluminium RAL 9006

### NORMEN

EN 12529 TYP U

## SPECIFICATION

### TYPE DE ROULETTE

Autofreiné

### MATIERES

Roulette PA  
Roue Dure PA  
Bandes Souples PUR

### COLORIS STANDARD

Noir  
Alu RAL 9006

### NORMES

EN 12529 TYPE U

## ESPECIFICACION

### TIPO DE RUEDA

Autofrenado

### MATERIALES

Rueda Nilón  
Rodadura Dura Nilón  
Rodadura Blanda Poliuretano

### COLORES ESTANDAR

Negro  
Plateado RAL 9006

### NORMAS

EN 12529 TIPO U



65



70



36



7



53

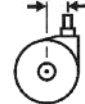

22.5



58



50kg



### NO.

8100-1  
8103-1  
8108-1  
8101-1

-----  
Ø 11 x 22mm  
Ø 10 x 22mm  
Ø 10 x 30mm

70  
72  
72  
70

-  
22  
22  
28.5

### BLACK - HARD WHEEL



### NO.

8100-1-1U  
8103-1-1U  
8108-1-1U  
8101-1-1U

-----  
Ø 11 x 22mm  
Ø 10 x 22mm  
Ø 10 x 30mm

70  
72  
72  
70

-  
22  
22  
28.5

### BLACK - SOFT TYRE

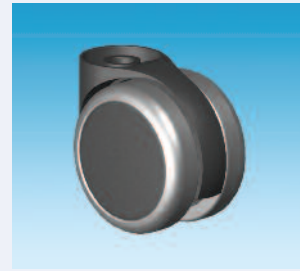

### NO.

8100-64  
8103-64  
8108-64  
8101-64

-----  
Ø 11 x 22mm  
Ø 10 x 22mm  
Ø 10 x 30mm

70  
72  
72  
70

-  
22  
22  
28.5

### RAL 9006 - HARD WHEEL



### NO.

8100-64-64-T1U  
8103-64-64-T1U  
8108-64-64-T1U  
8101-64-64-T1U

-----  
Ø 11 x 22mm  
Ø 10 x 22mm  
Ø 10 x 30mm

70  
72  
72  
70

-  
22  
22  
28.5

### RAL 9006 - SOFT TYRE



Ø 11 x 22mm

Ø 10 x 22mm

Ø 10 x 30mm

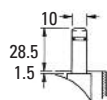
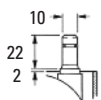
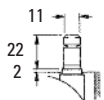

## SPECIFICATION

### CASTOR TYPE

Brake Unloaded

### MATERIALS

Castor PA  
Hard Wheel PA  
Soft Tyre PUR

### STANDARD COLOURS

Black  
Aluminium RAL 9006

### STANDARDS

EN 12529 TYPE U

## TECHNISCHE DATEN

### ROLLEN TYP

Lastabhängig Gebremst

### MATERIAL

Rollen PA  
Harte Räder PA  
Weiche Lauffläche PUR

### STANDARDFARBEN

Schwarz  
Aluminium RAL 9006

### NORMEN

EN 12529 TYP U

## SPECIFICATION

### TYPE DE ROULETTE

Autofreiné

### MATIERES

Roulette PA  
Roue Dure PA  
Bandes Souples PUR

### COLORIS STANDARD

Noir  
Alu RAL 9006

### NORMES

EN 12529 TYPE U

## ESPECIFICACION

### TIPO DE RUEDA

Autofrenado

### MATERIALES

Rueda Nilón  
Rodadura Dura Nilón  
Rodadura Blanda Poliuretano

### COLORES ESTANDAR

Negro  
Plateado RAL 9006

### NORMAS

EN 12529 TIPO U



65



70



41



7



53

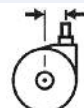

22.5



58



50kg



### NO.

4300-1  
4303-1  
4308-1  
4301-1

-----  
Ø 11 x 22mm  
Ø 10 x 22mm  
Ø 10 x 30mm

70  
72  
72  
70

-  
22  
22  
28.5

### BLACK - HARD WHEEL



### NO.

4300-1-1U  
4303-1-1U  
4308-1-1U  
4301-1-1U

-----  
Ø 11 x 22mm  
Ø 10 x 22mm  
Ø 10 x 30mm

70  
72  
72  
70

-  
22  
22  
28.5

### BLACK - SOFT TYRE



### NO.

4300-64  
4303-64  
4308-64  
4301-64

-----  
Ø 11 x 22mm  
Ø 10 x 22mm  
Ø 10 x 30mm

70  
72  
72  
70

-  
22  
22  
28.5

### RAL 9006 - HARD WHEEL



### NO.

4300-64-64-T1U  
4303-64-64-T1U  
4308-64-64-T1U  
4301-64-64-T1U

-----  
Ø 11 x 22mm  
Ø 10 x 22mm  
Ø 10 x 30mm

70  
72  
72  
70

-  
22  
22  
28.5

### RAL 9006 - SOFT TYRE



Ø 11 x 22mm

Ø 10 x 22mm

Ø 10 x 30mm

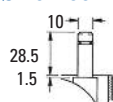
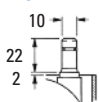
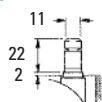

# GRX6518BU & GRX6528BU CHROME CASTOR

## SPECIFICATION

### CASTOR TYPE

Brake Unloaded

### MATERIALS

Castor PA

Soft Tyre PUR

Wheel Trim Chrome Plated ABS

### STANDARD COLOURS

Black

### STANDARDS

EN 12529

## TECHNISCHE DATEN

### ROLLEN TYP

Lastabhängig Gebremst

### MATERIAL

Rollen PA

Weiche Lauffläche PUR

Radkappen ABS Verchromt

### STANDARDFARBEN

Schwarz

### NORMEN

EN 12529

## SPECIFICATION

### TYPE DE ROULETTE

Autofreiné

### MATIERES

Roulette PA

Bandes Souples PUR

Enjoliveurs ABS Chromé

### COLORIS STANDARD

Noir

### NORMES

EN 12529

## ESPECIFICACION

### TIPO DE RUEDA

Autofrenado

### MATERIALES

Rueda Nilón

Rodadura Blanda Poliuretano

Tapacubos ABS Cromado

### COLORES ESTANDAR

Negro

### NORMAS

EN 12529



65



66



18 & 28



7

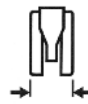

53

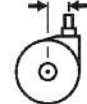

22.5



58



50kg

### NO.

8800-1-ZH

8803-1-ZH

8808-1-ZH

8801-1-ZH



-----

Ø 11 x 22mm

Ø 10 x 22mm

Ø 10 x 30mm



67

70.5

70.5

67



-

22

22

30

### GRX 6518BU CHROME

HARD WHEEL

LAUFFLÄCHE HART

ROUES DURES

RODADURA DURA



### NO.

8800-1-Z-T1U

8803-1-Z-T1U

8808-1-Z-T1U

8801-1-Z-T1U

-----

Ø 11 x 22mm

Ø 10 x 22mm

Ø 10 x 30mm

67

70.5

70.5

67

-

22

22

30

### GRX 6518BU CHROME

SOFT TYRE

LAUFFLÄCHE WEICH

BANDES SOUPLES

RODADURA BLANDA



### NO.

6100-1-ZH

6103-1-ZH

6108-1-ZH

6101-1-ZH

-----

Ø 11 x 22mm

Ø 10 x 22mm

Ø 10 x 30mm

70

72

72

70

-

22

22

28.5

### GRX 6528BU CHROME

HARD WHEEL

LAUFFLÄCHE HART

ROUES DURES

RODADURA DURA



### NO.

6100-1-Z-T1U

6103-1-Z-T1U

6108-1-Z-T1U

6101-1-Z-T1U

-----

Ø 11 x 22mm

Ø 10 x 22mm

Ø 10 x 30mm

70

72

72

70

-

22

22

28.5

### GRX 6528BU CHROME

SOFT TYRE

LAUFFLÄCHE WEICH

BANDES SOUPLES

RODADURA BLANDA



### GRX 6518BU

Ø 11 x 22mm



Ø 10 x 22mm

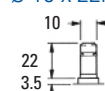

Ø 10 x 30mm

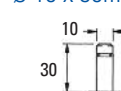

### GRX 6528BU

Ø 11 x 22mm

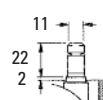

Ø 10 x 22mm

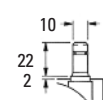

Ø 10 x 30mm

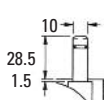



# GRX6536BU & GRX6541BU CHROME CASTOR

## SPECIFICATION

### CASTOR TYPE

Brake Unloaded

### MATERIALS

Castor PA

Soft Tyre PUR

Wheel Trim Chrome Plated ABS

### STANDARD COLOURS

Black

### STANDARDS

EN 12529

## TECHNISCHE DATEN

### ROLLEN TYP

Lastabhängig Gebremst

### MATERIAL

Rollen PA

Weiche Lauffläche PUR

Radkappen ABS Verchromt

### STANDARDFARBEN

Schwarz

### NORMEN

EN 12529

## SPECIFICATION

### TYPE DE ROULETTE

Autofreiné

### MATIERES

Roulette PA

Bandes Souples PUR

Enjoliveurs ABS Chromé

### COLORIS STANDARD

Noir

### NORMES

EN 12529

## ESPECIFICACION

### TIPO DE RUEDA

Autofrenado

### MATERIALES

Rueda Nilón

Rodadura Blanda Poliuretano

Tapacubos ABS Cromado

### COLORES ESTANDAR

Negro

### NORMAS

EN 12529



65



66



36 & 41



7



53

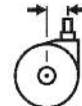

22.5



58



50kg



### NO.

8100-1-ZH

8103-1-ZH

8108-1-ZH

8101-1-ZH

-----

Ø 11 x 22mm

Ø 10 x 22mm

Ø 10 x 30mm

70

72

72

70

-

22

22

28.5

### GRX 6536BU CHROME

HARD WHEEL

LAUFFLÄCHE HART

ROUES DURES

RODADURA DURA



### NO.

8100-1-Z-T1U

8103-1-Z-T1U

8108-1-Z-T1U

8101-1-Z-T1U

-----

Ø 11 x 22mm

Ø 10 x 22mm

Ø 10 x 30mm

70

72

72

70

-

22

22

28.5

### GRX 6536BU CHROME

SOFT TYRE

LAUFFLÄCHE WEICH

BANDES SOUPLES

RODADURA BLANDA

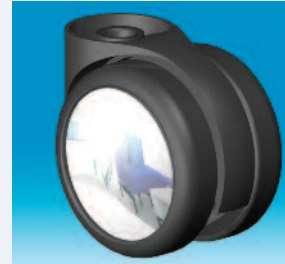

### NO.

4300-1-ZH

4303-1-ZH

4308-1-ZH

4301-1-ZH

-----

Ø 11 x 22mm

Ø 10 x 22mm

Ø 10 x 30mm

70

72

72

70

-

22

22

28.5

### GRX 6541BU CHROME

HARD WHEEL

LAUFFLÄCHE HART

ROUES DURES

RODADURA DURA



### NO.

4300-1-Z-T1U

4303-1-Z-T1U

4308-1-Z-T1U

4301-1-Z-T1U

-----

Ø 11 x 22mm

Ø 10 x 22mm

Ø 10 x 30mm

70

72

72

70

-

22

22

28.5

### GRX 6541BU CHROME

SOFT TYRE

LAUFFLÄCHE WEICH

BANDES SOUPLES

RODADURA BLANDA

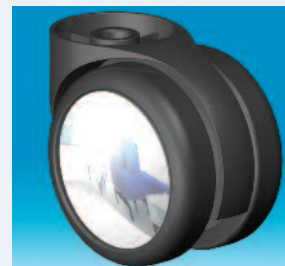

Ø 11 x 22mm

Ø 10 x 22mm

Ø 10 x 30mm

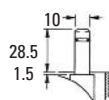
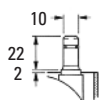
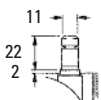

# GRX6518HT CASTOR

## SPECIFICATION

### CASTOR TYPE

Swivel

### MATERIALS

Castor PA  
Hard Wheel PA  
Soft Tyre PUR

### STANDARD COLOURS

Black  
Aluminium RAL 9006

### STANDARDS

EN 12528  
EN 12529

## TECHNISCHE DATEN

### ROLLEN TYP

Lenkrolle

### MATERIAL

Rollen PA  
Harte Räder PA  
Weiche Lauffläche PUR

### STANDARDFARBEN

Schwarz  
Aluminium RAL 9006

### NORMEN

EN 12528  
EN 12529

## SPECIFICATION

### TYPE DE ROULETTE

Pivotante

### MATIERES

Roulette PA  
Roue Dure PA  
Bandes Souples PUR

### COLORIS STANDARD

Noir  
Alu RAL 9006

### NORMES

EN 12528  
EN 12529

## ESPECIFICACION

### TIPO DE RUEDA

Giratoria

### MATERIALES

Rueda Nilón  
Rodadura Dura Nilón  
Rodadura Blanda Poliuretano

### COLORES ESTANDAR

Negro  
Plateado RAL 9006

### NORMAS

EN 12528  
EN 12529



65



81



18



7

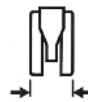

53

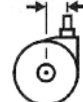

22.5



58



50kg



### NO.

NO.		81	-
6K00-1	-----	81	-
6K92-1	Ø 11 x 22mm	84.5	22
6K91-1	Ø 10 x 22mm	84.5	22
6K89-1	Ø 10 x 30mm	81	30
6K93-1	M10 x 15mm	87.5	15
6K97-1	M12 x 20mm	87.5	20
6K96-1	38 x 38mm Plate	89.5	-
6K95-1	42 x 42mm Plate	89.5	-

### BLACK - HARD WHEEL



### NO.

NO.		81	-
6K00-1-1U	-----	81	-
6K92-1-1U	Ø 11 x 22mm	84.5	22
6K91-1-1U	Ø 10 x 22mm	84.5	22
6K89-1-1U	Ø 10 x 30mm	81	30
6K93-1-1U	M10 x 15mm	87.5	15
6K97-1-1U	M12 x 20mm	87.5	20
6K96-1-1U	38 x 38mm Plate	89.5	-
6K95-1-1U	42 x 42mm Plate	89.5	-

### BLACK - SOFT TYRE



### NO.

NO.		81	-
6K00-64	-----	81	-
6K92-64	Ø 11 x 22mm	84.5	22
6K91-64	Ø 10 x 22mm	84.5	22
6K89-64	Ø 10 x 30mm	81	30
6K93-64	M10 x 15mm	87.5	15
6K97-64	M12 x 20mm	87.5	20
6K96-64	38 x 38mm Plate	89.5	-
6K95-64	42 x 42mm Plate	89.5	-

### RAL 9006 - HARD WHEEL



### NO.

NO.		81	-
6K00-64-64-T1U	-----	81	-
6K92-64-64-T1U	Ø 11 x 22mm	84.5	22
6K91-64-64-T1U	Ø 10 x 22mm	84.5	22
6K89-64-64-T1U	Ø 10 x 30mm	81	30
6K93-64-64-T1U	M10 x 15mm	87.5	15
6K97-64-64-T1U	M12 x 20mm	87.5	20
6K96-64-64-T1U	38 x 38mm Plate	89.5	-
6K95-64-64-T1U	42 x 42mm Plate	89.5	-

### RAL 9006 - SOFT TYRE



Ø 11 x 22mm



Ø 10 X 22mm



Ø 10 x 30mm



M10 x 15mm

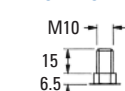

M12 x 20mm



38 x 38mm Plate

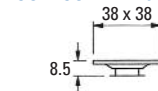

42 x 42mm Plate

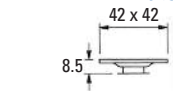

\* Note:  
See page 43

## SPECIFICATION

### CASTOR TYPE

Brake Unloaded

### MATERIALS

Castor PA

Hard Wheel PA

Soft Tyre PUR

### STANDARD COLOURS

Black

Aluminium RAL 9006

### STANDARDS

EN 12529 TYPE U

## TECHNISCHE DATEN

### ROLLEN TYP

Lastabhängig Gebremst

### MATERIAL

Rollen PA

Harte Räder PA

Weiche Lauffläche PUR

### STANDARDFARBEN

Schwarz

Aluminium RAL 9006

### NORMEN

EN 12529 TYP U

## SPECIFICATION

### TYPE DE ROULETTE

Autofreiné

### MATIERES

Roulette PA

Roue Dure PA

Bandes Souples PUR

### COLORIS STANDARD

Noir

Alu RAL 9006

### NORMES

EN 12529 TYPE U

## ESPECIFICACION

### TIPO DE RUEDA

Autofrenado

### MATERIALES

Rueda Nilón

Rodadura Dura Nilón

Rodadura Blanda Poliuretano

### COLORES ESTANDAR

Negro

Plateado RAL 9006

### NORMAS

EN 12529 TIPO U



65



82



18



7

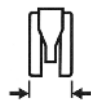

53

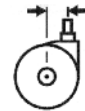

22.5



58



50kg



### NO.

6L00-1

6L92-1

6L91-1

6L89-1

-----  
 Ø 11 x 22mm  
 Ø 10 x 22mm  
 Ø 10 x 30mm

82

85.5

85.5

82

-

22

22

30

### BLACK - HARD WHEEL



### NO.

6L00-1-1U

6L92-1-1U

6L91-1-1U

6L89-1-1U

-----  
 Ø 11 x 22mm  
 Ø 10 x 22mm  
 Ø 10 x 30mm

82

85.5

85.5

82

-

22

22

30

### BLACK - SOFT TYRE



### NO.

6L00-64

6L92-64

6L91-64

6L89-64

-----  
 Ø 11 x 22mm  
 Ø 10 x 22mm  
 Ø 10 x 30mm

82

85.5

85.5

82

-

22

22

30

### RAL 9006 - HARD WHEEL



### NO.

6L00-64-64-T1U

6L92-64-64-T1U

6L91-64-64-T1U

6L89-64-64-T1U

-----  
 Ø 11 x 22mm  
 Ø 10 x 22mm  
 Ø 10 x 30mm

82

85.5

85.5

82

-

22

22

30

### RAL 9006 - SOFT TYRE



Ø 11 x 22mm

Ø 10 x 22mm

Ø 10 x 30mm



\* Note: Fittings are 15mm longer inside castor

## INTRODUCTION

The GRX75 range of castors has a nominal wheel diameter of 75mm, and a load capacity of 75 kgs per castor. The GRX75 is available as either a freewheel swivel castor or a total lock (simultaneously the swivel and wheels are locked) castor.

Total lock dramatically reduces the problem of unexpected swivel movement associated with simple wheel brake castors. Total lock castors give a far more rigid feel to the locked unit.

All castors are offered with a long life polyurethane tyre as standard.

## EINFÜHRUNG

Die GRX75 Rollen haben einen Raddurchmesser von 75mm und eine Lastfähigkeit von 75kg pro Rolle. Sie ist entweder freilaufend oder mit einem Totalfeststeller erhältlich welcher das Drehen der Räder und die Schwenkung des Stiftes bremsst.

Der Totalfeststeller verhindert unerwartete Bewegungen die bei einfachen rad-gebremsten Rollen auftreten können. Dies bedeutet, mehr Stabilität für Ihre Produkte. Die GRX75 Rolle besitzt standardmäßig eine hochwertige und langlebige Polyurethan Lauffläche.

## INTRODUCTION

Les roulettes de la gamme GRX75 ont des roues de diamètre 75mm, et supportent une charge de 75 kgs par roulette. La GRX75 est disponible en modèle non freiné ou blocage total (blocage des roues et de la fixation).

Le blocage total réduit considérablement le problème associé aux roulettes avec un simple frein à pied, qui continuent à pivoter après l'engagement du frein. L'avantage du blocage total est l'assurance d'une meilleure stabilité du meuble sur lequel la roulette est montée.

Toutes les roulettes sont équipées de bandes souples en polyuréthane garantissant une grande longévité.

## INTRODUCCION

Las ruedas de la gama GRX75 tienen ruedas de diámetro 75mm, y una capacidad de carga de 75 kgs por rueda. La GRX75 está disponible como modelo sin freno o traba total (traba las ruedas y la fijación).

La traba total reduce considerablemente el problema de ruedas que continúan girando cuando el freno es embragada. La ventaja de la traba total es la mejora solidez del producto para lo cual la rueda es utilizada.

Todas estas ruedas tienen una rodadura blanda en poliuretano durable como estándar.

## FEATURES

- GRX Design
- Patented dust/grease shield
- Polyamide housing
- Polyamide mechanism
- Solid riveted axle zinc plated
- Polyamide soft tyre hub
- Polyurethane soft tyre

## EIGENSCHAFTEN:

- GRX Design
- Patentierter Achsenschutz
- Polyamid Gehäuse
- Polyamid Mechanik
- Stabile vernietete und verzinkte Achse
- Polyamid Rad
- Polyurethan Lauffläche

## CARACTERISTIQUES

- Design GRX
- Capot de protection de l'axe contre la poussière - breveté
- Capot en polyamide
- Mécanisme en polyamide
- Roues rivetées sur l'axe zinguée
- Roues en polyamide
- Bandes souples en polyuréthane

## ELEMENTOS

- Diseño GRX
- Protector del eje contra el polvo (patentado)
- Producto de PA (Nilón)
- Mecanismo de PA (Nilón)
- Ruedas remachadas en el eje chapado de zinc
- Ruedas de PA (Nilón)
- Rodadura blanda de poliuretano



## APPLICATIONS

- Medical equipment
- Home care furniture
- Office furniture
- Industrial chairs
- Domestic furniture
- Beds
- TV / video / audio stands
- Shop and display
- Equipment

## ANWENDUNGEN:

- Medizinische Geräte
- Pflegemöbiliar
- Mobile Büromöbel
- Industrie Stühle
- Im Wohnbereich
- Betten
- TV/Video/Hi-Fi Schänke
- Ladenbau
- Mobile Geräte

## APPLICATIONS

- Equipement médical
- Mobilier HAD-MAD
- Meubles de bureau
- Sièges de travail
- Meubles domestiques
- Lits
- Meubles de TV / video / hi-fi
- Aménagement de magasins
- Autre équipement

## USOS

- Equipo médico
- Mobiliario para asistencia domestica
- Mueble de oficina
- Sillas de trabajo
- Muebles domesticos
- Camas
- Muebles para TV / video / equipo de alta fidelidad
- Equipo de tiendas
- Otro equipo

## FITTINGS

Guy-Raymond manufactures a wide range of standard fittings, these are shown on the opposite page. In addition Guy-Raymond can design and develop a special fitting. Unless otherwise agreed stems/fittings will be supplied assembled into the castors as it is important that the stem is fitted correctly particularly on the total lock models. The stems are different on the freewheel swivel and the total lock models.

## BEFESTIGUNGEN:

Guy-Raymond bietet viele verschiedene Befestigungsmöglichkeiten, welche Sie auf der nächsten Seite finden. Zusätzlich haben wir die Möglichkeit mit Ihnen eine Sonderfixierung zu entwickeln. Standardmäßig werden die Rollen mit der Befestigung montiert geliefert um korrekte Montage für den Totalfeststeller zu versichern.

## FIXATIONS

Guy-Raymond fabrique une gamme étendue de fixations standard – celles-ci sont présentées sur la page en face. De plus Guy-Raymond peut dessiner et développer des fixations spéciales. Sauf accord contraire, les fixations et les roulettes seront fournies montées parce qu'un montage correct de la tige est essentiel, surtout pour le modèle à blocage total. Les fixations du modèle à blocage total sont différentes de celles du modèle non freiné.

## FIJACIONES

Guy-Raymond fabrica una gran gama de fijaciones estándar – estas son presentadas en la página enfrente. Además Guy-Raymond puede diseñar y desarrollar fijaciones especiales. A menos que convenga al contrario, las fijaciones y las ruedas serán suministradas montadas por que el montaje correcto de la fijación es imprescindible, sobre todo para el modelo traba total. Las fijaciones del modelo traba total son diferentes que las del modelo sin freno.

## SPECIFICATION MATERIALS

Steel BZP

## TECHNISCHE DATEN MATERIAL

Stahl Verzinkt

## SPECIFICATION MATIERES

Acier, plaqué de zinc

## ESPECIFICACION MATERIALES

Acero chapado de zinc

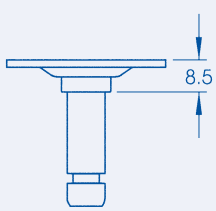
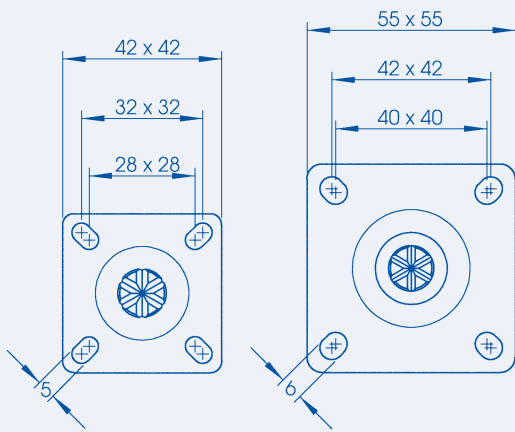

PLATE FIXING  
No.1959-9211

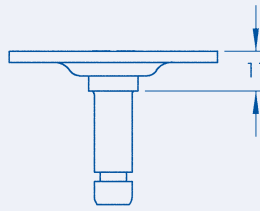
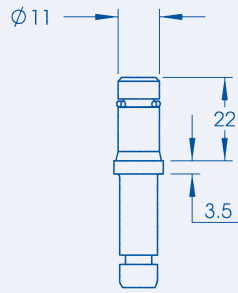
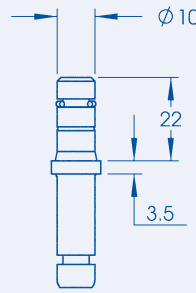

PLATE FIXING  
No.1942-9215



No.1954P



No.1957P

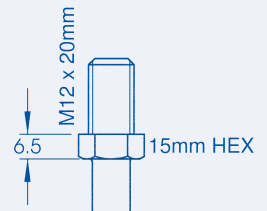

M12 x 20  
No.1983P

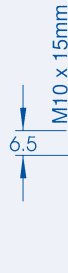

M10 x 15  
No.1955P



M10 x 20  
No.1962P



M10 x 25  
No.1963P



M10 x 30  
No.1945P

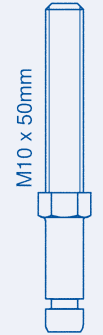

M10 x 50  
No.19B4P

## GRX75TL TOTAL LOCK FITTINGS

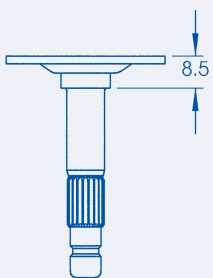
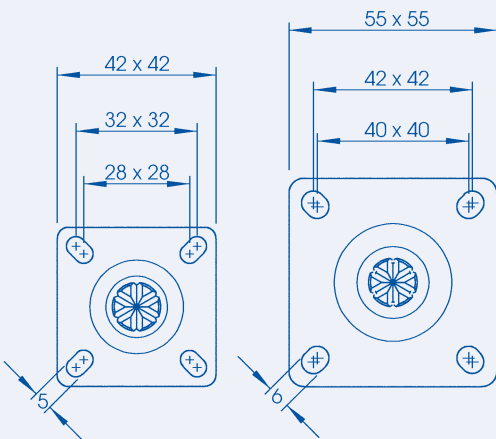

PLATE FIXING  
No.1996-9211

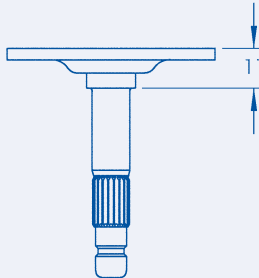
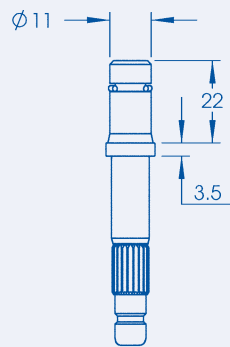
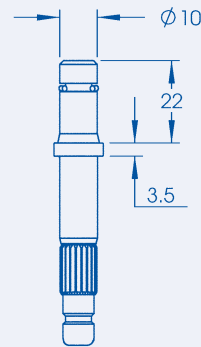

PLATE FIXING  
No.1941-9215



No.1997P



No.1998P

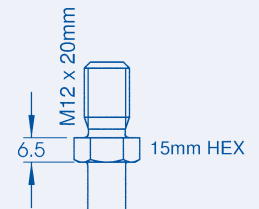

M12 x 20  
No.1995P



M10 x 15  
No.1993P



M10 x 20  
No.19B2P



M10 x 25  
No.19D2P



M10 x 30  
No.1938P

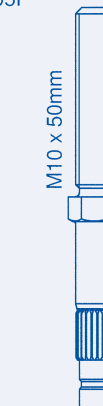

M10 x 50  
No.19C6P



# GRX7522 CASTOR

## SPECIFICATION

### CASTOR TYPE

Swivel

### MATERIALS

Castor PA

Soft Tyre PUR

### STANDARD COLOURS

Black

Aluminium RAL 9006

Grey RAL 7035

White RAL 9003

### STANDARDS

EN 12530

## TECHNISCHE DATEN

### ROLLEN TYP

Lenkrolle

### MATERIAL

Rollen PA

Weiche Lauffläche PUR

### STANDARDFARBEN

Schwarz

Aluminium RAL 9006

Lichtgrau RAL 7035

Weiss RAL 9003

### NORMEN

EN 12530

## SPECIFICATION

### TYPE DE ROULETTE

Pivotante

### MATIERES

Roulette PA

Bandes Souples PUR

### COLORIS STANDARD

Noir

Alu RAL 9006

Gris Clair RAL 7035

Blanc RAL 9003

### NORMES

EN 12530

## ESPECIFICACION

### TIPO DE RUEDA

Giratoria

### MATERIALES

Rueda Nilón

Rodadura Blanda Poliuretano

### COLORES ESTANDAR

Negro

Plateado RAL 9006

Gris RAL 7035

Blanco RAL 9003

### NORMAS

EN 12530



75



80



22



10

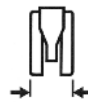

54

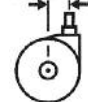

23.5



65



Up to 75kg(x)  
(x)Depends on fixing

### NO.

NO.		80	-	BLACK
6A00-1-1	-----	80	-	
6A02-1-1	M10 x 15mm	86.5	15	
6A36-1-1	M12 x 20mm	86.5	20	
6A03-1-1	Ø 11 x 22mm	83.5	22	
6A08-1-1	Ø 10 x 22mm	83.5	22	
6A51-1-1	42 x 42mm Plate	88.5	-	
6A09-1-1	55 x 55mm Plate	91	-	

### NO.

NO.		80	-	ALUMINIUM RAL 9006
6A00-64-64-T1	-----	80	-	
6A02-64-64-T1	M10 x 15mm	86.5	15	
6A36-64-64-T1	M12 x 20mm	86.5	20	
6A03-64-64-T1	Ø 11 x 22mm	83.5	22	
6A08-64-64-T1	Ø 10 x 22mm	83.5	22	
6A51-64-64-T1	42 x 42mm Plate	88.5	-	
6A09-64-64-T1	55 x 55mm Plate	91	-	

### NO.

NO.		80	-	GREY RAL 7035
6A00-25-25	-----	80	-	
6A02-25-25	M10 x 15mm	86.5	15	
6A36-25-25	M12 x 20mm	86.5	20	
6A03-25-25	Ø 11 x 22mm	83.5	22	
6A08-25-25	Ø 10 x 22mm	83.5	22	
6A51-25-25	42 x 42mm Plate	88.5	-	
6A09-25-25	55 x 55mm Plate	91	-	

### NO.

NO.		80	-	WHITE RAL 9003
6A00-3-3	-----	80	-	
6A02-3-3	M10 x 15mm	86.5	15	
6A36-3-3	M12 x 20mm	86.5	20	
6A03-3-3	Ø 11 x 22mm	83.5	22	
6A08-3-3	Ø 10 x 22mm	83.5	22	
6A51-3-3	42 x 42mm Plate	88.5	-	
6A09-3-3	55 x 55mm Plate	91	-	

M10 x 15mm



M12 x 20mm



Ø 11 x 22mm



Ø 10 x 22mm



42 x 42mm Plate

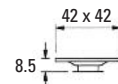

55 x 55mm Plate

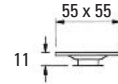

## SPECIFICATION

### CASTOR TYPE

Total Locking

### MATERIALS

Castor PA

Soft Tyre PUR

### STANDARD COLOURS

Black

Aluminium RAL 9006

Grey RAL 7035

White RAL 9003

### STANDARDS

EN 12530

## TECHNISCHE DATEN

### ROLLEN TYP

Totalfeststeller

### MATERIAL

Rollen PA

Weiche Lauffläche PUR

### STANDARDFARBEN

Schwarz

Aluminium RAL 9006

Lichtgrau RAL 7035

Weiss RAL 9003

### NORMEN

EN 12530

## SPECIFICATION

### TYPE DE ROULETTE

Blocage Total

### MATIERES

Roulette PA

Bandes Souples PUR

### COLORIS STANDARD

Noir

Alu RAL 9006

Gris Clair RAL 7035

Blanc RAL 9003

### NORMES

EN 12530

## ESPECIFICACION

### TIPO DE RUEDA

Traba Total

### MATERIALES

Rueda Nilón

Rodadura Blanda Poliuretano

### COLORES ESTANDAR

Negro

Plateado RAL 9006

Gris RAL 7035

Blanco RAL 9003

### NORMAS

EN 12530



75



80



22



10



54

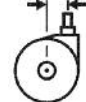

23.5



84



Up to 75kg(x)

(x) Depends on fixing



### NO.

6B00-1-1

6B71-1-1

6B73-1-1

6B79-1-1

6B80-1-1

6B70-1-1

6B77-1-1

-----

M10 x 15mm

M12 x 20mm

Ø 11 x 22mm

Ø 10 x 22mm

42 x 42mm Plate

55 x 55mm Plate

80

86.5

86.5

83.5

83.5

88.5

91

-

15

20

22

22

-

-

### BLACK



### NO.

6B00-64-64-T1

6B71-64-64-T1

6B73-64-64-T1

6B79-64-64-T1

6B80-64-64-T1

6B70-64-64-T1

6B77-64-64-T1

-----

M10 x 15mm

M12 x 20mm

Ø 11 x 22mm

Ø 10 x 22mm

42 x 42mm Plate

55 x 55mm Plate

80

86.5

86.5

83.5

83.5

88.5

91

-

15

20

22

22

-

-

### ALUMINIUM RAL 9006



### NO.

6B00-25-25

6B71-25-25

6B73-25-25

6B79-25-25

6B80-25-25

6B70-25-25

6B77-25-25

-----

M10 x 15mm

M12 x 20mm

Ø 11 x 22mm

Ø 10 x 22mm

42 x 42mm Plate

55 x 55mm Plate

80

86.5

86.5

83.5

83.5

88.5

91

-

15

20

22

22

-

-

### GREY RAL 7035



### NO.

6B00-3-3

6B71-3-3

6B73-3-3

6B79-3-3

6B80-3-3

6B70-3-3

6B77-3-3

-----

M10 x 15mm

M12 x 20mm

Ø 11 x 22mm

Ø 10 x 22mm

42 x 42mm Plate

55 x 55mm Plate

80

86.5

86.5

83.5

83.5

88.5

91

-

15

20

22

22

-

-

### WHITE RAL 9003



M10 x 15mm

M12 x 20mm

Ø 11 x 22mm

Ø 10 x 22mm

42 x 42mm Plate

55 x 55mm Plate

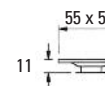
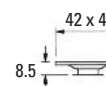
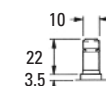
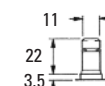
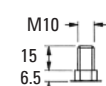

# GRX7522 CONDUCTIVE CASTOR

## SPECIFICATION

### CASTOR TYPE

Swivel  
Conductive <100,000Ω

### MATERIALS

Castor PA  
Soft Tyre PUR

### STANDARD COLOURS

Black  
Grey

### STANDARDS

EN 12530

## TECHNISCHE DATEN

### ROLLEN TYP

Lenkrolle  
Leitfähig <100,000Ω

### MATERIAL

Rolle PA  
Weiche Lauffläche PUR

### STANDARDFARBEN

Schwarz  
Grau

### NORMEN

EN 12530

## SPECIFICATION

### TYPE DE ROULETTE

Pivotante  
Antistatique <100,000Ω

### MATIERES

Roulette PA  
Bandes Souples PUR

### COLORIS STANDARD

Noir  
Gris

### NORMES

EN 12530

## ESPECIFICACION

### TIPO DE RUEDA

Giratoria  
Antiestática <100,000Ω

### MATERIALES

Rueda Nilón  
Rodadura Blanda Poliuretano

### COLORES ESTANDAR

Negro  
Gris

### NORMAS

EN 12530



75



80



22



10



54



23.5



65



Up to 75kg(x)  
(x)Depends on fixing

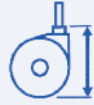

### NO.

6A00-1-1-T2C	-----	80	-
6A02-1-1-T2C	M10 x 15mm	86.5	15
6A36-1-1-T2C	M12 x 20mm	86.5	20
6A03-1-1-T2C	Ø 11 x 22mm	83.5	22
6A08-1-1-T2C	Ø 10 x 22mm	83.5	22
6A51-1-1-T2C	42 x 42mm Plate	88.5	-
6A09-1-1-T2C	55 x 55mm Plate	91	-

### BLACK



### NO.

6A00-25-73-T2C	-----	80	-
6A02-25-73-T2C	M10 x 15mm	86.5	15
6A36-25-73-T2C	M12 x 20mm	86.5	20
6A03-25-73-T2C	Ø 11 x 22mm	83.5	22
6A08-25-73-T2C	Ø 10 x 22mm	83.5	22
6A51-25-73-T2C	42 x 42mm Plate	88.5	-
6A09-25-73-T2C	55 x 55mm Plate	91	-

### GREY



M10 x 15mm



M12 x 20mm



Ø 11 x 22mm



Ø 10 x 22mm



42 x 42mm Plate

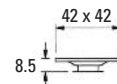

55 x 55mm Plate

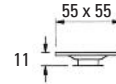

# GRX7522TL CONDUCTIVE TOTAL LOCK CASTOR

## SPECIFICATION

### CASTOR TYPE

Total Locking  
Conductive <100,000Ω

### MATERIALS

Castor PA  
Soft Tyre PUR

### STANDARD COLOURS

Black  
Grey

### STANDARDS

EN 12530

## TECHNISCHE DATEN

### ROLLEN TYP

Totalfeststeller  
Leitfähig <100,000Ω

### MATERIAL

Rolle PA  
Weiche Lauffläche PUR

### STANDARDFARBEN

Schwarz  
Grau

### NORMEN

EN 12530

## SPECIFICATION

### TYPE DE ROULETTE

Blocage Total  
Antistatique <100,000Ω

### MATIERES

Roulette PA  
Bandes Souples PUR

### COLORIS STANDARD

Noir  
Gris

### NORMES

EN 12530

## ESPECIFICACION

### TIPO DE RUEDA

Freno Total  
Antiestática <100,000Ω

### MATERIALES

Rueda Nilón  
Rodadura Blanda Poliuretano

### COLORES ESTANDAR

Negro  
Gris

### NORMAS

EN 12530



75



80



22



10



54

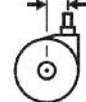

23.5



84



Up to 75kg(x)

(x) Depends on fixing



### NO.

6B00-1-1-T2C  
6B71-1-1-T2C  
6B73-1-1-T2C  
6B79-1-1-T2C  
6B80-1-1-T2C  
6B70-1-1-T2C  
6B77-1-1-T2C

-----  
M10 x 15mm  
M12 x 20mm  
Ø 11 x 22mm  
Ø 10 x 22mm  
42 x 42mm Plate  
55 x 55mm Plate

80  
86.5  
86.5  
83.5  
83.5  
88.5  
91

-  
15  
20  
22  
22  
-  
-

### BLACK



### NO.

6B00-25-73-T2C  
6B71-25-73-T2C  
6B73-25-73-T2C  
6B79-25-73-T2C  
6B80-25-73-T2C  
6B70-25-73-T2C  
6B77-25-73-T2C

-----  
M10 x 15mm  
M12 x 20mm  
Ø 11 x 22mm  
Ø 10 x 22mm  
42 x 42mm Plate  
55 x 55mm Plate

80  
86.5  
86.5  
83.5  
83.5  
88.5  
91

-  
15  
20  
22  
22  
-  
-

### GREY



M10 x 15mm

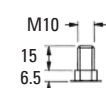

M12 x 20mm



Ø 11 x 22mm

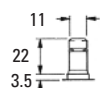

Ø 10 x 22mm

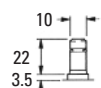

42 x 42mm Plate

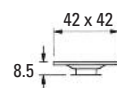

55 x 55mm Plate

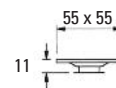

# GRX7536 CASTOR

## SPECIFICATION

### CASTOR TYPE

Swivel

### MATERIALS

Castor PA

Soft Tyre PUR

### STANDARD COLOURS

Black

Aluminium RAL 9006

Grey RAL 7035

White RAL 9003

### STANDARDS

EN 12530

## TECHNISCHE DATEN

### ROLLEN TYP

Lenkrolle

### MATERIAL

Rollen PA

Weiche Lauffläche PUR

### STANDARDFARBEN

Schwarz

Aluminium RAL 9006

Lichtgrau RAL 7035

Weiss RAL 9003

### NORMEN

EN 12530

## SPECIFICATION

### TYPE DE ROULETTE

Pivotante

### MATIERES

Roulette PA

Bandes Souples PUR

### COLORIS STANDARD

Noir

Alu RAL 9006

Gris Clair RAL 7035

Blanc RAL 9003

### NORMES

EN 12530

## ESPECIFICACION

### TIPO DE RUEDA

Giratoria

### MATERIALES

Rueda Nilón

Rodadura Blanda Poliuretano

### COLORES ESTANDAR

Negro

Plateado RAL 9006

Gris RAL 7035

Blanco RAL 9003

### NORMAS

EN 12530



75



80



36



10

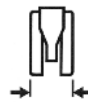

54

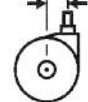

23.5



65



Up to 75kg(x)  
(x)Depends on fixing

### NO.

4500-1-1  
4502-1-1  
4536-1-1  
4503-1-1  
4508-1-1  
4551-1-1  
4509-1-1



-----  
M10 x 15mm  
M12 x 20mm  
Ø 11 x 22mm  
Ø 10 x 22mm  
42 x 42mm Plate  
55 x 55mm Plate

80  
86.5  
86.5  
83.5  
83.5  
88.5  
91



-  
15  
20  
22  
22  
-  
-

### BLACK

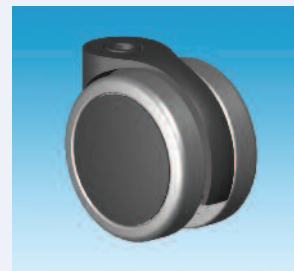

### NO.

4500-64-64-T1  
4502-64-64-T1  
4536-64-64-T1  
4503-64-64-T1  
4508-64-64-T1  
4551-64-64-T1  
4509-64-64-T1

-----  
M10 x 15mm  
M12 x 20mm  
Ø 11 x 22mm  
Ø 10 x 22mm  
42 x 42mm Plate  
55 x 55mm Plate

80  
86.5  
86.5  
83.5  
83.5  
88.5  
91

-  
15  
20  
22  
22  
-  
-

### ALUMINIUM - RAL 9006



### NO.

4500-25-25  
4502-25-25  
4536-25-25  
4503-25-25  
4508-25-25  
4551-25-25  
4509-25-25

-----  
M10 x 15mm  
M12 x 20mm  
Ø 11 x 22mm  
Ø 10 x 22mm  
42 x 42mm Plate  
55 x 55mm Plate

80  
86.5  
86.5  
83.5  
83.5  
88.5  
91

-  
15  
20  
22  
22  
-  
-

### GREY - RAL 7035



### NO.

4500-3-3  
4502-3-3  
4536-3-3  
4503-3-3  
4508-3-3  
4551-3-3  
4509-3-3

-----  
M10 x 15mm  
M12 x 20mm  
Ø 11 x 22mm  
Ø 10 x 22mm  
42 x 42mm Plate  
55 x 55mm Plate

80  
86.5  
86.5  
83.5  
83.5  
88.5  
91

-  
15  
20  
22  
22  
-  
-

### WHITE - RAL 9003



M10 X 15mm



M12 X 20mm



Ø 11 X 22mm

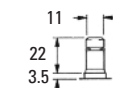

Ø 10 X 22mm

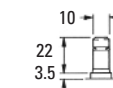

42 X 42mm Plate

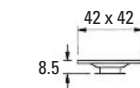

55 X 55mm Plate





# GRX7536TL TOTAL LOCK CASTOR

## SPECIFICATION

### CASTOR TYPE

Total Lock

### MATERIALS

Castor PA

Soft Tyre PUR

### STANDARD COLOURS

Black

Aluminium RAL 9006

Grey RAL 7035

White RAL 9003

### STANDARDS

EN 12530

## TECHNISCHE DATEN

### ROLLEN TYP

Totalfeststeller

### MATERIAL

Rollen PA

Weiche Lauffläche PUR

### STANDARDFARBEN

Schwarz

Aluminium RAL 9006

Lichtgrau RAL 7035

Weiss RAL 9003

### NORMEN

EN 12530

## SPECIFICATION

### TYPE DE ROULETTE

Blocage Total

### MATIERES

Roulette PA

Bandes Souples PUR

### COLORIS STANDARD

Noir

Alu RAL 9006

Gris Clair RAL 7035

Blanc RAL 9003

### NORMES

EN 12530

## ESPECIFICACION

### TIPO DE RUEDA

Traba Total

### MATERIALES

Rueda Nilón

Rodadura Blanda Poliuretano

### COLORES ESTANDAR

Negro

Plateado RAL 9006

Gris RAL 7035

Blanco RAL 9003

### NORMAS

EN 12530



75



80



36



10

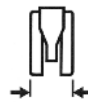

54



23.5



84



Up to 75kg(x)  
(x)Depends on fixing



### NO.

4600-1-1  
4671-1-1  
4673-1-1  
4679-1-1  
4680-1-1  
4670-1-1  
4677-1-1

-----  
M10 x 15mm  
M12 x 20mm  
Ø 11 x 22mm  
Ø 10 x 22mm  
42 x 42 mm Plate  
55 x 55 mm Plate

80  
86.5  
86.5  
83.5  
83.5  
88.5  
91

-  
15  
20  
22  
22  
-  
-

### BLACK



### NO.

4600-64-64-T1  
4671-64-64-T1  
4673-64-64-T1  
4679-64-64-T1  
4680-64-64-T1  
4670-64-64-T1  
4677-64-64-T1

-----  
M10 x 15mm  
M12 x 20mm  
Ø 11 x 22mm  
Ø 10 x 22mm  
42 x 42 mm Plate  
55 x 55 mm Plate

80  
86.5  
86.5  
83.5  
83.5  
88.5  
91

-  
15  
20  
22  
22  
-  
-

### ALUMINIUM - RAL 9006



### NO.

4600-25-25  
4671-25-25  
4673-25-25  
4679-25-25  
4680-25-25  
4670-25-25  
4677-25-25

-----  
M10 x 15mm  
M12 x 20mm  
Ø 11 x 22mm  
Ø 10 x 22mm  
42 x 42 mm Plate  
55 x 55 mm Plate

80  
86.5  
86.5  
83.5  
83.5  
88.5  
91

-  
15  
20  
22  
22  
-  
-

### GREY - RAL 7035



### NO.

4600-3-3  
4671-3-3  
4673-3-3  
4679-3-3  
4680-3-3  
4670-3-3  
4677-3-3

-----  
M10 x 15mm  
M12 x 20mm  
Ø 11 x 22mm  
Ø 10 x 22mm  
42 x 42 mm Plate  
55 x 55 mm Plate

80  
86.5  
86.5  
83.5  
83.5  
88.5  
91

-  
15  
20  
22  
22  
-  
-

### WHITE - RAL 9003



M10 x 15mm



M12 x 20mm



Ø 11 x 22mm

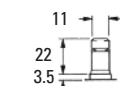

Ø 10 x 22mm

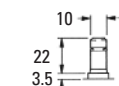

42 x 42mm Plate

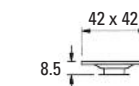

55 X 55mm Plate

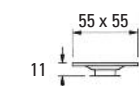

# GRX7536 CONDUCTIVE CASTOR

## SPECIFICATION

### CASTOR TYPE

Swivel  
Conductive <100,000Ω

### MATERIALS

Castor PA  
Soft Tyre PUR

### STANDARD COLOURS

Black  
Grey

### STANDARDS

EN 12530

## TECHNISCHE DATEN

### ROLLEN TYP

Lenkrolle  
Leitfähig <100,000Ω

### MATERIAL

Rolle PA  
Weiche Lauffläche PUR

### STANDARDFARBEN

Schwarz  
Grau

### NORMEN

EN 12530

## SPECIFICATION

### TYPE DE ROULETTE

Pivotante  
Antistatique <100,000Ω

### MATIERES

Roulette PA  
Bandes Souples PUR

### COLORIS STANDARD

Noir  
Gris

### NORMES

EN 12530

## ESPECIFICACION

### TIPO DE RUEDA

Giratoria  
Antiestática <100,000Ω

### MATERIALES

Rueda Nilón  
Rodadura Blanda Poliuretano

### COLORES ESTANDAR

Negro  
Gris

### NORMAS

EN 12530



75



80



36



10



54



23.5



65



Up to 75kg(x)  
(x)Depends on fixing



### NO.

4500-1-1-T2C  
4502-1-1-T2C  
4536-1-1-T2C  
4503-1-1-T2C  
4508-1-1-T2C  
4551-1-1-T2C  
4509-1-1-T2C

-----  
M10 x 15mm  
M12 x 20mm  
Ø 11 x 22mm  
Ø 10 x 22mm  
42 x 42mm Plate  
55 x 55mm Plate

80  
86.5  
86.5  
83.5  
83.5  
88.5  
91

-  
15  
20  
22  
22  
-  
-

### BLACK



### NO.

4500-25-73-T2C  
4502-25-73-T2C  
4536-25-73-T2C  
4503-25-73-T2C  
4508-25-73-T2C  
4551-25-73-T2C  
4509-25-73-T2C

-----  
M10 x 15mm  
M12 x 20mm  
Ø 11 x 22mm  
Ø 10 x 22mm  
42 x 42mm Plate  
55 x 55mm Plate

80  
86.5  
86.5  
83.5  
83.5  
88.5  
91

-  
15  
20  
22  
22  
-  
-

### GREY



M10 x 15mm



M12 x 20mm



Ø 11 x 22mm



Ø 10 x 22mm



42 x 42mm Plate

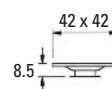

55 x 55mm Plate

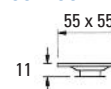

# GRX7536TL CONDUCTIVE TOTAL LOCK CASTOR

## SPECIFICATION

### CASTOR TYPE

Total Lock  
Conductive <100,000Ω

### MATERIALS

Castor PA  
Soft Tyre PUR

### STANDARD COLOURS

Black  
Grey

### STANDARDS

EN 12530

## TECHNISCHE DATEN

### ROLLEN TYP

Totalfeststeller  
Leitfähig <100,000Ω

### MATERIAL

Rolle PA  
Weiche Lauffläche PUR

### STANDARDFARBEN

Schwarz  
Grau

### NORMEN

EN 12530

## SPECIFICATION

### TYPE DE ROULETTE

Blocage Total  
Antistatique <100,000Ω

### MATIERES

Roulette PA  
Bandes Souples PUR

### COLORIS STANDARD

Noir  
Gris

### NORMES

EN 12530

## ESPECIFICACION

### TIPO DE RUEDA

Traba Total  
Antiestática <100,000Ω

### MATERIALES

Rueda Nilón  
Rodadura Blanda Poliuretano

### COLORES ESTANDAR

Negro  
Gris

### NORMAS

EN 12530



75



80



36



10



54

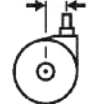

23.5



84



Up to 75kg(x)  
(x)Depends on fixing



### NO.

4600-1-1-T2C  
4671-1-1-T2C  
4673-1-1-T2C  
4679-1-1-T2C  
4680-1-1-T2C  
4670-1-1-T2C  
4677-1-1-T2C

-----  
M10 x 15mm  
M12 x 20mm  
Ø 11 x 22mm  
Ø 10 x 22mm  
42 x 42 mm Plate  
55 x 55 mm Plate

80  
86.5  
86.5  
83.5  
83.5  
88.5  
91

-  
15  
20  
22  
22  
-  
-

### BLACK



### NO.

4600-25-73-T2C  
4671-25-73-T2C  
4673-25-73-T2C  
4679-25-73-T2C  
4680-25-73-T2C  
4670-25-73-T2C  
4677-25-73-T2C

-----  
M10 x 15mm  
M12 x 20mm  
Ø 11 x 22mm  
Ø 10 x 22mm  
42 x 42 mm Plate  
55 x 55 mm Plate

80  
86.5  
86.5  
83.5  
83.5  
88.5  
91

-  
15  
20  
22  
22  
-  
-

### GREY



M10 x 15mm



M12 x 20mm



Ø 11 x 22mm



Ø 10 x 22mm



42 x 42mm Plate

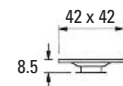

55 x 55mm Plate



# GRX7522 & GRX7522TL CHROME CASTOR

## SPECIFICATION

### CASTOR TYPE

GRX7522 Swivel  
GRX7522TL Total Lock

### MATERIALS

Castor PA  
Soft Tyre PUR  
Wheel Trim Chrome Plated ABS

### STANDARD COLOURS

Black

### STANDARDS

EN 12530

## TECHNISCHE DATEN

### ROLLEN TYP

GRX7522 Lenkrolle  
GRX7522TL Totalfeststeller

### MATERIAL

Rolle PA  
Weiche Lauffläche PUR  
Radkappen ABS Verchromt

### STANDARDFARBEN

Schwarz

### NORMEN

EN 12530

## SPECIFICATION

### TYPE DE ROULETTE

GRX7522 Pivotante  
GRX7522TL Blocage Total

### MATIERES

Roulette PA  
Bandes Souples PUR  
Enjoliveurs ABS Chromé

### COLORIS STANDARD

Noir

### NORMES

EN 12530

## ESPECIFICACION

### TIPO DE RUEDA

GRX7522 Giratoria  
GRX7522TL Freno Total

### MATERIALES

Rueda Nilón  
Rodadura Blanda Poliuretano  
Tapacubos ABS Cromado

### COLORES ESTANDAR

Negro

### NORMAS

EN 12530



75



80



36



10



54

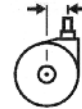

23.5



65 & 84



Up to 75kg(x)

(x) Depends on fixing

### NO.

6A00-1-Z-T1  
6A02-1-Z-T1  
6A36-1-Z-T1  
6A03-1-Z-T1  
6A08-1-Z-T1  
6A51-1-Z-T1  
6A09-1-Z-T1



M10 x 15mm  
M12 x 20mm  
Ø11 x 22mm  
Ø10 x 22mm  
42 x 42mm Plate  
55 x 55mm Plate



80  
86.5  
86.5  
83.5  
83.5  
88.5  
91



-  
15  
20  
22  
22  
-  
-

### GRX7522 CHROME



### NO.

6B00-1-Z-T1  
6B71-1-Z-T1  
6B73-1-Z-T1  
6B79-1-Z-T1  
6B80-1-Z-T1  
6B70-1-Z-T1  
6B77-1-Z-T1

M10 x 15mm  
M12 x 20mm  
Ø11 x 22mm  
Ø10 x 22mm  
42 x 42mm Plate  
55 x 55mm Plate

80  
86.5  
86.5  
83.5  
83.5  
88.5  
91

-  
15  
20  
22  
22  
-  
-

### GRX7522TL CHROME



### NO.

6A00-1-ZM-T1  
6A02-1-ZM-T1  
6A36-1-ZM-T1  
6A03-1-ZM-T1  
6A08-1-ZM-T1  
6A51-1-ZM-T1  
6A09-1-ZM-T1

M10 x 15mm  
M12 x 20mm  
Ø11 x 22mm  
Ø10 x 22mm  
42 x 42mm Plate  
55 x 55mm Plate

80  
86.5  
86.5  
83.5  
83.5  
88.5  
91

-  
15  
20  
22  
22  
-  
-

### GRX7522 MATT CHROME



### NO.

6B00-1-ZM-T1  
6B71-1-ZM-T1  
6B73-1-ZM-T1  
6B79-1-ZM-T1  
6B80-1-ZM-T1  
6B70-1-ZM-T1  
6B77-1-ZM-T1

M10 x 15mm  
M12 x 20mm  
Ø11 x 22mm  
Ø10 x 22mm  
42 x 42mm Plate  
55 x 55mm Plate

80  
86.5  
86.5  
83.5  
83.5  
88.5  
91

-  
15  
20  
22  
22  
-  
-

### GRX7522TL MATT CHROME



M10 x 15mm



M12 x 20mm



Ø 11 x 22mm



Ø 10 x 22mm



42 x 42mm Plate

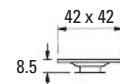

55 x 55mm Plate

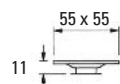

# GRX7522 & GRX7522TL GOLD CASTOR

## SPECIFICATION

### CASTOR TYPE

GRX7522 Swivel  
GRX7522TL Total Lock

### MATERIALS

Castor PA  
Soft Tyre PUR  
Wheel Trim Gold Plated ABS

### STANDARD COLOURS

Black

### STANDARDS

EN 12530

## TECHNISCHE DATEN

### ROLLEN TYP

GRX7522 Lenkrolle  
GRX7522TL Totalfeststeller

### MATERIAL

Rolle PA  
Weiche Lauffläche PUR  
Radkappen ABS Vergoldet

### STANDARDFARBEN

Schwarz

### NORMEN

EN 12530

## SPECIFICATION

### TYPE DE ROULETTE

GRX7522 Pivotante  
GRX7522TL Blocage Total

### MATIERES

Roulette PA  
Bandes Souples PUR  
Enjoliveurs ABS Plaquage Or

### COLORIS STANDARD

Noir

### NORMES

EN 12530

## ESPECIFICACION

### TIPO DE RUEDA

GRX7522 Giratoria  
GRX7522TL Traba Total

### MATERIALES

Rueda Nilón  
Rodadura Blanda Poliuretano  
Tapacubos ABS Chapado En Oro

### COLORES ESTANDAR

Negro

### NORMAS

EN 12530



75



80



36



10



54

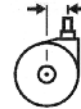

23.5



65 & 84



Up to 75kg(x)

(x) Depends on fixing

### NO.

6A00-1-G-T1  
6A02-1-G-T1  
6A36-1-G-T1  
6A03-1-G-T1  
6A08-1-G-T1  
6A51-1-G-T1  
6A09-1-G-T1



M10 x 15mm

M12 x 20mm

Ø11 x 22mm

Ø10 x 22mm

42 x 42mm Plate

55 x 55mm Plate



80

86.5

86.5

83.5

83.5

88.5

91



-

15

20

22

22

-

-

### GRX7522 GOLD



### NO.

6B00-1-G-T1  
6B71-1-G-T1  
6B73-1-G-T1  
6B79-1-G-T1  
6B80-1-G-T1  
6B70-1-G-T1  
6B77-1-G-T1

-----

M10 x 15mm

M12 x 20mm

Ø11 x 22mm

Ø10 x 22mm

42 x 42mm Plate

55 x 55mm Plate

80

86.5

86.5

83.5

83.5

88.5

91

-

15

20

22

22

-

-

### GRX7522TL GOLD



### NO.

6A00-1-GM-T1  
6A02-1-GM-T1  
6A36-1-GM-T1  
6A03-1-GM-T1  
6A08-1-GM-T1  
6A51-1-GM-T1  
6A09-1-GM-T1

-----

M10 x 15mm

M12 x 20mm

Ø11 x 22mm

Ø10 x 22mm

42 x 42mm Plate

55 x 55mm Plate

80

86.5

86.5

83.5

83.5

88.5

91

-

15

20

22

22

-

-

### GRX7522 MATT GOLD



### NO.

6B00-1-GM-T1  
6B71-1-GM-T1  
6B73-1-GM-T1  
6B79-1-GM-T1  
6B80-1-GM-T1  
6B70-1-GM-T1  
6B77-1-GM-T1

-----

M10 x 15mm

M12 x 20mm

Ø11 x 22mm

Ø10 x 22mm

42 x 42mm Plate

55 x 55mm Plate

80

86.5

86.5

83.5

83.5

88.5

91

-

15

20

22

22

-

-

### GRX7522TL MATT GOLD



M10 x 15mm

M12 x 20mm

Ø 11 x 22mm

Ø 10 x 22mm

42 x 42mm Plate

55 x 55mm Plate



15  
6.5



20  
6.5



11  
22  
3.5



10  
22  
3.5

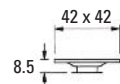

8.5



11

E-Mail: [info@guy-raymond.co.uk](mailto:info@guy-raymond.co.uk) Tel +44 (0)1553 761401 Fax +44 (0)1553 767459 [www.guy-raymond.com](http://www.guy-raymond.com)

© Copyright Guy-Raymond Engineering Company Limited October 2014.

We reserve the right to modify designs without prior notice.



# GRX7536 & GRX7536TL CHROME CASTOR

## SPECIFICATION

### CASTOR TYPE

GRX7536 Swivel  
GRX7536TL Total Lock

### MATERIALS

Castor PA  
Soft Tyre PUR  
Wheel Trim Chrome Plated ABS

### STANDARD COLOURS

Black

### STANDARDS

EN 12530

## TECHNISCHE DATEN

### ROLLEN TYP

GRX7536 Lenkrolle  
GRX7536TL Totalfeststeller

### MATERIAL

Rolle PA  
Weiche Lauffläche PUR  
Radkappen ABS Verchromt

### STANDARDFARBEN

Schwarz

### NORMEN

EN 12530

## SPECIFICATION

### TYPE DE ROULETTE

GRX7536 Pivotante  
GRX7536TL Blocage Total

### MATIERES

Roulette PA  
Bandes Souples PUR  
Enjoliveurs ABS Chromé

### COLORIS STANDARD

Noir

### NORMES

EN 12530

## ESPECIFICACION

### TIPO DE RUEDA

GRX7536 Giratoria  
GRX7536TL Freno Total

### MATERIALES

Rueda Nilón  
Rodadura Blanda Poliuretano  
Tapacubos ABS Cromado

### COLORES ESTANDAR

Negro

### NORMAS

EN 12530



75



80



36



10



54



23.5



65 & 84



Up to 75kg(x)  
(x) Depends on fixing

### NO.

4500-1-Z-T1  
4502-1-Z-T1  
4536-1-Z-T1  
4503-1-Z-T1  
4508-1-Z-T1  
4551-1-Z-T1  
4509-1-Z-T1



-----

M10 x 15mm

M12 x 20mm

Ø11 x 22mm

Ø10 x 22mm

42 x 42mm Plate

55 x 55mm Plate



80

86.5

86.5

83.5

83.5

88.5

91



-

15

20

22

22

-

-

### GRX7536 CHROME



### NO.

4600-1-Z-T1  
4671-1-Z-T1  
4673-1-Z-T1  
4679-1-Z-T1  
4680-1-Z-T1  
4670-1-Z-T1  
4677-1-Z-T1

-----

M10 x 15mm

M12 x 20mm

Ø11 x 22mm

Ø10 x 22mm

42 x 42mm Plate

55 x 55mm Plate

80

86.5

86.5

83.5

83.5

88.5

91

-

15

20

22

22

-

-

### GRX7536TL CHROME



### NO.

4500-1-ZM-T1  
4502-1-ZM-T1  
4536-1-ZM-T1  
4503-1-ZM-T1  
4508-1-ZM-T1  
4551-1-ZM-T1  
4509-1-ZM-T1

-----

M10 x 15mm

M12 x 20mm

Ø11 x 22mm

Ø10 x 22mm

42 x 42mm Plate

55 x 55mm Plate

80

86.5

86.5

83.5

83.5

88.5

91

-

15

20

22

22

-

-

### GRX7536 MATT CHROME

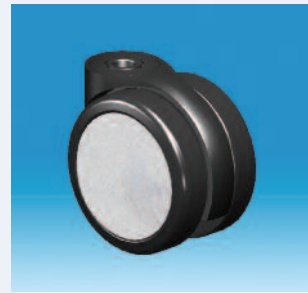

### NO.

4600-1-ZM-T1  
4671-1-ZM-T1  
4673-1-ZM-T1  
4679-1-ZM-T1  
4680-1-ZM-T1  
4670-1-ZM-T1  
4677-1-ZM-T1

-----

M10 x 15mm

M12 x 20mm

Ø11 x 22mm

Ø10 x 22mm

42 x 42mm Plate

55 x 55mm Plate

80

86.5

86.5

83.5

83.5

88.5

91

-

15

20

22

22

-

-

### GRX7536TL MATT CHROME



M10 x 15mm

M12 x 20mm

Ø 11 x 22mm

Ø 10 x 22mm

42 x 42mm Plate

55 x 55mm Plate



15

6.5



20

6.5



11

3.5



10

3.5

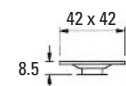

8.5

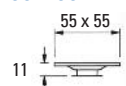

11

## SPECIFICATION

### CASTOR TYPE

GRX7536 Swivel  
GRX7536TL Total Lock

### MATERIALS

Castor PA  
Soft Tyre PUR  
Wheel Trim Gold Plated ABS

### STANDARD COLOURS

Black

### STANDARDS

EN 12530

## TECHNISCHE DATEN

### ROLLEN TYP

GRX7536 Lenkrolle  
GRX7536TL Totalfeststeller

### MATERIAL

Rolle PA  
Weiche Lauffläche PUR  
Radkappen ABS Vergoldet

### STANDARDFARBEN

Schwarz

### NORMEN

EN 12530

## SPECIFICATION

### TYPE DE ROULETTE

GRX7536 Pivotante  
GRX7536TL Blocage Total

### MATIERES

Roulette PA  
Bandes Souples PUR  
Enjoliveurs ABS Plaquage Or

### COLORIS STANDARD

Noir

### NORMES

EN 12530

## ESPECIFICACION

### TIPO DE RUEDA

GRX7536 Giratoria  
GRX7536TL Freno Total

### MATERIALES

Rueda Nilón  
Rodadura Blanda Poliuretano  
Tapacubos ABS Chapado En Oro

### COLORES ESTANDAR

Negro

### NORMAS

EN 12530



75



80



36



10



54

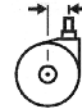

23.5



65 & 84



Up to 75kg(x)  
(x) Depends on fixing

### NO.

4500-1-G-T1  
4502-1-G-T1  
4536-1-G-T1  
4503-1-G-T1  
4508-1-G-T1  
4551-1-G-T1  
4509-1-G-T1



-----

M10 x 15mm

M12 x 20mm

Ø11 x 22mm

Ø10 x 22mm

42 x 42mm Plate

55 x 55mm Plate



80

86.5

86.5

83.5

83.5

88.5

91



-

15

20

22

22

-

-

### GRX7536 GOLD



### NO.

4600-1-G-T1  
4671-1-G-T1  
4673-1-G-T1  
4679-1-G-T1  
4680-1-G-T1  
4670-1-G-T1  
4677-1-G-T1

-----

M10 x 15mm

M12 x 20mm

Ø11 x 22mm

Ø10 x 22mm

42 x 42mm Plate

55 x 55mm Plate

80

86.5

86.5

83.5

83.5

88.5

91

-

15

20

22

22

-

-

### GRX7536TL GOLD



### NO.

4500-1-GM-T1  
4502-1-GM-T1  
4536-1-GM-T1  
4503-1-GM-T1  
4508-1-GM-T1  
4551-1-GM-T1  
4509-1-GM-T1

-----

M10 x 15mm

M12 x 20mm

Ø11 x 22mm

Ø10 x 22mm

42 x 42mm Plate

55 x 55mm Plate

80

86.5

86.5

83.5

83.5

88.5

91

-

15

20

22

22

-

-

### GRX7536 MATT GOLD



### NO.

4600-1-GM-T1  
4671-1-GM-T1  
4673-1-GM-T1  
4679-1-GM-T1  
4680-1-GM-T1  
4670-1-GM-T1  
4677-1-GM-T1

-----

M10 x 15mm

M12 x 20mm

Ø11 x 22mm

Ø10 x 22mm

42 x 42mm Plate

55 x 55mm Plate

80

86.5

86.5

83.5

83.5

88.5

91

-

15

20

22

22

-

-

### GRX7536TL MATT GOLD



M10 x 15mm



M12 x 20mm



Ø 11 x 22mm



Ø 10 x 22mm



42 x 42mm Plate

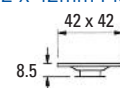

55 x 55mm Plate

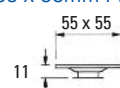

## INTRODUCTION

The GRX100 range of castors has a nominal wheel diameter of 100mm, and a load capacity of 100 kgs per castor. The GRX100 range is available as either a freewheel swivel castor or a total lock (simultaneously the swivel and wheels are braked) castor.

Total lock dramatically reduces the problem of unexpected swivel movement associated with simple wheel braking castors. The overall effect is the unit to which the castors are fitted feels far more rigid when total lock castors are used.

Additionally the GRX 100 range of castors are available with optional ball bearing races fitted to both the swivel pin and the axle. This reduces the swivel and rolling friction thereby improving mobility, bearing variants are coded GRX100B and GRX100BTL respectively.

All castors are offered with a long life polyurethane tyre as standard.

Die GRX100 Rollen haben einen Raddurchmesser von 100mm und eine Lastfähigkeit von 100kg pro Rolle. Sie ist entweder freilaufend oder mit einem Totalfeststeller erhältlich welcher das Drehen der Räder und die Schwenkung des Stiftes bremst. Der Totalfeststeller verhindert unerwartete Bewegungen die bei einfachen rad-gebremsten Rollen auftreten können. Dies bedeutet, mehr Stabilität für Ihre Produkte. Die GRX100 Rollen sind auch mit einem Kugellager an der Achse und der Befestigung erhältlich. Dies verbessert die Schwenk- und Rolleigenschaften und dadurch auch die Mobilität. Diese sind als GRX100B und GRX100BTL gekennzeichnet. Die GRX100 Rolle besitzt standardmäßig eine hochwertige und langlebige Polyurethan Lauffläche.

## INTRODUCTION

Les roulettes de la gamme GRX100 ont des roues de diamètre 100mm, et supportent une charge de 100 kgs par roulette. La GRX100 est disponible en modèle non freiné ou blocage total (blocage des roues et de la fixation). Le blocage total réduit considérablement le problème associé aux roulettes avec un simple frein à pied, qui continuent à pivoter après l'engagement du frein. L'avantage du blocage total est l'assurance d'une meilleure stabilité du meuble sur lequel la roulette est montée. De plus, les roulettes de la gamme GRX100 sont disponibles avec des roulements à billes optionnels, qui sont montés sur la fixation pivotante et aussi sur l'axe. Ceci réduit la friction du pivotement et de la rotation et améliore ainsi la mobilité. Les versions avec roulements à billes s'appellent GRX100B et GRX100BTL. Toutes les roulettes sont équipées de bandes souples en polyuréthane garantissant une grande longévité.

## INTRODUCCION

Las ruedas de la gama GRX100 tienen ruedas de diámetro 100mm, y una capacidad de carga de 100 kgs por rueda. La GRX100 está disponible como modelo sin freno o traba total (traba las ruedas y la fijación). La traba total reduce considerablemente el problema de ruedas que continúan girando cuando el freno es embragado. La ventaja de la traba total es la mejora solidez del producto para lo cual la rueda es utilizada. Además, las ruedas de la gama GRX100 están disponibles con cojinetes de bolas opcionales, que son montadas en la fijación giratoria y en el eje. Esto reduce la fricción de girar y de rodar y de ese modo mejora la movilidad. Los modelos con cojinetes de bolas se llaman GRX100B y GRX100BTL. Todas estas ruedas tienen una rodadura blanda en poliuretano durable como estandar.

## EINFÜHRUNG

### FEATURES

- GRX Design
- Optional swivel and axle bearing races
- Patented dust/grease shield
- Polyamide housing
- Polyamide mechanism
- Solid riveted axle zinc plated
- Polyamide soft tyre hub
- Polyurethane soft tyre

### EIGENSCHAFTEN:

- GRX Design
- Option mit oder ohne Kugellager an Achse und Befestigung
- Patentierter Achschenschutz
- Polyamid Gehäuse
- Polyamid Mechanik
- Stabile vernietete und verzinkte Achse
- Polyamid Rad
- Polyurethan Lauffläche

### CARACTERISTIQUES

- Design GRX
- Des roulements à billes pour le pivotement et l'axe (optionnels)
- Capot de protection de l'axe contre la poussière - breveté
- Capot en polyamide
- Mécanisme en polyamide
- Roues rivetées sur l'axe zinguée
- Roues en polyamide
- Bandes souples en polyuréthane

### ELEMENTOS

- Diseño GRX
- Cojinetes de bolas opcionales en la fijación giratoria y en el eje
- Protector del eje contra el polvo (patentado)
- Producto de PA (Nilón)
- Mecanismo de PA (Nilón)
- Ruedas remachadas en el eje chapado de zinc
- Ruedas de PA (Nilón)
- Rodadura blanda de poliuretano

### APPLICATIONS

- Medical equipment
- Home care furniture
- Office furniture
- Industrial chairs
- Domestic furniture
- Beds
- TV / video / audio stands
- Shop and display
- Equipment

### ANWENDUNGEN:

- Medizinische Geräte
- Pflegemöbiliar
- Mobile Büromöbel
- Industrie Stühle
- Im Wohnbereich
- Betten
- TV/Video/Hi-Fi Schänke
- Ladenbau
- Mobile Geräte

### APPLICATIONS

- Equipement médical
- Mobilier HAD-MAD
- Meubles de bureau
- Sièges de travail
- Meubles domestiques
- Lits
- Meubles de TV / video / hi-fi
- Aménagement de magasins
- Autre équipement

### USOS

- Equipo medico
- Mobiliario para asistencia domestica
- Mueble de oficina
- Sillas de trabajo
- Muebles domesticos
- Camas
- Muebles para TV / video / equipo de alta fidelidad
- Equipo de tiendas
- Otro equipo

### FITTINGS

Guy-Raymond manufactures a wide range of standard fittings. The GRX100 range is available with threaded stems and plate fixings. In addition Guy-Raymond can design and develop special fixings to customer requirement.

### BEFESTIGUNGEN:

Guy-Raymond bietet auch hier viele verschiedene Befestigungsmöglichkeiten. Die Rolle GRX100 ist mit Gewinde und Anschraubplatten erhältlich. Zusätzlich haben wir die Möglichkeit mit Ihnen eine Sonderfixierung zu entwickeln

### FIXATIONS

Guy-Raymond fabrique une gamme étendue de fixations standard. La gamme GRX100 est disponible avec des tiges filetées et des platines. De plus Guy-Raymond peut créer et développer des fixations spéciales pour correspondre aux besoins du client.

### FIJACIONES

Guy-Raymond fabrica una gran gama de fijaciones estándar. La gama GRX está disponible con un vástago con rosca y con una platina. Además Guy-Raymond puede diseñar y desarrollar fijaciones especiales según las necesidades del cliente.

**SPECIFICATION**

**MATERIALS**

Steel BZP

**TECHNISCHE DATEN**

**MATERIAL**

Stahl Verzinkt

**SPECIFICATION**

**MATIERES**

Acier, plaqué de zinc

**ESPECIFICACION**

**MATERIALES**

Acero chapado de zinc

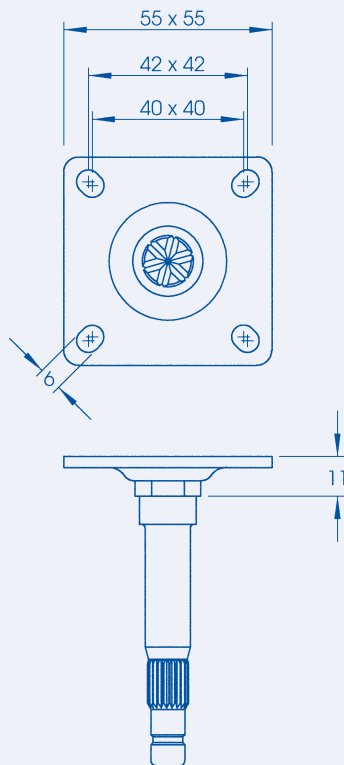

PLATE FIXING (STANDARD)  
No.19A7-9215

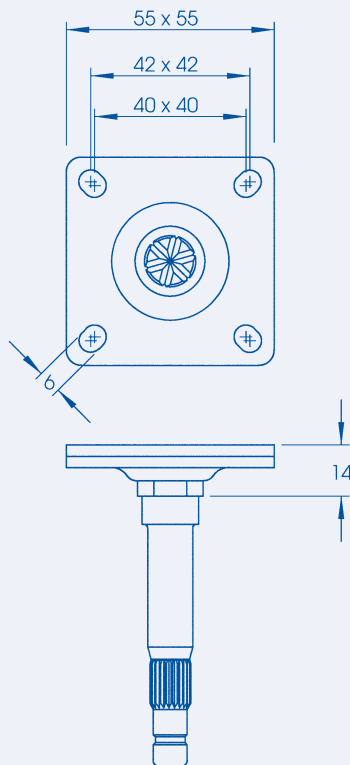
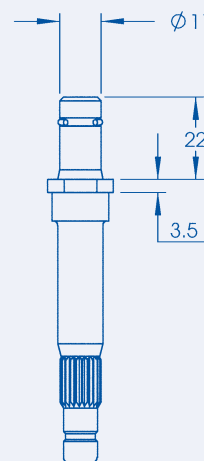
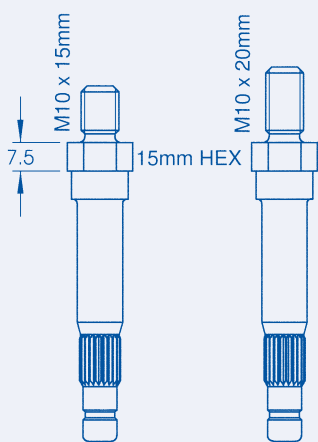

PLATE FIXING (HEAVY DUTY)  
No.19H3-9215-9203



No.19A8-T318H



M10 x 15  
No.19A1P

M10 x 20  
No.19A2P



M10 x 30  
No.19A4P

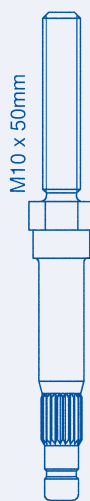

M10 x 50  
No.19C7P



M12 x 20  
No.19A3P



M12 x 30  
No.19A6P

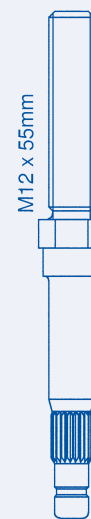

M12 x 55  
No.19C8P

# GRX100 CASTOR

## SPECIFICATION

### CASTOR TYPE

Swivel

### BEARING TYPE

Plain Bearings

### MATERIALS

Castor PA

Soft Tyre PUR

### STANDARD COLOURS

Black

Aluminium RAL 9006

Grey RAL 7035

White RAL 9003

### STANDARDS

EN 12530

## TECHNISCHE DATEN

### ROLLEN TYP

Lenkrolle

### LAGER TYP

Gleitlager

### MATERIAL

Rollen PA

Weiche Lauffläche PUR

### STANDFARBEN

Schwarz

Aluminium RAL 9006

Lichtgrau RAL 7035

Weiss RAL 9003

### NORMEN

EN 12530

## SPECIFICATION

### TYPE DE ROULETTE

Pivotante

### ROULEMENT

Alésage Lisse

### MATIERES

Roulette PA

Bandes Souples PUR

### COLORIS STANDARD

Noir

Alu RAL 9006

Gris Clair RAL 7035

Blanc RAL 9003

### NORMES

EN 12530

## ESPECIFICACION

### TIPO DE RUEDA

Giratoria

### TIPO DE COJINETE

Cojinete Liso

### MATERIALES

Rueda Nilón

Rodadura Blanda Poliuretano

### COLORES ESTANDAR

Negro

Plateado RAL 9006

Gris RAL 7035

Blanco RAL 9003

### NORMAS

EN 12530



100



113



36



10

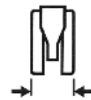

57

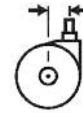

36.5



89



Up to 100kg(x)

(x) Depends on fixing



113



15

### BLACK

### NO.

6M00-1-1

6M53-1-1

6M54-1-1

6M52-1-1

6M50-1-1

6M58-1-1

-----

M10 x 15mm

M10 x 20mm

M12 x 20mm

Ø11 x 22mm

55 x 55mm Plate

### NO.

6M00-64-64-T1

6M53-64-64-T1

6M54-64-64-T1

6M52-64-64-T1

6M50-64-64-T1

6M58-64-64-T1

-----

M10 x 15mm

M10 x 20mm

M12 x 20mm

Ø11 x 22mm

55 x 55mm Plate

### ALUMINIUM - RAL 9006

### NO.

6M00-25-25

6M53-25-25

6M54-25-25

6M52-25-25

6M50-25-25

6M58-25-25

-----

M10 x 15mm

M10 x 20mm

M12 x 20mm

Ø11 x 22mm

55 x 55mm Plate

### GREY - RAL 7035

### NO.

6M00-3-3

6M53-3-3

6M54-3-3

6M52-3-3

6M50-3-3

6M58-3-3

-----

M10 x 15mm

M10 x 20mm

M12 x 20mm

Ø11 x 22mm

55 x 55mm Plate

### WHITE - RAL 9003

M10 x 15mm

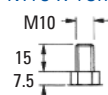

M10 x 20mm

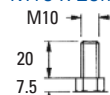

M12 x 20mm

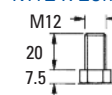

Ø11 x 22mm

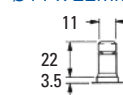

55 x 55mm Plate

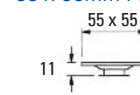

## SPECIFICATION

### CASTOR TYPE

Total Lock

### BEARING TYPE

Plain Bearings

### MATERIALS

Castor PA

Soft Tyre PUR

### STANDARD COLOURS

Black

Aluminium RAL 9006

Grey RAL 7035

White RAL 9003

### STANDARDS

EN 12530

## TECHNISCHE DATEN

### ROLLEN TYP

Totalfeststeller

### LAGER TYP

Gleitlager

### MATERIAL

Rollen PA

Weiche Lauffläche PUR

### STANDARDFARBEN

Schwarz

Aluminium RAL 9006

Lichtgrau RAL 7035

Weiss RAL 9003

### NORMEN

EN 12530

## SPECIFICATION

### TYPE DE ROULETTE

Blocage Total

### ROULEMENT

Aléasage Lisse

### MATIERES

Roulette PA

Bandes Souples PUR

### COLORIS STANDARD

Noir

Alu RAL 9006

Gris Clair RAL 7035

Blanc RAL 9003

### NORMES

EN 12530

## ESPECIFICACION

### TIPO DE RUEDA

Traba Total

### TIPO DE COJINETE

Cojinete Liso

### MATERIALES

Rueda Nilón

Rodadura Blanda Poliuretano

### COLORES ESTANDAR

Negro

Plateado RAL 9006

Gris RAL 7035

Blanco RAL 9003

### NORMAS

EN 12530



100



113



36



10



57

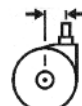

36.5



111



Up to 100kg(x)

(x) Depends on fixing



### NO.

6N00-1-1

6N53-1-1

6N54-1-1

6N52-1-1

6N50-1-1

6N58-1-1

-----

M10 x 15mm

M10 x 20mm

M12 x 20mm

Ø11 x 22mm

55 x 55mm Plate

113

121

121

121

116.5

124

-

15

20

20

22

-

### BLACK



### NO.

6N00-64-64-T1

6N53-64-64-T1

6N54-64-64-T1

6N52-64-64-T1

6N50-64-64-T1

6N58-64-64-T1

-----

M10 x 15mm

M10 x 20mm

M12 x 20mm

Ø11 x 22mm

55 x 55mm Plate

113

121

121

121

116.5

124

-

15

20

20

22

-

### ALUMINIUM - RAL 9006



### NO.

6N00-25-25

6N53-25-25

6N54-25-25

6N52-25-25

6N50-25-25

6N58-25-25

-----

M10 x 15mm

M10 x 20mm

M12 x 20mm

Ø11 x 22mm

55 x 55mm Plate

113

121

121

121

116.5

124

-

15

20

20

22

-

### GREY - RAL 7035



### NO.

6N00-3-3

6N53-3-3

6N54-3-3

6N52-3-3

6N50-3-3

6N58-3-3

-----

M10 x 15mm

M10 x 20mm

M12 x 20mm

Ø11 x 22mm

55 x 55mm Plate

113

121

121

121

116.5

124

-

15

20

20

22

-

### WHITE - RAL 9003



M10 x 15mm

M10 x 20mm

M12 x 20mm

Ø11 x 22mm

55 x 55mm Plate

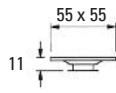
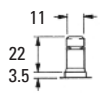
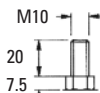



# GRX100 CONDUCTIVE CASTOR

## SPECIFICATION

### CASTOR TYPE

Swivel  
Conductive <100,000Ω

### BEARING TYPE

Plain Bearings

### MATERIALS

Castor PA  
Soft Tyre PUR

### STANDARD COLOURS

Black

Grey

### STANDARDS

EN 12530

## TECHNISCHE DATEN

### ROLLEN TYP

Lenkrolle  
Leitfähig <100,000Ω

### LAGER TYP

Gleitlager

### MATERIAL

Rolle PA  
Weiche Lauffläche PUR

### STANDARDFARBEN

Schwarz

Grau

### NORMEN

EN 12530

## SPECIFICATION

### TYPE DE ROULETTE

Pivotante  
Antistatique <100,000Ω

### ROULEMENT

Alésage Lisse

### MATIERES

Roulette PA  
Bandes Souples PUR

### COLORIS STANDARD

Noir

Gris

### NORMES

EN 12530

## ESPECIFICACION

### TIPO DE RUEDA

Giratorio  
Antiestática <100,000Ω

### TIPO DE COJINETE

Cojinete liso

### MATERIALES

Rueda Nilón  
Rodadura Blanda Poliuretano

### COLORES ESTANDAR

Negro

Gris

### NORMAS

EN 12530



100



113



36



10



57

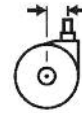

36.5



89



Up to 100kg(x)  
(x) Depends on fixing

### NO.

6M00-1-1-T2C  
6M53-1-1-T2C  
6M54-1-1-T2C  
6M52-1-1-T2C  
6M50-1-1-T2C  
6M58-1-1-T2C



-----  
M10 x 15mm  
M10 x 20mm  
M12 x 20mm  
Ø11 x 22mm  
55 x 55mm Plate



113  
121  
121  
121  
116.5  
124



-  
15  
20  
20  
22  
-

### BLACK



### NO.

6M00-25-73-T2C  
6M53-25-73-T2C  
6M54-25-73-T2C  
6M52-25-73-T2C  
6M50-25-73-T2C  
6M58-25-73-T2C

-----  
M10 x 15mm  
M10 x 20mm  
M12 x 20mm  
Ø11 x 22mm  
55 x 55mm Plate

113  
121  
121  
121  
116.5  
124

-  
15  
20  
20  
22  
-

### GREY



M10 x 15mm

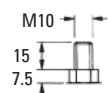

M10 x 20mm

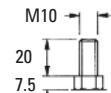

M12 x 20mm



Ø11 x 22mm

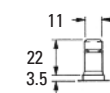

55 x 55mm Plate

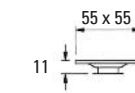

# GRX100TL CONDUCTIVE TOTAL LOCK CASTOR

## SPECIFICATION

### CASTOR TYPE

Total Lock  
Conductive <100,000Ω

### BEARING TYPE

Plain Bearings

### MATERIALS

Castor PA  
Soft Tyre PUR

### STANDARD COLOURS

Black  
Grey

### STANDARDS

EN 12530

## TECHNISCHE DATEN

### ROLLEN TYP

Totalfeststeller  
Leitfähig <100,000Ω

### LAGER TYP

Gleitlager

### MATERIAL

Rolle PA  
Weiche Lauffläche PUR

### STANDARDFARBEN

Schwarz  
Grau

### NORMEN

EN 12530

## SPECIFICATION

### TYPE DE ROULETTE

Blocage Total  
Antistatique <100,000Ω

### ROULEMENT

Alésage Lisse

### MATIERES

Roulette PA  
Bandes Souples PUR

### COLORIS STANDARD

Noir  
Gris

### NORMES

EN 12530

## ESPECIFICACION

### TIPO DE RUEDA

Freno Total  
Antiestática <100,000Ω

### TIPO DE COJINETE

Cojinete liso

### MATERIALES

Rueda Nilón  
Rodadura Blanda Poliuretano

### COLORES ESTANDAR

Negro  
Gris

### NORMAS

EN 12530



100



113



36



10

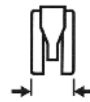

57



36.5



111



Up to 100kg(x)

(x) Depends on fixing



### NO.

6N00-1-1-T2C  
6N53-1-1-T2C  
6N54-1-1-T2C  
6N52-1-1-T2C  
6N50-1-1-T2C  
6N58-1-1-T2C

-----  
M10 x 15mm  
M10 x 20mm  
M12 x 20mm  
Ø11 x 22mm  
55 x 55mm Plate

113  
121  
121  
121  
116.5  
124

-  
15  
20  
20  
22  
-

### BLACK



### NO.

6N00-25-73-T2C  
6N53-25-73-T2C  
6N54-25-73-T2C  
6N52-25-73-T2C  
6N50-25-73-T2C  
6N58-25-73-T2C

-----  
M10 x 15mm  
M10 x 20mm  
M12 x 20mm  
Ø11 x 22mm  
55 x 55mm Plate

113  
121  
121  
121  
116.5  
124

-  
15  
20  
20  
22  
-

### GREY



M10 x 15mm



M10 x 20mm

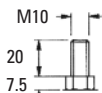

M12 x 20mm



Ø11 x 22mm

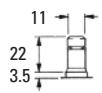

55 x 55mm Plate

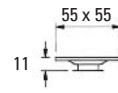

# GRX100B BEARING CASTOR

## SPECIFICATION

### CASTOR TYPE

Swivel

### BEARING TYPE

Ball Bearings

### MATERIALS

Castor PA

Soft Tyre PUR

### STANDARD COLOURS

Black

Aluminium RAL 9006

Grey RAL 7035

White RAL 9003

### STANDARDS

EN 12530

## TECHNISCHE DATEN

### ROLLEN TYP

Lenkrolle

### LAGER TYP

Kugellager

### MATERIAL

Rollen PA

Weiche Lauffläche PUR

### STANDARDFARBEN

Schwarz

Aluminium RAL 9006

Lichtgrau RAL 7035

Weiss RAL 9003

### NORMEN

EN 12530

## SPECIFICATION

### TYPE DE ROULETTE

Pivotante

### ROULEMENT

Roulement à Billes

### MATIERES

Roulette PA

Bandes Souples PUR

### COLORIS STANDARD

Noir

Alu RAL 9006

Gris Clair RAL 7035

Blanc RAL 9003

### NORMES

EN 12530

## ESPECIFICACION

### TIPO DE RUEDA

Giratoria

### TIPO DE COJINETE

Cojinete de Bolas

### MATERIALES

Rueda Nilón

Rodadura Blanda Poliuretano

### COLORES ESTANDAR

Negro

Plateado RAL 9006

Gris RAL 7035

Blanco RAL 9003

### NORMAS

EN 12530



100



113



36



10

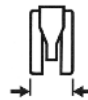

57

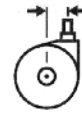

36.5



89



Up to 100kg(x)  
(x) Depends on fixing



### NO.

6P00-1-1

6P53-1-1

6P54-1-1

6P52-1-1

6P50-1-1

6P58-1-1

-----

M10 x 15mm

M10 x 20mm

M12 x 20mm

Ø11 x 22mm

55 x 55mm Plate

113

121

121

121

116.5

124

-

15

20

20

22

-

### BLACK

### NO.

6P00-64-64-T1

6P53-64-64-T1

6P54-64-64-T1

6P52-64-64-T1

6P50-64-64-T1

6P58-64-64-T1

-----

M10 x 15mm

M10 x 20mm

M12 x 20mm

Ø11 x 22mm

55 x 55mm Plate

113

121

121

121

116.5

124

-

15

20

20

22

-

### ALUMINIUM - RAL 9006

### NO.

6P00-25-25

6P53-25-25

6P54-25-25

6P52-25-25

6P50-25-25

6P58-25-25

-----

M10 x 15mm

M10 x 20mm

M12 x 20mm

Ø11 x 22mm

55 x 55mm Plate

113

121

121

121

116.5

124

-

15

20

20

22

-

### GREY - RAL 7035

### NO.

6P00-3-3

6P53-3-3

6P54-3-3

6P52-3-3

6P50-3-3

6P58-3-3

-----

M10 x 15mm

M10 x 20mm

M12 x 20mm

Ø11 x 22mm

55 x 55mm Plate

113

121

121

121

116.5

124

-

15

20

20

22

-

### WHITE - RAL 9003

M10 x 15mm

M10 x 20mm

M12 x 20mm

Ø11 x 22mm

55 x 55mm Plate

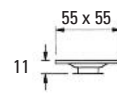
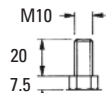
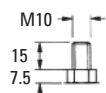

# GRX100BTL BEARING TOTAL LOCK CASTOR

## SPECIFICATION

### CASTOR TYPE

Total Lock

### BEARING TYPE

Ball Bearings

Castor PA

Soft Tyre PUR

### MATERIALS

Castor PA

Soft Tyre PUR

### STANDARD COLOURS

Black

Aluminium RAL 9006

Grey RAL 7035

White RAL 9003

### STANDARDS

EN 12530

## TECHNISCHE DATEN

### ROLLEN TYP

Totalfeststeller

### LAGER TYP

Kugellager

### MATERIAL

Rollen PA

Weiche Lauffläche PUR

### STANDARDFARBEN

Schwarz

Aluminium RAL 9006

Lichtgrau RAL 7035

Weiss RAL 9003

### NORMEN

EN 12530

## SPECIFICATION

### TYPE DE ROULETTE

Blocage Total

### ROULEMENT

Roulement à Billes

### MATIERES

Roulette PA

Bandes Souples PUR

### COLORIS STANDARD

Noir

Alu RAL 9006

Gris Clair RAL 7035

Blanc RAL 9003

### NORMES

EN 12530

## ESPECIFICACION

### TIPO DE RUEDA

Traba Total

### TIPO DE COJINETE

Cojinete de Bolas

### MATERIALES

Rueda Nilón

Rodadura Blanda Poliuretano

### COLORES ESTANDAR

Negro

Plateado RAL 9006

Gris RAL 7035

Blanco RAL 9003

### NORMAS

EN 12530



100



113



36



10



57



36.5



111



Up to 100kg(x)  
(x) Depends on fixing



### NO.

6R00-1-1

6R53-1-1

6R54-1-1

6R52-1-1

6R50-1-1

6R58-1-1

-----  
M10 x 15mm  
M10 x 20mm  
M12 x 20mm  
Ø11 x 22mm  
55 x 55mm Plate

113  
121  
121  
121  
116.5  
124

-  
15  
20  
20  
22  
-

### BLACK

### NO.

6R00-64-64-T1

6R53-64-64-T1

6R54-64-64-T1

6R52-64-64-T1

6R50-64-64-T1

6R58-64-64-T1

-----  
M10 x 15mm  
M10 x 20mm  
M12 x 20mm  
Ø11 x 22mm  
55 x 55mm Plate

113  
121  
121  
121  
116.5  
124

-  
15  
20  
20  
22  
-

### ALUMINIUM - RAL 9006

### NO.

6R00-25-25

6R53-25-25

6R54-25-25

6R52-25-25

6R50-25-25

6R58-25-25

-----  
M10 x 15mm  
M10 x 20mm  
M12 x 20mm  
Ø11 x 22mm  
55 x 55mm Plate

113  
121  
121  
121  
116.5  
124

-  
15  
20  
20  
22  
-

### GREY - RAL 7035

### NO.

6R00-3-3

6R53-3-3

6R54-3-3

6R52-3-3

6R50-3-3

6R58-3-3

-----  
M10 x 15mm  
M10 x 20mm  
M12 x 20mm  
Ø11 x 22mm  
55 x 55mm Plate

113  
121  
121  
121  
116.5  
124

-  
15  
20  
20  
22  
-

### WHITE - RAL 9003

M10 x 15mm

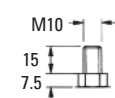

M10 x 20mm

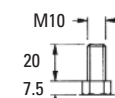

M12 x 20mm



Ø11 x 22mm



55 x 55mm Plate

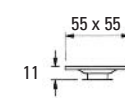

E-Mail: [info@guy-raymond.co.uk](mailto:info@guy-raymond.co.uk) Tel +44 (0)1553 761401 Fax +44 (0)1553 767459 [www.guy-raymond.com](http://www.guy-raymond.com)

© Copyright Guy-Raymond Engineering Company Limited October 2014.

We reserve the right to modify designs without prior notice.

# GRX100B CONDUCTIVE BEARING CASTOR

## SPECIFICATION

### CASTOR TYPE

Swivel  
Conductive <100,000Ω

### BEARING TYPE

Ball Bearings

### MATERIALS

Castor PA  
Soft Tyre PUR

### STANDARD COLOURS

Black  
Grey

### STANDARDS

EN 12530

## TECHNISCHE DATEN

### ROLLEN TYP

Lenkrolle  
Leitfähig <100,000Ω

### LAGER TYP

Kugellager

### MATERIAL

Rolle PA  
Weiche Lauffläche PUR

### STANDARDFARBEN

Schwarz  
Grau

### NORMEN

EN 12530

## SPECIFICATION

### TYPE DE ROULETTE

Pivotante  
Antistatique <100,000Ω

### ROULEMENT

Roulement à Billes

### MATIERES

Roulette PA  
Bandes Souples PUR

### COLORIS STANDARD

Noir  
Gris

### NORMES

EN 12530

## ESPECIFICACION

### TIPO DE RUEDA

Giratorio  
Antiestática <100,000Ω

### TIPO DE COJINETE

Cojinete de Bolas

### MATERIALES

Rueda Nilón  
Rodadura Blanda Poliuretano

### COLORES ESTANDAR

Negro  
Gris

### NORMAS

EN 12530



100



113



36



10



57

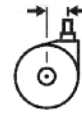

36.5



89



Up to 100kg(x)  
(x) Depends on fixing



### NO.

6P00-1-1-T2C  
6P53-1-1-T2C  
6P54-1-1-T2C  
6P52-1-1-T2C  
6P50-1-1-T2C  
6P58-1-1-T2C

-----  
M10 x 15mm  
M10 x 20mm  
M12 x 20mm  
Ø11 x 22mm  
55 x 55mm Plate

113  
121  
121  
121  
116.5  
124

-  
15  
20  
20  
22  
-

### BLACK



### NO.

6P00-25-73-T2C  
6P53-25-73-T2C  
6P54-25-73-T2C  
6P52-25-73-T2C  
6P50-25-73-T2C  
6P58-25-73-T2C

-----  
M10 x 15mm  
M10 x 20mm  
M12 x 20mm  
Ø11 x 22mm  
55 x 55mm Plate

113  
121  
121  
121  
116.5  
124

-  
15  
20  
20  
22  
-

### GREY

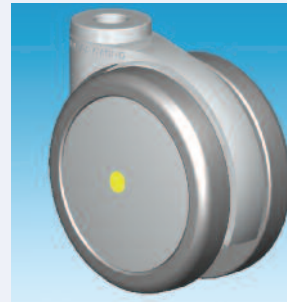

M10 x 15mm

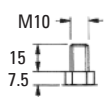

M10 x 20mm

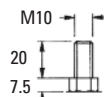

M12 x 20mm



Ø11 x 22mm

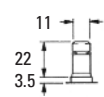

55 x 55mm Plate

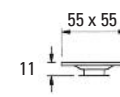

# GRX100BTL CONDUCTIVE BEARING TOTAL LOCK CASTOR

## SPECIFICATION

### CASTOR TYPE

Total Lock  
Conductive <100,000Ω

### BEARING TYPE

Ball Bearings

### MATERIALS

Castor PA  
Soft Tyre PUR

### STANDARD COLOURS

Black  
Grey

### STANDARDS

EN 12530

## TECHNISCHE DATEN

### ROLLEN TYP

Totalfeststeller  
Leitfähig <100,000Ω

### LAGER TYP

Kugellager

### MATERIAL

Rolle PA  
Weiche Lauffläche PUR

### STANDARDFARBEN

Schwarz  
Grau

### NORMEN

EN 12530

## SPECIFICATION

### TYPE DE ROULETTE

Blocage Total  
Antistatique <100,000Ω

### ROULEMENT

Roulement à Billes

### MATIERES

Roulette PA  
Bandes Souples PUR

### COLORIS STANDARD

Noir  
Gris

### NORMES

EN 12530

## ESPECIFICACION

### TIPO DE RUEDA

Traba Total  
Antiestática <100,000Ω

### TIPO DE COJINETE

Cojinete de Bolas

### MATERIALES

Rueda Nilón  
Rodadura Blanda Poliuretano

### COLORES ESTANDAR

Negro  
Gris RAL 7035

### NORMAS

EN 12530



100



113



36



10



57



36.5



111



Up to 100kg(x)  
(x) Depends on fixing

### NO.

6R00-1-1-T2C  
6R53-1-1-T2C  
6R54-1-1-T2C  
6R52-1-1-T2C  
6R50-1-1-T2C  
6R58-1-1-T2C



-----  
M10 x 15mm  
M10 x 20mm  
M12 x 20mm  
Ø11 x 22mm  
55 x 55mm Plate



113  
121  
121  
121  
116.5  
124



-  
15  
20  
20  
22  
-

### BLACK



### NO.

6R00-25-73-T2C  
6R53-25-73-T2C  
6R54-25-73-T2C  
6R52-25-73-T2C  
6R50-25-73-T2C  
6R58-25-73-T2C

-----  
M10 x 15mm  
M10 x 20mm  
M12 x 20mm  
Ø11 x 22mm  
55 x 55mm Plate

113  
121  
121  
121  
116.5  
124

-  
15  
20  
20  
22  
-

### GREY



M10 x 15mm

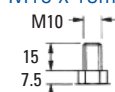

M10 x 20mm

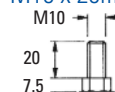

M12 x 20mm

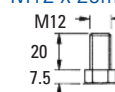

Ø11 x 22mm



55 x 55mm Plate

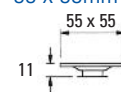



# GRX100 CHROME CASTOR & GRX100TL CHROME CASTOR

## SPECIFICATION

### CASTOR TYPE

GRX100 Swivel  
GRX100TL Total Lock

### BEARING TYPE

GRX100 Plain Bearings  
GRX100TL Plain Bearings

### MATERIALS

Castor PA  
Soft Tyre PUR  
Wheel Trim Chrome Plated ABS

### STANDARD COLOURS

Black

### STANDARDS

EN 12530

## TECHNISCHE DATEN

### ROLLEN TYP

GRX100 Lenkrolle  
GRX100TL Totalfeststeller

### LAGER TYP

GRX100 Gleitlager  
GRX100TL Gleitlager

### MATERIAL

Rolle PA  
Weiche Lauffläche PUR  
Radkappen ABS Verchromt

### STANDARDFARBEN

Schwarz

### NORMEN

EN 12530

## SPECIFICATION

### TYPE DE ROULETTE

GRX100 Pivotante  
GRX100TL Blocage Total

### ROULEMENT

GRX100 Alésage Lisse  
GRX100TL Alésage Lisse

### MATIERES

Rouleto PA  
Bandes Souples PUR  
Enjoliveurs ABS Chromé

### COLORIS STANDARD

Noir

### NORMES

EN 12530

## ESPECIFICACION

### TIPO DE RUEDA

GRX100 Giratoria  
GRX100TL Freno Total

### TIPO DE COJINETE

GRX100 Cojinete Liso  
GRX100TL Cojinete Liso

### MATERIALES

Rueda Nilón  
Rodadura Blanda Poliuretano  
Tapacubos ABS Cromado

### COLORES ESTANDAR

Negro

### NORMAS

EN 12530



100



113



36



10

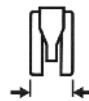

57



36.5



89 & 111



Up to 100kg(x)  
(x) Depends on fixing

### NO.

6M00-1-Z-T1  
6M53-1-Z-T1  
6M54-1-Z-T1  
6M52-1-Z-T1  
6M50-1-Z-T1  
6M58-1-Z-T1



-----  
M10 x 15mm  
M10 x 20mm  
M12 x 20mm  
Ø11 x 22mm  
55 x 55mm Plate



113  
121  
121  
121  
116.5  
124



-  
15  
20  
20  
22  
-

### GRX100 CHROME



### NO.

6N00-1-Z-T1  
6N53-1-Z-T1  
6N54-1-Z-T1  
6N52-1-Z-T1  
6N50-1-Z-T1  
6N58-1-Z-T1

-----  
M10 x 15mm  
M10 x 20mm  
M12 x 20mm  
Ø11 x 22mm  
55 x 55mm Plate

113  
121  
121  
121  
116.5  
124

-  
15  
20  
20  
22  
-

### GRX100TL CHROME

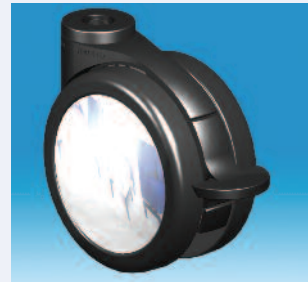

### NO.

6M00-1-ZM-T1  
6M53-1-ZM-T1  
6M54-1-ZM-T1  
6M52-1-ZM-T1  
6M50-1-ZM-T1  
6M58-1-ZM-T1

-----  
M10 x 15mm  
M10 x 20mm  
M12 x 20mm  
Ø11 x 22mm  
55 x 55mm Plate

113  
121  
121  
121  
116.5  
124

-  
15  
20  
20  
22  
-

### GRX100 MATT CHROME



### NO.

6N00-1-ZM-T1  
6N53-1-ZM-T1  
6N54-1-ZM-T1  
6N52-1-ZM-T1  
6N50-1-ZM-T1  
6N58-1-ZM-T1

-----  
M10 x 15mm  
M10 x 20mm  
M12 x 20mm  
Ø11 x 22mm  
55 x 55mm Plate

113  
121  
121  
121  
116.5  
124

-  
15  
20  
20  
22  
-

### GRX100TL MATT CHROME



M10 x 15mm

M10 x 20mm

M12 x 20mm

Ø11 x 22mm

55 x 55mm Plate

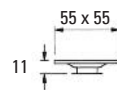
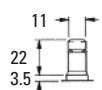
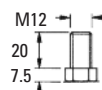
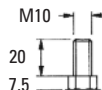
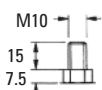

# GRX100 GOLD CASTOR & GRX100TL GOLD CASTOR

## SPECIFICATION

### CASTOR TYPE

GRX100 Swivel  
GRX100TL Total Lock

### BEARING TYPE

GRX100 Plain Bearings  
GRX100TL Plain Bearings

### MATERIALS

Castor PA  
Soft Tyre PUR  
Wheel Trim Gold Plated ABS

### STANDARD COLOURS

Black

### STANDARDS

EN 12530

## TECHNISCHE DATEN

### ROLLEN TYP

GRX100 Lenkrolle  
GRX100TL Totalfeststeller

### LAGER TYP

GRX100 Gleitlager  
GRX100TL Gleitlager

### MATERIAL

Rolle PA  
Weiche Lauffläche PUR  
Radkappen ABS Vergoldet

### STANDARDFARBEN

Schwarz

### NORMEN

EN 12530

## SPECIFICATION

### TYPE DE ROULETTE

GRX100 Pivotante  
GRX100TL Blocage Total

### ROULEMENT

GRX100 Alésage Lisse  
GRX100TL Alésage Lisse

### MATIERES

Roulette PA  
Bandes Souples PUR  
Enjoliveurs ABS Plaquage Or

### COLORIS STANDARD

Noir

### NORMES

EN 12530

## ESPECIFICACION

### TIPO DE RUEDA

GRX100 Giratoria  
GRX100TL Freno Total

### TIPO DE COJINETE

GRX100 Cojinete Liso  
GRX100TL Cojinete Liso

### MATERIALES

Rueda Nilón  
Rodadura Blanda Poliuretano  
Tapacubos ABS Chapado En Oro

### COLORES ESTANDAR

Negro

### NORMAS

EN 12530



100



113



36



10



57

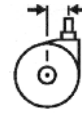

36.5



89 & 111



Up to 100kg(x)

(x) Depends on fixing

### NO.

6M00-1-G-T1  
6M53-1-G-T1  
6M54-1-G-T1  
6M52-1-G-T1  
6M50-1-G-T1  
6M58-1-G-T1



### GRX100 GOLD

-----  
M10 x 15mm  
M10 x 20mm  
M12 x 20mm  
Ø11 x 22mm  
55 x 55mm Plate

113  
121  
121  
121  
116.5  
124

-  
15  
20  
20  
22  
-



### NO.

6N00-1-G-T1  
6N53-1-G-T1  
6N54-1-G-T1  
6N52-1-G-T1  
6N50-1-G-T1  
6N58-1-G-T1

-----  
M10 x 15mm  
M10 x 20mm  
M12 x 20mm  
Ø11 x 22mm  
55 x 55mm Plate

113  
121  
121  
121  
116.5  
124

-  
15  
20  
20  
22  
-

### GRX100TL GOLD



### NO.

6M00-1-GM-T1  
6M53-1-GM-T1  
6M54-1-GM-T1  
6M52-1-GM-T1  
6M50-1-GM-T1  
6M58-1-GM-T1

-----  
M10 x 15mm  
M10 x 20mm  
M12 x 20mm  
Ø11 x 22mm  
55 x 55mm Plate

113  
121  
121  
121  
116.5  
124

-  
15  
20  
20  
22  
-

### GRX100 MATT GOLD



### NO.

6N00-1-GM-T1  
6N53-1-GM-T1  
6N54-1-GM-T1  
6N52-1-GM-T1  
6N50-1-GM-T1  
6N58-1-GM-T1

-----  
M10 x 15mm  
M10 x 20mm  
M12 x 20mm  
Ø11 x 22mm  
55 x 55mm Plate

113  
121  
121  
121  
116.5  
124

-  
15  
20  
20  
22  
-

### GRX100TL MATT GOLD



M10 x 15mm

M10 x 20mm

M12 x 20mm

Ø11 x 22mm

55 x 55mm Plate

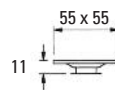
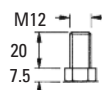
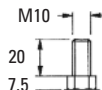
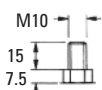

# GRX100B CHROME CASTOR & GRX100BTL CHROME CASTOR

## SPECIFICATION

### CASTOR TYPE

GRX100B Swivel  
GRX100BTL Total Lock

### BEARING TYPE

GRX100B Ball Bearings  
GRX100BTL Ball Bearings

### MATERIALS

Castor PA  
Soft Tyre PUR  
Wheel Trim Chrome Plated ABS

### STANDARD COLOURS

Black

### STANDARDS

EN 12530

## TECHNISCHE DATEN

### ROLLEN TYP

GRX100B Lenkrolle  
GRX100BTL Totalfeststeller

### LAGER TYP

GRX100B Kugellager  
GRX100BTL Kugellager

### MATERIAL

Rolle PA  
Weiche Lauffläche PUR  
Radkappen ABS Verchromt

### STANDARDFARBEN

Schwarz

### NORMEN

EN 12530

## SPECIFICATION

### TYPE DE ROULETTE

GRX100B Pivotante  
GRX100BTL Blocage Total

### ROULEMENT

GRX100B Roulement à Billes  
GRX100BTL Roulement à Billes

### MATIERES

Roulette PA  
Bandes Souples PUR  
Enjoliveurs ABS Chromé

### COLORIS STANDARD

Noir

### NORMES

EN 12530

## ESPECIFICACION

### TIPO DE RUEDA

GRX100B Giratoria  
GRX100BTL Freno Total

### TIPO DE COJINETE

GRX100B Cojinete de Bolas  
GRX100BTL Cojinete de Bolas

### MATERIALES

Rueda Nilón  
Rodadura Blanda Poliuretano  
Tapacubos ABS Cromado

### COLORES ESTANDAR

Negro

### NORMAS

EN 12530



100



113



36



10



57

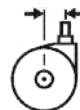

36.5



89 & 111



Up to 100kg(x)  
(x) Depends on fixing

### NO.

6P00-1-Z-T1  
6P53-1-Z-T1  
6P54-1-Z-T1  
6P52-1-Z-T1  
6P50-1-Z-T1  
6P58-1-Z-T1

-----  
M10 x 15mm  
M10 x 20mm  
M12 x 20mm  
Ø11 x 22mm  
55 x 55mm Plate

113  
121  
121  
121  
116.5  
124

-  
15  
20  
20  
22  
-

### GRX100B CHROME



### NO.

6R00-1-Z-T1  
6R53-1-Z-T1  
6R54-1-Z-T1  
6R52-1-Z-T1  
6R50-1-Z-T1  
6R58-1-Z-T1

-----  
M10 x 15mm  
M10 x 20mm  
M12 x 20mm  
Ø11 x 22mm  
55 x 55mm Plate

113  
121  
121  
121  
116.5  
124

-  
15  
20  
20  
22  
-

### GRX100BTL CHROME



### NO.

6P00-1-ZM-T1  
6P53-1-ZM-T1  
6P54-1-ZM-T1  
6P52-1-ZM-T1  
6P50-1-ZM-T1  
6P58-1-ZM-T1

-----  
M10 x 15mm  
M10 x 20mm  
M12 x 20mm  
Ø11 x 22mm  
55 x 55mm Plate

113  
121  
121  
121  
116.5  
124

-  
15  
20  
20  
22  
-

### GRX100B MATT CHROME



### NO.

6R00-1-ZM-T1  
6R53-1-ZM-T1  
6R54-1-ZM-T1  
6R52-1-ZM-T1  
6R50-1-ZM-T1  
6R58-1-ZM-T1

-----  
M10 x 15mm  
M10 x 20mm  
M12 x 20mm  
Ø11 x 22mm  
55 x 55mm Plate

113  
121  
121  
121  
116.5  
124

-  
15  
20  
20  
22  
-

### GRX100BTL MATT CHROME



M10 x 15mm

M10 x 20mm

M12 x 20mm

Ø11 x 22mm

55 x 55mm Plate

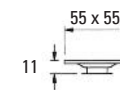
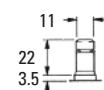
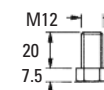
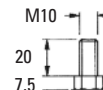

# GRX100B GOLD CASTOR & GRX100BTL GOLD CASTOR

## SPECIFICATION

### CASTOR TYPE

GRX100B Swivel  
GRX100BTL Total Lock

### BEARING TYPE

GRX100B Ball Bearings  
GRX100BTL Ball Bearings

### MATERIALS

Castor PA  
Soft Tyre PUR  
Wheel Trim Gold Plated ABS

### STANDARD COLOURS

Black

### STANDARDS

EN 12530

## TECHNISCHE DATEN

### ROLLEN TYP

GRX100B Lenkrolle  
GRX100BTL Totalfeststeller

### LAGER TYP

GRX100B Kugellager  
GRX100BTL Kugellager

### MATERIAL

Rolle PA  
Weiche Lauffläche PUR  
Radkappen ABS Vergoldet

### STANDARDFARBEN

Schwarz

### NORMEN

EN 12530

## SPECIFICATION

### TYPE DE ROULETTE

GRX100B Pivotante  
GRX100BTL Blocage Total

### ROULEMENT

GRX100B Roulement à Billes  
GRX100BTL Roulement à Billes

### MATIERES

Roulette PA  
Bandes Souples PUR  
Enjoliveurs ABS Plaquage Or

### COLORIS STANDARD

Noir

### NORMES

EN 12530

## ESPECIFICACION

### TIPO DE RUEDA

GRX100B Giratoria  
GRX100BTL Freno Total

### TIPO DE COJINETE

GRX100B Cojinete de Bolas  
GRX100BTL Cojinete de Bolas

### MATERIALES

Rueda Nilón  
Rodadura Blanda Poliuretano  
Tapacubos ABS Chapado En Oro

### COLORES ESTANDAR

Negro

### NORMAS

EN 12530



100



113



36



10

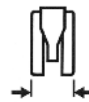

57



36.5



89 & 111



Up to 100kg(x)  
(x) Depends on fixing

### NO.

6P00-1-G-T1	-----	113	-
6P53-1-G-T1	M10 x 15mm	121	15
6P54-1-G-T1	M10 x 20mm	121	20
6P52-1-G-T1	M12 x 20mm	121	20
6P50-1-G-T1	Ø11 x 22mm	116.5	22
6P58-1-G-T1	55 x 55mm Plate	124	-

### GRX100B GOLD



### NO.

6R00-1-G-T1	-----	113	-
6R53-1-G-T1	M10 x 15mm	121	15
6R54-1-G-T1	M10 x 20mm	121	20
6R52-1-G-T1	M12 x 20mm	121	20
6R50-1-G-T1	Ø11 x 22mm	116.5	22
6R58-1-G-T1	55 x 55mm Plate	124	-

### GRX100BTL GOLD



### NO.

6P00-1-GM-T1	-----	113	-
6P53-1-GM-T1	M10 x 15mm	121	15
6P54-1-GM-T1	M10 x 20mm	121	20
6P52-1-GM-T1	M12 x 20mm	121	20
6P50-1-GM-T1	Ø11 x 22mm	116.5	22
6P58-1-GM-T1	55 x 55mm Plate	124	-

### GRX100B MATT GOLD



### NO.

6R00-1-GM-T1	-----	113	-
6R53-1-GM-T1	M10 x 15mm	121	15
6R54-1-GM-T1	M10 x 20mm	121	20
6R52-1-GM-T1	M12 x 20mm	121	20
6R50-1-GM-T1	Ø11 x 22mm	116.5	22
6R58-1-GM-T1	55 x 55mm Plate	124	-

### GRX100BTL MATT GOLD



M10 x 15mm

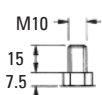

M10 x 20mm

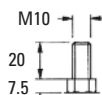

M12 x 20mm

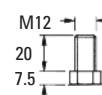

Ø11 x 22mm



55 x 55 mm Plate



## INTRODUCTION

The GRX125 range of castors has a nominal wheel diameter of 125mm, and a load capacity of up to 100 kgs per castor. The GRX125 range is available as a either a free wheeling swivel castor or a total locking (simultaneously the swivel and wheels are braked) castor. Total locking dramatically reduces the problem of unexpected swivel movement associated with simple wheel braking castors. The overall effect is the unit to which the castors are fitted feels far more rigid when total lock castors are used. Additionally the GRX125 range of castors are available as standard with ball bearings races fitted to both the swivel pin and the axle. This reduces the swivel and rolling friction thereby improving mobility. All castors are offered with a long life polyurethane tyre as standard.

## EINFÜHRUNG

Die GRX125 Rolle hat einen Raddurchmesser von 125mm und eine Lastfähigkeit von 100kg pro Rolle. Sie ist entweder freilaufend oder mit einem Totalfeststeller erhältlich, welcher der Drehen der Räder und das Schwenken des Stiftes verhindert. Der Totalfeststeller verhindert unerwartete Bewegungen die bei einfachen rad-gebremsten Rollen auftreten können. Dies bedeutet mehr Stabilität für Ihre Produkte. Die GRX125 Rolle ist standardmäßig mit einem Kugellager an der Achse und an dem Stift ausgestattet. Dies verbessert die Schwenk- und Rolleigenschaften und dadurch auch die Mobilität. Weiterhin besitzt die Rolle eine hochwertige und langlebige Polyurethan Lauffläche.

## INTRODUCTION

Les roulettes de la gamme GRX125 ont des roues de diamètre 125mm, et supportent une charge de 100kg par roulette. La GRX125 est disponible en modèle non freiné ou blocage total (blocage des roues et de la fixation). Le blocage total réduit considérablement le problème associé aux roulettes avec un simple frein à pied, qui continuent à pivoter après l'engagement du frein. L'avantage du blocage total est l'assurance d'une meilleure stabilité du produit sur lequel la roulette est montée. De plus, toutes les roulettes GRX125 sont équipées de roulements à billes qui sont montés sur la fixation pivotante et aussi sur l'axe. Ceci réduit la friction du pivotement et de la rotation et améliore ainsi la mobilité. Toutes les roulettes sont équipées de bandes souples en polyuréthane garantissant une grande longévité.

## INTRODUCCION

Las ruedas de la gama GRX125 tienen ruedas de diámetro 125mm, y una capacidad de carga de 100kg por rueda. La GRX125 está disponible como modelo sin freno o traba total (traba las ruedas y la fijación). La traba total reduce considerablemente el problema de ruedas que continúan girando cuando el freno es embragado. La ventaja de la traba total es la mejora solidez del producto para lo cual la rueda es utilizada. Además, las ruedas de la gama GRX125 tienen cojinetes de bolas montados en la fijación giratoria y en el eje. Esto reduce la fricción de girar y de rodar y de este modo mejora la movilidad. Todas estas ruedas tienen una rodadura blanda en poliuretano durable como estándar.

## FEATURES

- GRX Design
- Swivel and axle bearing races
- Patented grease shield
- Polyamide housing
- Polyamide mechanism
- Solid riveted axle zinc plated
- Polyamide soft tyre hub
- Polyurethane soft tyre

## EIGENSCHAFTEN:

- GRX Design
- Kugellager an Achse und Befestigung
- Patentierter Achsenschutz
- Polyamid Gehäuse
- Polyamid Mechanik
- Stabile vernietete und verzinkte Achse
- Polyamid Rad
- Polyurethan Lauffläche

## CARACTERISTIQUES

- Design GRX
- Des roulements à billes pour le pivotement et l'axe
- Capot de protection de l'axe contre la poussière (breveté)
- Capot en polyamide
- Mécanisme en polyamide
- Roues rivetées sur l'axe zinguée
- Roues en polyamide
- Bandes souples en polyurethane

## ELEMENTOS

- Diseño GRX
- Cojinetes de bolas en la fijación giratoria y en el eje
- Protector del eje contra el polvo (patentado)
- Producto de PA (Nilón)
- Mecanismo de PA (Nilón)
- Ruedas remachadas en el eje chapado de zinc
- Ruedas de PA (Nilón)
- Rodadura blanda de poliuretano

## APPLICATIONS

- Medical Equipment
- Home care furniture
- Office furniture
- Beds
- TV / video / audio stands
- Shop and display
- Equipment

## ANWENDUNGEN:

- Medizinische Geräte
- Pflegemöbiliar
- Mobile Büromöbel
- Betten
- TV / Video / HiFi Schränke
- Ladenbau
- Mobile Geräte

## APPLICATIONS

- Equipement médical
- Mobilier HAD-MAD
- Meubles de bureau
- Lits
- Meubles de TV / video / hi-fi
- Aménagement de magasins
- Autre équipement

## USOS

- Equipo médico
- Mobiliario para asistencia doméstica
- Mueble de oficina
- Camas
- Muebles para TV / video / equipo de alta fidelidad
- Equipo de tiendas
- Otro equipo

## FITTINGS

Guy-Raymond manufactures a wide range of standard fittings. The GRX125 range is available with various stems and plate fixings. In addition Guy-Raymond can design and develop special fixings to customer requirement.

## BEFESTIGUNGEN:

Guy-Raymond bietet viele verschiedene Befestigungsmöglichkeiten. Gewindestifte und Anschraubplatten sind Standard. Zusätzlich besteht die Möglichkeit mit Ihnen eine Sonderfixierung zu entwickeln.

## FIXATIONS

Guy-Raymond fabrique une gamme étendue de fixations standard. La gamme GRX125 est disponible avec plusieurs tiges et platines. De plus Guy-Raymond peut créer et développer des fixations spéciales pour correspondre aux besoins du client.

## FIJACIONES

Guy-Raymond fabrica una gran gama de fijaciones estándar. La gama GRX está disponible con varios vástagos y platinas. Además Guy-Raymond puede diseñar y desarrollar fijaciones especiales según las necesidades del cliente.

## SPECIFICATION MATERIALS

Steel BZP

## TECHNISCHE DATEN MATERIAL

Stahl Verzinkt

## SPECIFICATION MATIERES

Acier, plaqué de zinc

## ESPECIFICACION MATERIALES

Acero chapado de zinc

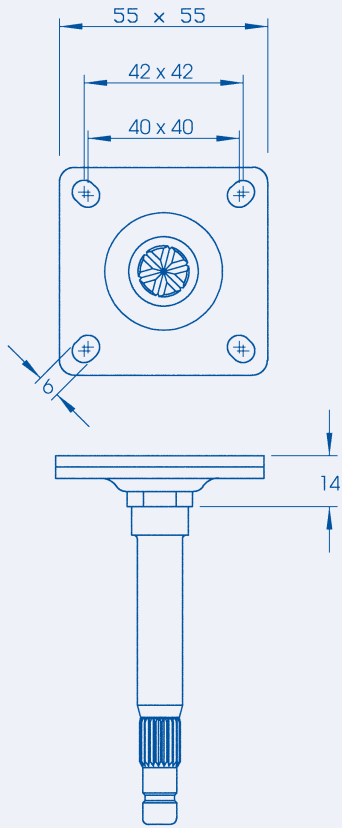
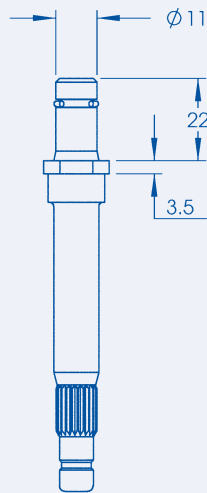
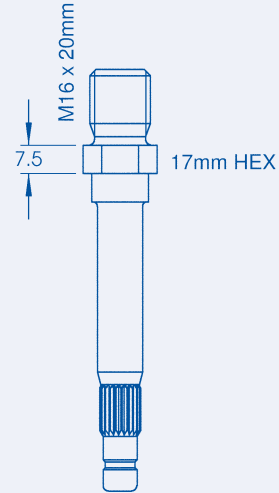

PLATE FIXING  
No.19C4-9215-9203



No.19C3-T318H



M16 x 20  
No.19G5P

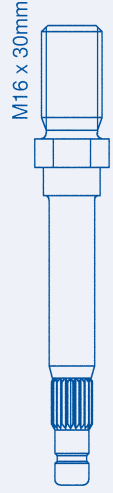

M16 x 30  
No.19G6P

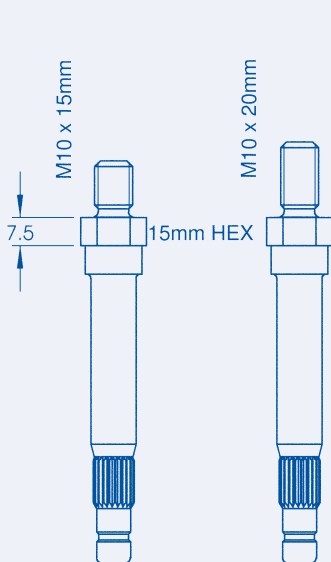

M10 x 15  
No.19C0P

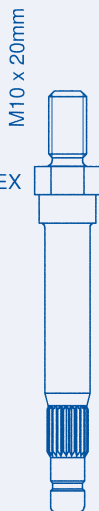

M10 x 20  
No.19C1P

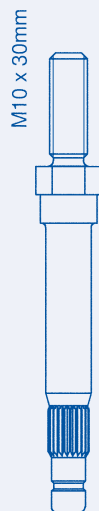

M10 x 30  
No.19H0P

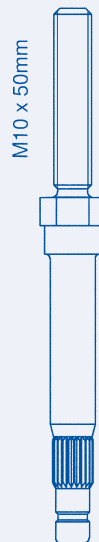

M10 x 50  
No.19C9P



M12 x 20  
No.19C2P



M12 x 30  
No.19D3P

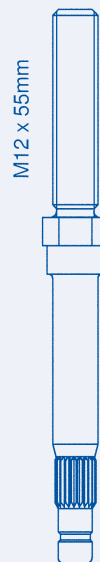

M12 x 55  
No.19D0P



# GRX125B BEARING CASTOR

## SPECIFICATION

### CASTOR TYPE

Swivel

### BEARING TYPE

Ball Bearings

### MATERIALS

Castor PA

Soft Tyre PUR

### STANDARD COLOURS

Black

Aluminium RAL 9006

Grey RAL 7035

White RAL 9003

### STANDARDS

EN 12530

## TECHNISCHE DATEN

### ROLLEN TYP

Lenkrolle

### LAGER TYP

Kugellager

### MATERIAL

Rollen PA

Weiche Lauffläche PUR

### STANDARDFARBEN

Schwarz

Aluminium RAL 9006

Lichtgrau RAL 7035

Weiss RAL 9003

### NORMEN

EN 12530

## SPECIFICATION

### TYPE DE ROULETTE

Pivotante

### ROULEMENT

Roulement à Billes

### MATIERES

Roulette PA

Bandes Souples PUR

### COLORIS STANDARD

Noir

Alu RAL 9006

Gris Clair RAL 7035

Blanc RAL 9003

### NORMES

EN 12530

## ESPECIFICACION

### TIPO DE RUEDA

Giratoria

### TIPO DE COJINETE

Cojinete de Bolas

### MATERIALES

Ruota PA

Rodadura Blanda Poliuretano

### COLORES ESTANDAR

Negro

Plateado RAL 9006

Gris RAL 7035

Blanco RAL 9003

### NORMAS

EN 12530



125



139



48



11



67

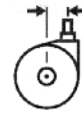

43



109



Up to 100kg(x)  
(x) Depends on fixing



### NO.

6T00-1-1

6TB0-1-1

6TC0-1-1

6TA0-1-1

6TD0-1-1

6TE0-1-1

-----

M10 x 15mm

M10 x 20mm

M12 x 20mm

Ø11 x 22mm

55 x 55mm Plate

139

146.5

146.5

146.5

142.5

153

-

15

20

20

22

-

### BLACK



### NO.

6T00-64-64-T1

6TB0-64-64-T1

6TC0-64-64-T1

6TA0-64-64-T1

6TD0-64-64-T1

6TE0-64-64-T1

-----

M10 x 15mm

M10 x 20mm

M12 x 20mm

Ø11 x 22mm

55 x 55mm Plate

139

146.5

146.5

146.5

142.5

153

-

15

20

20

22

-

### ALUMINIUM - RAL 9006



### NO.

6T00-25-25

6TB0-25-25

6TC0-25-25

6TA0-25-25

6TD0-25-25

6TE0-25-25

-----

M10 x 15mm

M10 x 20mm

M12 x 20mm

Ø11 x 22mm

55 x 55mm Plate

139

146.5

146.5

146.5

142.5

153

-

15

20

20

22

-

### GREY - RAL 7035



### NO.

6T00-3-3

6TB0-3-3

6TC0-3-3

6TA0-3-3

6TD0-3-3

6TE0-3-3

-----

M10 x 15mm

M10 x 20mm

M12 x 20mm

Ø11 x 22mm

55 x 55mm Plate

139

146.5

146.5

146.5

142.5

153

-

15

20

20

22

-

### WHITE - RAL 9003



M10 x 15mm

M10 x 20mm

M12 x 20mm

Ø11 x 22mm

55 x 55mm Plate

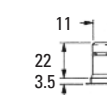
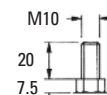
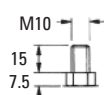

## SPECIFICATION

### CASTOR TYPE

Total Lock

### BEARING TYPE

Ball Bearings

### MATERIALS

Castor PA  
Soft Tyre PUR

### STANDARD COLOURS

Black  
Aluminium RAL 9006  
Grey RAL 7035  
White RAL 9003

### STANDARDS

EN 12530

## TECHNISCHE DATEN

### ROLLEN TYP

Totalfeststeller

### LAGER TYP

Kugellager

### MATERIAL

Rollen PA  
Weiche Lauffläche PUR

### STANDARDFARBEN

Schwarz  
Aluminium RAL 9006  
Lichtgrau RAL 7035  
Weiss RAL 9003

### NORMEN

EN 12530

## SPECIFICATION

### TYPE DE ROULETTE

Blocage Total

### ROULEMENT

Roulement à Billes

### MATIERES

Roulette PA  
Bandes Souples PUR

### COLORIS STANDARD

Noir  
Alu RAL 9006  
Gris Clair RAL 7035  
Blanc RAL 9003

### NORMES

EN 12530

## ESPECIFICACION

### TIPO DE RUEDA

Traba Total

### TIPO DE COJINETE

Cojinete de Bolas

### MMATERIALES

Rueda Nilón  
Rodadura Blanda Poliuretano

### COLORES ESTANDAR

Negro  
Plateado RAL 9006  
Gris RAL 7035  
Blanco RAL 9003

### NORMAS

EN 12530



125



139



48



11



67



43



134



Up to 100kg(x)  
(x) Depends on fixing

### NO.

6V00-1-1  
6VB0-1-1  
6VC0-1-1  
6VA0-1-1  
6VD0-1-1  
6VE0-1-1



-----  
M10 x 15mm  
M10 x 20mm  
M12 x 20mm  
Ø11 x 22mm  
55 x 55mm Plate

139  
146.5  
146.5  
146.5  
142.5  
153

-  
15  
20  
20  
22  
-

### BLACK



### NO.

6V00-64-64-T1  
6VB0-64-64-T1  
6VC0-64-64-T1  
6VA0-64-64-T1  
6VD0-64-64-T1  
6VE0-64-64-T1

-----  
M10 x 15mm  
M10 x 20mm  
M12 x 20mm  
Ø11 x 22mm  
55 x 55mm Plate

139  
146.5  
146.5  
146.5  
142.5  
153

-  
15  
20  
20  
22  
-

### ALUMINIUM - RAL 9006



### NO.

6V00-25-25  
6VB0-25-25  
6VC0-25-25  
6VA0-25-25  
6VD0-25-25  
6VE0-25-25

-----  
M10 x 15mm  
M10 x 20mm  
M12 x 20mm  
Ø11 x 22mm  
55 x 55mm Plate

139  
146.5  
146.5  
146.5  
142.5  
153

-  
15  
20  
20  
22  
-

### GREY - RAL 7035



### NO.

6V00-3-3  
6VB0-3-3  
6VC0-3-3  
6VA0-3-3  
6VD0-3-3  
6VE0-3-3

-----  
M10 x 15mm  
M10 x 20mm  
M12 x 20mm  
Ø11 x 22mm  
55 x 55mm Plate

139  
146.5  
146.5  
146.5  
142.5  
153

-  
15  
20  
20  
22  
-

### WHITE - RAL 9003



M10 x 15mm

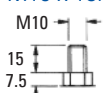

M10 x 20mm

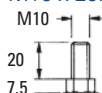

M12 x 20mm

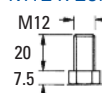

Ø11 x 22mm

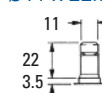

55 x 55mm Plate

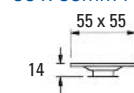

# GRX125B CONDUCTIVE BEARING CASTOR

## SPECIFICATION

### CASTOR TYPE

Swivel  
Conductive <100,000Ω

### BEARING TYPE

Ball Bearings

### MATERIALS

Castor PA  
Soft Tyre PUR

### STANDARD COLOURS

Black  
Grey

### STANDARDS

EN 12530

## TECHNISCHE DATEN

### ROLLEN TYP

Lenkrolle  
Leitfähig <100,000Ω

### LAGER TYP

Kugellager

### MATERIAL

Rolle PA  
Weiche Lauffläche PUR

### STANDARDFARBEN

Schwarz  
Grau

### NORMEN

EN 12530

## SPECIFICATION

### TYPE DE ROULETTE

Pivotante  
Antistatique <100,000Ω

### ROULEMENT

Roulement à Billes

### MATIERES

Roulette PA  
Bandes Souples PUR

### COLORIS STANDARD

Noir  
Gris

### NORMES

EN 12530

## ESPECIFICACION

### TIPO DE RUEDA

Giratorio  
Antiestática <100,000Ω

### TIPO DE COJINETE

Cojinete de Bolas

### MATERIALES

Rueda Nilón  
Rodadura Blanda Poliuretano

### COLORES ESTANDAR

Negro  
Gris

### NORMAS

EN 12530



125



139



48



11

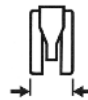

67

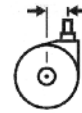

43



109



Up to 100kg(x)  
(x) Depends on fixing

### NO.

6T00-1-1-T2C  
6TB0-1-1-T2C  
6TC0-1-1-T2C  
6TA0-1-1-T2C  
6TD0-1-1-T2C  
6TE0-1-1-T2C



-----  
M10 x 15mm  
M10 x 20mm  
M12 x 20mm  
Ø11 x 22mm  
55 x 55mm Plate



139  
146.5  
146.5  
146.5  
142.5  
153



-  
15  
20  
20  
22  
-

### BLACK



### NO.

6T00-25-73-T2C  
6TB0-25-73-T2C  
6TC0-25-73-T2C  
6TA0-25-73-T2C  
6TD0-25-73-T2C  
6TE0-25-73-T2C

-----  
M10 x 15mm  
M10 x 20mm  
M12 x 20mm  
Ø11 x 22mm  
55 x 55mm Plate

139  
146.5  
146.5  
146.5  
142.5  
153

-  
15  
20  
20  
22  
-

### GREY



M10 x 15mm

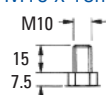

M10 x 20mm

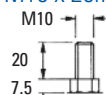

M12 x 20mm

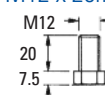

Ø11 x 22mm

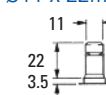

55 x 55mm Plate

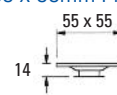

## SPECIFICATION

**CASTOR TYPE**  
Total Lock  
Conductive <100,000Ω  
**BEARING TYPE**  
Ball Bearings  
**MATERIALS**  
Castor PA  
Soft Tyre PUR  
**STANDARD COLOURS**  
Black  
Grey  
**STANDARDS**  
EN 12530

## TECHNISCHE DATEN

**ROLLEN TYP**  
Totalfeststeller  
Leitfähig <100,000Ω  
**LAGER TYP**  
Kugellager  
**MATERIAL**  
Rolle PA  
Weiche Lauffläche PUR  
**STANDARDFARBEN**  
Schwarz  
Grau  
**NORMEN**  
EN 12530

## SPECIFICATION

**TYPE DE ROULETTE**  
Blocage Total  
Antistatique <100,000Ω  
**ROULEMENT**  
Roulement à Billes  
**MATIERES**  
Roulette PA  
Bandes Souples PUR  
**COLORIS STANDARD**  
Noir  
Gris  
**NORMES**  
EN 12530

## ESPECIFICACION

**TIPO DE RUEDA**  
Freno Total  
Antiestática <100,000Ω  
**TIPO DE COJINETE**  
Cojinete de Bolas  
**MATERIALES**  
Rueda Nilón  
Rodadura Blanda Poliuretano  
**COLORES ESTANDAR**  
Negro  
Gris  
**NORMAS**  
EN 12530



125



139

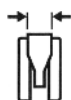

48



11



67

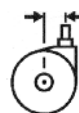

43



134



Up to 100kg(x)  
(x) Depends on fixing

### NO.

6V00-1-1-T2C  
6VB0-1-1-T2C  
6VC0-1-1-T2C  
6VA0-1-1-T2C  
6VD0-1-1-T2C  
6VE0-1-1-T2C



M10 x 15mm  
M10 x 20mm  
M12 x 20mm  
Ø11 x 22mm  
55 x 55mm Plate



139  
146.5  
146.5  
146.5  
142.5  
153



-  
15  
20  
20  
22  
-

### BLACK



### NO.

6V00-25-73-T2C  
6VB0-25-73-T2C  
6VC0-25-73-T2C  
6VA0-25-73-T2C  
6VD0-25-73-T2C  
6VE0-25-73-T2C

M10 x 15mm  
M10 x 20mm  
M12 x 20mm  
Ø11 x 22mm  
55 x 55mm Plate

139  
146.5  
146.5  
146.5  
142.5  
153

-  
15  
20  
20  
22  
-

### GREY



M10 x 15mm

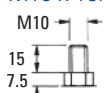

M10 x 20mm

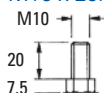

M12 x 20mm

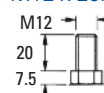

Ø11 x 22mm

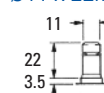

55 x 55mm Plate

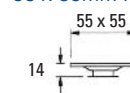

# GRX125B & GRX125BTL CHROME RANGE

## SPECIFICATION

**CASTOR TYPE**  
GRX125B Swivel  
GRX125BTL Total Lock

**BEARING TYPE**  
Ball Bearings

**MATERIALS**  
Castor PA  
Soft Tyre PUR  
Wheel Trim Chrome Plated ABS

**STANDARD COLOURS**  
Black

**STANDARDS**  
EN 12530

## TECHNISCHE DATEN

**ROLLEN TYP**  
GRX125B Lenkrolle  
GRX125BTL Totalfeststeller

**LAGER TYP**  
Kugellager

**MATERIAL**  
Rolle PA  
Weiche Lauffläche PUR  
Radkappen ABS Verchromt

**STANDARDFARBEN**  
Schwarz

**NORMEN**  
EN 12530

## SPECIFICATION

**TYPE DE ROULETTE**  
GRX125B Pivotante  
GRX125BTL Blocage Total

**ROULEMENT**  
Roulement à Billes

**MATIERES**  
Roulette PA  
Bandes Souples PUR  
Enjoliveurs ABS Chromé

**COLORIS STANDARD**  
Noir

**NORMES**  
EN 12530

## ESPECIFICACION

**TIPO DE RUEDA**  
GRX125B Giratoria  
GRX125BTL Freno Total

**TIPO DE COJINETE**  
Cojinete de Bolas

**MATERIALES**  
Rueda Nilón  
Rodadura Blanda Poliuretano  
Tapacubos ABS Cromado

**COLORES ESTANDAR**  
Negro

**NORMAS**  
EN 12530

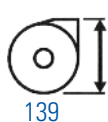

Up to 100kg(x)  
(x) Depends on fixing

### NO.

6T00-1-Z-T1  
6TB0-1-Z-T1  
6TC0-1-Z-T1  
6TA0-1-Z-T1  
6TD0-1-Z-T1  
6TE0-1-Z-T1



-----  
M10 x 15mm  
M10 x 20mm  
M12 x 20mm  
Ø11 x 22mm  
55 x 55mm Plate

139  
146.5  
146.5  
146.5  
142.5  
153

-  
15  
20  
20  
22  
-

### GRX125B CHROME



### NO.

6V00-1-Z-T1  
6VB0-1-Z-T1  
6VC0-1-Z-T1  
6VA0-1-Z-T1  
6VD0-1-Z-T1  
6VE0-1-Z-T1

-----  
M10 x 15mm  
M10 x 20mm  
M12 x 20mm  
Ø11 x 22mm  
55 x 55mm Plate

139  
146.5  
146.5  
146.5  
142.5  
153

-  
15  
20  
20  
22  
-

### GRX125BTL CHROME



### NO.

6T00-1-ZM-T1  
6TB0-1-ZM-T1  
6TC0-1-ZM-T1  
6TA0-1-ZM-T1  
6TD0-1-ZM-T1  
6TE0-1-ZM-T1

-----  
M10 x 15mm  
M10 x 20mm  
M12 x 20mm  
Ø11 x 22mm  
55 x 55mm Plate

139  
146.5  
146.5  
146.5  
142.5  
153

-  
15  
20  
20  
22  
-

### GRX125B MATT CHROME



### NO.

6V00-1-ZM-T1  
6VB0-1-ZM-T1  
6VC0-1-ZM-T1  
6VA0-1-ZM-T1  
6VD0-1-ZM-T1  
6VE0-1-ZM-T1

-----  
M10 x 15mm  
M10 x 20mm  
M12 x 20mm  
Ø11 x 22mm  
55 x 55mm Plate

139  
146.5  
146.5  
146.5  
142.5  
153

-  
15  
20  
20  
22  
-

### GRX125BTL MATT CHROME



M10 x 15mm    M10 x 20mm    M12 x 20mm    Ø 11 x 22mm    55 x 55mm Plate

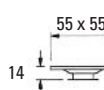
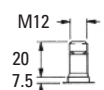



# GRX125B & GRX125BTL GOLD RANGE

## SPECIFICATION

**CASTOR TYPE**  
GRX125B Swivel  
GRX125BTL Total Lock

**BEARING TYPE**  
Ball Bearings

**MATERIALS**  
Castor PA  
Soft Tyre PUR  
Wheel Trim Gold Plated ABS

**STANDARD COLOURS**  
Black

**STANDARDS**  
EN 12530

## TECHNISCHE DATEN

**ROLLEN TYP**  
GRX125B Lenkrolle  
GRX125BTL Totalfeststeller

**LAGER TYP**  
Kugellager

**MATERIAL**  
Rolle PA  
Weiche Lauffläche PUR  
Radkappen ABS Vergoldet

**STANDARDFARBEN**  
Schwarz

**NORMEN**  
EN 12530

## SPECIFICATION

**TYPE DE ROULETTE**  
GRX125B Pivotante  
GRX125BTL Blocage Total

**ROULEMENT**  
Roulement à Billes

**MATIERES**  
Roulette PA  
Bandes Souples PUR  
Enjoliveurs ABS Plaquage Or

**COLORIS STANDARD**  
Noir

**NORMES**  
EN 12530

## ESPECIFICACION

**TIPO DE RUEDA**  
GRX125B Giratoria  
GRX125BTL Freno Total

**TIPO DE COJINETE**  
Cojinete de Bolas

**MATERIALES**  
Rueda Nílon  
Rodadura Blanda Poliuretano  
Tapacubos ABS Chapado En Oro

**COLORES ESTANDAR**

Negro  
**NORMAS**  
EN 12530

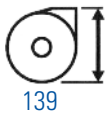

Up to 100kg(x)  
(x) Depends on fixing

### NO.

6T00-1-G-T1  
6TB0-1-G-T1  
6TC0-1-G-T1  
6TA0-1-G-T1  
6TD0-1-G-T1  
6TE0-1-G-T1



### GRX125B GOLD

-----  
M10 x 15mm  
M10 x 20mm  
M12 x 20mm  
Ø11 x 22mm  
55 x 55mm Plate

139  
146.5  
146.5  
146.5  
142.5  
153

-  
15  
20  
20  
22  
-



### NO.

6V00-1-G-T1  
6VB0-1-G-T1  
6VC0-1-G-T1  
6VA0-1-G-T1  
6VD0-1-G-T1  
6VE0-1-G-T1

-----  
M10 x 15mm  
M10 x 20mm  
M12 x 20mm  
Ø11 x 22mm  
55 x 55mm Plate

139  
146.5  
146.5  
146.5  
142.5  
153

-  
15  
20  
20  
22  
-

### GRX125BTL GOLD



### NO.

6T00-1-GM-T1  
6TB0-1-GM-T1  
6TC0-1-GM-T1  
6TA0-1-GM-T1  
6TD0-1-GM-T1  
6TE0-1-GM-T1

-----  
M10 x 15mm  
M10 x 20mm  
M12 x 20mm  
Ø11 x 22mm  
55 x 55mm Plate

139  
146.5  
146.5  
146.5  
142.5  
153

-  
15  
20  
20  
22  
-

### GRX125B MATT GOLD



### NO.

6V00-1-GM-T1  
6VB0-1-GM-T1  
6VC0-1-GM-T1  
6VA0-1-GM-T1  
6VD0-1-GM-T1  
6VE0-1-GM-T1

-----  
M10 x 15mm  
M10 x 20mm  
M12 x 20mm  
Ø11 x 22mm  
55 x 55mm Plate

139  
146.5  
146.5  
146.5  
142.5  
153

-  
15  
20  
20  
22  
-

### GRX125BTL MATT GOLD



M10 x 15mm

M10 x 20mm

M12 x 20mm

Ø 11 x 22mm

55 x 55mm Plate

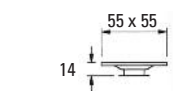
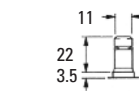
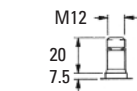
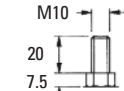
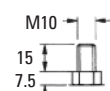



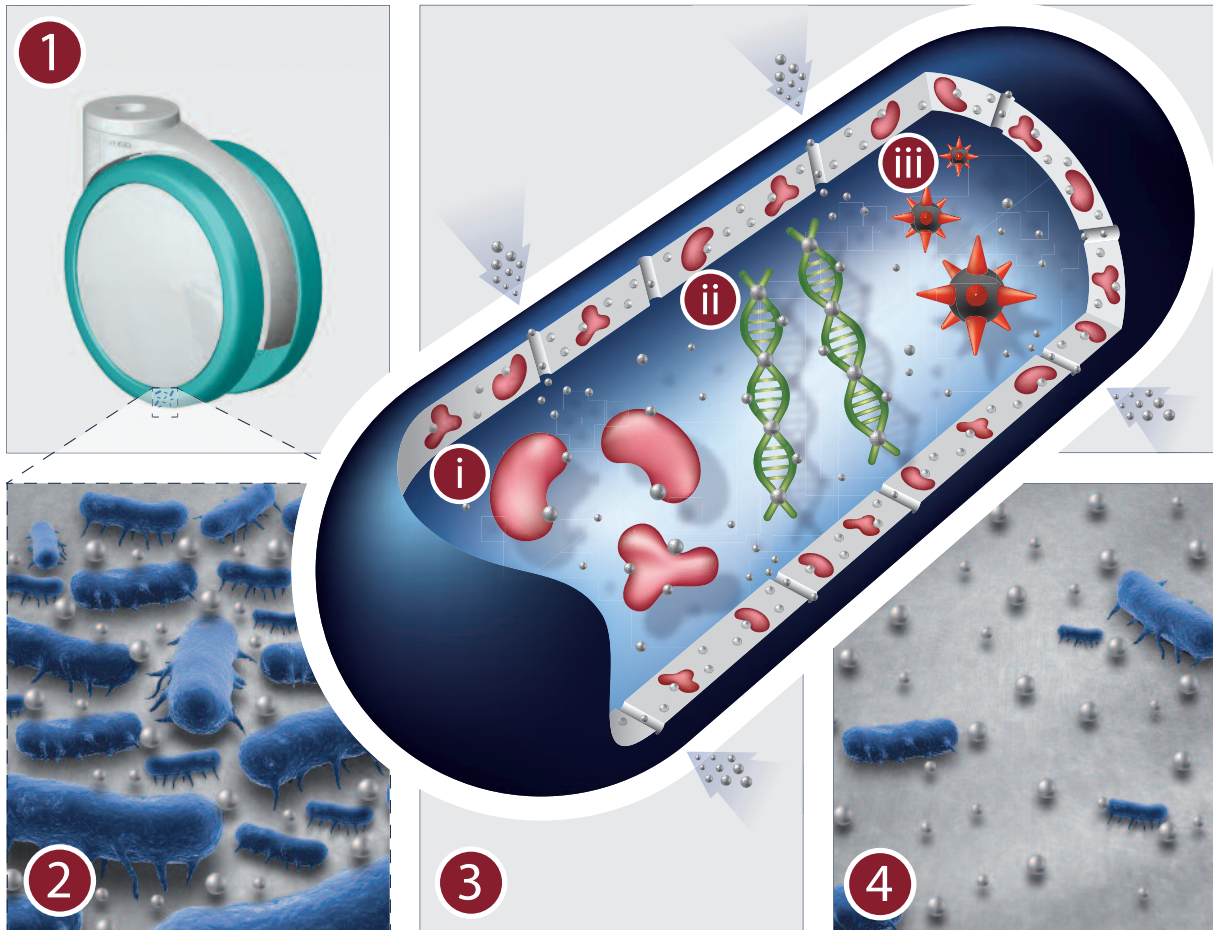

- 1** Microbes colonise surface of BioCote® protected GRX castor.  
 Mikroben auf der Oberfläche der GRX Rolle.  
 Les microbes contaminent la surface de la roulette GRX protégée par BioCote®.  
 Microorganismos contaminan la superficie de la rueda GRX protegida por BioCote®.
- 2** Silver ions are available to act against colonising microbes.  
 Silberionen kommen mit den Mikroben in Berührung.  
 Les ions d'argent sont prêts à agir contre les bactéries contaminantes.  
 Los iones de plata están disponibles para actuar sobre las bacterias contaminantes.
- 3** Silver ions act against microbes in three ways:  
 Die Mikroben werden in 3 Phasen angegriffen:  
 Les ions d'argent agissent contre les bactéries de trois façons:  
 Los iones de plata actúan sobre las bacterias de tres maneras:

  - i** Silver ions combine with microbe proteins in the cell and cell wall.  
 Silberionen verbinden sich mit Proteinen in Zellenwand und der Zelle.  
 Les ions d'argent s'associent avec les protéines intracellulaires et les protéines de la paroi cellulaire des bactéries:  
 Los iones de plata se unen con las proteínas de los microbios en las células y en sus membranas;
  - ii** Silver ions interfere with DNA replication.  
 Silberionen greifen die DNS Fortpflanzung an.  
 Les ions d'argent interfèrent avec la réplication de l'ADN;  
 Los iones de plata interfieren con la replicación de ADN;
  - iii** Silver ions promote formation of reactive oxygen species.  
 Silberionen regen Sauerstoffradikale in der Zelle an.  
 Les ions d'argent entraînent la formation d'espèces réactives.  
 Los iones de plata promueven la formación de especies de oxígeno reactivas.
- 4** Microbes die, GRX castor is cleaner and more hygienic to use.  
 Die Mikroben sterben ab.  
 Les bactéries meurent, et la roulette GRX est plus propre et plus hygiénique.  
 Los microbios mueren, y la rueda GRX está más limpia y más higiénica.



## GRX ANTIMICROBIAL CASTORS WITH BioCote® TECHNOLOGY

Designed for use in care homes, hospitals and other environments where surface protection from microbes is important, Guy-Raymond's antimicrobial castors incorporate BioCote® silver ion technology.

BioCote® technology:

- inhibits the growth of microbes such as odour causing and staining bacteria, moulds and fungi, disrupting the normal cell function of microbes and stopping them from reproducing;
- starts to have an effect after just 15 minutes;
- reduces the level of microbes on the treated surface by up to 99% in two hours;
- will not wear off or wash away, because the antimicrobial additive is incorporated into the castor tyre and pedal at the time of manufacture.

Further information about BioCote® technology is available at [www.biocote.com](http://www.biocote.com).

BioCote® is a registered trademark of BioCote Limited. This product does not protect users or others against disease causing bacteria, germs, viruses or other harmful organisms. BioCote always works best in environments which are regularly cleaned.  
This technology is not a substitute for good hygiene and/or cleaning practices.

## GRX ANTIMIKROBIELLE ROLLEN MIT BioCote® TECHNOLOGIE

Überall da wo Schutz vor Keimen, Bakterien, Viren und Schimmel an oberster Stelle steht. In Krankenhäusern, Pflegeheimen und Küchen hilft die neue Guy-Raymond GRX Antimicrobial Rollenserie mit BioCote® antimikrobiellen Silberionen.

Wie?

- Silberionen bekämpfen Viren, Bakterien und Schimmel, in dem sie die normalen Zellenfunktionen stören und somit deren Fortpflanzung und Verbreitung unterbinden.
- Die Wirkung der Silberionen kann schon nach 15 Minuten nachgewiesen werden.
- Nach 2 Stunden ist ein Mikrobenrückgang von bis zu 99% erkennbar.
- Es handelt sich nicht um eine einfache Beschichtung, die Wirkung der Silberionen nutzt nicht ab da es vor der Produktion der Rolle im Kunststoffgemisch des Rades und des Bremshebels mitinkorporiert wird.

Weitere Informationen zu BioCote® Silberionen finden Sie unter [www.biocote.com](http://www.biocote.com)

BioCote® ist ein eingetragenes Warenzeichen Marke der BioCote Limited. Dieses Produkt bieten seinen Benutzern oder Anderen keinen Schutz vor krankheitserregenden Bakterien, Keimen, Viren oder anderen Scadorganismen. Grundsätzlich funktioniert BioCote am besten in den Umgebungen, die regelmäßig gereinigt werden.  
Diese Technologie ist kein Ersatz für eine gute Hygiene-bzw. Reinigungspraxis.

## NOUVELLES ROULETTES GRX ANTIMICROBIENNES AVEC LA TECHNOLOGIE BioCote®

Destinées aux maisons de soins, aux hôpitaux et aux autres environnements dans lesquels la protection des surfaces contre les microbes est importante, les roulettes antimicrobiennes Guy-Raymond comportent la technologie d'ions d'argent BioCote®.

La technologie BioCote® :

- Inhibe la prolifération de bactéries, moisissures et champignons, perturbant leurs fonctions cellulaires normales et arrêtant leur multiplication.
- Commence à avoir de l'effet après seulement 15 minutes;
- Réduit les niveaux de contamination bactérienne sur les surfaces traitées jusqu'à 99% dans un délai de deux heures;
- Ne sera pas effacée ou enlevée par le nettoyage, car l'additif antimicrobien est intégré dans les bandes souples et la pédale de frein de la roulette lors de la fabrication.

Pour des renseignements complémentaires sur la technologie BioCote®, merci de consulter le site [www.biocote.com](http://www.biocote.com)

BioCote® est une marque déposée de BioCote Ltd. La technologie BioCote® ne remplace pas le nettoyage. Ce produit comporte la technologie antimicrobienne sous forme de verre de phosphate d'argent pour préserver la surface et prévenir la dégradation provoquée par la prolifération de microbes.

## RUEDAS GRX ANTIMICROBIANAS CON LA TECNOLOGIA BioCote®

Proyectadas para los productos destinados a hospitales y otros sitios que requieren altos niveles de higiene, las ruedas antimicrobianas de Guy-Raymond son protegidas por la tecnología de los iones de plata de BioCote®.

La tecnología BioCote® :

- inhibe el crecimiento de bacterias, moho y hongos, interrumpiendo sus funciones celulares normales y impidiendo su reproducción;
- empieza a tener efecto después de sólo 15 minutos;
- reduce los niveles microbianos hasta en 99% en dos horas;
- no se desgasta y no se le lleva la limpieza, porque el aditivo antimicrobiano es incorporado en el pedal de freno y la rodadura de la rueda en el momento de fabricación.

Más información sobre la tecnología BioCote® está disponible en el sitio [www.biocote.com](http://www.biocote.com)

BioCote® es una marca registrada de BioCote Limited. La tecnología BioCote no sustituye a la limpieza sino que la complementa. Este producto contiene la tecnología antimicrobiana (vidrio de fosfato de plata) para preservar la superficie y prevenir la degradación provocada por el crecimiento bacteriano.

# GRX5018 & GRX5018FB ANTIMICROBIAL CASTOR

## SPECIFICATION

### CASTOR TYPE

GRX5018 Swivel  
GRX5018FB Wheel Brake

### MATERIALS

Castor PA  
Soft Tyre PUR +  
Antimicrobial  
Pedal PA + Antimicrobial

### STANDARD COLOURS

Grey RAL 7035

### STANDARDS

EN 12528

## TECHNISCHE DATEN

### ROLLEN TYP

GRX5018 Lenkrolle  
GRX5018FB Radfeststeller

### MATERIAL

Rolle PA  
Weiche Lauffläche PUR +  
antimikrobischer Zusatzstoff  
Pedal PA + antimikrobischer Zusatzstoff

### STANDARDFARBEN

Lichtgrau RAL 7035

### NORMEN

EN 12528

## SPECIFICATION

### TYPE DE ROULETTE

GRX5018 Pivotant  
GRX5018FB Blocage de Roue

### MATIERES

Roulette PA  
Bandes Souples PUR +  
additif antimicrobien  
Pédale PA + additif antimicrobien

### COLORIS STANDARD

Gris Clair RAL 7035

### NORMES

EN 12528

## ESPECIFICACION

### TIPO DE RUEDA

GRX5018 Giratorio  
GRX5018FB Rueda con freno

### MATERIALES

Rueda Nilón  
Rodadura Blanda PUR +  
aditivo antimicrobiano  
Pedal Nilón + aditivo antimicrobiano

### COLORES ESTANDAR

Gris RAL 7035

### NORMAS

EN 12528



50



52.5



18



7



53

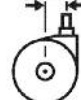

19



47.5 & 65



40kg & 35kg



52.5



22

### GRX5018 Antimicrobial

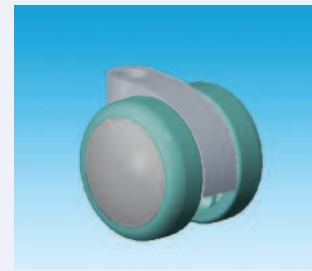

### NO.

6G00-2525-T91U  
6G03-2525-T91U  
6G08-2525-T91U  
6G20-2525-T91U  
6G02-2525-T91U  
6G04-2525-T91U  
6G51-2525-T91U

-----  
Ø 11 x 22mm  
Ø 10 x 22mm  
M8 x 15mm  
M10 x 15mm  
38 □ Plate  
42 □ Plate

56  
56  
59  
59  
61  
61

-  
22  
22  
15  
15  
-  
-

### NO.

6H00-2525TP91U  
6H03-2525TP91U  
6H08-2525TP91U  
6H20-2525TP91U  
6H02-2525TP91U  
6H04-2525TP91U  
6H51-2525TP91U

-----  
Ø 11 x 22mm  
Ø 10 x 22mm  
M8 x 15mm  
M10 x 15mm  
38 □ Plate  
42 □ Plate

52.5  
56  
56  
59  
59  
61  
61

-  
22  
22  
15  
15  
-  
-

### GRX5018FB Antimicrobial

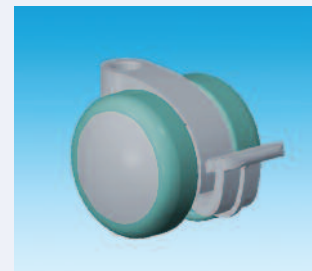

Ø 11 x 22mm



Ø 10 x 22mm



Ø 10 x 30mm



M8 x 15mm



M10 x 15mm



38 x 38mm Plate

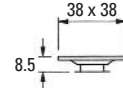

42 x 42mm Plate

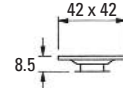

# GRX6518 & GRX6518FB ANTIMICROBIAL CASTOR

## SPECIFICATION

### CASTOR TYPE

GRX6518 Swivel  
GRX6518FB Wheel Brake

### MATERIALS

Castor PA  
Soft Tyre PUR +  
Antimicrobial  
Pedal PA + Antimicrobial

### STANDARD COLOURS

Grey RAL 7035

### STANDARDS

EN 12528

## TECHNISCHE DATEN

### ROLLEN TYP

GRX6518 Lenkrolle  
GRX6518FB Radfeststeller

### MATERIAL

Rolle PA  
Weiche Lauffläche PUR +  
antimikrobischer Zusatzstoff  
Pedal PA + antimikrobischer Zusatzstoff

### STANDARDFARBEN

Lichtgrau RAL 7035

### NORMEN

EN 12528

## SPECIFICATION

### TYPE DE ROULETTE

GRX6518 Pivotant  
GRX6518FB Blocage de Roue

### MATIERES

Roulette PA  
Bandes Souples PUR +  
additif antimicrobien  
Pédale PA + additif antimicrobien

### COLORIS STANDARD

Gris Clair RAL 7035

### NORMES

EN 12528

## ESPECIFICACION

### TIPO DE RUEDA

GRX6518 Giratorio  
GRX6518FB Rueda con freno

### MATERIALES

Rueda Nilón  
Rodadura Blanda PUR +  
aditivo antimicrobiano  
Pedal Nilón + aditivo antimicrobiano

### COLORES ESTANDAR

Gris RAL 7035

### NORMAS

EN 12528



65



66



18



7



53

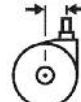

22.5



58 & 76



50kg



### NO.

6000-2525-T91U  
6003-2525-T91U  
6008-2525-T91U  
6002-2525-T91U  
6036-2525-T91U  
6004-2525-T91U  
6051-2525-T91U

-----  
Ø 11 x 22mm  
Ø 10 x 22mm  
M10 X 15mm  
M12 X 20mm  
38 □ Plate  
42 □ Plate

66  
69.5  
69.5  
72.5  
72.5  
74.5  
74.5

-  
22  
22  
15  
15  
-  
-

### GRX6518 Antimicrobial

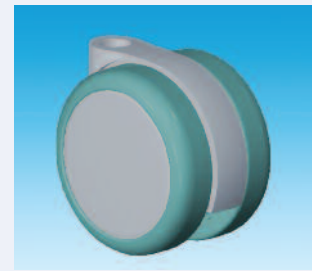

### NO.

5100-2525TP91U  
5103-2525TP91U  
5108-2525TP91U  
5102-2525TP91U  
5136-2525TP91U  
5104-2525TP91U  
5151-2525TP91U

-----  
Ø 11 x 22mm  
Ø 10 x 22mm  
M10 x 15mm  
M12 x 20mm  
38 □ Plate  
42 □ Plate

66  
69.5  
69.5  
72.5  
72.5  
74.5  
74.5

-  
22  
22  
15  
15  
-  
-

### GRX6518FB Antimicrobial



Ø 11 x 22mm

Ø 10 x 22mm

Ø 10 x 30mm

M10 x 15mm

M12 x 20mm

38 x 38mm Plate

42 x 42mm Plate

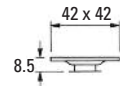
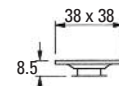

# GRX7522 & GRX7522TL ANTIMICROBIAL CASTOR

## SPECIFICATION

### CASTOR TYPE

Swivel or Total Lock (TL)

### MATERIALS

Castor PA  
Soft Tyre PUR +  
Antimicrobial  
Pedal PA + Antimicrobial

### STANDARD COLOURS

Grey RAL 7035

### STANDARDS

EN 12530

## TECHNISCHE DATEN

### ROLLEN TYP

Lenkrolle oder mit Totalfeststeller (TL)

### MATERIAL

Rolle PA  
Weiche Lauffläche PUR +  
antimikrobischer Zusatzstoff  
Pedal PA + antimikrobischer Zusatzstoff

### STANDARDFARBEN

Lichtgrau RAL 7035

### NORMEN

EN 12530

## SPECIFICATION

### TYPE DE ROULETTE

Pivotante ou Blocage Total (TL)

### MATIERES

Roulette PA  
Bandes Souples PUR +  
additif antimicrobien  
Pédale PA + additif antimicrobien

### COLORIS STANDARD

Gris Clair RAL 7035

### NORMES

EN 12530

## ESPECIFICACION

### TIPO DE RUEDA

Giratoria o Freno Total (TL)

### MATERIALES

Rueda Nilón  
Rodadura Blanda PUR +  
aditivo antimicrobiano  
Pedal Nilón + aditivo antimicrobiano

### COLORES ESTANDAR

Gris RAL 7035

### NORMAS

EN 12530



75



80



22



10



54



23.5



65 & 84



80



-



75

### NO.

6A00-2525-T91  
6A02-2525-T91  
6A36-2525-T91  
6A03-2525-T91  
6A08-2525-T91  
6A51-2525-T91  
6A09-2525-T91

-----  
M10 x 15mm  
M12 x 20mm  
Ø 11 x 22mm  
Ø 10 x 22mm  
42 □ Plate  
55 □ Plate

86.5  
86.5  
83.5  
83.5  
88.5  
91

15  
20  
22  
22  
-  
-

75  
75  
75  
75  
75  
50  
75

### GRX7522

### Antimicrobial

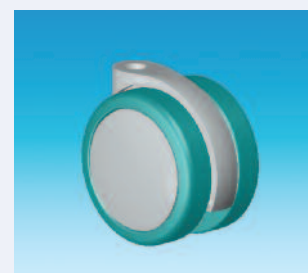

### NO.

6B00-2525-TP91  
6B71-2525-TP91  
6B73-2525-TP91  
6B79-2525-TP91  
6B80-2525-TP91  
6B70-2525-TP91  
6B77-2525-TP91

-----  
M10 x 15mm  
M12 x 20mm  
Ø 11 x 22mm  
Ø 10 x 22mm  
42 □ Plate  
55 □ Plate

80  
86.5  
86.5  
83.5  
83.5  
88.5  
91

-  
15  
20  
22  
22  
-  
-

75  
75  
75  
75  
75  
50  
75

### GRX7522TL

### Antimicrobial



M10 x 15mm



M12 x 20mm



Ø 11 x 22mm



Ø 10 x 22mm



42 x 42mm Plate

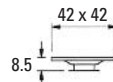

55 x 55mm Plate

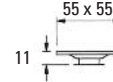

E-Mail: [info@guy-raymond.co.uk](mailto:info@guy-raymond.co.uk) Tel +44 (0)1553 761401 Fax +44 (0)1553 767459 [www.guy-raymond.com](http://www.guy-raymond.com)

© Copyright Guy-Raymond Engineering Company Limited October 2014.

We reserve the right to modify designs without prior notice.



# GRX7536 & GRX7536TL ANTIMICROBIAL CASTOR

## SPECIFICATION

### CASTOR TYPE

Swivel or Total Lock (TL)

### MATERIALS

Castor PA  
Soft Tyre PUR +  
Antimicrobial  
Pedal PA + Antimicrobial

### STANDARD COLOURS

Grey RAL 7035

### STANDARDS

EN 12530

## TECHNISCHE DATEN

### ROLLEN TYP

Lenkrolle oder mit Totalfeststeller (TL)

### MATERIAL

Rolle PA  
Weiche Lauffläche PUR +  
antimikrobischer Zusatzstoff  
Pedal PA + antimikrobischer Zusatzstoff

### STANDARDFARBEN

Lichtgrau RAL 7035

### NORMEN

EN 12530

## SPECIFICATION

### TYPE DE ROULETTE

Pivotante ou Blocage Total (TL)

### MATIERES

Roulette PA  
Bandes Souples PUR +  
additif antimicrobien  
Pédale PA + additif antimicrobien

### COLORIS STANDARD

Gris Clair RAL 7035

### NORMES

EN 12530

## ESPECIFICACION

### TIPO DE RUEDA

Giratoria o Freno Total (TL)

### MATERIALES

Rueda Nilón  
Rodadura Blanda PUR +  
aditivo antimicrobiano  
Pedal Nilón + aditivo antimicrobiano

### COLORES ESTANDAR

Gris RAL 7035

### NORMAS

EN 12530



75



80



36



10



54

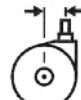

23.5



65 & 84



80



15



20

### GRX7536 Antimicrobial

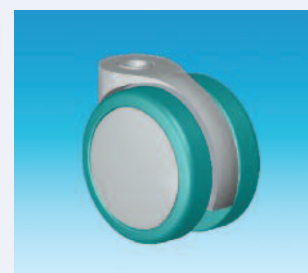

### NO.

4500-2525-T91  
4502-2525-T91  
4536-2525-T91  
4503-2525-T91  
4508-2525-T91  
4551-2525-T91  
4509-2525-T91

-----  
M10 x 15mm  
M12 x 20mm  
Ø 11 x 22mm  
Ø 10 x 22mm  
42 □ Plate  
55 □ Plate

86.5  
86.5  
83.5  
83.5  
88.5  
91

-  
15  
20  
22  
22  
-  
-

75  
75  
75  
75  
75  
50  
75

### NO.

4600-2525-TP91  
4671-2525-TP91  
4673-2525-TP91  
4679-2525-TP91  
4680-2525-TP91  
4670-2525-TP91  
4677-2525-TP91

-----  
M10 x 15mm  
M12 x 20mm  
Ø 11 x 22mm  
Ø 10 x 22mm  
42 □ Plate  
55 □ Plate

80  
86.5  
86.5  
83.5  
83.5  
88.5  
91

-  
15  
20  
22  
22  
-  
-

75  
75  
75  
75  
75  
50  
75

### GRX7536TL Antimicrobial



M10 x 15mm



M12 x 20mm



Ø 11 x 22mm



Ø 10 x 22mm



42 x 42mm Plate

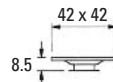

55 x 55mm Plate

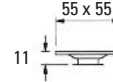

E-Mail: [info@guy-raymond.co.uk](mailto:info@guy-raymond.co.uk) Tel +44 (0)1553 761401 Fax +44 (0)1553 767459 [www.guy-raymond.com](http://www.guy-raymond.com)

© Copyright Guy-Raymond Engineering Company Limited October 2014.

We reserve the right to modify designs without prior notice.



# GRX100 & GRX100TL ANTIMICROBIAL CASTOR

## SPECIFICATION

### CASTOR TYPE

Swivel or Total Lock (TL)

### MATERIALS

Castor PA  
Soft Tyre PUR +  
Antimicrobial  
Pedal PA + Antimicrobial

### STANDARD COLOURS

Grey RAL 7035

### STANDARDS

EN 12530

## TECHNISCHE DATEN

### ROLLEN TYP

Lenkrolle oder mit Totalfeststeller (TL)

### MATERIAL

Rolle PA  
Weiche Lauffläche PUR +  
antimikrobischer Zusatzstoff  
Pedal PA + antimikrobischer Zusatzstoff

### STANDARDFARBEN

Lichtgrau RAL 7035

### NORMEN

EN 12530

## SPECIFICATION

### TYPE DE ROULETTE

Pivotante ou Blocage Total (TL)

### MATIERES

Roulette PA  
Bandes Souples PUR +  
additif antimicrobien  
Pédale PA + additif antimicrobien

### COLORIS STANDARD

Gris Clair RAL 7035

### NORMES

EN 12530

## ESPECIFICACION

### TIPO DE RUEDA

Giratoria o Freno Total (TL)

### MATERIALES

Rueda Nilón  
Rodadura Blanda PUR +  
aditivo antimicrobiano  
Pedal Nilón + aditivo antimicrobiano

### COLORES ESTANDAR

Gris RAL 7035

### NORMAS

EN 12530



100



113



36



10



57



36.5



89 or 111



### NO.

6M00-2525-T91  
6M53-2525-T91  
6M54-2525-T91  
6M52-2525-T91  
6M50-2525-T91  
6M58-2525-T91

-----  
M10 x 15mm  
M10 x 20mm  
M12 x 20mm  
Ø 11 x 22mm  
55 □ Plate

113  
121  
121  
121  
116.5  
124

-  
15  
20  
20  
22  
-

100  
75  
75  
100  
100  
100

### GRX100 Antimicrobial



### NO.

6N00-2525-TP91  
6N53-2525-TP91  
6N54-2525-TP91  
6N52-2525-TP91  
6N50-2525-TP91  
6N58-2525-TP91

-----  
M10 x 15mm  
M10 x 20mm  
M12 x 20mm  
Ø 11 x 22mm  
55 □ Plate

113  
121  
121  
121  
116.5  
124

-  
15  
20  
20  
22  
-

100  
75  
100  
100  
100  
100

### GRX100TL Antimicrobial



M10 x 15mm



M10 x 20mm



M12 x 20mm



Ø11 x 22mm



55 x 55mm Plate

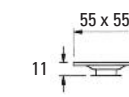

E-Mail: [info@guy-raymond.co.uk](mailto:info@guy-raymond.co.uk) Tel +44 (0)1553 761401 Fax +44 (0)1553 767459 [www.guy-raymond.com](http://www.guy-raymond.com)

© Copyright Guy-Raymond Engineering Company Limited October 2014.

We reserve the right to modify designs without prior notice.

# GRX125B & GRX125BTL ANTIMICROBIAL CASTOR

## SPECIFICATION

### CASTOR TYPE

Swivel or Total Lock (TL)

### MATERIALS

Castor PA  
Soft Tyre PUR +  
Antimicrobial  
Pedal PA + Antimicrobial

### STANDARD COLOURS

Grey RAL 7035

### STANDARDS

EN 12530

## TECHNISCHE DATEN

### ROLLEN TYP

Lenkrolle oder mit Totalfeststeller (TL)

### MATERIAL

Rolle PA  
Weiche Lauffläche PUR +  
antimikrobischer Zusatzstoff  
Pedal PA + antimikrobischer Zusatzstoff

### STANDARDFARBEN

Lichtgrau RAL 7035

### NORMEN

EN 12530

## SPECIFICATION

### TYPE DE ROULETTE

Pivotante ou Blocage Total (TL)

### MATIERES

Roulette PA  
Bandes Souples PUR +  
additif antimicrobien  
Pédale PA + additif antimicrobien

### COLORIS STANDARD

Gris Clair RAL 7035

### NORMES

EN 12530

## ESPECIFICACION

### TIPO DE RUEDA

Giratoria o Freno Total (TL)

### MATERIALES

Rueda Nilón  
Rodadura Blanda PUR +  
aditivo antimicrobiano  
Pedal Nilón + aditivo antimicrobiano

### COLORES ESTANDAR

Gris RAL 7035

### NORMAS

EN 12530



125



139



48



11



67

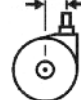

43



109 or 134



### NO.

6T00-2525-T91  
6TB0-2525-T91  
6TC0-2525-T91  
6TA0-2525-T91  
6TD0-2525-T91  
6TE0-2525-T91

-----  
M10 x 15mm  
M10 x 20mm  
M12 x 20mm  
Ø 11 x 22mm  
55 □ Plate

139  
146.5  
146.5  
146.5  
142.5  
153

-  
15  
20  
20  
22  
-

100  
65  
65  
100  
90  
100

### GRX125B Antimicrobial

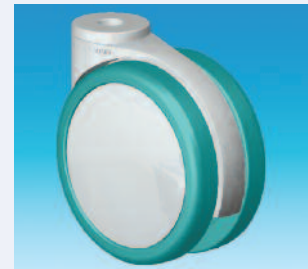

### NO.

6V00-2525-TP91  
6VB0-2525-TP91  
6VC0-2525-TP91  
6VA0-2525-TP91  
6VD0-2525-TP91  
6VE0-2525-TP91

-----  
M10 x 15mm  
M10 x 20mm  
M12 x 20mm  
Ø 11 x 22mm  
55 □ Plate

139  
146.5  
146.5  
146.5  
142.5  
153

-  
15  
20  
20  
22  
-

100  
65  
65  
100  
90  
100

### GRX125BTL Antimicrobial



M10 x 15mm

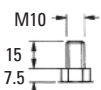

M10 x 20mm

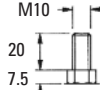

M12 x 20mm

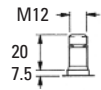

Ø 11 x 22mm

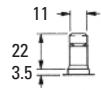

55 x 55mm Plate

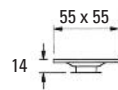

# GR BUFFER

## SPECIFICATION

### MATERIALS

PP and EVA

### STANDARD COLOURS

Grey

## TECHNISCHE DATEN

### MATERIAL

PP und EVA

### STANDARDFARBEN

Grau

## SPECIFICATION

### MATIERES

PP et EVA

### COLORIS STANDARD

Gris

## ESPECIFICACION

### MATERIALES

PP y EVA

### COLORES ESTANDAR

Gris

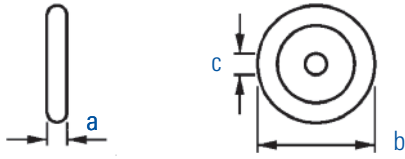

NO.		a	b	c
4F00-BO	GR BUFFER 20mm Bore	27mm	110-115mm	20mm

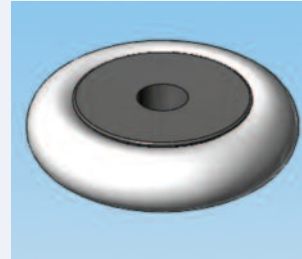

# GR BUFFER MOUNTING BUSHES

## SPECIFICATION

### MATERIALS

Steel BZP

## TECHNISCHE DATEN

### MATERIAL

Stahl Verzinkt

## SPECIFICATION

### MATIERES

Acier, plaqué de zinc

## ESPECIFICACION

### MATERIALES

Acero, chapado de zinc

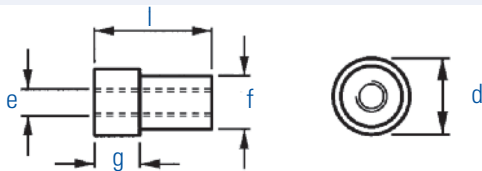

NO.		e	f	g	d	l
1854P	GR Buffer mounting bush $\varnothing 25 \times 44$ mm long	M10	20	17	25	44
1876P	GR Buffer mounting bush $\varnothing 25 \times 32$ mm long	M10	20	5	25	32
1877P	GR Buffer mounting bush $\varnothing 25 \times 32$ mm long	M12	20	5	25	32



## SPECIFICATION

### MATERIALS

GRX50, GRX65 PE  
GRX75, 100 & 125 PP

### STANDARD COLOURS

Red and Natural

## TECHNISCHE DATEN

### MATERIAL

GRX50, GRX65 PE  
GRX75, 100 & 125 PP

### STANDARDFARBEN

Rot und Natur

## SPECIFICATION

### MATIERES

GRX50, GRX65 PE  
GRX75, 100 & 125 PP

### COLORIS STANDARD

Rouge et naturel

## ESPECIFICACION

### MATERIALES

GRX50, GRX65 PE  
GRX75, 100 & 125 PP

### COLORES ESTANDAR

Rojo y Natural

### NO.

9A301041  
9A121041  
9A191046  
9A201046  
9A291046

GRX50 Wheel Tread Protector - Red  
GRX65 Wheel Tread Protector - Red  
GRX75 Wheel Tread Protector - Red  
GRX100 Wheel Tread Protector - Red  
GRX125 Wheel Tread Protector - Red



### NO.

9A301041-ASS  
9A121041-ASS  
9A191046-ASS  
9A201046-ASS  
9A291046-ASS

GRX50 Wheel Tread Protector Assembled - Red  
GRX65 Wheel Tread Protector Assembled - Red  
GRX75 Wheel Tread Protector Assembled - Red  
GRX100 Wheel Tread Protector Assembled - Red  
GRX125 Wheel Tread Protector Assembled - Red



### NO.

9A301401  
9A121401  
9A191406  
9A201406  
9A291406

GRX50 Wheel Tread Protector - Natural  
GRX65 Wheel Tread Protector - Natural  
GRX75 Wheel Tread Protector - Natural  
GRX100 Wheel Tread Protector - Natural  
GRX125 Wheel Tread Protector - Natural



### NO.

9A301401-ASS  
9A121401-ASS  
9A191406-ASS  
9A201406-ASS  
9A291406-ASS

GRX50 Wheel Tread Protector Assembled - Natural  
GRX65 Wheel Tread Protector Assembled - Natural  
GRX75 Wheel Tread Protector Assembled - Natural  
GRX100 Wheel Tread Protector Assembled - Natural  
GRX125 Wheel Tread Protector Assembled - Natural

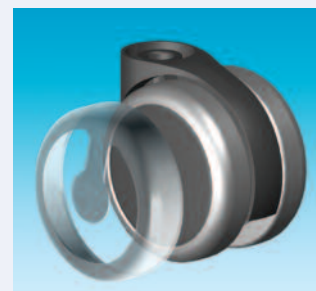

# GUY-RAYMOND ENGINEERING COMPANY LIMITED

## TERMS AND CONDITIONS OF SALE

### 1. THE CONTRACT

These conditions shall form part of every contract of sale entered into by Guy-Raymond Engineering Company Limited ("the Company") and any purported variation or exclusion (whether contained in any document of the buyer or otherwise) shall be of no effect unless accepted in writing by an authorised representative of the Company.

### 2. ORDERS AND SPECIFICATIONS

- 2.1 An order whether or not based upon a quotation shall not be binding on the Company unless accepted in writing by an authorised representative of the Company and where goods are supplied from the Company's stock despatch of the Company's invoice to the buyer shall be deemed such written acceptance.
- 2.2 All quotations are made subject to the goods or materials being available on receipt of the order.
- 2.3 All specifications, drawings and particulars supplied by the Company are approximate only unless otherwise stated and the Company reserves the right to alter specifications and make modifications without notice to the buyer.
- 2.4 Where the Company manufactures or applies a process to the goods as specified by the buyer, the buyer shall fully indemnify the Company in any third parties' claim for infringement of its intellectual property rights resulting from the Company's use of the buyer's specification.

### 3. PRICE

- 3.1 Unless otherwise stated all prices quoted are exclusive of VAT.
- 3.2 All prices are subject to revision without notice and will be invoiced at prices ruling at the date of invoice.
- 3.3 The buyer shall at the Company's written request pay a charge in addition to the price of the goods where special moulds, dies, tools or fixtures are required for production of the goods and which remain the property of the Company.
- 3.4 The buyer shall at the Company's written request pay a charge in addition to the price of the goods for all tests or modifications requested by the buyer after acceptance of the order.

### 4. PAYMENT

- 4.1 Where goods are delivered in the United Kingdom the payment terms of this clause 4 shall apply and where goods are for export the payment terms of clause 10 apply.
- 4.2 All sums become due and payable under these terms and conditions not later than 28 days from the date of invoice time being of the essence.
- 4.3 The Company reserves the right to charge interest at 3 per centum per annum above National Westminster Bank plc base rate from time to time in force on all overdue accounts, such interest being deemed to accrue on a day to day basis from the due date for payment in full.
- 4.4 If the buyer shall default in payment on the due date the Company shall be entitled to cancel the contract or suspend further deliveries of goods to the buyer whether or not ordered under the same contract and to stop any goods in transit.
- 4.5 If the buyer (being a Company) has a petition presented for its winding-up or the appointment of an Administrator or passes a resolution for voluntary winding-up otherwise than for the purpose of a bona fide amalgamation or reconstruction or compounds or enters into any arrangement with its creditors or has a Receiver or Administrative Receiver appointed of all or any part of its assets or (being an individual) becomes bankrupt or insolvent or enters into any arrangement with his creditors or any judgement is obtained against the buyer or any distress or execution is levied on any premises owned or occupied by the buyer or the buyer ceases or threatens to cease to carry on business or commits a material or serious breach of the contract or the Company reasonably apprehends any of the above events is likely to occur and notifies the buyer accordingly then the buyer will be deemed to have repudiated the contract and all sums owing to the Company on any account shall become due and payable immediately notwithstanding any previous agreement or arrangement to the contrary.

### 5. DELIVERY

- 5.1 Delivery dates are estimates only and time of delivery is not of the essence of the contract.
- 5.2 The Company shall not be liable for any loss whatever or however arising caused by its non-delivery.
- 5.3 The Company reserves the right to make delivery by instalments and to tender a separate invoice in respect of each instalment.
- 5.4 Where goods are sold to the buyer in the United Kingdom and are not for export the buyer shall either itself or by its duly authorised representative sign the delivery ticket as acknowledgement of delivery provided that on delivery to the address nominated by the buyer the Company shall be entitled to assume that any signature given is that of such a representative.
- 5.5 The Company reserves the right to deliver up to 10% more or less than the quantity ordered and adjust the price pro rata.
- 5.6 The Company reserves the right to invoice and deliver goods made to the buyer's specification notwithstanding the termination of the contract however caused.

### 6. INSPECTION

- 6.1 The Company shall have no liability for any defects or shortages that would be apparent on careful inspection on delivery unless a written complaint is delivered to the Company within 7 days of delivery detailing the alleged defect or shortage.
- 6.2 The Company's liability in respect of such defects or shortages shall be limited to replacing or repairing or giving credit for such goods as determined by the Company.

### 7. TITLE AND RISK

- 7.1 Title in all the goods shall remain in the Company until payment due under all contracts is received in full or until title passes in accordance with clause 7.2 (whichever is the sooner).
- 7.2 Clause 7.1 shall not prevent the buyer from agreeing to sell the goods and in the event of such agreement title in the goods shall

remain with the Company until such time as title in the goods is to pass to the sub-purchaser and payment is received under the terms of the said agreement.

- 7.3 The relationship between the Company and the Buyer shall be fiduciary in respect of the goods until such times as title in the goods passes from the Company. In the event that title in the goods passes from the Company by virtue of a sale under clause 7.2 the fiduciary relationship of the Company's proprietary right shall transfer to the proceeds thereof and (without prejudice to the above) the buyer shall hold the said proceeds on trust for the Company in a separate bank account opened for this purpose to make or complete full payment for the goods.
- 7.4 If the buyer shall default in payment on the due date or if any event specified in clause 4.5 shall occur the Company shall be entitled to repossess the goods and the buyer shall grant the Company an irrevocable licence to enter upon any land or premises where goods are situated for the time being to recover the goods. This right shall continue to subsist notwithstanding the termination of the contract for any reason and is without prejudice to any other rights of the Company.
- 7.5 The risk in the goods shall pass to the buyer upon delivery.

### 8. REPRESENTATIONS

- 8.1 The buyer is responsible for the suitability of the goods.
- 8.2 The goods are supplied by the Company on the basis that they conform to the written terms and to any description contained in this document. No other representations, terms, conditions or warranties of any sort whatever whether written or oral alleged to have been made or entered into by the Company or any servant or agent of the Company shall be of any force or effect.

### 9. GUARANTEE

- 9.1 Subject to the conditions of this clause 9 the purchase price of the goods will be refunded or at the Company's option the defective part or parts of the goods will be replaced if the Company is satisfied that they were defective in materials and workmanship on delivery and notice of the defect is given to the Company within six months of delivery and the goods are returned carriage paid.
- 9.2 The Company shall have no further liability in respect of the goods or any defects therein and all conditions and warranties whether express or implied by law as to the quality of the goods or their fitness for a particular purpose or otherwise are expressly excluded except insofar as statute provides to the contrary.
- 9.3 The Company shall not be responsible for any injury damage or loss caused directly or indirectly by the goods whether as a result of their operation or use or otherwise and whether as a result of any defect or otherwise and the buyer shall indemnify the Company from any claim arising from such injury damage or loss suffered by any third party except insofar as statute provides to the contrary.
- 9.4 Where the goods are sold under a consumer sale (as defined by the Sale of Goods Act 1979) the statutory rights of the buyer are not affected by these conditions.
- 9.5 The Company's liability in respect of the goods under this clause 9 shall not exceed the purchase price of the goods.

### 10. EXPORT ITEMS

- 10.1 Where the goods are supplied for export from the United Kingdom the provisions of this clause 10 shall apply.
- 10.2 The buyer shall be responsible for complying with any legislation or regulations governing importation into the country of destination and for payment of any duties.
- 10.3 The Company shall specify the terms of delivery on its written acceptance of order under clause 2.1 as either C.I.F. main sea port or F.O.B. the UK air or sea port of shipment in which event the Company shall be under no obligation to give notice under section 32 (3) of the Sale of Goods Act 1979.
- 10.4 The buyer shall be responsible for arranging for testing and inspection of the goods before shipment at the Company's premises and the Company shall not be liable for any claim in respect of any defect in the goods which would be apparent on inspection and which is made after shipment, or in respect of any damage during transit.
- 10.5 The terms of payment shall be agreed in advance in writing by a duly authorised representative of the Company.

### 11. INTELLECTUAL PROPERTY

The copyright, design right, registered design, patent, trade mark or any other intellectual property right in relation to the goods and tooling remains the property of the Company.

### 12. FORCE MAJEURE

The Company will not be liable for any loss or consequential liability or damage resulting from any delay in performing or failure to perform the contract by reason of an act of God, explosion, flood, fire war, riot, strike, lock-out, government control or regulation, abnormal weather conditions, accident, breakdown or any other circumstances beyond the Company's control.

### 13. GENERAL

- 13.1 These Terms and Conditions as amended from time to time will apply to any subsequent orders placed by the buyer.
- 13.2 No waiver by the Company of any breach of the contract by the buyer shall be considered as a waiver by any subsequent breach of the same or any other provision.
- 13.3 Any notice to be given shall be in writing and shall be deemed to have been duly given if sent or delivered to the buyer at its registered office or principal place of business or such other address as may at the relevant time have been notified to the Company pursuant to this clause 13.3 and shall be deemed to have been served, if sent by post, 48 hours after posting or if by telex or facsimile transmission at the time of sending.
- 13.4 The contract shall be governed by English law. The only tribunals with authority to determine any dispute arising directly or indirectly from the contract shall be the Courts of England.





