

The background is a close-up of a marbled porcelain surface. It features a complex pattern of organic, flowing lines in shades of light grey, white, and beige. A prominent horizontal band of vibrant, textured orange and reddish-brown runs across the middle. Below this band, there are patches of yellow and muted green, interspersed with the lighter grey and white tones. The overall effect is one of natural, earthy beauty and depth.

materiality

EXPANDING IDEAS WITH PORCELAIN SURFACES

TAILOR-MADE⁺

EXPANDING SURFACES

SERVICES

- 5 **UNLOCK THE POTENTIAL OF THE SLAB**
- 6 **INTRODUCING CUT-TO-SIZE**

WALL

- 7 **VERTICAL CLADDING** WORKING WITH LARGE FORMATS
- 11 **WALLS** DESIGN 3D WALLS WITH FORM
- 14 **HOSPITALITY**
- 19 **FIREPLACES** 3D SURROUNDS

FLOOR

- 20 **BESPOKE FLOORING DESIGNS**
- 21 **LARGE FORMAT CUSTOM DESIGNS**
- 23 **INLAID FLOORING**
- 24 **FLOORING PROCESS**

INLAYS AND TOPS

- 25 **FURNITURE INLAYS**
- 27 **TABLE TOPS**

3D CLADDING APPLICATIONS

- 29 **3D CLADDING** PRACTICAL APPLICATIONS
- 30 **PLINTHS** DISPLAY STANDS
- 31 **COUNTERS** RECEPTION COUNTERS AND DESKS
- 34 **STEPS AND TREADS** INDOOR AND OUTDOOR PROJECTS
- 37 **NOSING** TREAD AND NOSING PROFILES
- 41 **PROFILING** MITRES AND EDGE PROFILES
- 42 **SURFACE DECOR** FLUTED AND STRIPS DECOR

EXPANDING IDEAS: CUCINA COLLECTION

PROJECTS

- 44 **PROJECT_01:** ISLAND LIFE
- 48 **PROJECT_02:** THE ULTIMATE GATHERING SPOT
- 53 **PROJECT_03:** ISLAND MAKEOVER
- 58 **PROJECT_04:** THE HEART OF THE HOME
- 62 **PROJECT_05:** THE TASTE OF LUXURY
- 66 **PROJECT_06:** MULTITASKING AT ITS FINEST
- 69 **PROJECT_07:** PLAYING TO THE GALLERY

- 73 **COUNTERTOP PROFILES** EDGE PROFILE OPTIONS
- 74 **CUT-OUTS** HOB CUT-OUTS & SINK OPTIONS
- 75 **SPLASHBACKS & UPSTANDS**
- 77 **TABLEWARE** LUXURY SERVING TRAY & COASTER SET

EXPANDING IDEAS: BATHROOM AND WELLNESS

WASHBASINS

- 90 **GEMINI** SURFACE-MOUNTED SINGLE WASHBASIN
- 92 **LIBRA** WALL-MOUNTED SINGLE WASHBASIN
- 96 **LEO** WALL-MOUNTED SLIMLINE WASHBASIN
- 100 **CAPRICORN** WALL-MOUNTED DOUBLE WASHBASIN
- 104 **SCORPIO** WALL-MOUNTED DOUBLE TROUGH BASIN

VANITIES

- 106 **VIRGO** VANITY TOP WITH STORAGE
- 109 **VANITY TOP** WALL-MOUNTED VANITY TOP FOR VESSEL BASIN
- 110 **VANITY TOP WITH CUT-OUT** VANITY TOP FOR DROP-IN BASIN
- 115 **VANITY SHELF** WALL-MOUNTED VANITY SHELF
- 116 **GLOBO** BATHROOM STORAGE UNIT

FREE-STANDING BASINS

- 118 **VENUS** FREE-STANDING SINGLE WASHBASIN
- 121 **SATURN** LUXURY FREE-STANDING DOUBLE BASIN
- 122 **MERCURY** FREE-STANDING TROUGH WASHBASIN

BATHROOM ADDITIONS

- 125 **BASIN BASE & TAP SYSTEMS**
- 126 **POCKETS, CAVITIES & RECESSES**
- 127 **STORAGE OPTIONS**
- 128 **VENEER** COLOUR OPTIONS
- 129 **SHOWER TRAY** LOW PROFILE TRAY WITH DRAINAGE SYSTEM
- 130 **3D MIRROR** DEEP FRAMED VANITY MIRROR

EXPANDING IDEAS: FURNITURE COLLECTION

COLLECTION ROMANO

- 134 **TAVOLINO ROMANO**
- 137 **TAVOLO LUNA ROMANO**
- 138 **TAVOLO MEZZALUNA ROMANO**

COLLECTION ORIGAMI

- 139 **TAVOLINO ORIGAMI**
- 141 **TAVOLO ORIGAMI**
- 143 **CONSOLE ORIGAMI**

COLLECTION VENEZIANA

- 145 **TAVOLO MEZZALUNA VENEZIANA**
- 147 **TAVOLO LUNA VENEZIANA**
- 149 **TAVOLO TELESTO VENEZIANA**
- 151 **CONSOLE VENEZIANA**

COLLECTION GESSATO

- 153 **CONSOLE GESSATO**
- 155 **TAVOLO GESSATO**

DESIGNER COMMISSIONS

- 157 **TAVOLINO TORNIO**
- 159 **TAVOLINO CUBO**

TABLE OPTIONS

- 161 **TABLE TOP** CONFIGURATION
- 162 **TABLE TOP** PROFILES
- 163 **PROFILE BANDING** COLOUR OPTIONS
- 164 **PODIUM** SIDE TABLE PLINTH
- 167 **KITCHEN COUNTERTOPS** REMODEL ISLANDS AND WORKTOPS

SURFACES & COLOURS

PORCELAIN SURFACES

- 172 **PORCELAIN SURFACES REDEFINED**
- 173 **MARBLE**
- 174 **ONYX & MARBLE**
- 175 **PRECIOUS STONE & GRANITE**
- 176 **WOOD EFFECT**

SLAB TO SURFACE

By combining beauty with technology and sustainability, Italian porcelain slabs have expanded design limits and streamlined production processes to enable the creation of ever more dynamic spaces... but this innovative material is not only for walls and floors.

Through our full service technical and design solution we are striving to **change attitudes** towards large format slabs. By coaching and informing about the versatility and aesthetic personality, we hope to inspire designers to think of each slab as a **creative surface**, one that has the power to define the form of the built space.

As awareness increases through the expansion of innovative design applications, and our commitment to lead by example, we continue to shift attitudes towards porcelain slabs. We offer support for architects, designers, and product manufacturers to incorporate these surfaces into their designs in new and innovative ways. This alliance can lead the way, demonstrating the material's potential and **inspiring others** to do the same.

Slowly we re-frame the perception of the slab as a surface and move towards our long-term strategy to **change cultural perception**. Together we can celebrate the *materiality* of these expansive surfaces and harness their ability to define form in a space.

materiality

[ma-te-ri-al-i-ty] *noun*

1. Materiality is the strategic use of materials to create products that are not only visually appealing, but also functional, durable, and sustainable. 2. Materiality serves as a medium that articulates ideas into a built form. 3. Materiality is an attempt to give noise to a space.

See also: *space, form, personality.*

ITALIAN PORCELAIN SURFACES

Detailed within this catalogue are products, specifications, and services designed to instil confidence in designers towards the progression from slab to surface. Services that redefine how architects approach material selection, providing design solutions for the functional and aesthetic requirements of each project. Services that facilitate the creation of luxury stand-alone products such as bathroom vanities, kitchen countertops and furniture. Services that assist designers to transform their ideas into completed products.

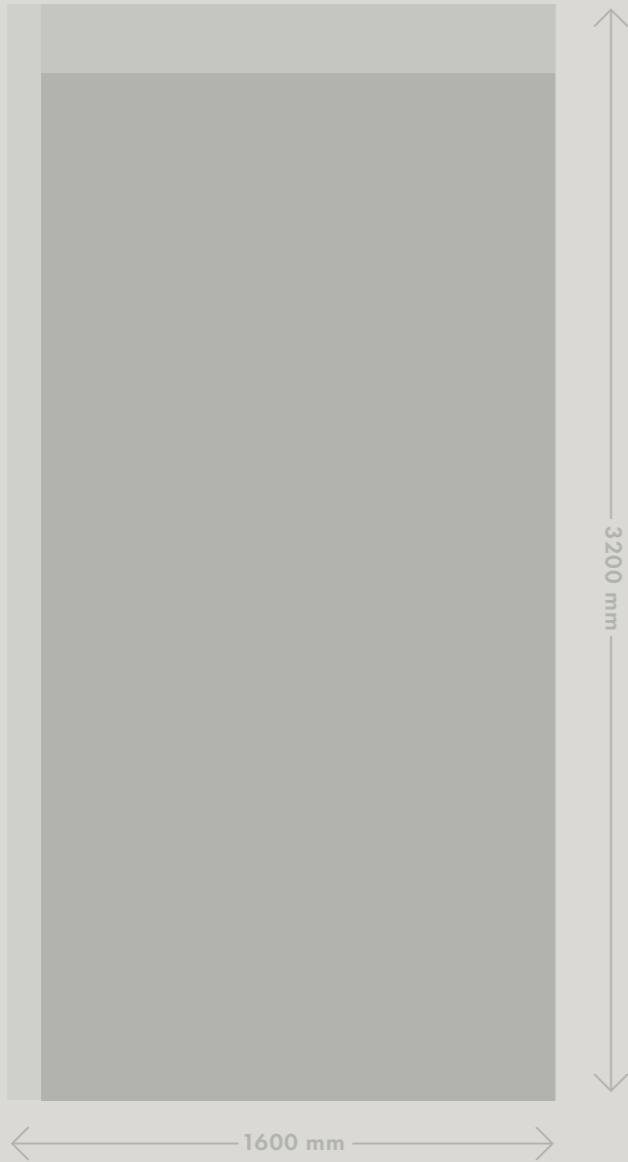

UNLOCK THE POTENTIAL OF THE SLAB

Large format porcelain slabs are one of the most sustainable and aesthetically appealing surface materials available in the world today. The wider availability of this cutting-edge surface in the UK has transformed the way these materials are used, presenting new beginnings, opportunities, and challenges. To unlock the full potential of large format porcelain slabs, a comprehensive UK-based cut-to-size solution is essential.



We are that solution.

Our new cut-to-size and cut-to-shape services empower designers to expand their creative boundaries and reach their design objectives. Cut-to-size benefits architects, designers, and contractors by providing practical solutions to design challenges. It is a comprehensive service that revolutionises how porcelain slabs are specified, offering considerable execution advantages. These advantages include shorter lead times, reduced onsite assembly and installation, less material wastage and lower risk of onsite damages.

INTRODUCING CUT-TO-SIZE

Porcelain slabs offer an extremely durable surface, but cutting and handling three metre high large formats onsite brings its own challenges, which can often result in chipping or cracking. By utilising our cut-to-size solution, the entire cutting process takes place offsite and is risk-free to you.

Cut-to-size eliminates the need for third-party operations including the transport of slabs between suppliers. Use cut-to-size for surface cladding, custom flooring, inlays and staircases. Also for projects where space is limited and manoeuvring full size slabs is impractical.

This level of support allows designers to have a relaxed approach to specifying large formats, and gives installers the confidence to handle slabs onsite and complete projects successfully. It's a collaboration that adds considerable value to a project, combining our expertise with your creativity, allowing this high-performing material to be specified with confidence and ease.



CUT-TO-SIZE LIGHTING INSTALLATION USING 6MM SLABS (FIG.6.1)

VERTICAL CLADDING

Achieving visual and tactile consistency in a given interior space through the harmonious use of materials, colours, and textures is a fundamental principle of interior design. Cladding is a highly effective way to achieve this, but this does not have to stop at the walls.

Being able to specify large formats on additional vertical surfaces provides exciting new design opportunities. With three metre long slabs you can promote this grand sense of scale, taking full advantage of less grout lines for a more seamless result. Experiment with pattern matching across cladded surfaces and achieve homogeneity and coherence in the design that is not possible with standard formats.

Leverage the longer lengths available with large format porcelain slabs to add interest to architectural details, including mouldings, columns, door skins, steps, archways, fireplace surrounds and feature walls.



VERTICAL CLADDING WITH PERFECTLY ALIGNED VEIN MATCHING (FIG.7.1)



PERFECTLY ALIGNED VEIN MATCHING (FIG.8.1)

CLADDING WITH VEIN MATCHING

Vein matching involves placing panels so that the vein movement found in the material continues across adjacent surfaces. This veining flows from one piece onto the other creating a continuous vein pattern.

Through our cut-to-size services, vein matching can be maintained across cladded surfaces. By pre-cutting each panel offsite, any risk of breakage onsite, or mismatching pieces is significantly reduced. Installers can approach vein matching projects with confidence while designers can execute complex schemes.

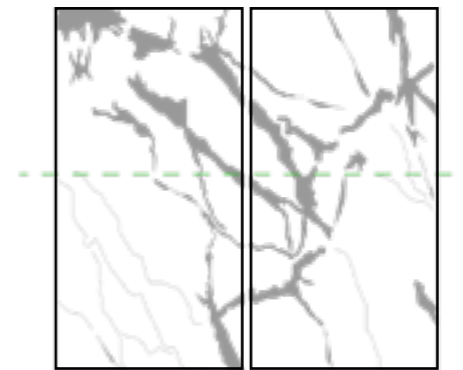

VEIN MATCHING (FIG.8.2)

*Please note that not all slabs are available with vein matching



VEIN MATCH FOR MAXIMUM IMPACT (FIG.9.1)



SEAMLESS PRECISION: BOOKMATCHED SLABS TRIMMED FOR FLAWLESS PATTERN ALIGNMENT (FIG.9.1)



3D CLADDING AND PRE-CUT DECORATIVE BATONS USED TO ELEVATE RECEPTION AREA (FIG.10.1)



CUT-TO-SIZE UNITES SPLIT LEVELS, ISLAND, AND ARCHITRAVE (FIG.10.2)



WALL PANNELLING SUPPLIED PRE-CUT AND LABELLED (FIG. 11.1)



ELEGANCE IN CURVES: PRE-CUT CLADDING SHAPE A STUNNING, CURVED WALL (FIG. 11.2)



BEYOND STRAIGHT LINES: INFUSE MOVEMENT WITH CURVES IN FLOOR, WALL, AND COUNTER DESIGN (FIG.12.1)



CUT-TO-SIZE VEIN MATCHING PANELS CLADDED OVER RECTANGULAR COLUMN (FIG.13.1)



CUT-TO-SIZE VEIN MATCHING STRIPS CLADDED OVER CIRCULAR COLUMN (FIG.13.2)



ELEVATE HOSPITALITY WITH BESPOKE BAR, SHELVING, AND DOOR FRONTS (FIG.14.1)



CREATE SERENE ZONES WITH COORDINATED WALL PANELS AND INTEGRATED SHELVING UNIT (FIG.15.1)



THE APPEARANCE OF SPACE REALISED WITH POINT OF SALE DISPLAYS (FIG.16.1)



TABLETOP HARMONY WITH MATCHING WALL PANELS (FIG. 17.1)



UNIFY SPACES WITH A SINGLE SURFACE (FIG.18.1)



SIMPLE YET ORIGINAL FIREPLACE DESIGNS (FIG.19.1)



EVERY PIECE PRE-CUT AND LABELLED, GUIDED BY DETAILED DRAWINGS (FIG.19.2)



TECHNICAL INSTALLATION PLANS MEAN PROJECTS MATCH YOUR DESIGNS (FIG.19.3)



LARGE FORMAT INLAID FLOOR USING 3000 x 1500 mm SLABS (FIG.20.1)

BESPOKE FLOORING DESIGNS

Create unique and visually stunning flooring designs on a larger scale by leveraging the full size and aesthetic appeal of large format slabs. Longer runs provide a seamless design with fewer grout lines. With our cut-to-size services, you can experiment with geometric patterns and curves to create your own bespoke cosmati flooring designs. Suitable for large scale projects spanning several hundred square metres, to a single inlaid floor for an entrance lobby, designs can be created for any style, from contemporary to classical. Geometric designs can be used to create intricate patterns and shapes, while curved designs can help with spatial zoning.

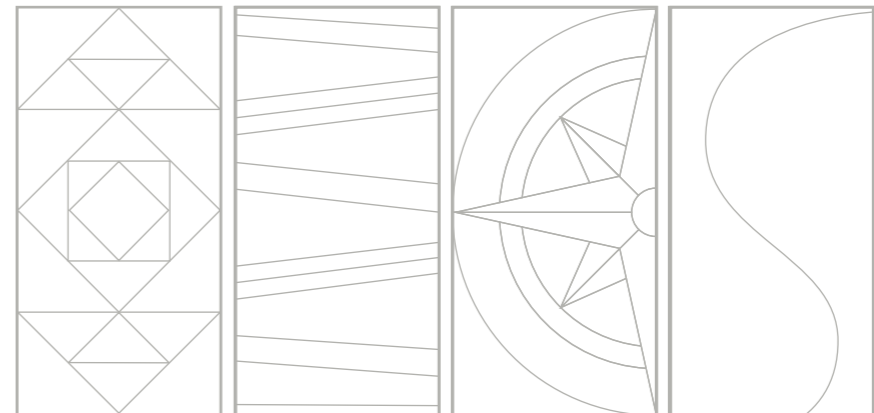

CLASSIC GEOMETRIC MODERN GEOMETRIC LARGE SCALE CURVE DESIGNS



PRE-CUT SLABS PROVIDE MAXIMUM FLOOR COVERAGE FOR LARGE SCALE PROJECTS (FIG.21.1)



LABELLED PRECISION CUT PIECES MAKE INSTALLATION EASY (FIG.21.2)



USE AS SPATIAL ZONING TO CREATE SUB-SPACES IN LARGER AREAS ACCORDING TO USAGE (FIG.22.1)



BESPOKE FLOORS BLEND GEOMETRIC SHAPES, COLOURS, AND TEXTURES (FIG.23.1)

THE PROCESS

Be bold, experiment and elevate your room with a custom designed inlaid porcelain floor. Incorporate larger single pieces up to 3000 x 1500 mm and choose from over one hundred colours, textures and styles of porcelain slabs.

Our team will work with you to create your flooring design, bringing your vision to life and elevating the beauty of your space. Your design will be prepared offsite at our UK manufacturing facility. It will be carefully packaged and supplied with technical drawings. All flooring is supplied with clear piece numbering, to ensure successful and reliable installation.

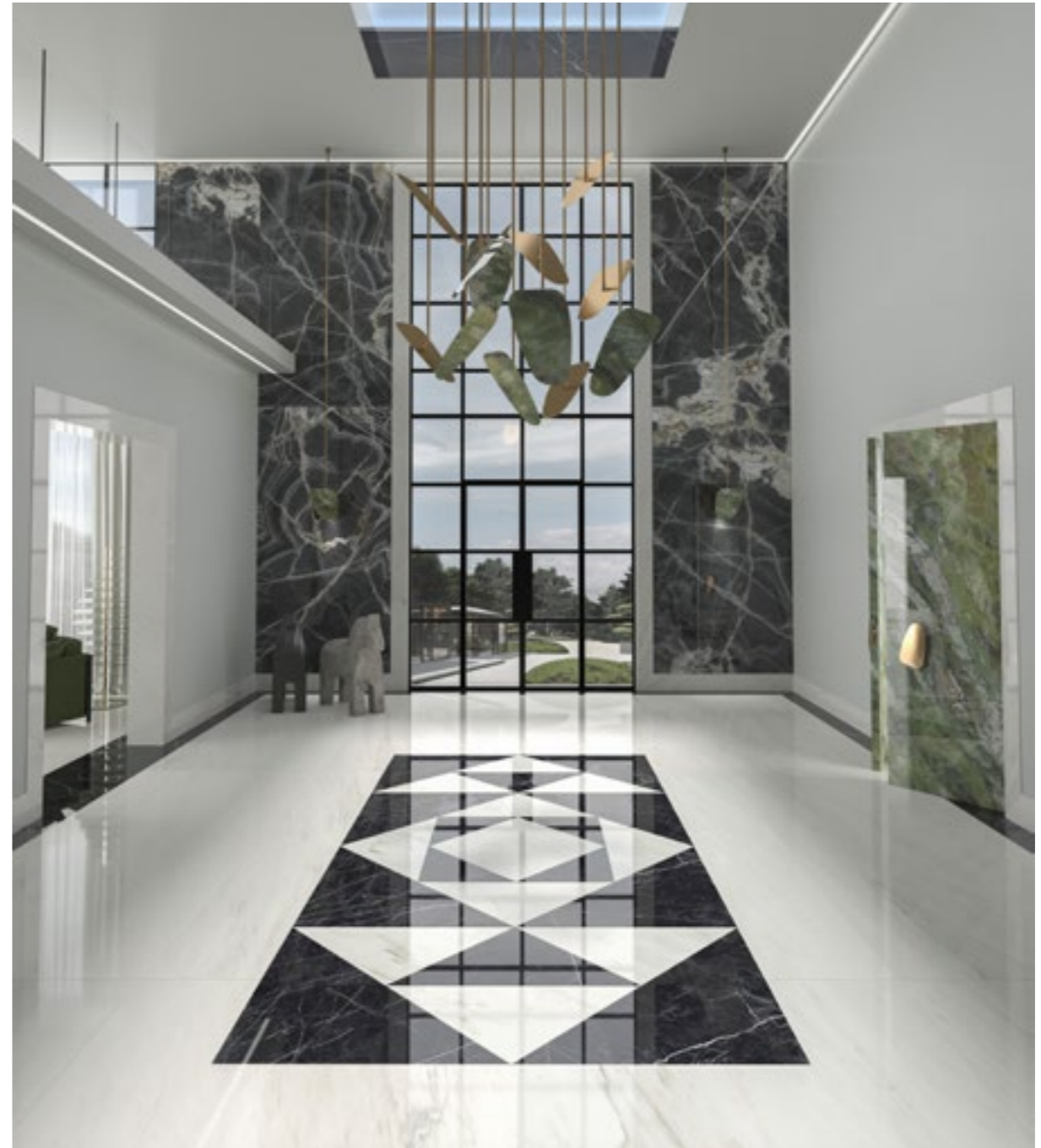

CREATE A UNIQUE FLOOR WITH GEOMETRIC SHAPES, VIBRANT COLOURS, AND DIVERSE TEXTURES (FIG.24.1)

FURNITURE INLAYS AND TOPS

Reimagine your cherished furniture pieces with the timeless allure and durability of a porcelain inlay or top. Upgrade your existing table tops and furniture inlays with precision cut-to-size porcelain surfaces, made possible by our advanced CNC cutting technology. We can accommodate any shape, including ovals, irregular shapes, or rectangles, and provide square or curved corners to your exact specification or technical drawings.

Request circular diameters up to 1500 mm or rectangular pieces up to 3000 mm in length, while you can choose from over a hundred colours and textures, with an edge profile suitable for your needs.

The use of a porcelain inlay within existing furniture is both an elegant, cost effective and practical choice, offering beautiful variations of colour, style and texture. Porcelain also provides a durable and waterproof surface that is easy to maintain and suitable for hospitality and commercial remodelling projects.



ELEVATE YOUR DESK WITH A PRECISION-CUT PORCELAIN INLAY (FIG.25.1)



CIRCLE OF ELEGANCE: REIMAGINE SIDE TABLES WITH CHIC CIRCULAR PORCELAIN INLAYS (FIG.26.1)



UPDATE CONSOLES WITH REPLACEMENT TOPS THAT SEAMLESSLY MATCH YOUR WALLS (FIG.26.2)



CUSTOM SHAPE TABLE TOP TO FIT DESIGN AND SPACE REQUIREMENTS (FIG.27.1)



REMODEL EXISTING TABLES WITH PRECISION CUT PORCELAIN TOPS (FIG.27.2)



REVITALIZE YOUR SEATING AREA WITH FRESH PORCELAIN TABLE TOPS (FIG.28.1)

3D CLADDING APPLICATIONS

Through the cut-to-size service, we are able to supply pre-prepared 3D cladding for a whole host of practical, artistic and time-saving applications. We meticulously label each piece and provide precision cut mitred edges for effortless installation. Employing pre-cut cladding streamlines the fabrication process, resulting in significant cost and time savings onsite.

3D cladding solutions can be used for residential projects both indoors and out, and for a host of retail and hospitality applications including plinths, planters, display stands, seating and customer service counters.

Architects can also exploit the beauty and practicality of porcelain slabs to explore every facet of stair design including steps, treads, nosing, risers and handrails.



TRANSFORM YOUR SURFACES WITH SEAMLESS 3D CLADDING (FIG.29.1)



RETAIL DISPLAY AND PLINTHS (FIG.30.1)



VEIN MATCHED CLADDING WITH PRE-CUT MITRES ELEVATES RETAIL DISPLAYS (FIG.30.2)



MAKE A STATEMENT WITH A UNIQUE TABLE DESIGN (FIG.31.1)



CAPTIVATING BEAUTY COUNTER AND MATCHING SIDE TABLE (FIG.31.2)



FIRST IMPRESSIONS MATTER FOR THIS STUNNING RECEPTION COUNTER (FIG.32.1)



SEAMLESS STORAGE AND MATCHING SHELVING REDEFINES RETAIL DISPLAY (FIG.33.1)



SPA AMBIANCE ELEVATED WITH BESPOKE VANITY, CLADDLED DISPLAYS, AND ARCHITECTURAL FINERY (FIG.33.2)



MODERN AESTHETIC THROUGH CANTILEVER STAIRCASE WITH PORCELAIN TREADS (FIG.34.1)

STAIRCASE, STEPS AND TREADS

Contemporary staircase design embraces clean lines and innovative materials. Through our cut-to-size services architects and designers can now exploit the beauty and practicality of porcelain slabs to explore every facet of stair design including steps, treads, nosing, risers and handrails. We provide solutions for commercial and residential projects, and offer surfaces that are suitable for both internal and external spaces.

Use cut-to-size for projects of any scale, from a single step within a split-level scheme, to a full stairwell design, while our expertise and support ensure that your project is completed on-time and on-budget. Both cladded treads and profile edge steps are possible and all can be supplied with matching skirting and wall tiles. For accurate specification we recommend our onsite laser templating service to ensure the precision and fit of every step.



20MM STEPS FEATURING BULLNOSE PROFILE AND ANTI-SLIP GROOVES (FIG.35.1)



FLOATING CANTILEVER STAIRCASE WITH SLEEK PORCELAIN TREADS (FIG.36.1)



LASER TEMPLATING ENSURES PERFECTLY FITMENT. SHOWN WITH CUSTOM PLANTERS (FIG.36.2)



LARGE FORMAT FLOOR SLABS WITH MATCHING 12 MM STEPS WITH BULLNOSE NOSING (FIG.37.1)

TREAD AND NOSING PROFILES

Our steps and treads service provides a comprehensive solution for clients seeking bespoke steps, treads, and risers. We offer full laser templating to ensure accurate fitment and a smooth installation. All staircase projects are manufactured in the UK, which translates into a hassle-free process and reliable lead times.

On the following page you will find a selection of available nosing profiles, suitable for internal and external applications. All steps are available in 12 mm and 20 mm thicknesses and can be supplied with matching risers. External steps use 20 mm formats with a Grip finish. Options are also available for configuring anti-slip grooves and pre-installed channels ready for LED strip lighting (not supplied).



12 mm BULLNOSE NOSING WITH ANTI-SLIP GROOVES (FIG.38.1)



BULLNOSE



HALF BULLNOSE



POLISHED STRAIGHT EDGE



L SHAPE HALF BULLNOSE (includes riser)



DOUBLE HALF BULLNOSE



DOUBLE HALF BULLNOSE W/RISER



MITRED APRON W/SHADOW GAP



MITRED APRON W/LED CHANNEL

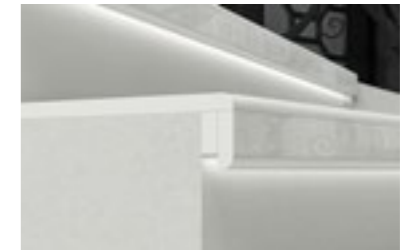

DOUBLE HALF BULLNOSE W/LED CHANNEL



L SHAPE MITRED APRON (includes riser)*



MITRED APRON RETURN*

All steps are available in 12 mm and 20 mm thicknesses.
*L Shape Mitre and Mitred Apron Return steps are also available in 6 mm thickness.



SUSPENDED ELEGANCE: CANTILEVER STAIRCASE WITH PORCELAIN TREADS (FIG.39.1)



NO DISCOLOURATION OR FROST DAMAGE, PORCELAIN SURFACES ARE DURABLE FOR ALL YEAR ROUND OUTDOOR USE (FIG.40.1)



CNC EDGE PROFILING (FIG.41.1)

EDGE PROFILING AND MITRES

Latest generation contouring machines prepare all profiling requests to exact specifications. Intricate cut-outs including circular, square or irregular shapes can be specified as well as decorative elements such as skirting and step tiles. We offer dependable lead times and execute all requests from within the UK.

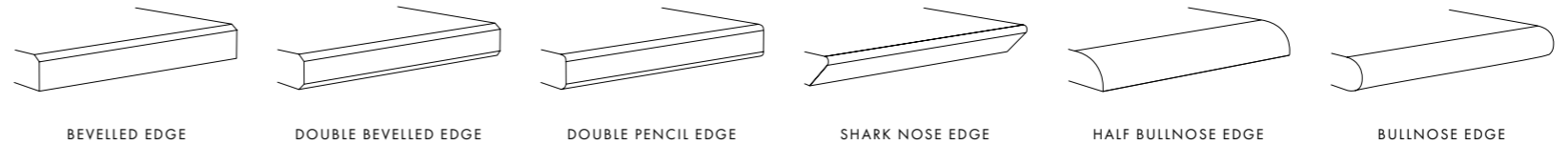

CLADDING PROFILES

Through the cut-to-size service, we provide cladding for a whole host of practical, aesthetic and time saving tasks. Supplied with carefully labelled, precision cut mitres, pre-cut cladding saves considerable time onsite, improving efficiency, reducing waste and the chance of damage. A laser templating service is also available for complex cladding projects.

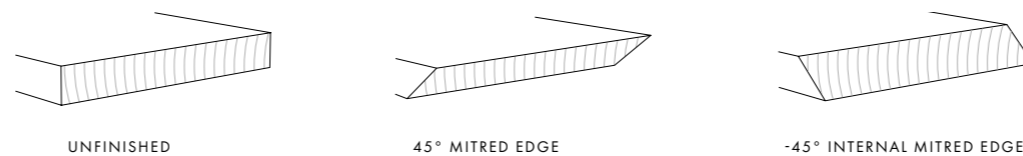

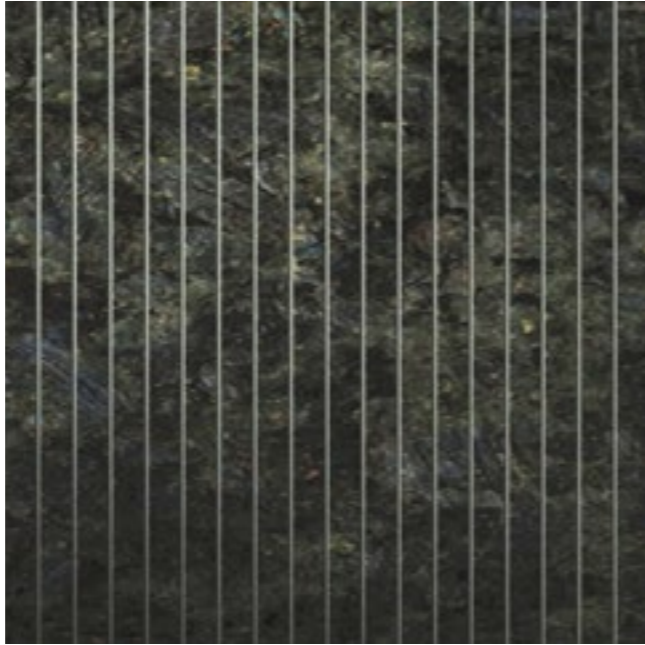

FLUTED DECOR (FIG.42.1)



STRIPS DECOR (FIG.42.2)

FLUTED DECOR

Fluted Decor can be incorporated into cut-to-size requests and is priced per square metre. Delicate grooves are cut into the material, creating a subtle contrast and variation to the surface design.

Fluted grooves are 2 mm in thickness and can be specified at 5 mm, 10 mm or 20 mm intervals and a vertical or horizontal direction.

STRIPS DECOR

Individually cut strips can be supplied in widths between 26 - 34 mm. Strips can be cut to clad flat or curved surfaces and applied to curved walls and pillars. Accurately angled mitred edges ensure a flush finish.

Each strip is carefully labelled to simplify the installation process and ensure the veining and pattern matching continues across surfaces to be cladded.

EXPANDING IDEAS: CUCINA COLLECTION



ISLAND LIFE: ELEVATING
YOUR KITCHEN WITH FUNCTIONAL
AND STYLISH ISLANDS

(FIG.44.1)



(FIG. 45.1)

PROJECT_01: KITCHEN ISLAND

An island that enhances the overall functionality and aesthetic appeal. Designers choose colour, size, finish and vein matching options. Designed to be installed over a base or existing cabinetry (not included). Specify the top, sides, front and back for a homogeneous or contrasting look. Cabinet doors can be cladded and islands can be specified with an overhang of up to 400 mm for additional seating. Precision is key, as laser templating is used to accurately position cut-outs for the hob, sink, and electrical sockets. All panels come together seamlessly with 90° mitred joints. The cost of the kitchen island is calculated per square meter, plus front and rear panels. Laser templating and full delivery and installation services available.

ISLAND SPECIFICATION

Length (L)	3200 mm
Depth (D)	1200 mm
Height (H)	900 mm
Downstand thickness (T)	60 mm mitred apron return at 90°
Front/Rear panels	Matching rear panel
Cabinet doors	Cladded cabinet door
Configurable options	Hob and sink cut-out
Note	Base unit and cabinetry not supplied
Surface	Pietra Piasentina - Structured



(FIG.46.1)

PROJECT_01 PALETTE



PIETRA PIASENTINA
STRUCTURED
3000 x 1500 mm
6 mm THICKNESS



EMINENT BROWN
SILK
3000 x 1500 mm
6 mm THICKNESS



CANALETTO
NATURAL
1500 x 750 mm
10 mm THICKNESS

ISLAND TECHNICAL DATA SHEET

Length (L)	∞ (Max 3000 mm without a join)*
Depth (D)	∞ (Max 3000 mm without a join)*
Height (H)	[900 mm][Custom height]
Downstand thickness (T)	40 - 100 mm
Approximate weight	26 kg per m ²
Front/Rear panels	[Rear][Front]
Overhang (with/without cut-out)	[200 mm with cut-out][400 mm without cut-out]
Cladded cabinet doors	[Not required][Required]
Configurable options	Options include hob/sink cut-outs & tap holes
Note	Design fee applicable. Kitchen base unit and cabinetry not supplied.

* Dependant on vein matching and top thickness.



THE ULTIMATE GATHERING SPOT:
WATERFALL ISLANDS THAT BRING
FAMILY AND FRIENDS TOGETHER

(FIG. 48.1)



(FIG.49.1)

PROJECT_02: ISLAND WATERFALL

An island waterfall that offers versatility and additional space for entertaining and dining. Specify as a stand-alone unit or attach to an existing structure. Comes with one or two sides to fit your installation needs. Each waterfall is fully clad with high-performing porcelain surface. Shown with a downstand thickness of 100 mm and front face angle of 45°. Cut-outs for hob and extractor with an integrated sink. Laser templating and full delivery and installation services are available.

WATERFALL SPECIFICATION

Length (L)	3600 mm
Depth (D)	1200 mm
Height (H)	910 mm
Downstand thickness (T)	100 mm with 45° decline front face
Sides	2 waterfall sides
Surface	Deep Norway - Polished
Note	Base unit and cabinetry not supplied
Configurable options	Integrated sink, hob and extractor cut-out and tap hole

TABLE SPECIFICATION

Length (L)	1800 mm
Depth (D)	900 mm
Height (H)	710 mm
Downstand thickness (T)	100 mm with 45° decline front face
Sides	1 waterfall side
Surface	Deep Norway - Polished



(FIG.50.1)

BREAKFAST BAR AND SHELVING

Available in lengths up to 3000 mm without a join, breakfast bars can be specified to match or contrast your colour scheme. Various sizes are available and a vertical or decline front face can be optioned to make sure all available space is maximised. Thickness between 40 and 100 mm are possible with each bar supplied with all necessary fixings. Kitchen shelves can also be designed to display favourite pieces of kitchenware.

BREAKFAST BAR SPECIFICATION

Length 2330 mm

Depth 400 mm

Thickness 80 mm

Dual surface Rovere Baio - Natural

Edge profile Mitred edge. All visible surfaces are finished, including the underside

SHELVING SPECIFICATION

Length 1440 mm

Depth 200 mm

Thickness 40 mm

Dual surface Rovere Baio - Natural

Edge profile Mitred edge. All visible surfaces are finished, including the underside



(FIG.51.1)

PROJECT_02 PALETTE



DEEP NORWAY
POLISHED
3000 x 1500 mm
6 mm THICKNESS



ROVERE BAIO
NATURAL
3200 x 1500 mm
12 mm THICKNESS



PATAGONIA
NATURAL
3000 x 1500 mm
6 mm THICKNESS



URBAN GREAT GRIGIO
NATURAL
3000 x 1000 mm
6 mm THICKNESS



URBAN GREAT WHITE
NATURAL
3000 x 1000 mm
6 mm THICKNESS

WATERFALL TECHNICAL DATA SHEET

Length (L)	∞ (Max 3000 mm without a join)*
Depth (D)	∞ (Max 1500 mm without a join)*
Height (H)	[900 mm][Custom height]
Downstand thickness (T)	40 - 100 mm
Approximate weight	26 kg per m ²
Waterfall sides	[1][2]
Overhang	[200 mm with cut-out][400 mm without cut-out]
Edge profile	Mitred edge. All visible surfaces are finished
Configurable options	Configurable options include cut-outs for hob, sink and electrical sockets
Note	Design fee applicable. Kitchen base unit and cabinetry not supplied

BREAKFAST BAR TECHNICAL DATA SHEET

Length	∞ (Max 3000 mm without a join)*
Depth	200 to 600 mm
Thickness	40 to 100 mm
Approximate weight	25 kg per linear metre

FRONT FACE CONFIGURATION

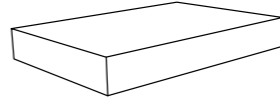
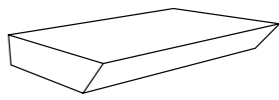
Front face	[Vertical]	[Decline]
		
Front face angle	[90°]	[45°]

* Dependant on vein matching and top thickness.

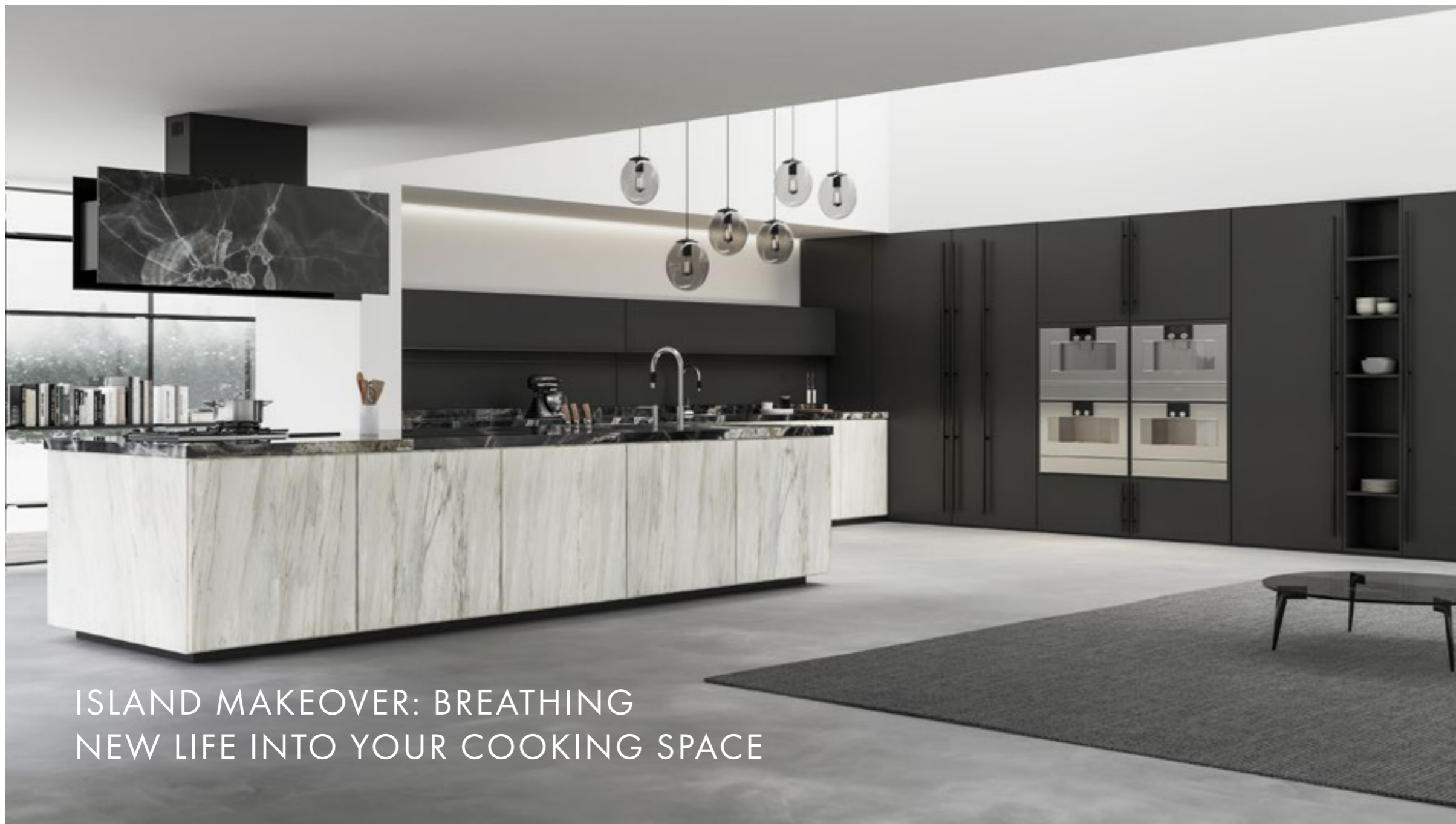

ISLAND MAKEOVER: BREATHING
NEW LIFE INTO YOUR COOKING SPACE

(FIG.53.1)



(FIG.54.1)

PROJECT_03: ISLAND COUNTERTOP

With the widest range of colours and designs on the market, you are sure to find the perfect porcelain countertop to match your kitchen. 50 mm thickness island countertop, designed to be installed over cabinetry or above an existing island (not supplied). This top is supplied with all visible surfaces clad with the chosen colour and carefully considered pattern/vein matching. Uninterrupted lengths up to 3000 mm and widths of 1500 mm are manufactured without a join this countertop has one join. Laser templating ensures that cut-outs for sink, hob, taps and electrical sockets are accurately positioned. Finally an overhang of up to 400 mm can be specified for occasional seating. Laser templating and full delivery and installation services are available.

ISLAND COUNTERTOP SPECIFICATION

Length (L)	4000 mm
Depth (D)	1250 mm
Height (H)	900 mm
Surface	Onice Nero - Polished
Downstand thickness (T)	50 mm with mitred apron return
Configurable options	Hob and sink cut-out



(FIG.55.1)

PROJECT_03: STANDARD COUNTERTOP

A standard countertop to revitalise an existing kitchen. Specified here with a 50 mm downstand to match the island. Install above kitchen units (not supplied) with a depth of 650 mm and against a rear wall. Lengths up to 3000 mm will be supplied without a join, while longer lengths like the 4800 mm shown here, will display a join. Countertop features a mitred apron return front edge with a 60 mm upstand to protect the wall from spills. Sides can also be finished to match the front. Cut-out for undermounted sink and single tap hole. Laser templating and full delivery and installation services available.

STANDARD COUNTERTOP SPECIFICATION

Length (L)	4800 mm
Depth (D)	650 mm
Downstand thickness (T)	50 mm
Surface	Onice Nero - Polished
Front edge	Mitred apron return
Configurable options	Sink cut-out and 60 mm upstand



(FIG.56.1)

PROJECT_03 PALETTE

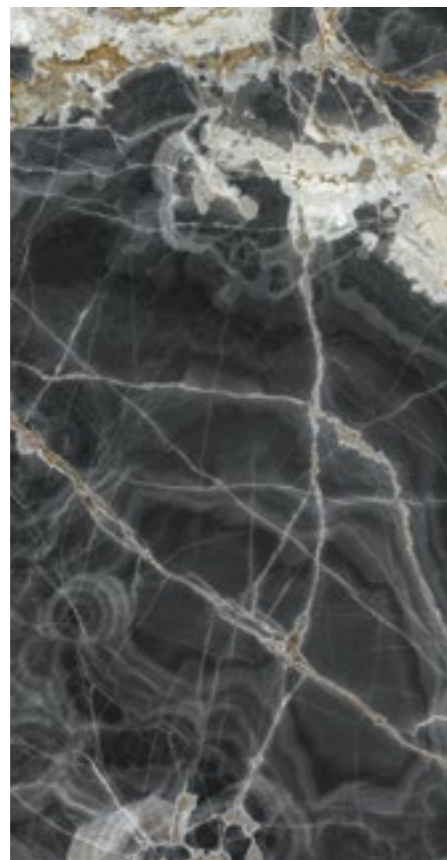

ONICE NERO
POLISHED
3000 x 1500 mm
6 mm THICKNESS



CREMA DELICATO
POLISHED
3000 x 1500 mm
6 mm THICKNESS

COUNTERTOP DATA SHEET

Length (L)	∞ (Max 3000 mm without a join)*
Depth (D)	∞ (Max 1500 mm without a join)*
Downstand thickness (T)	40 - 100 mm
Approximate weight	26 kg per m ²
Configurable options	Options including cut-outs & integrated sink
Edge profiles	Standard countertop is supplied with Mitred Apron Return.
Overhang	[200 mm with cut-out][400 mm without cut-out]
Note	Design fee applicable. Kitchen base unit and cabinetry not supplied
Downstand profile	[Mitred Apron Return]

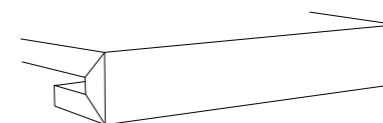

* Dependant on vein matching and top thickness.



THE HEART OF THE HOME:
THE IMPORTANCE OF A
WELL-DESIGNED KITCHEN

(FIG.58.1)



(FIG.59.1)

PROJECT_04: ISLAND COUNTERTOP

20 mm thickness island countertops can be customised with a choice of six stylish edge profiles. With improved structural strength and exceptional resistance to heat and scratches, 20 mm porcelain countertops are laser-templated and pre-cut ready for sinks and appliances. Specify in uninterrupted lengths up to 3200 mm and depths up to 1500 mm.

ISLAND SPECIFICATION

Length (L)	3000 mm
Depth (D)	700 mm
Thickness (T)	20 mm
Surface	Kuroka 4D - Polished
Approximate weight	45 kg per m ²
Edge profile	Double bevel
Configurable options	Sink and tap cut-out

BREAKFAST BAR SPECIFICATION

Length (L shape)	4200 mm plus 1100 mm
Depth	400 mm
Thickness	100 mm
Surface	Rovere Baio - Natural
Edge profile	Mitred edge. All visible surfaces are finished



(FIG.60.1)

PROJECT_04: STANDARD COUNTERTOP WITH SPLASHBACK

Experience unparalleled durability with our 20 mm thickness porcelain countertops. With superior heat and blade resistance, 20 mm countertops will maintain their perfect appearance, without fading or deteriorating over time and are laser templated and precision-cut to exact specifications. Experience the ultimate kitchen work surface with a 20 mm porcelain countertop.

STANDARD COUNTERTOP SPECIFICATION

Length (L)	3000 mm
Depth (D)	650 mm
Thickness (T)	20 mm
Surface	Kuroka 4D - Polished
Edge profile	Double bevelled
Configurable options	Hob cut-out

SPLASHBACK SPECIFICATION

Type	Standard Splashback
Length (L)	3000 mm
Height (H)	650 mm
Surface	Tropical Black - Polished (6 mm thickness)

PROJECT PALETTE_04

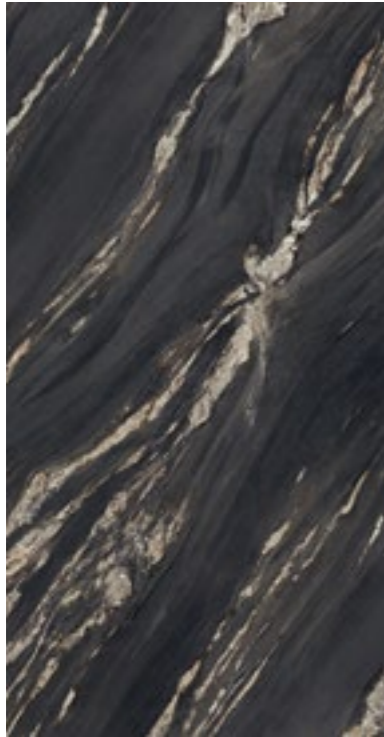

KUROKA 4D
POLISHED
3200 x 1600 mm
20 mm THICKNESS

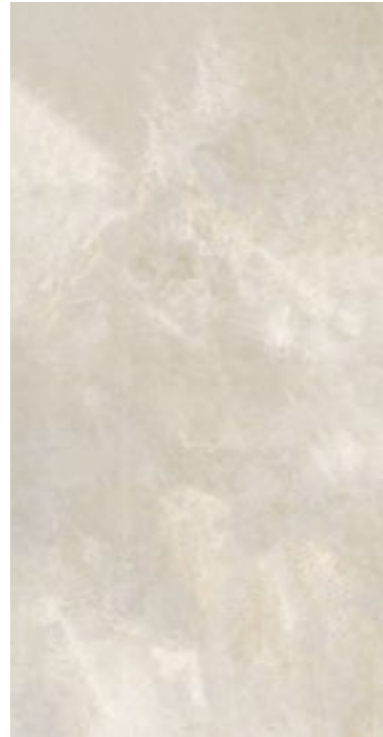

WHITE AION
NATURAL
3000 x 1500 mm
6 mm THICKNESS



ROVERE BAIO
NATURAL
3200 x 1500 mm
12 mm THICKNESS

20 MM ISLAND COUNTERTOP TECHNICAL DATA SHEET

Length (L)	∞ (Max 3200 mm without a join)
Depth (D)	∞ (Max 1500 mm without a join)
Thickness (T)	20 mm
Approximate weight	45 kg per m ²
Overhang	[200 mm with cut-out][300 mm without cut-out]
Edge profile	See Countertop Profiles
Configurable options	Options for cut-outs, integrated sink and tap holes
Note	Design fee applicable. Kitchen base unit and cabinetry not supplied

BREAKFAST BAR TECHNICAL DATA SHEET

Length	∞ (Max 3000 mm without a join)*
Depth	200 to 600 mm
Thickness	40 to 100 mm
Approximate weight	28 kg per linear metre

SPLASHBACK SPECIFICATION

Type	[Standard][Upstand][Feature height]
Length (mm)	∞ (Max 3000 mm without a join)
Top edge profile	See Countertop Profiles
Approximate weight	14 kg per m ²

* Dependant on vein matching and top thickness.



THE TASTE OF LUXURY:
A KITCHEN ISLAND THAT
MAKES A STATEMENT

(FIG. 62.1)



(FIG.63.1)

PROJECT_05: ISLAND COUNTERTOP

Elevate your kitchen with a luxurious island, dressed with a precision cut 12 mm thickness porcelain countertop. Every island countertop is laser-templated and arrives pre-cut with accurate cut-outs for taps and flush-mounted hobs and sinks. Choose from the widest selection of colours and styles and specify a stylish edge profile to personalise your design. Available in 3200 mm lengths without a join, with a maximum depth of 1500 mm. For larger dimensions, a panel join may be necessary.

SPECIFICATION

Length (L)	3030 mm
Depth (D)	1260 mm
Thickness (T)	12 mm
Surface	Pietra Grey - Polished
Edge profile	Shark-nose
Configurable options	Hob, sink and drainer cut-outs



(FIG.64.1)

PROJECT_05 PALETTE



PIETRA GREY
POLISHED
3200 x 1500 mm
12 mm THICKNESS



ALASKA WHITE
NATURAL
3000 x 1500 mm
6 mm THICKNESS



JATOBA BROWN
SILK
3000 x 1500 mm
6 mm THICKNESS

12 MM THICKNESS ISLAND COUNTERTOP DATA SHEET

Length (L)	∞ (Max 3200 mm without a join)
Depth (D)	∞ (Max 1500 mm without a join)
Thickness (T)	12 mm
Approximate weight	29 kg per m ²
Overhang	[90 mm with cut-out][200 mm without cut-out]
Edge profile	See Countertop Profiles
Configurable options	Options for cut-outs, integrated sink and tap holes.
Note	Design fee applicable. Kitchen base unit and cabinetry not supplied

* Dependant on vein matching and top thickness.



MULTITASKING AT ITS FINEST:
PORCELAIN COUNTERTOPS THAT
WORK HARD AND LOOK GOOD

(FIG.66.1)



(FIG. 67.1)

PROJECT_06: 12MM COUNTERTOP

12 mm thickness standard countertops are manufactured with a choice of six hard wearing edge profiles. With enhanced structural strength and superior heat and blade resistance each solid top is laser templated and arrives pre-cut with accurate hob and sink cut-outs. All colours are available in 3000 mm lengths and custom widths, meaning minimal joins and no limits.

STANDARD COUNTERTOP SPECIFICATION

Length (L)	2400 mm
Depth (D)	650 mm
Thickness (T)	12 mm
Surface	Plimawhite/01 - Natural
Edge profile	Double bevel
Configurable options	Integrated sink and splashback

ISLAND COUNTERTOP SPECIFICATION

Length (L)	2600 mm
Depth (D)	100 mm
Thickness (T)	12 mm
Surface	Plimawhite/01 - Natural
Edge profile	Double bevel

PROJECT PALETTE_06



PLIMAWHITE/01
 NATURAL
 3200 x 1600 mm
 12 mm THICKNESS

12 MM THICKNESS ISLAND COUNTERTOP DATA SHEET

Length (L)	∞ (Max 3200 mm without a join)
Depth (D)	∞ (Max 1600 mm without a join)
Thickness (T)	12 mm
Approximate weight	29 kg per m ²
Overhang	[90 mm with cut-out][200 mm without cut-out]
Edge profile	See Countertop Profiles
Configurable options	Options for cut-outs, integrated sink and tap holes
Note	Design fee applicable. Kitchen base unit and cabinetry not supplied



PLAYING TO THE GALLERY:
ISLANDS AND COUNTERTOPS
THAT MAKE A STATEMENT

(FIG.69.1)



(FIG.70.1)

PROJECT_07: ISLAND COUNTERTOP

The heat and scratch-resistant properties of porcelain countertops make them a practical and low-maintenance option for busy kitchens. The luxurious and opulent appearance of this Arabescato top adds a touch of refined style to any space, making it a popular choice among homeowners and interior designers alike. Shown with 40 mm thickness downstand with vein matching and integrated sink.

ISLAND SPECIFICATION

Length (L)	2000 mm
Depth (D)	1200 mm
Downstand thickness (T)	40 mm
Surface	Arabescato - Polished
Edge	Mitred apron return
Configurable options	Integrated sink, hob and tap hole



(FIG.71.1)

PROJECT_07: STANDARD COUNTERTOP

Extending this stunning surface as a standard countertop above cabinets creates a seamless transition between food preparation and socialising, elevating the aesthetic and overall enjoyment of the space. Shown with 40 mm thickness downstand, 60 mm upstand and integrated sink.

STANDARD COUNTERTOP SPECIFICATION

Length (L)	3700 mm
Depth (D)	650 mm
Downstand thickness (T)	40 mm
Surface	Arabescato - Polished
Front edge	Mitred apron return
Configurable options	Integrated sink, tap hole and 60 mm upstand

PROJECT PALETTE_07



ARABESCATO
POLISHED
3000 x 1500 mm
6 mm THICKNESS

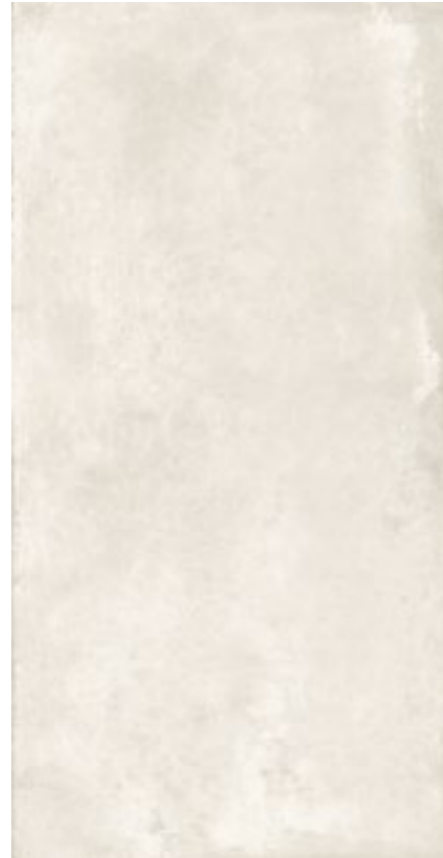

TALC
NATURAL
3000 x 1500 mm
6 mm THICKNESS

COUNTERTOP DATA SHEET

Length (L)	∞ (Max 3000 mm without a join)*
Depth (D)	∞ (Max 1500 mm without a join)*
Downstand thickness (T)	40 - 100 mm
Overhang	[200 mm with cut-out][400 mm without cut-out]
Approximate weight	26 kg per m ²
Configurable options	Options including cut-outs & integrated sinks
Note	Design fee applicable. Kitchen base unit and cabinetry not supplied
Edge profiles	Standard countertop is supplied with Mitred Apron Return.
Downstand profile	[Mitred Apron Return]

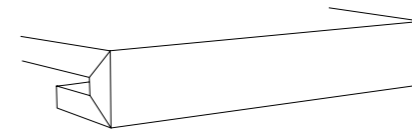

* Dependant on vein matching and top thickness.



12 mm COUNTERTOP PROFILES (FIG.73.1)

COUNTERTOP PROFILES

Kitchen worktops are constantly exposed to potential scratches from sharp or pointed tools, and it is under these intensive conditions that high-performance porcelain slabs excel, exhibiting one of the hardest surfaces available on the market.

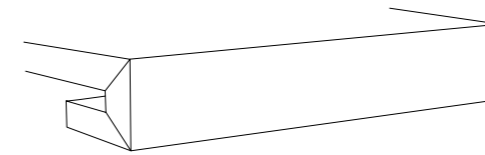

MITRED APRON RETURN
(downstand thickness 40 - 100 mm)

12 mm and 20 mm thickness countertops can be supplied with one of the following edge profiles:

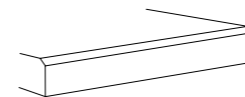

BEVELLED EDGE

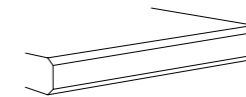

DOUBLE BEVELLED EDGE

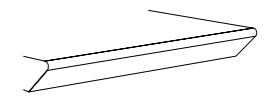

SHARK NOSE EDGE

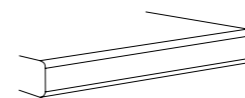

DOUBLE PENCIL EDGE

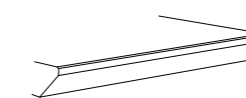

SHARP SHARK NOSE EDGE

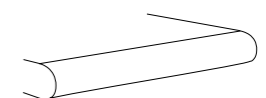

BULLNOSE EDGE



20 mm COUNTERTOP WITH SINK CUT-OUT (FIG.74.1)



20 mm COUNTERTOP INTEGRATED SINK AND DRAINER GROOVES (FIG.74.2)

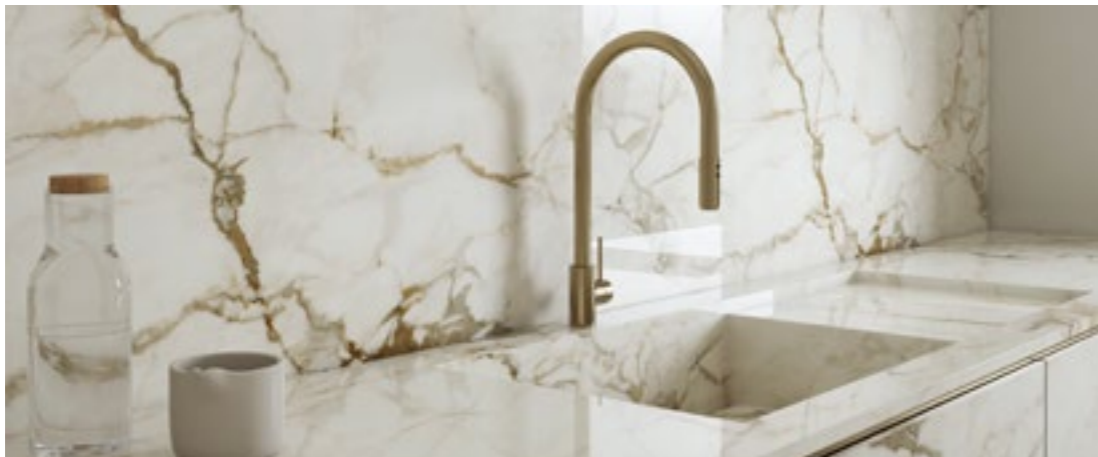

20 mm COUNTERTOP WITH INTEGRATED SINK AND DRAINER (FIG.74.3)

SURFACE SHOWN: CALACATTA MACCHIA VECCHIA 4D - POLISHED

CUT-OUTS & INTEGRATED SINK

Countertops can be specified with cut-outs for an under-mounted sink, flush-fitting hob and electrical or charging sockets. An integrated sink with drainer, which has all surfaces clad to match your work surface can also be specified. Vein matching is employed where panels meet to ensure the beauty of the surface design is maximised. And with laser templating service producing an extremely accurate worktop, costs associated with reworks are eliminated and time spent on installation is significantly reduced.

COUNTERTOP OPTIONS

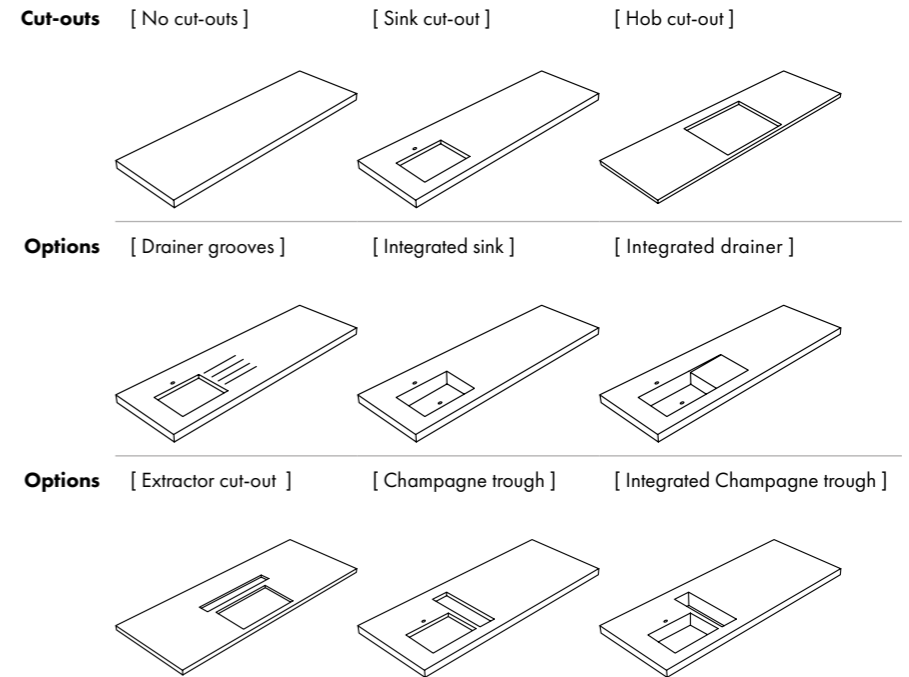



SPLASHBACK (FIG.75.1)

SPLASHBACKS & UPSTANDS

Our luxury porcelain kitchen splashbacks are the epitome of sophistication and style, adding a touch of elegance to any kitchen while providing a durable and low-maintenance solution for protecting your walls from spills and splatters. From simple 60 mm upstands to full height feature walls, a complementary splashback will enhance and complete every kitchen project. Splashbacks are precisely cut by CNC machine and are prepared with pre-cut holes for electrical and charging sockets or utilities. Choose a style to complement your countertop in uninterrupted lengths up to 3000 mm and heights from 60 mm to 1500 mm for standard runs, or taller up to 3 metres for feature walls.

SPECIFICATION

Type	[Standard][Upstand][Feature height]
Length (mm)	∞ (Max 3000 per run Lengths > 3000 mm will have a joint)
Approximate weight	14 kg per m ²



UPSTAND WITH VEIN MATCHING (FIG.76.1)



FEATURE HEIGHT SPLASHBACK (FIG.76.2)



ELLIPSE (FIG.77.1)



RECTANGULAR (FIG.77.2)







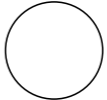
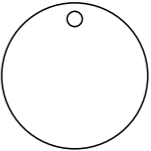

HEXAGON (FIG.77.3)

TABLEWARE

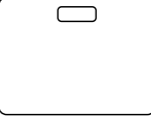
This serveware set injects a little luxury into your dining experience by providing a set of placemats and matching drink coasters plus a chopping board. Each item is elegantly shaped and cut from a large slab, making every piece unique. Finished to an extremely high standard with polished edges and a soft-touch, non-slip underside, each set provides the perfect accompaniment for fine dining. Choose from an array of colours.

SPECIFICATION

Model	Coaster	Placemat	Chopping Board	
Ellipse				
Rectangular				
Hexagon				
Min Quantity	4 Pieces	4 Pieces	1 Piece	
Tableware set	(4 coasters, 4 placemats, 1 chopping board)			
Dimensions (mm) (approximate)	Length (L):	100	320	400
	Depth (D):	100	240	300
Thickness	6 mm			
Bottom face	Rubber pad			

12 mm COUNTERTOP COLOURS



ARABESCATO
POLISHED | NATURAL



CALACATTA MACCHIA VECCHIA
POLISHED | SILK



MARBLE CAPRAIA
POLISHED | NATURAL



YAMUNA
POLISHED | NATURAL



PLATINUM WHITE
NATURAL



STONE MARFIL
NATURAL | POLISHED



FIOR DI BOSCO
POLISHED | SILK



STONE BROWN
NATURAL



STONE_01
NATURAL



BIANCO LASA
NATURAL | POLISHED



BIANCO LASA
NATURAL | POLISHED



SLATE GREY
NATURAL



MARBLE LAURENT
NATURAL | POLISHED



SAHARA NOIR
NATURAL | POLISHED



MOUNTAIN PEAK
NATURAL | POLISHED



RIVERBED
NATURAL | POLISHED

12 mm COUNTERTOP COLOURS

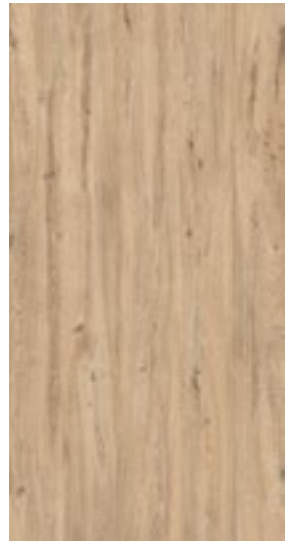

ROVERE BUCKSKIN
NATURAL

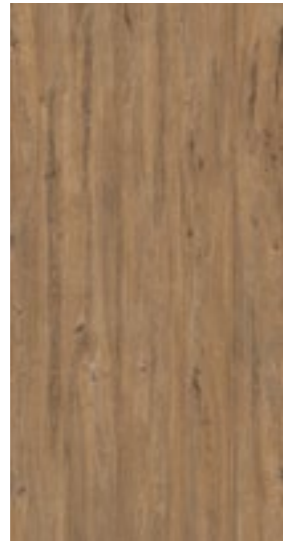

ROVERE BAIO
NATURAL



BLONDE OAK
NATURAL

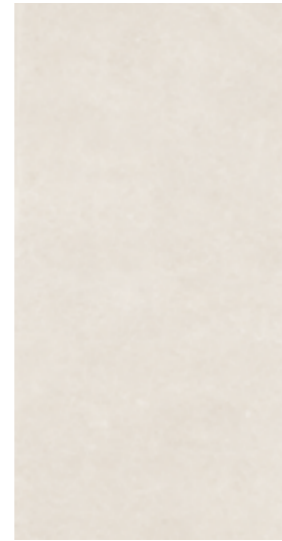

BORGOGNA
NATURAL



NOIR
NATURAL



BASALTO
NATURAL

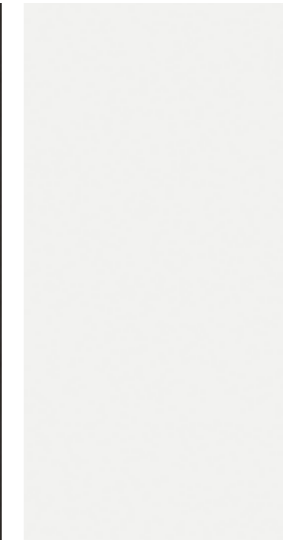

UNI ICE
NATURAL

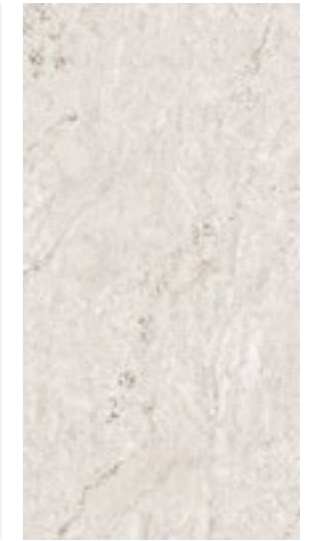

PLIMAWHITE/01
NATURAL

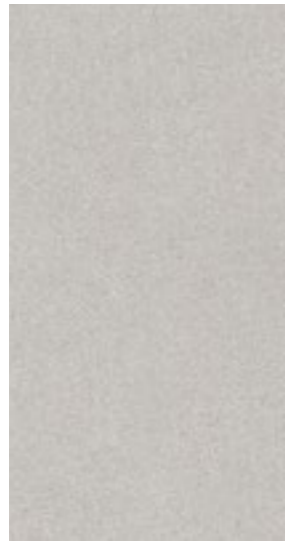

CANDIDO
NATURAL | POLISHED

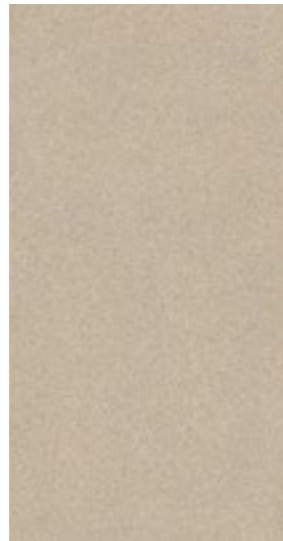

BEIGE
NATURAL | POLISHED



NERO
NATURAL | POLISHED



ALPINE BROWN
NATURAL



PIETRA GREY
POLISHED | NATURAL

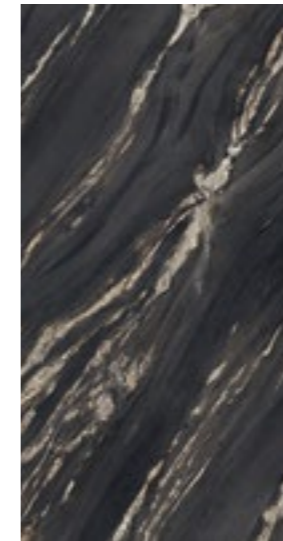

KUROKA
HONED

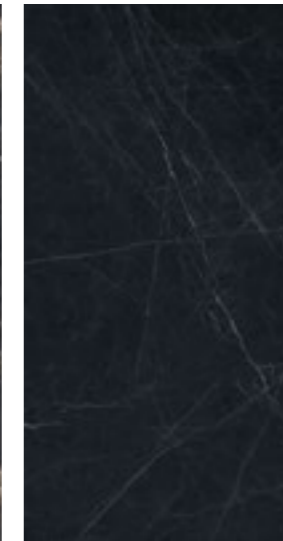

DARK MARQUINA
HONED | POLISHED

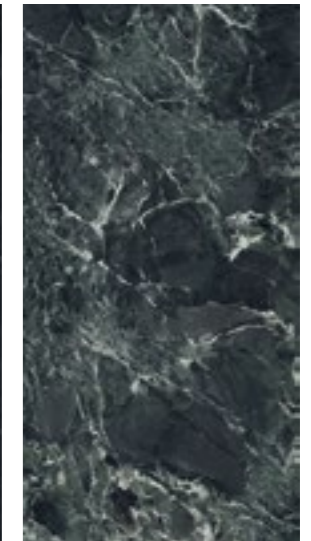

ALPI CHIARO VENATO
NATURAL

12 mm BOOKMATCHED COLOURS



TUNDRA BOOKMATCHED
POLISHED | NATURAL



CALACATTA PAONAZZO BOOKMATCHED
POLISHED

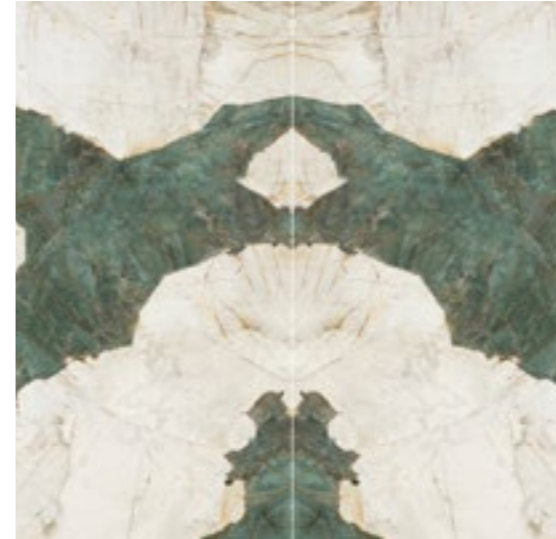

AQUA BOOKMATCHED
POLISHED | NATURAL



IRISH GREEN BOOKMATCHED
POLISHED



CALACATTA FOSSIL BOOKMATCHED
POLISHED | NATURAL



MACCHIA VECCHIA BOOKMATCHED
POLISHED | HONED



MARBLE CALACATTA GOLD BOOKMATCHED
POLISHED | NATURAL

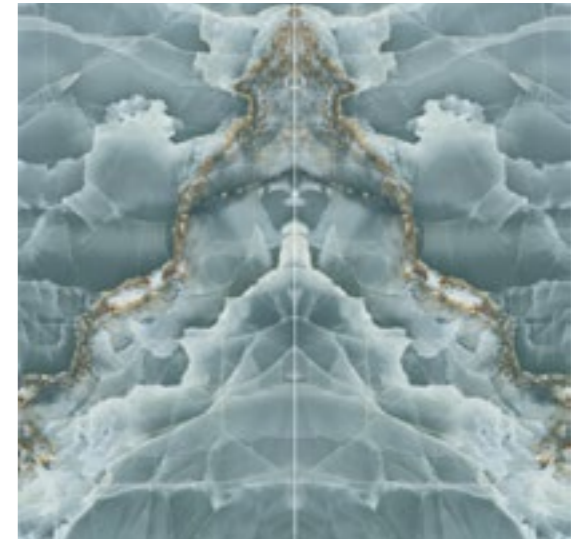

ONYX GREEN BOOKMATCHED
POLISHED

12 mm BOOKMATCHED COLOURS



LAGUNA BLANCA BOOKMATCHED
POLISHED



MOON GREY BOOKMATCHED
POLISHED | NATURAL



MARBLE CALACATTA BOOKMATCHED
POLISHED | NATURAL



SUPER WHITE BOOKMATCHED
POLISHED | NATURAL



LUMIX BOOKMATCHED
POLISHED | NATURAL



GRANITE STONE BOOKMATCHED
NATURAL



ETERNAL WHITE BOOKMATCHED
POLISHED | NATURAL



ETERNAL GOLD BOOKMATCHED
POLISHED | NATURAL

12 mm BOOKMATCHED COLOURS

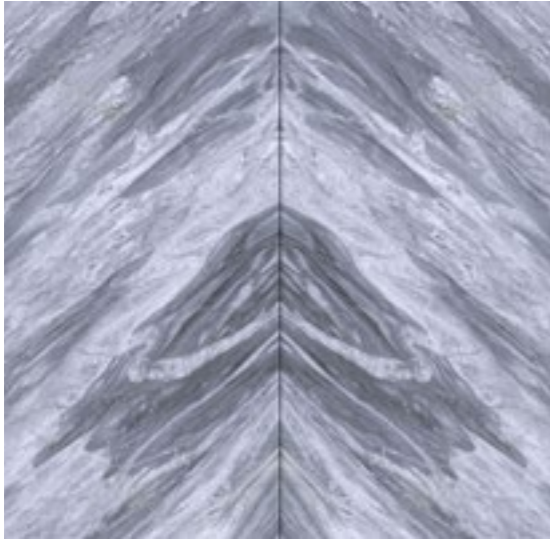

BORDIGLIO MANHATTAN BOOKMATCHED
POLISHED | NATURAL



GRANITO BLU ANDE BOOKMATCHED
POLISHED



AZURE BOOKMATCHED
POLISHED | NATURAL



INFINITA STONE BOOKMATCHED
HONED | NATURAL



ONYX BOOKMATCHED
POLISHED

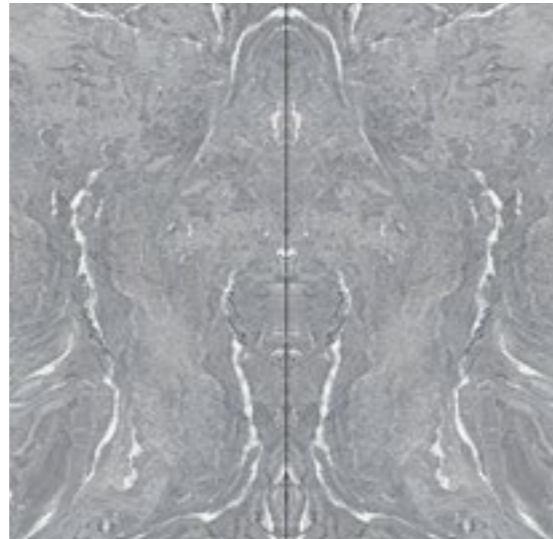

PIETRA DI VALS BOOKMATCHED
NATURAL

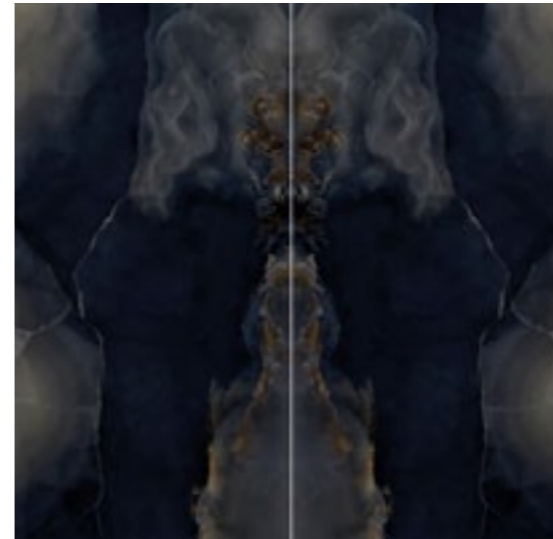

ONYX BLACK BOOKMATCHED
POLISHED



CALACATTA BLACK BOOKMATCHED
POLISHED | NATURAL

12 mm BOOKMATCHED COLOURS



MARBLE WHITE BOOKMATCHED
POLISHED | NATURAL

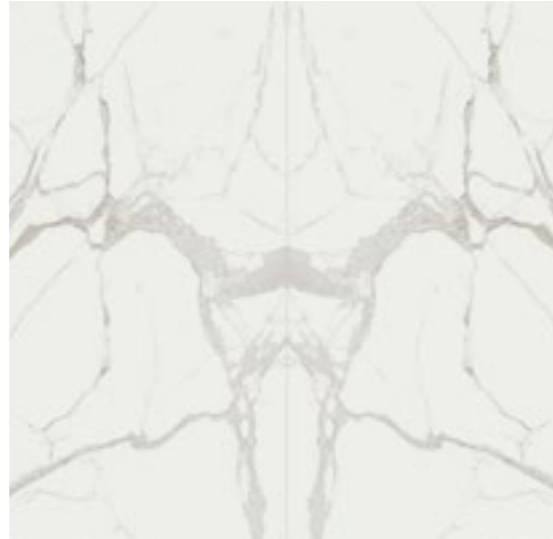

MARBLE STATUARIO BOOKMATCHED
POLISHED | NATURAL

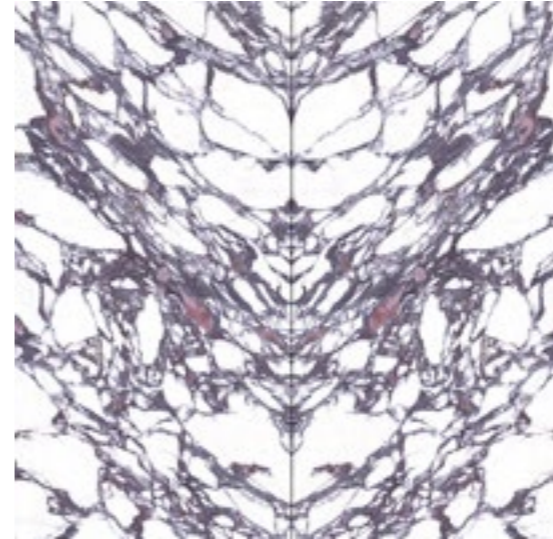

CALACATTA VIOLA BOOKMATCHED
POLISHED | NATURAL

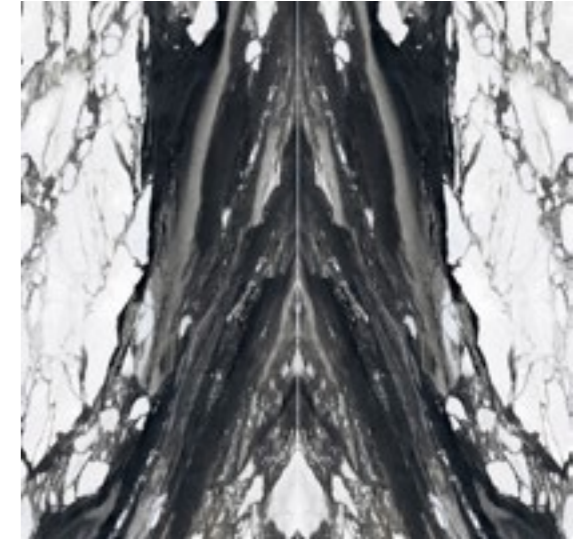

CALACATTA RENOIR BOOKMATCHED
POLISHED

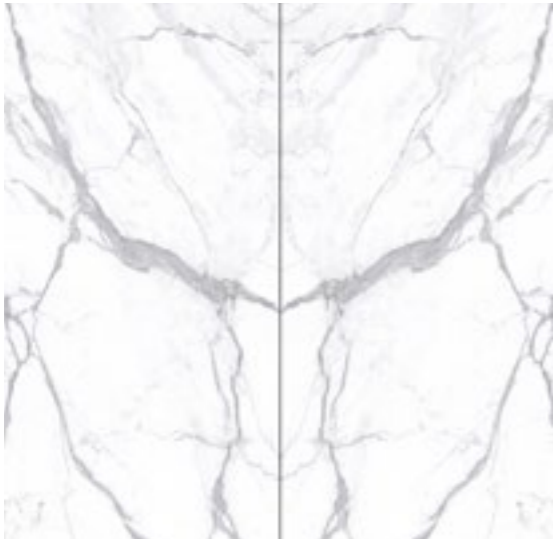

STATUARIO EXTRA BOOKMATCHED
POLISHED | HONED



MARBLE BREACH WHITE BOOKMATCHED
POLISHED | NATURAL

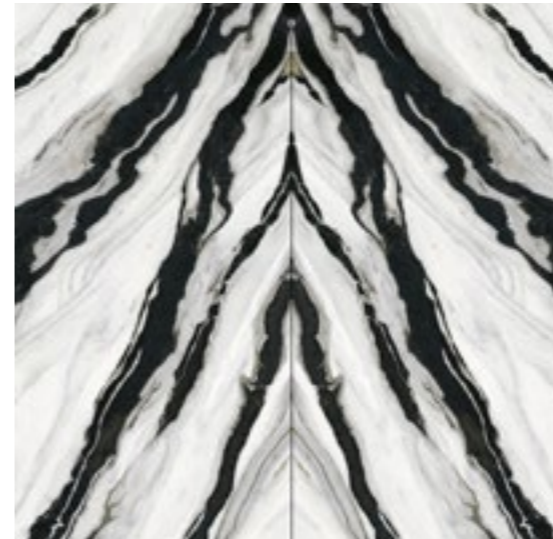

PANDA BOOKMATCHED
POLISHED | HONED



ARABESCATO CORCHIA BOOKMATCHED
POLISHED

12 mm BOOKMATCHED COLOURS

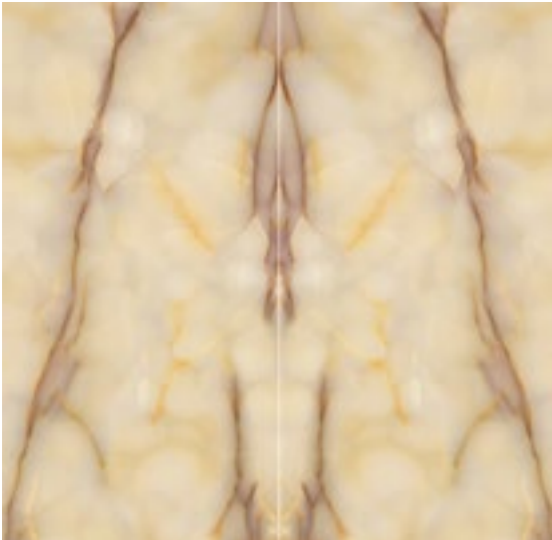

ONYX MIELE BOOKMATCHED
POLISHED | HONED



ONYX PERLA BOOKMATCHED
POLISHED | HONED



ONYX IVORY BOOKMATCHED
POLISHED



WHITE PARADISE BOOKMATCHED
POLISHED



THE PERFECT FINISH:
COMPLETING YOUR BATHROOM
WITH A STYLISH VANITY



EXPLORE THE WIDEST CHOICE OF MARBLE AND STONE DESIGNS (FIG.87.1)



BE BOLD WITH ON TREND COLOURS AND CONTRASTING SURFACES (FIG.87.2)



TRANSFORM YOUR SPACE WITH SLEEK WALL-MOUNTED VANITIES (FIG.88.1)



MAKE A STATEMENT WITH CAPTIVATING FLOOR-STANDING DESIGNS (FIG.88.2)



BATHROOM VANITIES AND BASINS DESIGNED FOR BOTH LARGE AND SMALL SPACES (FIG.89.1)



GEMINI 750 x 500 x 120 mm WITH FIXED BASE (FIG.90.1)



GEMINI WITH SLOPING BASE (FIG.90.2)

SURFACE SHOWN: FIOR DI BOSCO - POLISHED

GEMINI SURFACE-MOUNTED WASHBASIN

Gemini is a surface-mounted washbasin for installation over a vanity shelf or storage unit. Available in multiple sizes to meet your installation requirements, this basin can cater for both wall or surface-mounted tap systems. Configure Gemini with a fixed straight or sloping base.

SPECIFICATION

Model	Gemini
Dimensions (mm) (tolerance ± 2 mm)	Length (L): 450-1600 Height (H): 120-200 Depth (D): 400-650
Approximate weight	30 kg
Tap mounting position	[Wall-mounted] [Surface-mounted]
No. of pre-drilled tap holes	[] Please consult tap manufacturer's specification.



GEMINI WITH FIXED STRAIGHT BASE AND SURFACE-MOUNTED TAP (FIG.91.1)



GEMINI WITH SLOPING BASE AND WALL-MOUNTED TAP (FIG.91.2)



LIBRA 800 x 500 x 200 mm WITH WALL-MOUNTED TAP (FIG.92.1)



LIBRA WITH FIXED SLOPING BASE (FIG.92.2)

SURFACE SHOWN: FIOR DI BOSCO - POLISHED

LIBRA WALL-MOUNTED WASHBASIN

Libra is a diminutive wall-mounted washbasin with options for integrated storage. Ideal for washrooms where space is at a premium, Libra can be optioned with a single or double drawer, and fitted with premium push-to-open or soft-close runners. Specify your tap requirement and choose between a straight, sloping or removable sink base.

SPECIFICATION

Model	Libra
Dimensions (mm) (tolerance ±2 mm)	Length (L): 450-2600 Height (H): 120-200 or 300-700 w/storage Depth (D): 400-650
Approximate weight	30-50 kg
Tap mounting position	[Wall-mounted][Surface-mounted]
No. of pre-drilled tap holes	[] Please consult tap manufacturer's specification.



LIBRA 780 x 500 x 300 mm WITH SINGLE DRAWER (FIG.93.1)



LIBRA WITH SINGLE DRAWER AND REMOVABLE BASE (FIG.93.2)



LIBRA 1400 x 500 x 300 mm (FIG.94.1)

EXPERIMENTING WITH COLOUR

Terrazzo, renowned for its timeless charm, continues to be a beloved choice in many contemporary home designs. With its distinctive colour pigments and unique pattern, terrazzo provides a versatile surface that can serve as the canvas for your bathroom creativity. When paired with contrasting textures such as stone, brass, or leather, it creates a tactile environment that begs to be touched. Embrace the versatility and allure of terrazzo in your bathroom design and let your creativity run wild.



ALASKA WHITE
NATURAL



BELLINI
NATURAL



VERONESE
NATURAL



LIBRA 780 x 500 x 490 mm WITH DOUBLE STACKED DRAWER (FIG.95.1)

LIBRA STORAGE

Libra can also be optioned with a single or double stacked drawer to keep your essentials in order. By adding drawers you can turn Libra into a sleek and functional storage unit fitted with premium push-to-open or soft-close mechanisms.

CONFIGURATION

Storage Options [None] [Single Drawer] [Double Stacked Drawer]

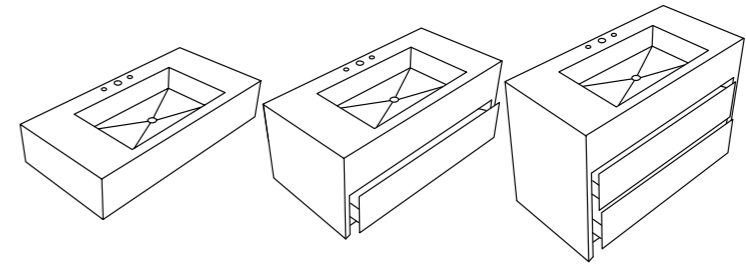

[None] [Double drawer] [Double shelf]

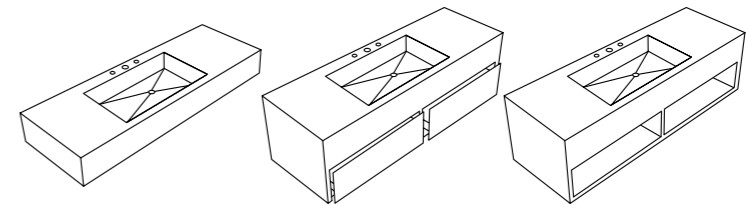

Base type [Fixed straight base] [Fixed sloping base] [Removable base]

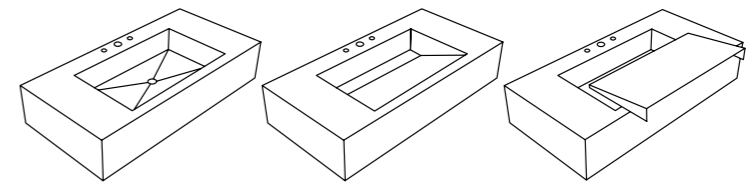

Waste [Chrome] [Black] [Brass] Hidden waste Hidden waste



LEO 2200 x 500 x 150 mm WITH FIXED SLOPING BASE (FIG.96.1)



LEO 2200 x 500 x 370 mm WITH TRIPLE DRAWER AND SIDE RECESS (FIG.96.2)

SURFACE SHOWN: FIOR DI BOSCO - POLISHED

LEO WALL-MOUNTED WASHBASIN

Leo is a stylish wall-mounted washbasin with a slimline 400 mm depth. Ideal for washrooms where space is limited but imagination is not, Leo underlines its flexibility with a host of storage options including integrated shelving and drawers. Use with a wall or surface-mounted tap system and configure the sink base to slope from the front or the side or choose a straight base with click-clack waste. See overleaf for Leo storage options.

SPECIFICATION

Model	Leo
Dimensions (mm) (tolerance ±2 mm)	Length (L): 1000-2600 Height (H): 120-300 or 350-500 w/storage Depth (D): 400-650
Approximate weight	40-50 kg

CONFIGURATION

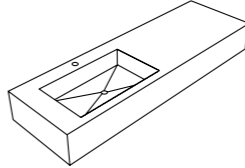
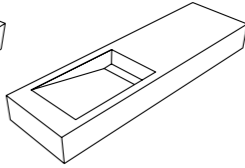
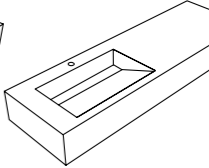
Base type	[Fixed straight]	[Fixed side sloping]	[Fixed front sloping]
			
Waste	[Chrome] [Black] [Brass]	Hidden waste	Hidden waste
Tap mounting position	[Wall-mounted] [Surface-mounted]		



LEO 1400 x 500 x 180 mm WITH MATCHING GLOBO AND 3D MIRROR (FIG.97.1)

EXPERIMENTING WITH COLOUR

A bold choice of feature wall provides a tone-on-tone colour palette, with large format slabs providing minimal grout lines and floor-to-ceiling panels. The shape grouping of the wall-mounted Leo basin, Globo storage unit, and 3D Mirror, feature tones from the palette and offers conformity without overwhelming the space. Exciting the senses are vertical veins which ally with the organic onyx-effect formations. The dark floor provides room for the concept to breathe. Embrace these enchanting surface colours in our bathroom product collection and let your creativity shine.



REVE JADE
POLISHED

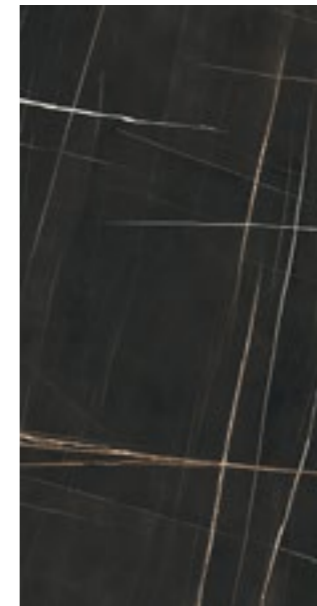

SAHARA NOIR
POLISHED



PLANK_06
NATURAL



LEO 1400 x 500 x 355 mm WITH DOUBLE DRAWER, SIDE SLOPING BASE (FIG.98.1)



LEO 2200 x 500 x 370 mm WITH TRIPLE DRAWER AND SIDE RECESS (FIG.98.2)

LEO STORAGE

Despite its slim profile, Leo can transform your bathroom into a clutter-free oasis by adding the optional drawers and shelves. With ample space for all your essentials Leo becomes a spacious and versatile vanity and storage unit. Single, double or triple arrangements can be catered for in any combination of drawer and shelf. Premium push-to-open runners continue the luxury feel. Leo can be specified with a single cavity for hand towels, storage buckets, laundry baskets or waste bins.

CONFIGURATION

Storage Options [Double Drawer] [Drawer & Shelf] [Double shelf]

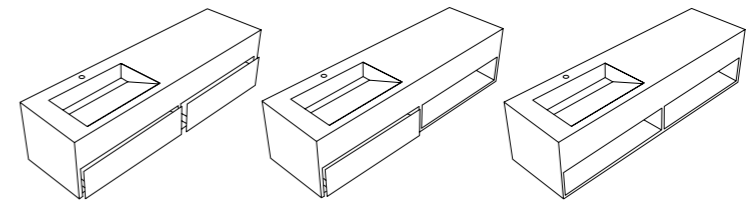

[Triple Drawer] [Triple shelf]

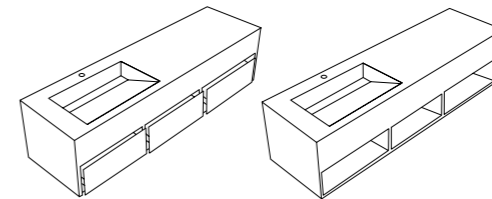

Cavity or Recess Leo can be specified with a recess suitable for storing hand towels and toiletries or a cavity / opening for storage buckets, laundry baskets or waste bins.

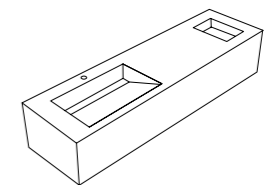



LEO 1400 x 500 x 355 mm WITH DRAWER AND SHELF (FIG.99.1)



LEO 2200 x 500 x 370 mm WITH DOUBLE SHELF (FIG.99.3)



LEO 1400 x 500 x 355 mm WITH DOUBLE DRAWER (FIG.99.2)



LEO 2200 x 500 x 370 mm WITH TRIPLE DRAWER AND SIDE RECESS (FIG.99.4)



CAPRICORN 2200 x 550 x 150 mm WITH FIXED STRAIGHT BASE (FIG.100.1)

CAPRICORN WALL-MOUNTED DOUBLE WASHBASIN

Capricorn is an opulent wall-mounted double washbasin available in lengths up to 2600 mm. With twin basins and various sink base options, Capricorn can accommodate any tap system. Multiple storage options can be specified including shelves and drawers.

SPECIFICATION

Model	Capricorn
Dimensions (mm) (tolerance ±2 mm)	Length (L): 1400-2600 Height (H): 120-250 or 350-450 w/storage Depth (D): 450-650
Approximate weight	45-65 kg

CONFIGURATION

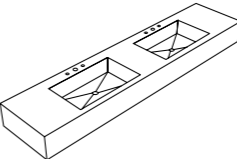
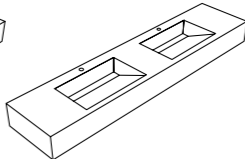
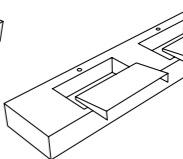
Base type	[Fixed straight base]	[Fixed sloping base]	[Removable base]
			
Waste	[Chrome] [Black] [Brass]	Hidden waste	Hidden waste
Tap mounting position	[Wall-mounted] [Surface-mounted]		

SURFACE SHOWN: FIOR DI BOSCO - POLISHED



CAPRICORN WITH SURFACE-MOUNTED TAP (FIG.100.2)



CAPRICORN 1800 x 550 x 150 mm WITH MATCHING VANITY SHELF (FIG.101.1)

EXPERIMENTING WITH COLOUR

Designing with electrifying colours can be a game-changer in creating a unique bathroom. However, for the perfect balance, it's important to pair these bold hues with warm tones to calm your space. The advancement in porcelain slab design is driving towards impact rather than coherence. Use earthy browns and soft neutrals to counterbalance the boldness of daring colours, to create a harmonious blend that adds depth and dimension to the design. Explore these exciting, blended graphics in our bathroom product collection.



LIQUID PURPLE
POLISHED



JATOBA BROWN
SILK

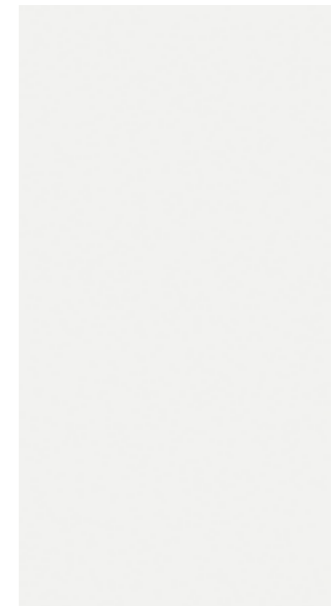

TITANIUM WHITE
NATURAL



CAPRICORN WITH DRAWER AND SHELF (FIG.102.1)



CAPRICORN WITH SINGLE RECESS (FIG.102.2)

CAPRICORN STORAGE

Capricorn provides flexible storage options in the form of drawers and shelves. Single, double or triple configurations can be catered for in any combination of drawer and shelf. Premium push-to-open runners continue the luxury feel, while waste pipes are hidden from view within the unit. Capricorn models can be specified with a single or double cavity for storage buckets, laundry baskets or waste bins.

STORAGE CONFIGURATION

Storage Options [None] [Single Shelf] [Double Shelf]

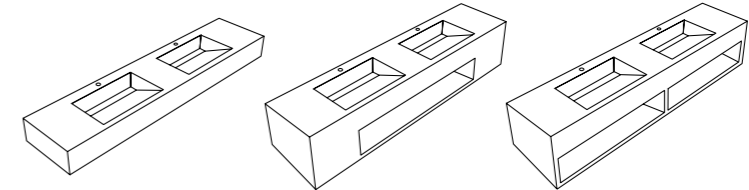

[Double Drawer] [Drawer & Shelf] [Triple Drawer]

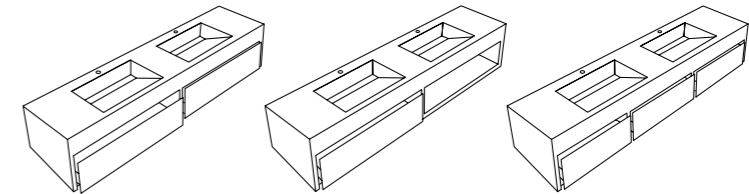

Cavity or Recess Capricorn models can be specified with a recess suitable for storing hand towels and toiletries or a cavity / opening for storage buckets, laundry baskets or waste bins.

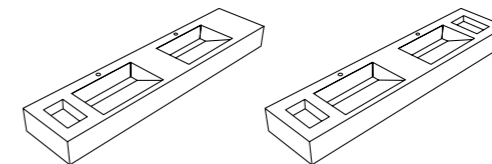



CAPRICORN 1400 x 550 x 400 mm WITH DRAWER AND SHELF (FIG.103.1)



CAPRICORN 2200 x 550 x 400 mm WITH TRIPLE DRAWER AND TWIN RECESS (FIG.103.3)



CAPRICORN 2200 x 550 x 400 mm WITH FIXED SLOPING BASE AND SINGLE SHELF (FIG.103.2)



CAPRICORN 2200 x 550 x 400 mm WITH FIXED SLOPING BASE AND SINGLE SHELF (FIG.103.4)



SCORPIO 2200 x 600 x 300 mm WITH FIXED STRAIGHT BASE (FIG.104.1)

SCORPIO WALL-MOUNTED DOUBLE TROUGH BASIN

Scorpio is a deluxe wall-mounted double trough basin which can be specified with a fixed straight or sloping base. Suitable for two people, Scorpio can be specified with any tap system arrangement.

SPECIFICATION

Model	Scorpio
Dimensions (mm) (tolerance ± 2 mm)	Length (L): 1200-2600 Height (H): 200-400 Depth (D): 450-650
Approximate weight	50 kg

SURFACE SHOWN: FIOR DI BOSCO - POLISHED



SCORPIO WITH SURFACE-MOUNTED TAPS (FIG.104.2)



SCORPIO WITH FIXED SLOPING BASE AND SINGLE SIDE RECESS (FIG.105.1)



SCORPIO WITH FIXED SLOPING BASE AND SINGLE SIDE RECESS (FIG.105.2)

SCORPIO CONFIGURATION

Recesses for storing hand towels and toiletries are available, while cavities suitable for storage buckets, laundry baskets or waste bins can be optioned at both ends of the unit.

CONFIGURATION

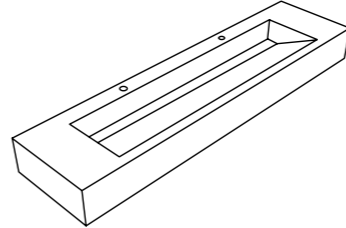
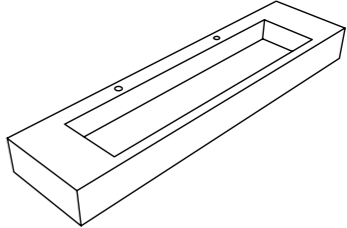
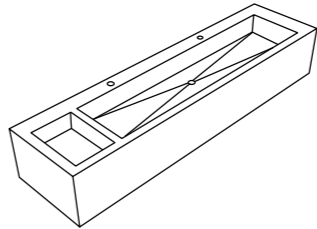
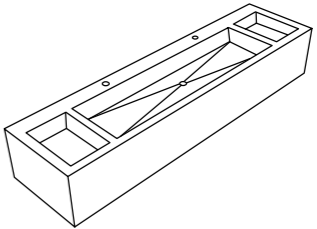
Base type	[Fixed sloping base]	[Fixed straight base]
		
Waste	Hidden Waste	[Chrome][Black][Brass]
Cavity or Recess	Scorpio models can be specified with a recess suitable for storing hand towels and toiletries or a cavity /opening for storage buckets, laundry baskets or waste bins.	
		
Tap mounting position	[Wall-mounted][Surface-mounted]	



VIRGO WITH SINGLE FLUTED DRAWER 2400 x 600 x 230 mm (FIG.106.1)

VIRGO VANITY TOP WITH STORAGE

The Virgo vanity top with integrated storage provides ample space to keep your bathroom essentials organised and within reach. With its sleek and functional design, it is perfect for small bathrooms that need extra storage, or for larger bathrooms that require additional organisation. The push-to-open drawers provide a smooth and effortless opening, while the wall-mounted design keeps your space looking clean and clutter-free.

SPECIFICATION

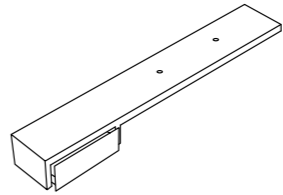
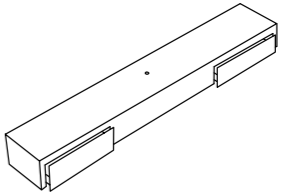
	Model	Single drawer	Double drawer
			
Dimensions (mm) (tolerance ±2 mm)		Length (L): 1401-2600 Depth (D): 400-650	
Approximate weight		40-50 kg	
Top height (mm)		50-300 mm	
Drawer height (mm)		160-300 mm	
Decoration		[Fluted] [None]	



VIRGO VANITY TOP WITH SINGLE DRAWER 2400 x 600 x 230 mm (FIG.107.1)

EXPERIMENTING WITH COLOUR

Go bold with an anapologetically daring feature wall, and maintain balance by pairing with structured aggregate surfaces. Both dominants and monochromatic in colour. The sleekness of Virgo and imposing scale of 3D Mirror adds a visually convincing dimension. This approach ensures the space has interaction and poise. Embrace visual contrast in our bathroom product collection.



AGATA BLU
POLISHED



TAUPE
NATURAL

SURFACE SHOWN: FIOR DI BOSCO - POLISHED & TROPICAL BLACK - POLISHED



VIRGO WITH DOUBLE DRAWER 2400 x 600 x 230 mm. SHOWN HERE WITH GEMINI SURFACE-MOUNTED BASIN (FIG.108.1)



VANITY TOP 1000 x 500 x 100 mm WITH FLUTED DECORATION (FIG.109.1)

VANITY TOP

Our wall-mounted vanity tops offer the widest range of colours for interior designers to choose from, allowing them to create a sophisticated look that complements any bathroom decor. From elegant marble finishes to authentic stone textures, these tops can be customised to meet your precise size and installation needs, with lengths up to 2600 mm and heights from 50 to 120 mm. The pre-drilled cut-outs for taps and waste make them compatible with all vessel and countertop basins and tap systems.



VANITY TOP 2600 x 500 x 100 mm WITH TWIN VESSEL BASINS (FIG.109.2)

SURFACE SHOWN: FIOR DI BOSCO - POLISHED

SPECIFICATION

Model	Vanity Top
Dimensions (mm) (tolerance ±2 mm)	Length (L): 600-2600 Height (H): 50-120 Depth (D): 400-650
Approximate weight	15 kg per linear metre

CONFIGURATION

Decoration	[Fluted] [None]
Tap mounting position	[Wall-mounted] [Surface-mounted]
No. of pre-drilled tap holes	[] Please consult tap manufacturer's specification.

SURFACE-MOUNTED VANITY TOP WITH CUT-OUT

Vanity top with cut-out is a surface-mounted top to be installed above an existing vanity or storage unit (not supplied). Surface-mounted tops can be specified with heights of 12 mm, 20 mm, or a custom height between 40-100 mm. Tops are supplied with laser cut openings for inset or under-mount basins (not supplied). Ellipse or rectangular cut-outs can be accommodated in single or multiple arrangements. Please provide the basin manufacturer's fitting specification. See over for wall-mounting options.



SURFACE SHOWN: FIOR DI BOSCO - POLISHED

SURFACE-MOUNTED WITH CIRCULAR CUT-OUT 1000 x 600 x 50 mm (FIG.110.1)

SPECIFICATION

Model	Surface-mounted vanity top with cut-out		
Height (H)	40-100 mm	12 mm	20 mm
Length (L)	600-2600 mm	∞ (joint every 3200 mm)	∞ (joint every 3200 mm)
Depth (D)	500-700 mm	500-700 mm	500-700 mm
Approximate weight	26 kg per m ²	40 kg per m ²	56 kg per m ²
Edge profiles	Vanity tops are supplied as standard with their front and inner edges profiled. Sides and rear edges can also be specified.		
Profile	Mitred	[Double Pencil][Bevelled][Double Bevelled] [Bullnose][Half Bullnose][Shark Nose]	
Surface-mounted installation			
Basin cut-outs	[1][2][3] Please consult basin specification.		
Integrated basin	[1][2][3]		
Shape of cut-outs	[Circular][Ellipse][Rectangular] Please consult basin specification.		
Basin fitting type	[Top-mounted][Under-mounted][Integrated]		
Pre-drilled tap holes	[] Please consult tap specification.		

SURFACE SHOWN: FIOR DI BOSCO - POLISHED



SURFACE-MOUNTED WITH CIRCULAR CUT-OUT 1000 x 600 x 50 mm (FIG.111.1)



SURFACE-MOUNTED WITH TWO ELLIPSE CUT-OUTS 2040 x 600 x 12 mm (FIG.111.2)

SURFACE SHOWN: KUROKA 4D - POLISHED



SURFACE-MOUNTED VANITY TOP WITH THREE ELLIPSE CUT-OUTS 3000 x 600 x 20 mm WALL CABINET NOT SUPPLIED (FIG.112.1)

WALL-MOUNTED VANITY TOP WITH CUT-OUT

With multiple mounting options vanity top with cut-outs can also be wall-mounted with a height from 100 to 400 mm. Tops are supplied with laser cut openings for inset or under-mount basins (not supplied). Ellipse or rectangular cut-outs can be accommodated in single or multi-basin arrangements.

SURFACE SHOWN: FIOR DI BOSCO - POLISHED



WALL-MOUNTED WITH TWO RECTANGULAR CUT-OUTS 2200 x 550 x 350 mm (FIG.113.1)

SPECIFICATION

Model	Wall-mounted vanity top with cut-out	
Height (H)	100-400 mm	
Length (L)	600-2600 mm	
Depth (D)	500-700 mm	
Approximate weight	26 kg per m ²	
Edge profiles	Vanity tops are supplied as standard with their front and inner edges profiled. Sides and rear edges can also be specified.	
Profile	Mitred	
Wall-mounted installation		
Basin cut-outs	[1] [2] [3] Please consult basin specification.	
Integrated basin	[1] [2] [3]	
Shape of cut-outs	[Circular] [Ellipse] [Rectangular] Please consult basin specification.	
Basin fitting type	[Top-mounted] [Under-mounted] [Integrated]	
Pre-drilled tap holes	[] Please consult tap specification.	

SURFACE SHOWN: FIOR DI BOSCO - POLISHED



WALL-MOUNTED WITH THREE ELLIPSE CUT-OUTS 2600 x 500 x 200 mm (FIG.114.1)

SURFACE SHOWN: FIOR DI BOSCO - POLISHED



VANITY SHELF 2200 x 550 x 60 mm (FIG.115.1)

VANITY SHELF

Fully configurable, this vanity shelf can be specified in a range of colours and matched with wall and floor tiling to create the appearance of one continuous surface. Available in Marble, Stone and Concrete styles, each shelf is wall-mounted and sized to your specific dimensions. Lengths up to 2600 mm and heights of 200 mm are possible. Vanity shelf can be paired with a wall-mounted basin and our Globo storage unit.

SPECIFICATION

Model	Vanity Shelf
Dimensions (mm) (tolerance ± 2 mm)	Length (L): 600-2600 Height (H): 50-200 Depth (D): 400-650
Approximate weight	25 kg per linear metre



GLOBO 1400 x 500 x 180 mm WITH DOUBLE DRAWER (FIG.116.1)



GLOBO 1400 x 500 x 180 mm WITH FLUTED DRAWER AND SHELF (FIG.116.2)

SURFACE SHOWN: FIOR DI BOSCO - POLISHED

GLOBO

Whether you use it on its own or pair with one of our wall-mounted basins, Globo provides additional storage options for high-end bathroom projects. Globo offers plenty of storage space and can be configured with drawers or shelving. Globo comes ready for wall-mounting, with premium push-to-open drawers and can be specified in length from 650 to 2600 mm making it suitable for bathrooms of all sizes.

SPECIFICATION

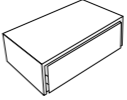
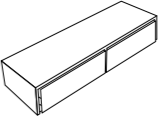
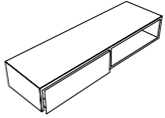
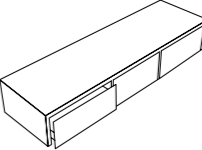
Height (mm)	180-300	
Depth (mm)	400-650	
Model	Single Drawer	Double Drawer
Length (mm)	650-780	781-1560
		
Model	Drawer & Shelf	Triple Drawer
Length (mm)	781-1560	1401-2600
		
Decoration	[Fluted] [None]	

SURFACE SHOWN: FIOR DI BOSCO - POLISHED



GLOBO 2180 x 500 x 300 mm WITH TRIPLE DRAWER (FIG.117.1)

VENUS

Ideal for smaller sized washrooms and cloakrooms, Venus is a free-standing single washbasin and is available with configurable storage including shelving, drawers or cupboard space.

SPECIFICATION

Model [No storage] [Double stacked shelf]

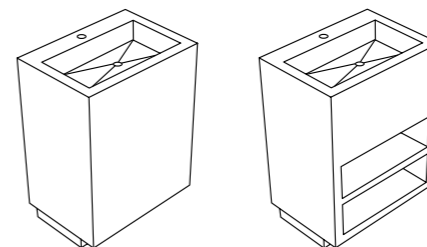

[Single drawer] [Double stacked drawer] [Cupboard]

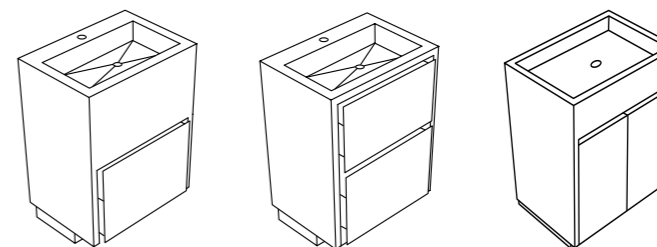

Dimensions (mm) Length (L): 500-780
Height (H): 850-950
Depth (D): 450-650
(tolerance ± 2 mm)

Internal Finish [Beige Linen] [Grey Tweed] [Denver Oak] [French Elm] [Grey Venice]
[Light Westminster Oak] [Missouri Walnut] [Quartz] [Smoked Oak]

Door/Drawer Edge Finish [Internal Veneer] [Metal Banding] [Tile Cladding]

Base type [Fixed straight base] [Fixed sloping base] [Removable base]

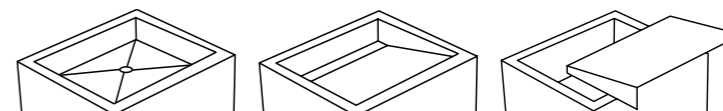

SURFACE SHOWN: FIOR DI BOSCO - POLISHED



VENUS 650 x 550 x 900 mm WITH DOUBLE STACKED SHELF FIXED STRAIGHT BASE (FIG. 118.1)



VENUS 650 x 550 x 900 mm WITH FIXED STRAIGHT BASE (FIG.119.1)

EXPERIMENTING WITH COLOUR

The elegant beauty of precious stone is known for its luxurious feel and timeless appeal. Pair with the raw aesthetic of industrial concrete to create contrast, and an unexpected fusion. It's an enticing scene of urban chic, that elevates the dynamic identity of Venus to a whole new level. Embrace the power of opposing surfaces to unlock exciting design possibilities in our Bathroom Product Collection.



REVE ROSE
POLISHED



BURNISHED
NATURAL

SURFACE SHOWN: FIOR DI BOSCO - POLISHED



LEFT: VENUS 650 x 550 x 900 mm DOUBLE STACKED DRAWER FIXED STRAIGHT BASE
RIGHT: VENUS WITH SINGLE DRAWER AND FIXED STRAIGHT BASE (FIG.120.1)



VENUS 700 x 550 x 900 mm CUPBOARD WITH TWO INTERNAL SHELVES (FIG.120.2)

SURFACE: FIOR DI BOSCO - POLISHED & TROPICAL BLACK- POLISHED



SATURN 2200 x 550 x 850 mm FREE-STANDING DOUBLE BASIN (FIG.121.1)

SATURN

Saturn is a luxury free-standing washbasin with a twin sink arrangement. Substantial in size and prestige, Saturn hides all pipe work and provides an access panel to the rear for servicing. For a true statement piece, pair with a bold tap system of your choice and design with contrasting colours.

SPECIFICATION

Dimensions (mm) (tolerance ±2 mm)	Length (L): 1800-2200 Height (H): 850-900 Depth (D): 500-650
---------------------------------------------	--------------------------------------------------------------------

Approximate weight	120-150 kg
---------------------------	------------

CONFIGURATION

Waste	[Chrome] [Black] [Brass]
--------------	--------------------------------

Tap mounting position	[Wall-mounted] [Surface-mounted]
------------------------------	--------------------------------------

Position of access panels	[Rear] [Side] (There is one access panel per sink unit)
----------------------------------	-------------------------------------------------------------

MERCURY

Mercury is a free-standing double trough washbasin that can be configured with one, two or three wash stations. With various colours and styles to choose from and custom-sized to fit your space, Mercury offers unrivalled configuration options. Suitable for both residential and commercial installation, Mercury can be specified with a side or rear facing access panel, multiple tap systems and counter mounted soap dispensers.

SURFACE SHOWN: FIOR DI BOSCO - POLISHED



MERCURY 1660 x 650 x 850 mm WITH SURFACE-MOUNTED TAPS (FIG.122.1)

SPECIFICATION

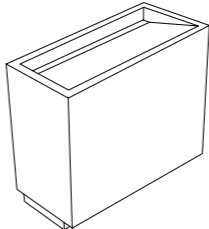
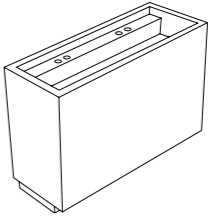
	Fixed sloping base	Fixed straight base
Base type	Fixed sloping base	Fixed straight base
		
Dimensions (mm) (tolerance ±2 mm)	Length (L): 1200-2600 Height (H): 850-900 Depth (D): 450-650	
Approximate weight	120-150 kg	
Waste	[Chrome][Black][Brass]	
Tap mounting position	[Surface-mounted][Wall-mounted] Surface-mounted taps require a fixed straight base as shown opposite. Wall-mounted taps require a fixed sloping base as shown on the next page.	
No. of pre-drilled tap holes	[] Please consult tap manufacturer's specification.	
Position of access panel	[Rear][Sides] Two access panels are required for Max if access is from the sides.	

EXPERIMENTING WITH COLOUR

Discover the enchanting allure of exquisite opal stone, renowned for its opulent touch and enduring charm. Combine with the rugged aesthetic of industrial concrete to forge an intriguing juxtaposition. Witness a captivating display of urban chic that propels Mercury's dynamic identity to new heights. Embrace the potential of contrasting surfaces, unlocking a realm of thrilling design possibilities within our bathroom product collection.



MERCURY 1895 x 650 x 850 mm (FIG.123.1)



REVE BLEU
POLISHED



BURNISHED
NATURAL

SURFACE SHOWN: FIOR DI BOSCO - POLISHED



MERCURY 1895 x 650 x 850 mm WITH WALL-MOUNTED TAPS (FIG.124.1)



MERCURY WITH FIXED SLOPING BASE (FIG.124.2)

BASIN BASE & TAP SYSTEMS

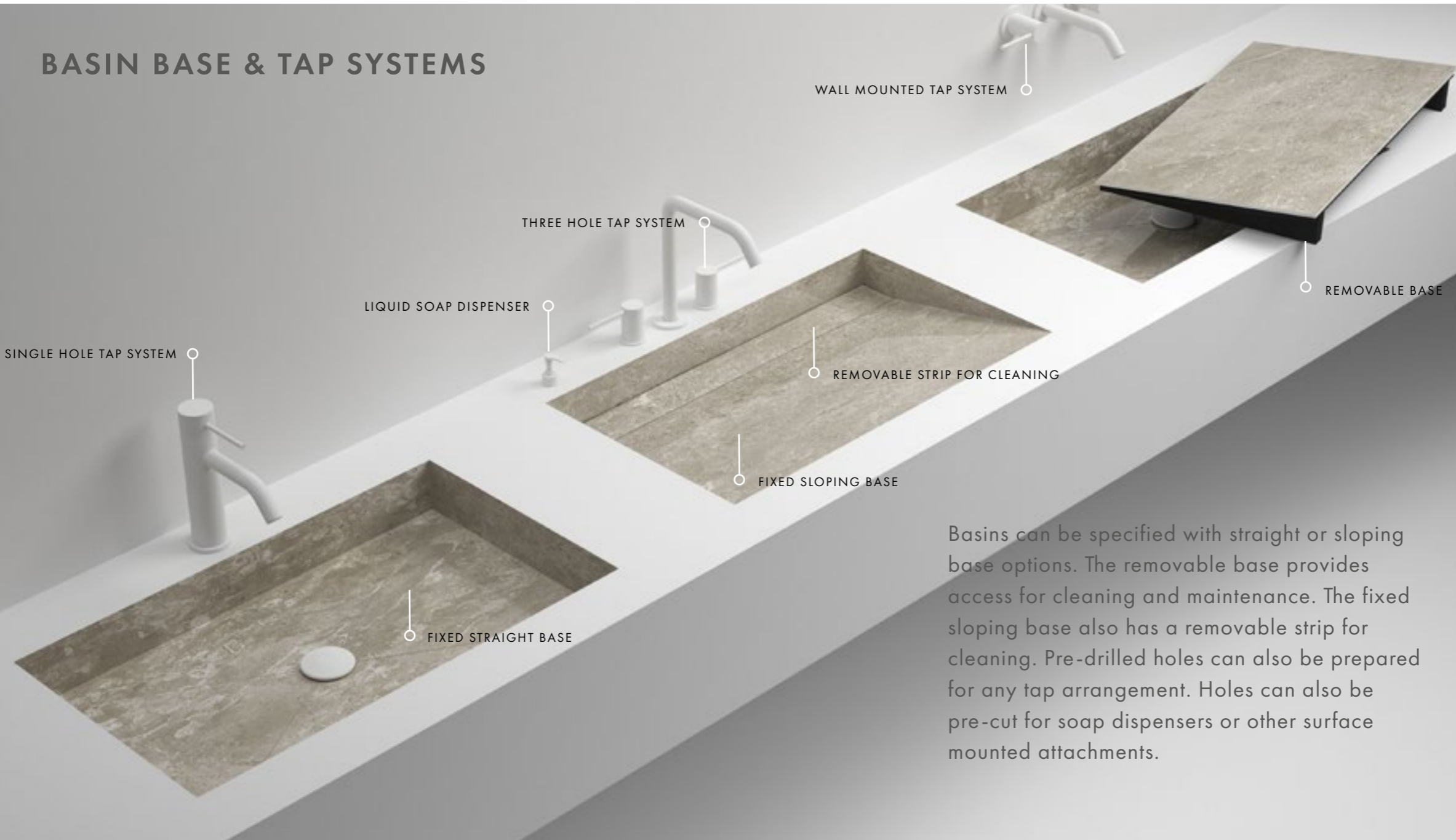

Basins can be specified with straight or sloping base options. The removable base provides access for cleaning and maintenance. The fixed sloping base also has a removable strip for cleaning. Pre-drilled holes can also be prepared for any tap arrangement. Holes can also be pre-cut for soap dispensers or other surface mounted attachments.

POCKETS

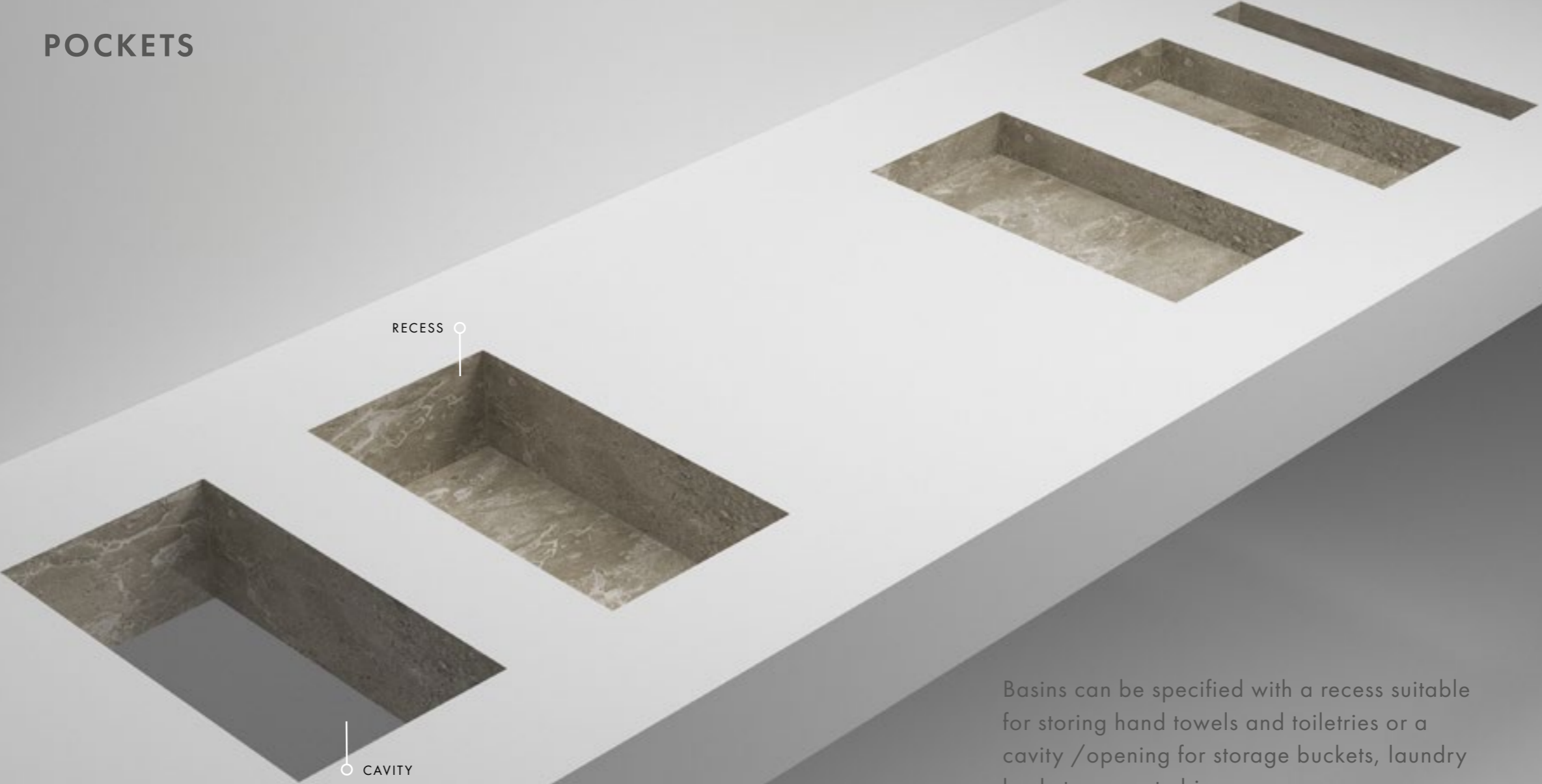

Basins can be specified with a recess suitable for storing hand towels and toiletries or a cavity /opening for storage buckets, laundry baskets or waste bins.

STORAGE OPTIONS



Transform your bathroom into a clutter-free oasis by adding the optional drawers and shelves. With ample space for all your essentials each item becomes a spacious and versatile storage unit. Single, double or triple drawer arrangements can be catered for in any combination of drawer and shelf.

VENEER COLOUR OPTIONS

Premium push-to-open or soft-close runners continue the luxury feel, while a selection of internal veneers and door edge finish choices provide further personalisation.



SMOKED OAK

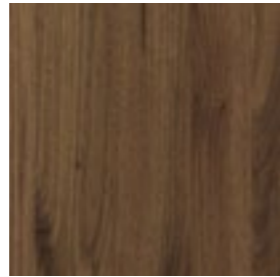

MISSOURI WALNUT



FRENCH ELM



LIGHT WESTMINSTER OAK



DENVER OAK



GREY VENICE



QUARTZ



BEIGE LINEN



GREY TWEED



MISSOURI WALNUT VENEER (FIG. 128.1)

SURFACE SHOWN: FIOR DI BOSCO - NATURAL



SHOWER TRAY RECT1200 SIZE 1200 x 800 mm (FIG.129.1)

SHOWER TRAY

Available in the full range of colours, this shower tray can be specified in the same surface material as the flooring. Three popular sizes are shown but custom specifications are possible to fit with project requirements. This item is supplied with hidden drainage system.

SPECIFICATION

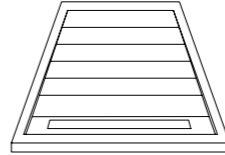
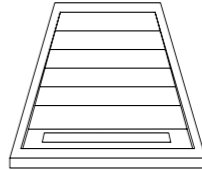
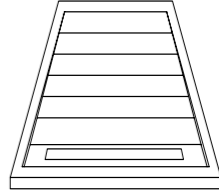
Item	Shower Tray		
Description	Low profile tray with drainage system		
Model	SQ900	RECT1200	RECT1500
			
Dimensions (mm) (tolerance ± 2 mm)	Length (L): 900 Depth (D): 900 Height (H): 70	Length (L): 1200 Depth (D): 800 Height (H): 70	Length (L): 1500 Depth (D): 850 Height (H): 70
Approximate weight	20 kg	25 kg	30 kg



DEEP FRAME BATHROOM MIRROR 2000 x 840 x 200 mm (FIG.130.1)

3D MIRROR

Every successful bathroom project needs a mirror, so complete your design with this deep framed bathroom mirror, providing additional shelf space for toiletries and accessories. Sized to match your vanity top and fit your space in lengths up to 2600 mm, this mirror can be mounted horizontally on a wall (using the supplied hanger), or leaned vertically against a wall. Specify to complement existing elements of your bathroom design.

SPECIFICATION

Dimensions (mm) (tolerance ± 2 mm)	Length (L): 600 - 2600 Height (H): 650 - 1000 Depth (D): 100 - 200
Approximate weight	50 kg
Fixing type	Wall Hanging. This unit is supplied with a Z Bar mirror hanger



VANITY GOALS:
INSPIRING BATHROOM VANITY
DESIGNS FOR EVERY STYLE



TABLE COUTURE:
THE ART OF SELECTING
THE PERFECT PIECE FOR YOUR SPACE.

TAVOLO ORIGAMI (FIG.132.1)

EXPANDING IDEAS: FURNITURE COLLECTION

Introducing an exquisite collection of furniture. Each piece has been crafted with Italian porcelain, the perfect surface solution for interior designers seeking to create striking centerpieces and one-off originals.

All items are manufactured in the UK which means shorter lead times and no logistical headaches. Customer support and delivery services are provided locally.

The collection features a variety of furniture items including dining tables, consoles, coffee and side tables, all made-to-order and customisable in a wide array of original colours and finishes. Each piece boasts a durable and high-performance surface that requires minimal maintenance and is suitable for both residential and commercial use.



TAVOLINO ROMANO GRANDE (left) MEDIO (centre) PICCOLO (right) (FIG.134.1)



TAVOLINO ROMANO MEDIO (FIG.135.1)

TAVOLINO ROMANO

Tavolino Romano is a combination of elements. A fluted circular wooden base melts away as the stunning porcelain top appears to defy gravity. Base is made from moulded tulip wood which supports a 20 mm thickness porcelain top. Alternative surfaces available. Combine sizes and colours for contrast or allow just one Tavolino Romano to tell its own beautiful story.

SPECIFICATION

Grande (mm) (tolerance ±2 mm)	Diameter:	1250
	Height:	400
	Base Diameter:	480

Medio (mm)	Diameter:	700
	Height:	600
	Base Diameter:	360

Piccolo (mm)	Diameter:	600
	Height:	400
	Base Diameter:	300

Table top	20 mm thickness with double bevel*
------------------	------------------------------------

Base design	Circular base in black. Other finishes available
--------------------	--------------------------------------------------

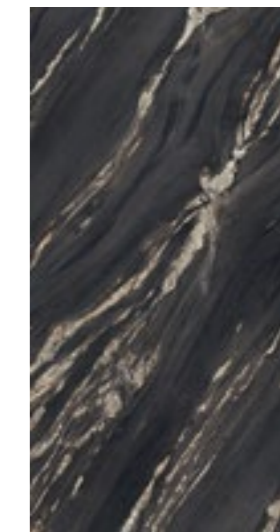

KUROKA 4D
POLISHED
20 mm THICKNESS

*Other colours available in 12 and 20 mm thicknesses



TAVOLINO ROMANO GRANDE (FIG. 136.1)

TAVOLO LUNA ROMANO

Tavolo Luna Romano, a luxurious and elegant addition to any dining room. The table's clean lines are beautifully balanced by contrasting tones, creating a striking and sophisticated look. The elegant round top dining table is supported by a single pillar base that can be customised to your taste with a selection of colour combinations and finishes. The top has a diameter of 1450 mm and the base is 450 mm making this table perfect for any high-end dining room.



TAVOLO LUNA ROMANO (FIG.137.1)

SPECIFICATION

Dimensions (mm) (tolerance ± 2 mm)	Diameter: 1450 Height (H): 760
Table top	20 mm thickness with double bevel*
Base design	Circular base in black. Other finishes available
Base diameter	450 mm

*Other colours available in 12 and 20 mm thicknesses

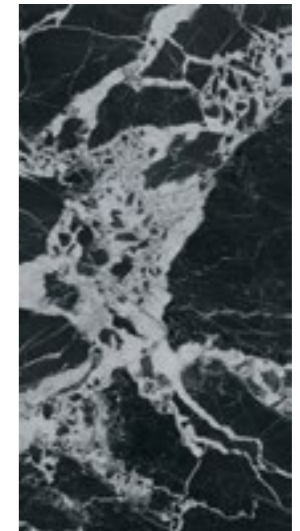

GRAND ANTIQUE 4D
POLISHED
20 mm THICKNESS



TAVOLO MEZZALUNA ROMANO (FIG.138.1)

TAVOLO MEZZALUNA ROMANO

Elevate the sophistication of your dining space with the Tavolo Mezzaluna Romano. This extraordinary centrepiece boasts a streamlined chic, featuring a generously spacious tabletop and a pair of fluted semicircular pedestal legs. Able to reflect your personal style with a plethora of finishes and colour options to choose from, the Tavolo Mezzaluna Romano stands as the ultimate focal point.

SPECIFICATION

Dimensions (mm) (tolerance ± 2 mm)	Length (L): 2800
	Depth (D): 1200
	Height (H): 760
Table top	20 mm thickness with double bevel
Base design	500 mm Semicircular base in black. Other finishes available

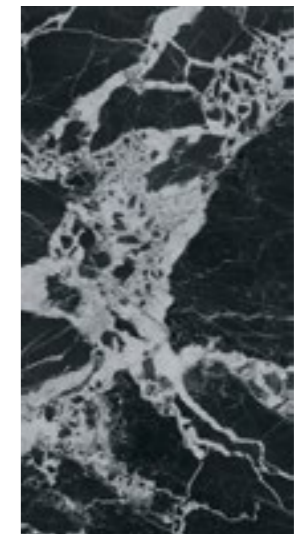

GRAND ANTIQUE 4D
POLISHED
20 mm THICKNESS

TAVOLINO ORIGAMI

The Tavolino Origami is a refined and stylish piece of furniture, designed to add a touch of playfulness and modernity to any living space. Available in two complementary sizes, this table is dressed in a striking contrasting colourway, making it a striking focal point in any room. The Tavolino Origami features a polished white marble effect top and Sahara Noir base for a luxurious and upscale feel. For maximum impact, place two in an open living space to create a cohesive and elegant design.



TAVOLINO ORIGAMI GRANDE (left) AND MEDIO (right) (FIG.139.1)

SPECIFICATION

Grande (mm) (tolerance ±2 mm)	Length (L): 1200 Depth (D): 1200 Height (H): 280
Medio (mm)	Length (L): 900 Depth (D): 900 Height (H): 380
Table top	12 mm thickness with double bevel
Base design	Rectangular base

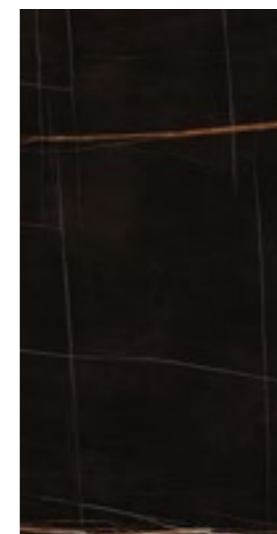

SAHARA NOIR
POLISHED
6 mm THICKNESS

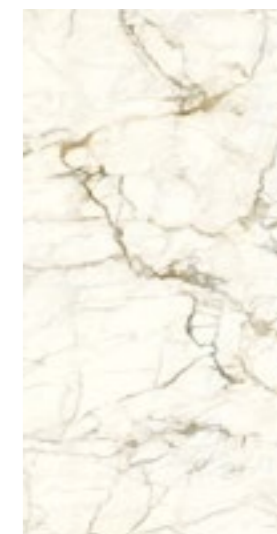

CALACATTA MACCHIA VECCHIA
POLISHED
12 mm THICKNESS



TAVOLINO ORIGAMI (FIG.140.1)



TAVOLINO ORIGAMI (FIG.140.2)

TAVOLO ORIGAMI

Tavolo Origami, a masterpiece of luxury furniture, designed to furnish the most contemporary of living spaces. Shown here in its two-tone version, but also available in a single stone, this dining table is crafted from the most luxurious materials and expertly made to ensure it is a true work of art. It can be tailored to your preferences with various colours and finishes to choose from. With its sleek and sophisticated design, the Tavolo Origami comfortably seats eight people and makes a perfect centerpiece for any high-end dining room.



TAVOLO ORIGAMI (FIG.141.1)

SPECIFICATION

Dimensions (mm) (tolerance ± 2 mm)	Length (L): 2800
	Depth (D): 1200
	Height (H): 760
Table top	60 mm thickness with mitred edge
Base design	Rectangular base

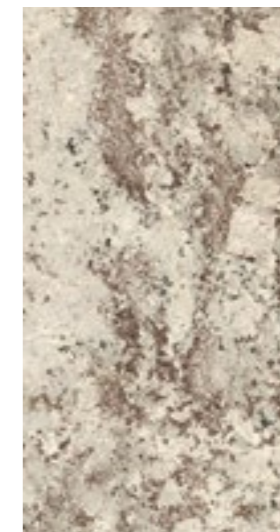

ALASKA WHITE
SILK
6 mm THICKNESS



JATOBA BROWN
SILK
6 mm THICKNESS



TAVOLO ORIGAMI (FIG.142.1)



CONSOLLE ORIGAMI (FIG. 143.1)

CONSOLLE ORIGAMI

Consolle Origami is an elegant and refined console table, designed with modern aesthetic and sculptural appeal. It provides a functional space to display your object d'art and is a masterpiece of craftsmanship. Consolle Origami is a statement piece that can add character to any living space. To make an even stronger impact, opt for the two-tone colour combination which creates a truly unique and striking piece. It is an ideal addition for those looking to elevate their home decor with a touch of luxury and exclusivity.

SPECIFICATION

Dimensions (mm) (tolerance ± 2 mm)	Length (L): 2000
	Depth (D): 500
	Height (H): 900
Console top	40 mm thickness mitred edge
Base design	Rectangular base



DEEP NORWAY
POLISHED
6 mm THICKNESS

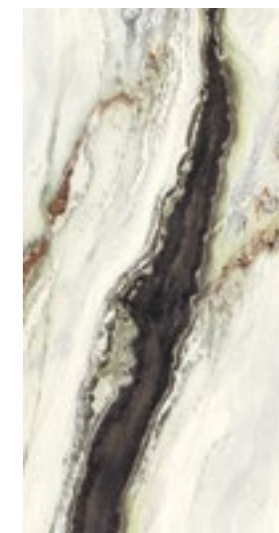

PANDA WHITE
POLISHED
6 mm THICKNESS



CONSOLLE ORIGAMI (FIG.144.1)



CONSOLLE ORIGAMI (FIG.144.2)

TAVOLO MEZZALUNA VENEZIANA

Introduce a touch of contemporary elegance to your dining room with the Tavolo Mezzaluna Veneziana. This statement piece showcases a sleek modern design with a grand, expansive top and a twin semicircular base. The table can be customised to suit your taste with a variety of finishes and colour variations available. The table design and its unique detail make it the perfect centerpiece for any luxurious dining room.



TAVOLO MEZZALUNA VENEZIANA (FIG. 145.1)

SPECIFICATION

Dimensions (mm) (tolerance ± 2 mm)	Length (L): 2800
	Depth (D): 1200
	Height (H): 760
Table top	6 mm thickness with double bevel
Base design	Semicircular base



BLUE TEMPEST
POLISHED
6 mm THICKNESS



JATOBA BROWN
SILK
6 mm THICKNESS



TAVOLO MEZZALUNA VENEZIANA (FIG. 146.1)



TAVOLO MEZZALUNA VENEZIANA (FIG. 146.2)

TAVOLO LUNA VENEZIANA

Tavolo Luna Veneziana, a luxurious and elegant addition to any dining room. The table's clean lines are beautifully balanced by contrasting tones, creating a striking and sophisticated look. The elegant round top dining table is supported by a single pillar base that can be customised to your taste with a selection of colour combinations and finishes. The top has a diameter of 1450 mm and the base is 450 mm making this table perfect for any high-end dining room.



TAVOLO LUNA VENEZIANA (FIG.147.1)

SPECIFICATION

Dimensions (mm) (tolerance ± 2 mm)	Diameter:	1450
	Height (H):	760
Table top	6 mm thickness with double bevel	
Base design	Circular	
Base diameter	450 mm	



ONICE NERO
POLISHED
6 mm THICKNESS



BELLINI
NATURAL
10 mm THICKNESS



TAVOLO LUNA VENEZIANA (FIG.148.1)



TAVOLO LUNA VENEZIANA (FIG.148.2)

TAVOLO TELESTO VENEZIANA

Tavolo Telesto Veneziana is a masterful blend of luxury and elegance, designed to elevate any dining room. Able to seat up to eight people, this grand table boasts a 50 mm thickness top that is harmoniously paired with its twin pedestal base. The top is adorned with a sleek metallic banding that adds a touch of refinement to its overall look. Shown here in an Decorative Bronze finish. Banding can be tailored to your personal style with a variety of alternative finishes available.



TAVOLO TELESTO VENEZIANA (FIG.149.1)

SPECIFICATION

Dimensions (mm) (tolerance ± 2 mm)	Length (L): 2900 Depth (D): 1300 Height (H): 760
Table top	50 mm with metal banding
Base design	Oval base
Profile banding	Metal banding - Decorative Bronze

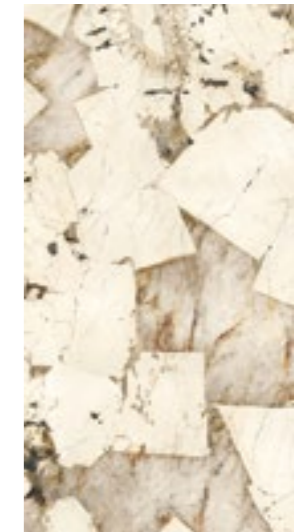

PATAGONIA
SILK
6 mm THICKNESS



TAVOLO TELESTO VENEZIANA (FIG.150.1)

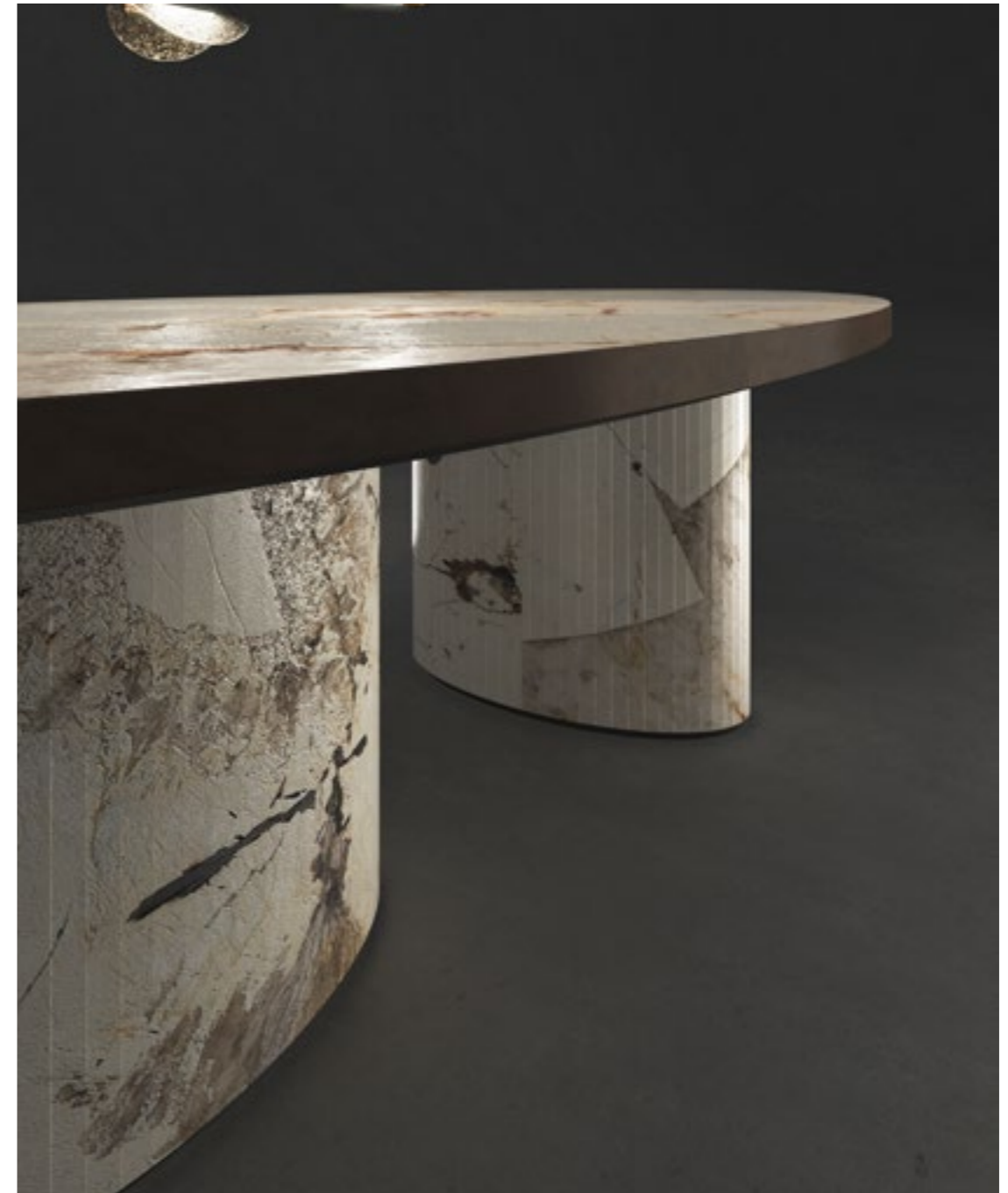

TAVOLO TELESTO VENEZIANA (FIG.150.2)

CONSOLLE VENEZIANA

Consolle Veneziana is a breathtaking piece of furniture, perfect for adding a touch of refined elegance to the entryways or hallways of modern homes. This striking sculptural console table features a twin semicircular base adorned with intricate decoration. This unique design element adds a touch of timeless beauty, making it a true conversation piece. This console table is the perfect blend of form and function, and an ideal addition for those looking to elevate their home decor with a touch of luxury and exclusivity.

SPECIFICATION

Dimensions (mm) (tolerance ± 2 mm)	Length (L): 1700
	Depth (D): 450
	Height (H): 900
Console top	20 mm thickness with double bevel
Base design	Semicircular base

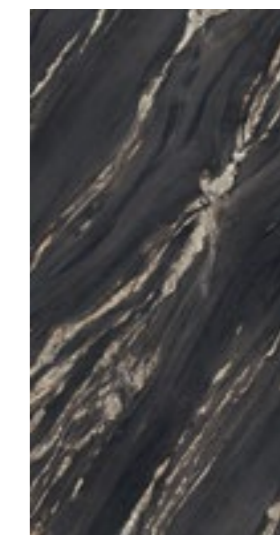

KUROKA 4D
POLISHED
20 mm THICKNESS



CONSOLLE VENEZIANA (FIG. 151.1)



CONSOLLE VENEZIANA (FIG.152.1)

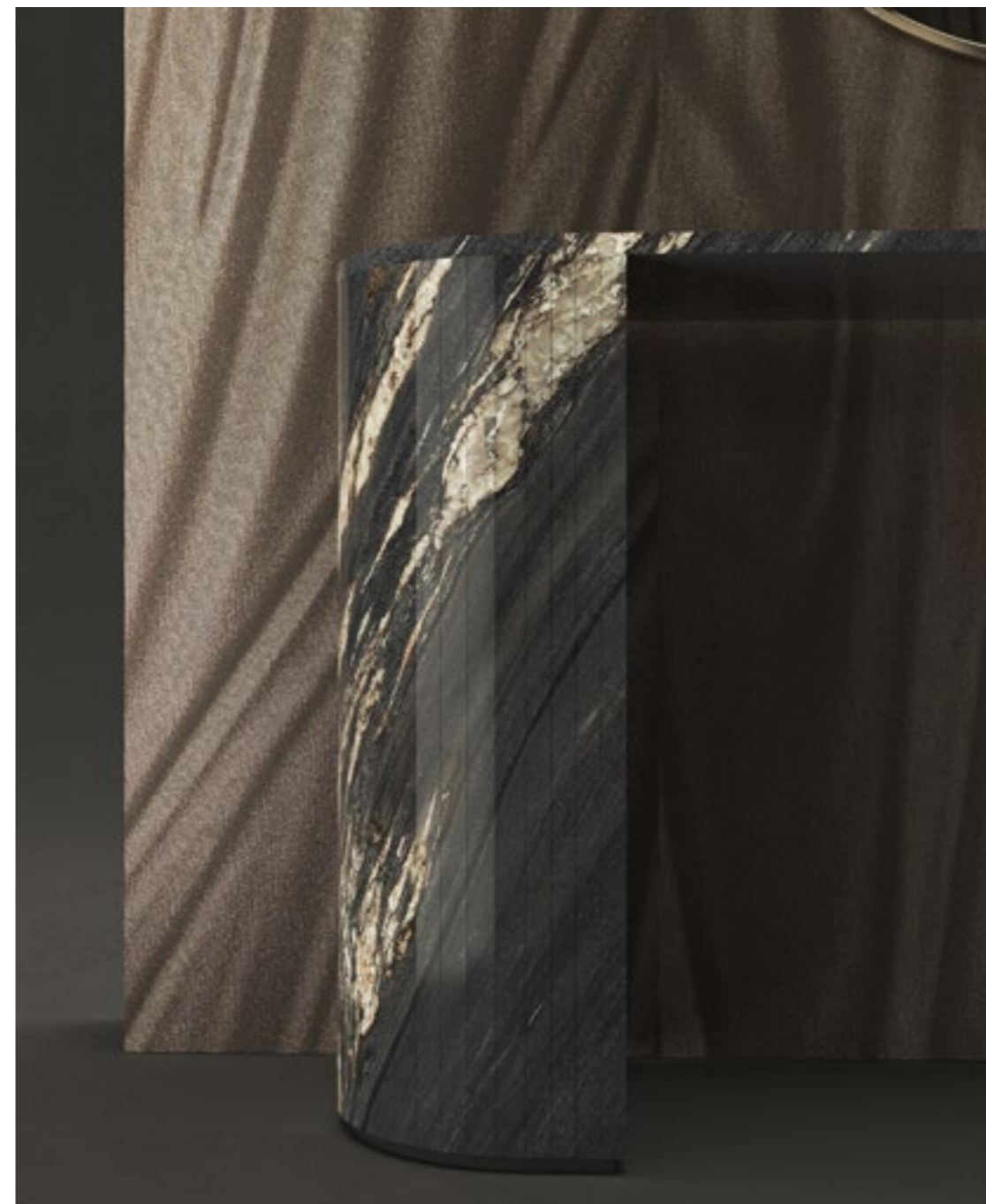

CONSOLLE VENEZIANA (FIG.152.2)

CONSOLLE GESSATO

Consolle Gessato is a work of art, a sophisticated and refined console that combines modern design with timeless elegance. The console boasts an angled rectangular base adorned with a vertical decor. Shown here in two contrasting colours, the 50 mm thickness top features a bold agate stone design, that contrasts beautifully with the white marble effect base. Aesthetically versatile, and bold enough to make a statement in any hallway, Consolle Gessato can be specified in various colour combinations to suit your scheme. It is a perfect blend of form and function, making it a must-have for the discerning home designer seeking to add a touch of luxury and sophistication to their living space.

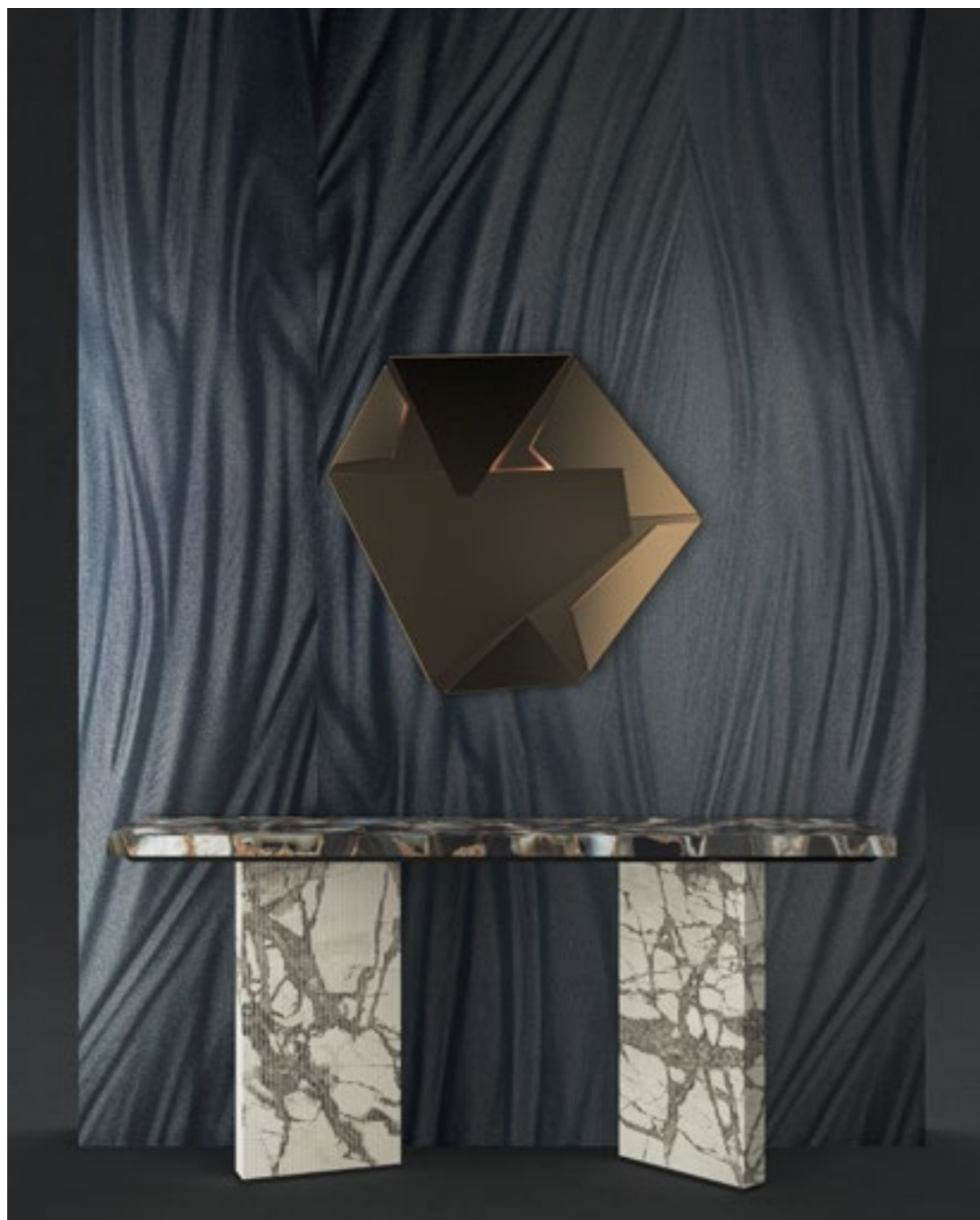

CONSOLLE GESSATO (FIG.153.1)

SPECIFICATION

Dimensions (mm) (tolerance ± 2 mm)	Length (L): 1950
	Depth (D): 450
	Height (H): 900
Console top	50 mm thickness with mitred edge
Base design	Rectangular base
Flute divide	10 mm

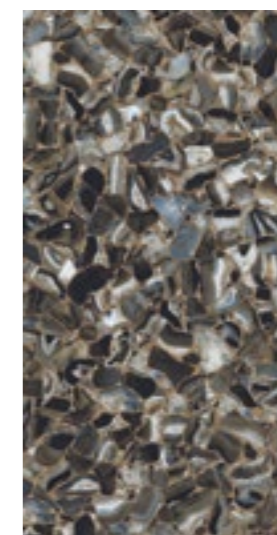

AGATA BLACK
POLISHED
6 mm THICKNESS



IMPERIAL GREY
POLISHED
6 mm THICKNESS



CONSOLLE GESSATO (FIG.154.1)

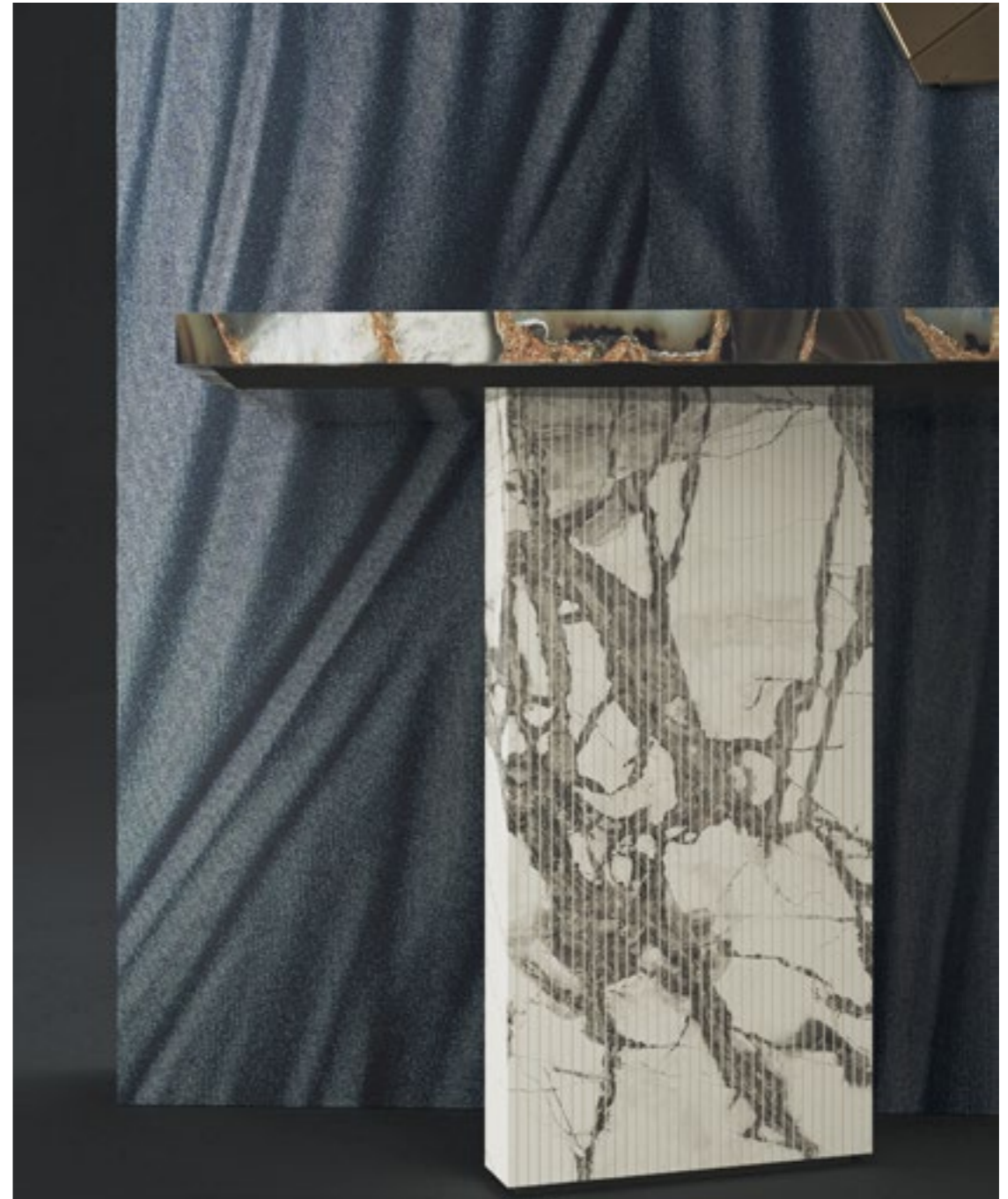

CONSOLLE GESSATO (FIG.154.2)

TAVOLO GESSATO

Tavolo Gessato has been designed to elevate the grandest of living spaces with its dynamic finish and striking design. The structure of this table is a masterpiece of geometric lines, culminating in a magnificent 20 mm thickness Nero Marquina top. The edges are intricately bevelled, and each piece holds its individuality due to the subtle variations within the porcelain stone. The twin rectangular base features a vertical decorative detail that adds an extra touch of elegance. A statement piece that will leave a lasting impression.



TAVOLO GESSATO (FIG.155.1)

SPECIFICATION

Dimensions (mm) (tolerance ±2 mm)	Length (L): 2500 Depth (D): 1100 Height (H): 760
Table top	20 mm thickness with double bevel
Base design	Rectangular base
Flute divide	20 mm



NERO MARQUINIA
POLISHED
20 mm THICKNESS



LABRADORITE
POLISHED
6 mm THICKNESS



TAVOLO GESSATO (FIG.156.1)



TAVOLO GESSATO (FIG.156.2)



TAVOLINO TORNIO GRANDE (FIG.157.1)

TAVOLINO TORNIO

The alliance between product designer and furniture manufacturer can result in truly exceptional pieces that embody the designer's vision while also showcasing the craftsmanship and beauty of the porcelain surface. Tavolino Tornio is a luxurious round coffee and side table set, featuring a single pedestal and sleek rectangular base. Its deceptively simple design is elevated by the contrasting colourways and framed by a metallic band around the top surface. This elegantly minimal piece is available in a variety of alternative colour pairs and metal banding styles, custom crafted to meet your specific tastes and preferences.

SPECIFICATION

Grande (mm) (tolerance ± 2 mm)	Diameter: 1450 Height (H): 400
Medio (mm)	Diameter: 700 Height (H): 600
Table top	40 mm thickness with metal banding
Profile banding	Metal banding - Decorative Bronze

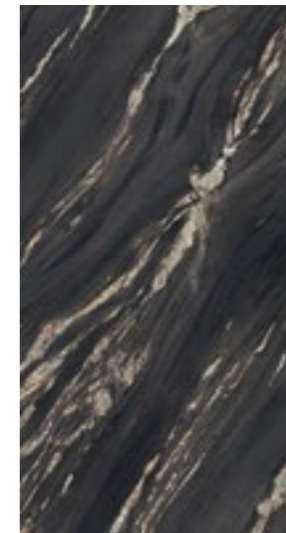

TROPICAL BLACK
POLISHED
6 mm THICKNESS



CREMA DELICATO
POLISHED
6 mm THICKNESS



TAVOLINO TORNIO MEDIO (FIG.158.1)



TAVOLINO TORNIO GRANDE (FIG.158.2)



TAVOLINO CUBO GRANDE (top) PICCOLO (bottom) (FIG.159.1)

TAVOLINO CUBO

Tavolino Cubo, a luxurious furniture piece that exudes sophistication and elegance. Handcrafted by skilled artisans using only the finest materials, this versatile piece can be used as a coffee, side, or occasional table. Showcasing a striking contrast of light and dark colourways, its clean lines and minimalist design make it the perfect centerpiece for any luxurious interior. Customise your own unique piece with a variety of finishes and colour combinations available upon request.

SPECIFICATION

Grande (mm) (tolerance ± 2 mm)	Length (L): 1200 Depth (D): 1200 Height (H): 200
Medio (mm)	Length (L): 1200 Depth (D): 600 Height (H): 350
Piccolo (mm)	Length (L): 600 Depth (D): 600 Height (H): 350



DEEP NORWAY
POLISHED
6 mm THICKNESS

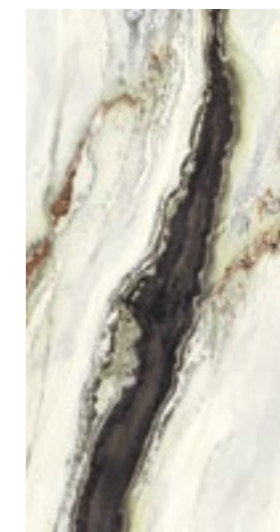

PANDA WHITE
POLISHED
6 mm THICKNESS



TAVOLINO CUBO GRANDE (FIG.160.1)



TAVOLINO CUBO MEDIO (FIG.160.2)









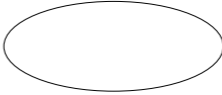

TOV-TT04 TABLE TOP (FIG.161.1)

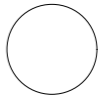
TABLE TOP CONFIGURATION

Italian porcelain surfaces are available as luxurious and elegant table tops and table inlays. Known for their durability and timeless beauty, and with a wide selection of colours and styles to choose from, each top boasts its own delicate veining and unique patterns. There is a choice of three finishes including Polished, with its high shine, Honed which adds a soft sheen, or Natural with its delicate textures, each adding an air of sophistication and refinement. Please note that if you are supplying your own base, porcelain table tops are extremely heavy and require a very sturdy support.

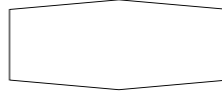
CONFIGURATION

Model	TOV-TT01	TOV-TT03	TOV-TT02
			
Maximum Dimensions	2900 x 1400 mm	2900 x 1400 mm	1400 x 1400 mm
	TOV-TT04	TOV-TT06	TOV-TT07
			
Maximum Dimensions	2900 x 1400 mm	2900 x 1400 mm	1400 x 1400 mm
	TOV-TT08	TOV-TT09	TOV-TT11
			
Maximum Dimensions	2900 x 1400 mm	2900 x 1400 mm	2900 x 1400 mm

*Other colours available in 6, 12 and 20 mm thicknesses



TABLE TOP PROFILES (FIG.162.1)

TABLE TOP PROFILES

12 and 20 mm thickness table tops can be specified with a choice of edge profiles:

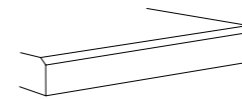

BEVELLED EDGE

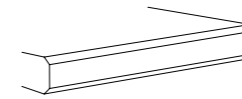

DOUBLE BEVELLED EDGE

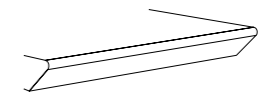

SHARK NOSE EDGE

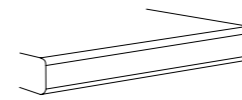

DOUBLE PENCIL EDGE

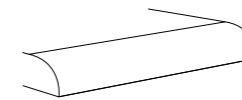

HALF BULLNOSE EDGE

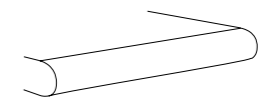

BULLNOSE EDGE

PROFILE BANDING OPTIONS

Table tops can be specified with an attractive and durable metal banding edge. Banding is available in a choice of six metallic colours that can be used to complement or contrast with the chosen surface design. Banding can be specified between 40 to 100 mm in thickness for table tops.

Profile banding [90° Metal Banding]

Banding colour [Brushed Copper][Brushed Bronze][Brushed Gold]

[Brushed Inox][Satin Black][Decorative Bronze]

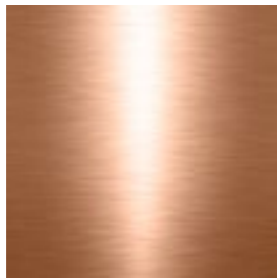

BRUSHED COPPER



BRUSHED BRONZE



BRUSHED GOLD



BRUSHED INOX



SATIN BLACK

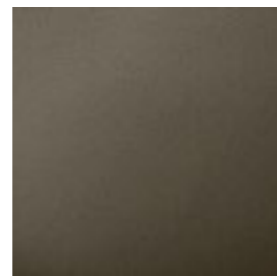

DECORATIVE BRONZE

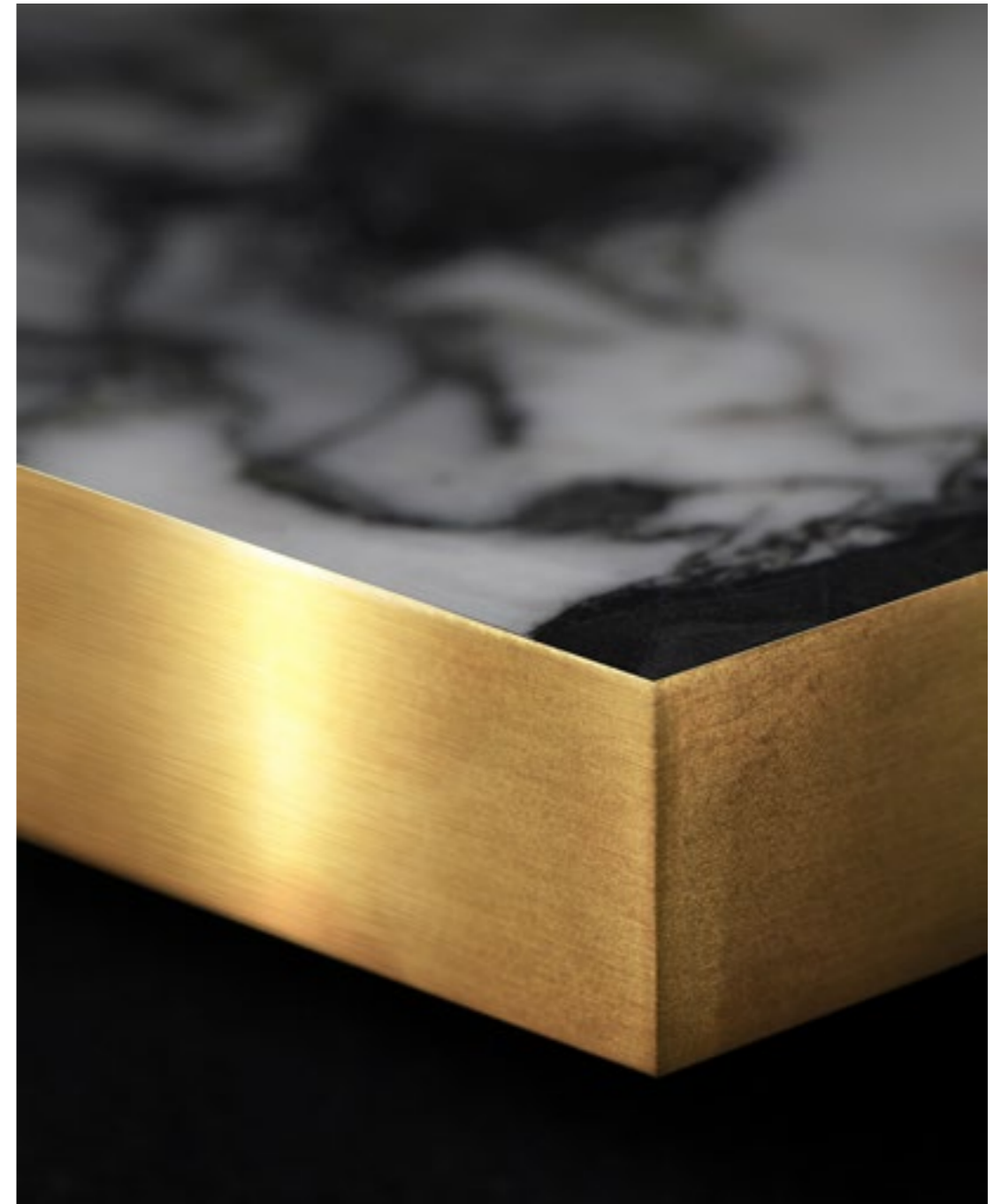

GOLD METAL BANDING (FIG.163.1)



PODIUM (FIG.164.1)

PODIUM

Podium is four or six-sided plinth which can also be used as a low table or seating unit. Present object d'art or sculptures in all their glory, Podium can also be specified as a planter with a shallow base ideal for orchids and other statement plants. Use within bathrooms, public places, galleries, or hotel lobbies.

SPECIFICATION

Model Podium

Height (H): 150-1200
Width (W): 200-500
Depth (D): 200-500

PLANTER OPTION

Top plate [Fixed][Planter]

Top plate depth (mm) 80-200



TAVOLINO ORIGAMI (FIG.165.1)



LIVING ROOM LUXURY:
DINING TABLES THAT
ELEVATE YOUR SPACE

TAVOLO MEZZALUNA VENEZIANA (FIG.166.1)

KITCHEN COUNTERTOPS

Remodel kitchen islands and countertops with a brand new porcelain worktop. Install precision cut high-performance worktops from a choice of over one hundred stunning colours and styles. Upgrading existing kitchen worktops is easy... Select your chosen surface from our extensive collection of Italian Porcelain. Then schedule an appointment to carry out a detailed laser templating of the project site. When the new top is ready, we send our installation team to deliver and install it. The entire process is stress free, and because we take care of the entire process from templating, manufacturing to installation, it is also totally risk free.

COUNTERTOP DATA SHEET

Length (L)	∞ (Max 3200 mm without a join)	
Depth (D)	651 - 1500 mm	
Thickness (T)	12 mm	20 mm
Approximate weight	29 kg per m ²	45 kg per m ²
Edge profile	See Edge Profiles	
Configurable options	Options for cut-outs, integrated sink and tap holes	



20 MM ISLAND COUNTERTOP (FIG.167.1)



12 MM ISLAND COUNTERTOP (FIG. 168.1)



12 MM ISLAND COUNTERTOP AND WORKTOP (FIG.169.1)



20 MM ISLAND COUNTERTOP AND WORKTOP (FIG.170.1)



20 MM COUNTERTOP WITH INTEGRATED SINK AND DRAINER GROOVES (FIG.171.1)

PORCELAIN SURFACES REDEFINED

The products presented in this catalogue are available in a wide range of colours and styles. All colours can be paired with matching large format Italian porcelain slabs for walls and floors. Porcelain slabs are the latest generation of surface materials that combine lightweight design with increased technical performance. These slabs redefine conventional

size rules, with 160 x 320 cm formats that offer unparalleled versatility for ambitious design schemes. Additional formats measuring 120 x 280 cm have been introduced to provide practical solutions for walls, minimising waste and eliminating the need for cutting during installation. With a thickness of just 6 millimetres, these porcelain slabs can be seamlessly

used for flooring, wall cladding, or fixed to any vertical or horizontal surface including upstands and skirting. The result is an easy-to-install, continuous flat surface with minimal grout lines and maximum decorative impact.



CLASSIC MARBLE EFFECT SURFACES



BIANCO STATUARIO
NATURAL | POLISHED



BREACH
NATURAL | POLISHED



STATUARIO ULTRA
NATURAL | POLISHED

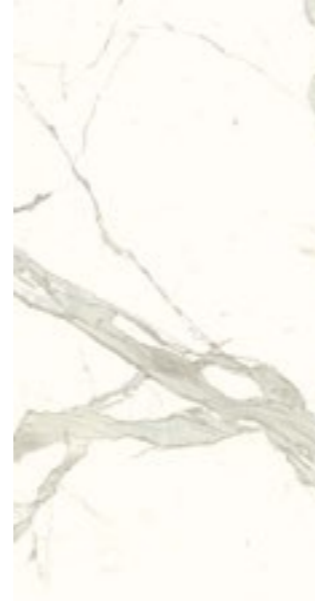

BIANCO CALACATTA
POLISHED | NATURAL | SILK

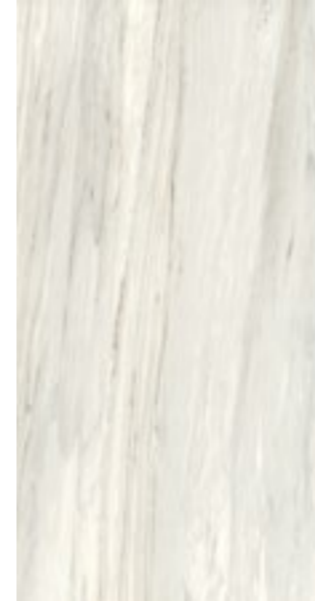

CREMA DELICATO
NATURAL | POLISHED



TRAVERTINO VEIN WHITE
NATURAL



PREMIUM WHITE
POLISHED | SILK | NATURAL

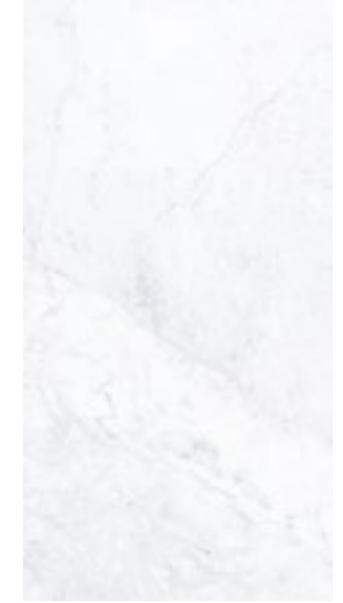

MICHELANGELO ALTISSIMO
NATURAL | POLISHED



CALACATTA VIOLA
NATURAL | POLISHED



DARK EMPERADOR
POLISHED

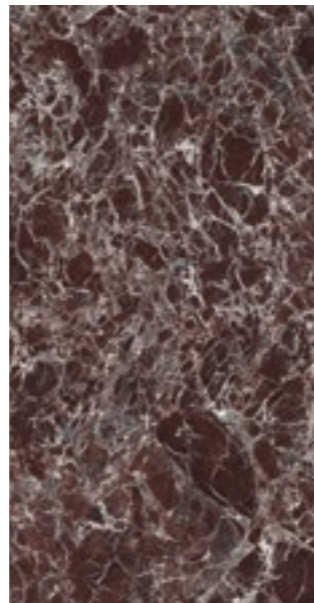

ROSSO IMPERIALE
NATURAL | POLISHED

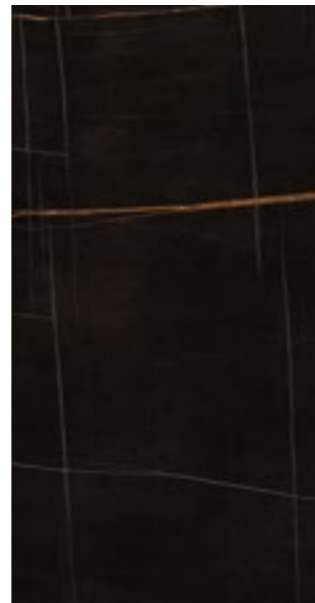

SAHARA NOIR
POLISHED | SILK

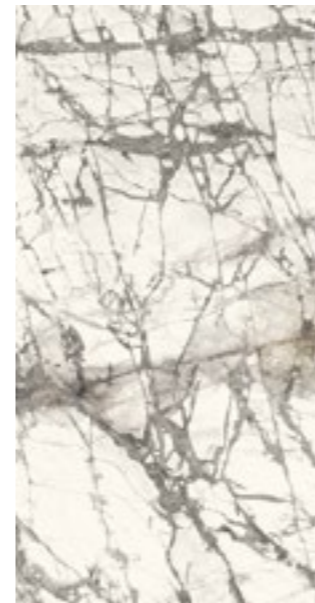

IMERIAL GREY
NATURAL | POLISHED

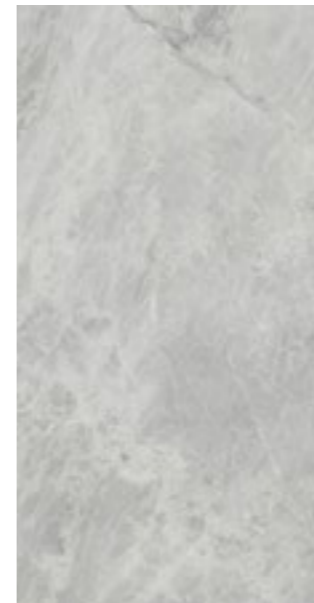

GRIS DE SAVOIE
NATURAL | POLISHED



GRIGIO CARNICO
POLISHED



GREY MARBLE
NATURAL | POLISHED

CLASSIC ONYX & MARBLE EFFECT SURFACES

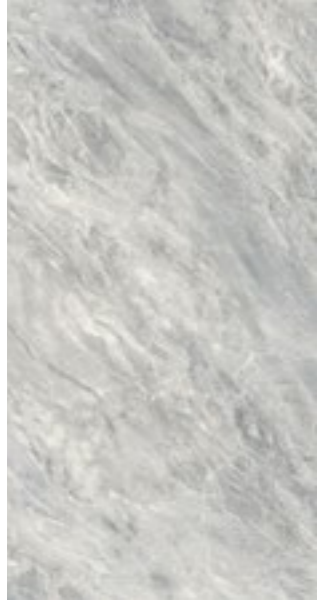

BARDIGLIO CHIARO
NATURAL | POLISHED



ONICE GRIGIO
NATURAL | POLISHED



REVE PERLE
POLISHED | NATURAL



REVE JADE
POLISHED | NATURAL

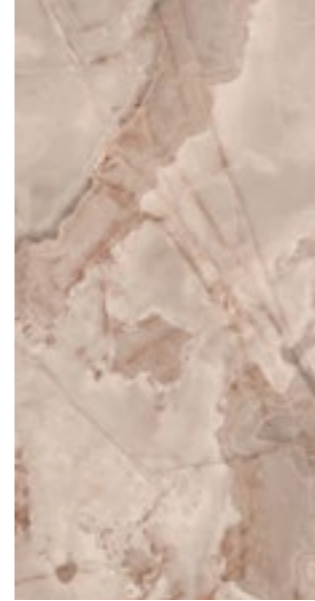

REVE ROSE
POLISHED | NATURAL



REVE NOISETTE
POLISHED | NATURAL



REVE CHOCO
POLISHED | NATURAL

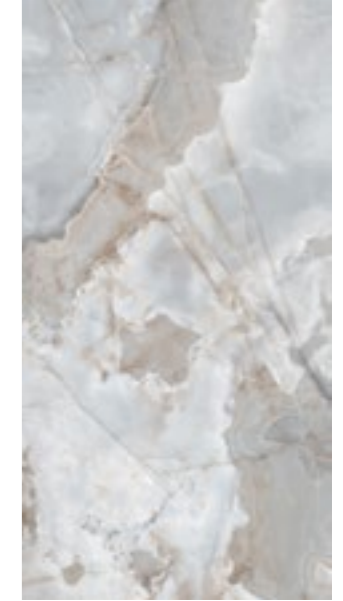

REVE BLEU
POLISHED | NATURAL



MOON GREY
POLISHED

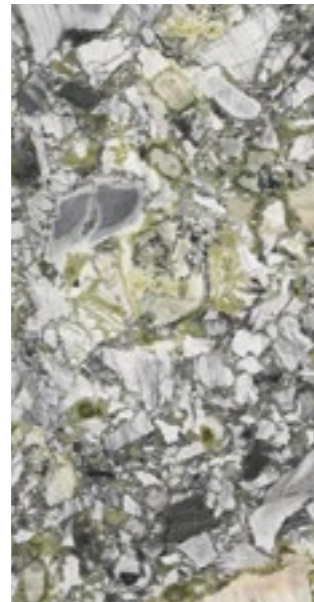

WHITE BEAUTY
POLISHED



BRILLIANT GREEN
POLISHED



VERDE KARZAI
POLISHED

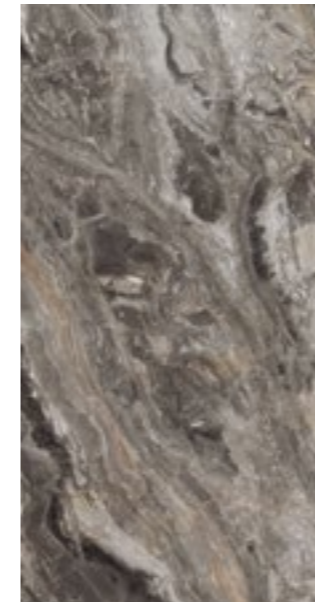

ARABESCATO OROBICO
POLISHED

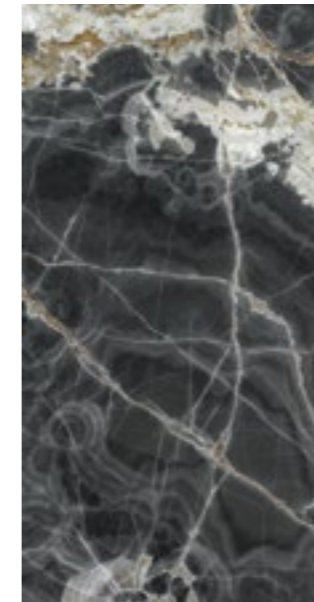

ONICE NERO
POLISHED

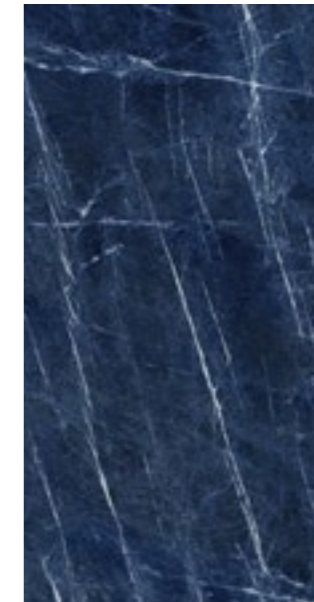

SODALITE BLU
POLISHED

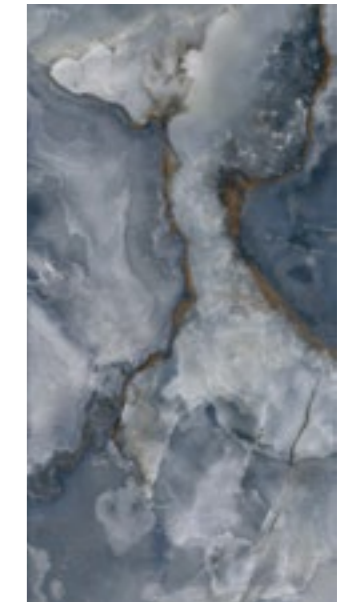

ONYX BLUE
POLISHED

CONTEMPORARY GRANITE & STONE EFFECT SURFACES



AGATA BLU
POLISHED



AGATA ATENA
POLISHED



AGATA BLACK
POLISHED



AMAZONITE
POLISHED

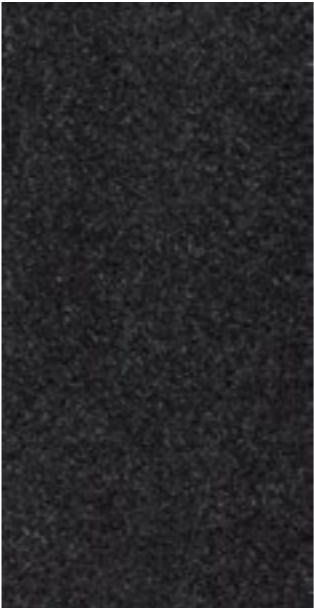

DEEP NORWAY
POLISHED



LABRADORITE
POLISHED



ALASKA WHITE
SILK | NATURAL



CELESTE ARAN
SILK | NATURAL



CRYSTAL DARK
POLISHED



CRYSTAL SKY
POLISHED



GREY ROCK SALT
POLISHED



BROWN ROCK SALT
POLISHED



PIETRA GREY
POLISHED | SILK | NATURAL



PALLADIUM GREY
NATURAL



PIETRA PIASENTINA
SILK | STRUCTURED



JATOBA BROWN
SILK

EXQUISITE WOOD EFFECT SURFACES



EMINENT GREY
POLISHED | SILK



PLANK_04
NATURAL



PLANK_05
NATURAL



PLANK_06
NATURAL



EMINENT BROWN
POLISHED | SILK



PLANK_01
NATURAL



PLANK_02
NATURAL



PLANK_03
NATURAL

SUSTAINABILITY

All porcelain surfaces are manufactured using sustainable processes that minimise environmental impacts, conserving energy & natural resources. Produced without the use of any harmful or radioactive materials, no hazardous emissions are emitted and they will not affect air quality. All waste material that is associated with the supply of the tile surface

is fully recyclable and all packing material is produced with recycled material. This means that all surfaces have a reduced environmental impact throughout their lifespan. With no toxic or polluting substances used in their composition and production they meet the highest standards of quality and environmental regulations, conforming to the following certifications:



BREEAM®



CONTACT

design@tailormade.uk

020 3848 5212

tailormade.uk

@tailormadeuk

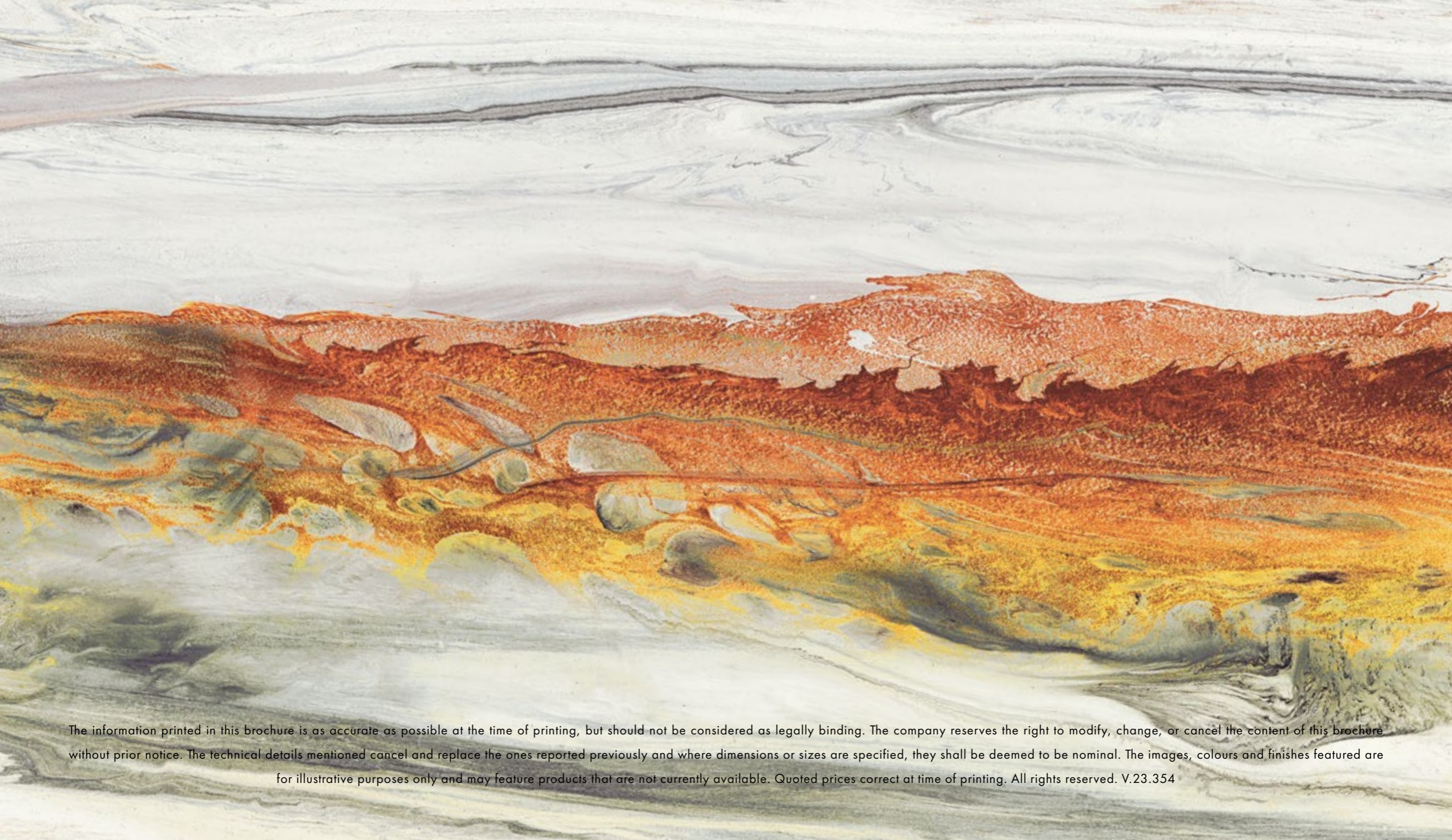

The information printed in this brochure is as accurate as possible at the time of printing, but should not be considered as legally binding. The company reserves the right to modify, change, or cancel the content of this brochure without prior notice. The technical details mentioned cancel and replace the ones reported previously and where dimensions or sizes are specified, they shall be deemed to be nominal. The images, colours and finishes featured are for illustrative purposes only and may feature products that are not currently available. Quoted prices correct at time of printing. All rights reserved. V.23.354