

Soundtect®

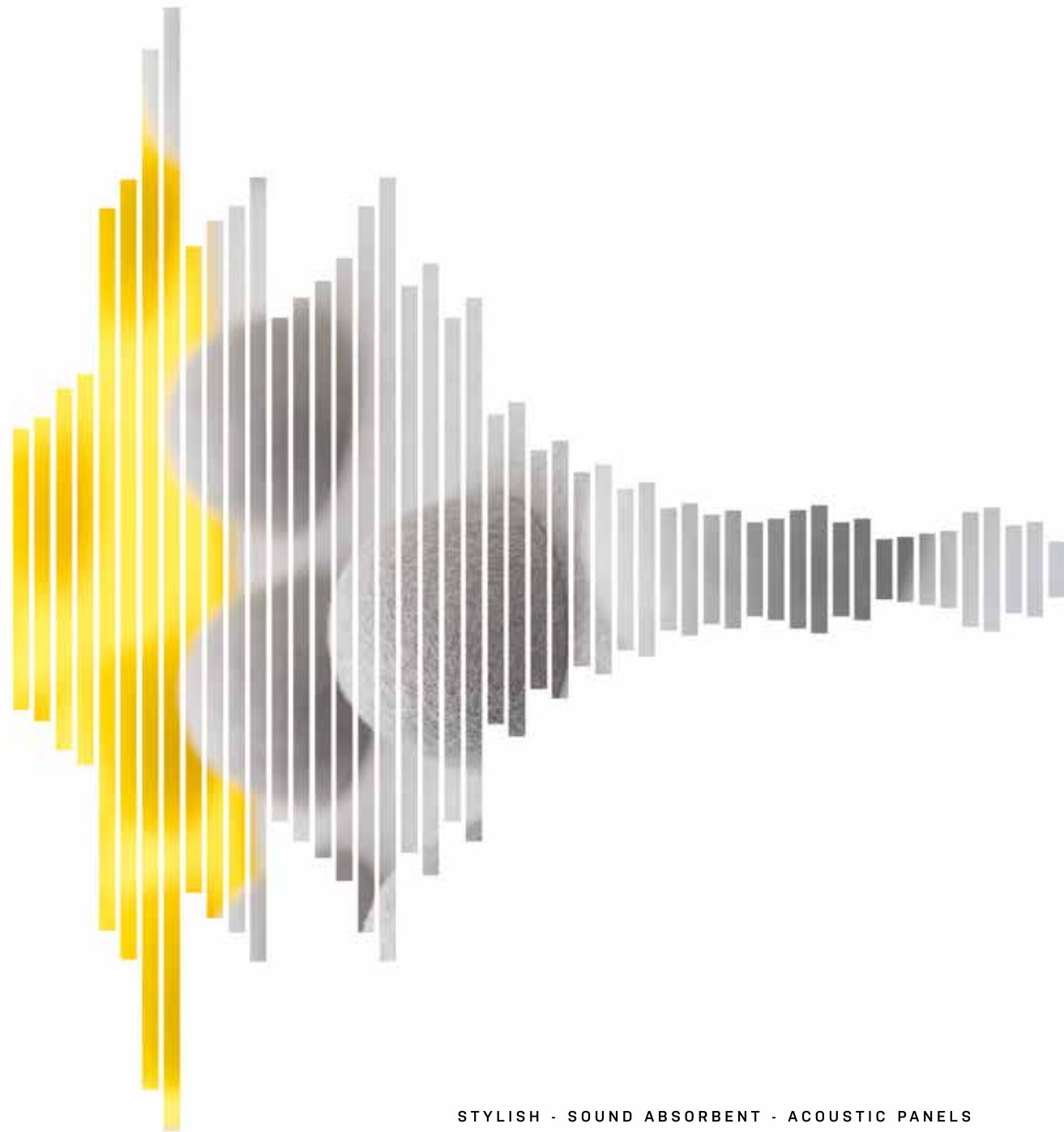

STYLISH - SOUND ABSORBENT - ACOUSTIC PANELS



Contents

4	WHAT WE DO	FS	IO	3D	C
6	SOUNDTECT AND THE ENVIRONMENT	Freestyle Range	FREESTYLE Rafts Printed Timba Skreen Ripple Harmony Wall Acoura	Soundtect 3D Range	Soundtect Class Range
8	SOUNDTECT SHOWROOM				
		30	WAVE		
		32	FOREST		
		34	PRISM		
		36	CUBISM		
		38	TETRIS		
		40	CLASS CIRCLES		
		42	CLASS WALL PANELS		
		44	CLASS ABOVE RAFTS		
		46	COLOUR PRODUCT CARE		
		48	SPECIFICATION		
		52	INSTALLATION		

what we do

INNOVATIVE SOLUTIONS TO YOUR REVERBERATION ISSUES

Acoustics are now a recognised problem or application in every part of our daily life, from workplace to home, schooling to leisure.

Soundtect has developed products that not only address the issue of reverberation but also add a positive design feature to rooms or areas in both commercial and residential applications.

As a recycled product, Soundtect is an ideal choice for greener projects and with performance levels of up to 1.0 NRC the panels are acoustic to the core.

By creating highly design led panels, Soundtect has camouflaged acoustic function with imagination and produced beautiful patterns that are technically admirable due to their finely tuned balance of reverberation control and sound absorption.

Add this to fine design; a wow factor has entered the room.

DESIGN FLEXIBILITY

Soundtect Acoustic Wall and Ceiling panels are available in 12 eye catching designs in our core 3-D range and Class range that will enhance the interior of any project. Soundtect Acoustic 3-D panels are readily available in 16 colours, Freestyle is available in 22 to compliment any project.

With the ability to offer a far greater range of colours based on quantity, Soundtect are also the perfect choice for more bespoke applications.

GREEN CREDENTIALS

Soundtect Ltd. is very proud of its environmentally friendly approach to acoustics. Using 70% recycled polyester; Soundtect acoustic panels are a 3rd generation product which began life as PET bottles. Not content with manufacturing this product into exhibition carpets for their second short term use, we felt they still didn't comply with our environmental values. So the carpet fibres were reused and layered in a unique way to create our highly efficient acoustic felt and Soundtect Acoustic panels were born.

PERFORMANCE GUARANTEED

Soundtect Acoustic panels are all tested to British and European Standards for both fire and acoustics. We are consistently ensuring that tests for every product are current and valid.

Soundtect are happy to provide certification upon request giving you peace of mind when it comes to specifying and installing Soundtect Acoustic panels.

APPLICATION SOLUTIONS

Education, Offices, Retail, Leisure, Hotel, Restaurant, Public Health, Commercial and Domestic. Soundtect Acoustic Panels provide up to 1.00 NRC and are easily installed making them the perfect acoustic solution.

The nature of this product ensures it is non-toxic, and is therefore guaranteed not to irritate or react with allergies.

PROJECT SUPPORT

Soundtect experts would be delighted to assist you with all stages of your project from working on your design with an architect to in-house installation support. Soundtect staff will work closely with you to ensure project satisfaction.

soundtect and the

environment

Sustainability is about more than simply looking after the environment.



Soundtect has been manufacturing a wide range of acoustic solutions for 13 years using post-consumer recycled PET to manufacture their products. All the products have been certified sustainable by Global Green Tag with a Platinum certification for Asthma and Allergy sensitive credentials.

Global GreenTag is one of the world's most robust, trusted and widely recognised eco labels. "We independently assure that every product is fitness tested and certified under one of our two leading certification programs that use the world's best scientific methods. That's why we have earned the reputation and trust of thousands of buyers, hundreds of companies and numerous green building councils, certification bodies and governments around the world"



bit.ly/42zF3R0

Please visit Global Green Tag to see the products certified using the QR code above.

Full certificates available on request.

over
70%
recycled polyester

With companies looking extensively at green options for their new offices, Soundtect credentials means that we are frequently specified for projects demanding high levels of sustainable design. Soundtect is very proud of its environmentally friendly approach to acoustics.

70% recycled polyester, the panels are a third generation product which began life as a plastic PET bottle. Not content with turning this product into exhibition carpets for their second use, the panels were designed after it became clear that one use for exhibitions was a real issue in our companies' environmental beliefs.

Using a careful and effective way of layering the recycled fibre from used carpets, a superior quality, high performance acoustic felt was born. A design team was brought in to create the fabulous designs that are now instantly recognisable and through Soundtect the face of acoustics changed forever.

Soundtect has a UK warehouse containing a large quantity of Class and 3D stock. The Freestyle is shipped per order due to the uniqueness of each order, but we do request enough time where possible to ship by sea freight. This also relates to non-stocked colours in the Class and 3D range too.

a superior quality, high performance **acoustic felt was born**



8 showroom/

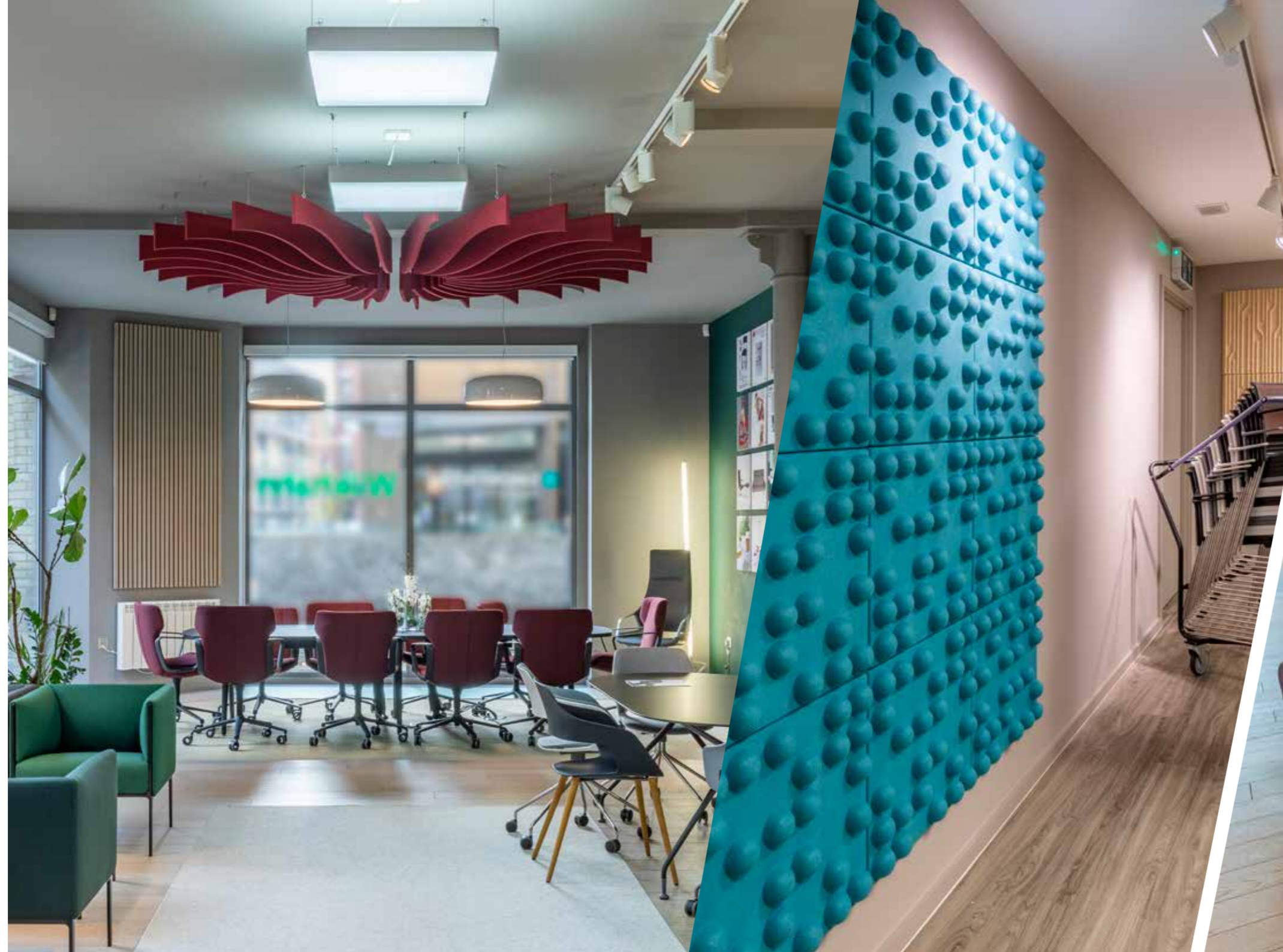

showroom

www.soundtect.com

9

freestyle

Discover the stylish, versatile and aesthetic freestyle



Soundtect's Freestyle™ Panels are architecturally inspired and can be used to create stunning, utterly modern wall and ceiling designs in a range of colours and finishes.

The contemporary design is suited to a range of commercial applications and ensures effective acoustic management whatever the space.



rafts



Exceptional levels of acoustic performance



Baffles are engineered acoustical products giving exceptional levels of acoustic performance. Ideal for noisy environments where traditional acoustic ceilings are not possible.

The Baffles and rafts are installed using our unique suspension cable system allowing for easy installation and removal.

The fins are installed via circular hooped bolts with can be attached either to a suspended frame system or to hooks directly on the ceiling. For wall applications, the panels have an internal system to create a floating finish.





freestyle printed

With up to 70% recycled content and finely tuned reverberation and sound control, Freestyle™ is the natural choice for bespoke designs that challenge the status quo.



timba

Developed by London-based Soundtec®, Freestyle™ panels are built to exacting quality and use all of Soundtec's pioneering acoustic know-how.



skreen

Lightweight and easy to install acoustic application creating visual movement and eye catching features to walls and ceilings, whilst addressing the problem of reverberation. The panels are easily wall mounted to create bespoke feature walls that absorb sound and enhance sound quality.

Understated Elegance.
Add a new dimension to your environment



20

Freestyle/FS

ripple

The Soundtect Ripple: Gently curved semi circular tubes of superior acoustic felt, affixed to walls for a stunning rippled wall effect, with superb acoustic qualities.

The easily installed design is suited to a range of commercial applications and ensures effective acoustic management whatever the space. Each strip, up to a maximum 2400mm length, can be cut into various widths of choice.

Understated Elegance.
Add a new dimension to
your environment



www.soundtect.com

21

freestyle harmony

Slatted 25mm width x 20mm depth battens are prefixed with 10mm spacing to a backing felt which is super fine allowing easy installation on curved and straight surfaces alike.





freestyle
harmony



wall



The Soundtect Ripple: Gently curved semi circular tubes of superior acoustic felt, affixed to walls for a stunning rippled wall effect, with superb acoustic qualities.

The easily installed design is suited to a range of commercial applications and ensures effective acoustic management whatever the space. Each strip, up to a maximum 2400mm length, can be cut into various widths of choice.

Understated Elegance.
Add a new dimension to
your environment



acoura

The Soundtect Acoura: The easily installed design is suited to a range of commercial applications and ensures effective acoustic management whatever the space. Each strip, up to a maximum 2400mm length, can be cut into various widths of choice.

Understated Elegance.
Add a new dimension to
your environment





3D wave

Fluid and intriguing with its deep undulating curves and dips

Fluid and intriguing with its deep undulating curves and dips, Wave brings movement and life to walls, making it a true feature in any room. The depth of panel is designed to give it a high absorption of sound resulting in a super-efficient 1.00 NRC.

Made from 100% polyester, with over 70% recycled content. The panels can also be recycled making them an incredible environmentally friendly product.



3D forest

Forest is the latest addition to the Soundtect range, emulating nature's greatest gift. The depth of panel is designed to give it a high absorption of sound resulting in a super-efficient 0.95 NRC.

Forest offers a bold linear design, with its curved surface and deep channels offering a superb diffusion quality to the design.

16 standard colour options makes these panels versatile enough to be used in any environment from schools to offices. Forest provides a pattern that lends itself to any indoor space.



Taking **inspiration** from nature



3D prism

Soundtect Prism panels reduce reverberation by offering Class A absorption to increase speech intelligibility in a specific area while reducing background sound noise levels.

The panels are easy to install; either wall mounted or used to create floating ceilings that absorb sound and enhance sound quality.

Soundtect offers design options that are unusual and stand out, giving designers more choice and flexibility for acoustic applications.



increase speech intelligibility in a specific area





3D cubism

fantastic acoustic properties and asymmetrical design



This design is versatile enough to be used in any environment from schools to offices with its four differently levelled plains in one panel.

Cubism not only has fantastic acoustic properties but the asymmetrical design offers the user the ability to use 16 units in a square before repeating the pattern.

3D tetris

a fusion of geometry and raised spheres



In a fusion of geometry and raised spheres. Tetris combines art with function in this fascinating wall ensemble, easily adapting to both residential and commercial settings.

• CLASS circles

Soundtect proudly includes Class Circles in this range of acoustic panels. Offering understated elegance for ceiling applications, Class Circles add a new dimension to absorbing sound reverberation and increasing speech intelligibility.



Understated Elegance. Add a new dimension to your environment



CLASS wall panels

Manufactured from the same environmentally friendly material as the highly desirable range of Soundtect 3D panels, the all new Soundtect CLASS range is also complimented by "CLASS ABOVE" a stunning range of baffles and rafts. Undoubtedly the most cost effective high quality high performance wall panels, baffles and rafts welcomed by many clients globally.

highly absorbent range
of Class wall panels



CLASS above rafts



Baffles are engineered acoustical products giving exceptional levels of acoustic performance. Ideal for noisy environments where traditional acoustic ceilings are not possible.

The Baffles and rafts are installed using our unique suspension cable system allowing for easy installation and removal.

The fins are installed via circular hooped bolts with can be attached either to a suspended frame system or to hooks directly on the ceiling. For wall applications, the panels have an internal system to create a floating finish.

Exceptional levels of
acoustic performance

Standard Colour Range

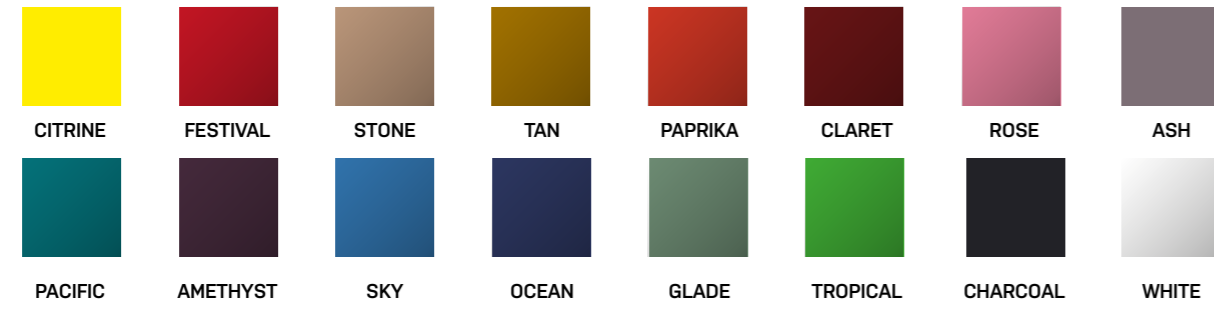

Please note that some of the above colours are a special order and will therefore have a longer lead time than others.

Please contact our office at: admin@soundtect.com for clarification.

This colour chart is for reference only. Based on our policy to use recycled fibres, it's a natural property that different batches of colour will vary.

CLASS Colour Range



Freestyle Colour Range

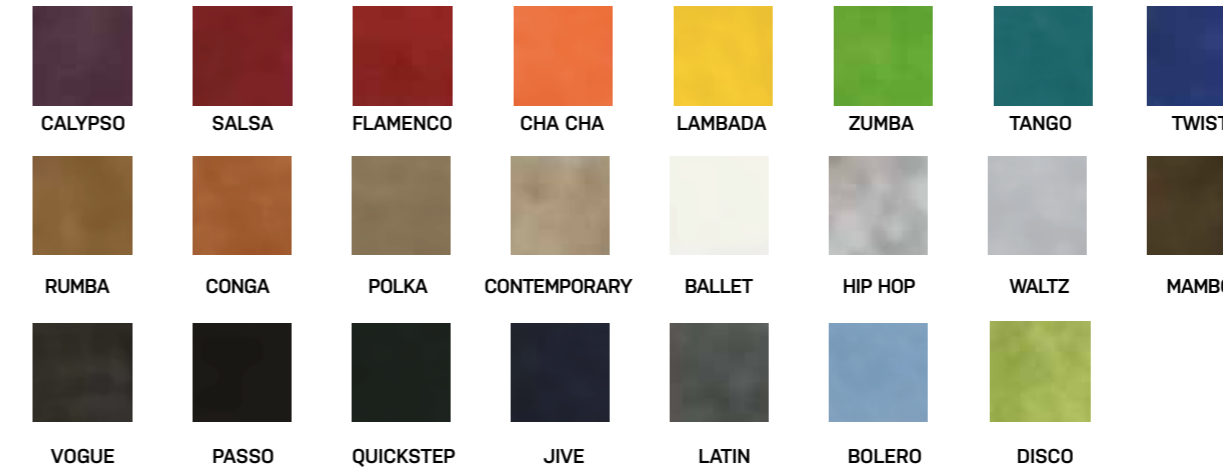

PRODUCT CARE

Simply use soap and water or specific carpet cleaner to remove stains or marks.

The panel should be blotted first to remove surface spills and then gently cleaned with a soft clean cloth, taking care not to rub excessively or use excess water.

3D Colour Range



NATURES PALATTE

A new collection of colours for the 3D range representing nature's glory.

Soundtect acoustic panels offer design options that are unusual and stand out, giving designers more choice and flexibility for acoustic applications.

The panels are easily wall mounted and can be used to create floating ceilings that absorb sound and enhance sound quality.

Reverberation is reduced by offering Class A absorption to increase speech intelligibility in a specific area while reducing background sound noise levels.

Soundtect panels are for indoor use only but can be used in any area that acoustic treatments are required including areas of high levels of humidity such as swimming pools, as polyester fibre showed only 0.03% absorption of moisture during recent testing where panels were subjected to high humidity of 90% for a five day period. Moisture does not affect polyester and is therefore safe in all indoor applications.

All Soundtect products comply with British Standard regulations

Fire Class Testing

Soundtect Panels achieved Class BS1 D0, this makes Class Circles suitable for use in Class 1 and Class 0 requirements.

Acoustic Performance

Soundtect Panels offer excellent sound absorption properties. The Laboratory Measurement of Random Incidence Sound Absorption to BS EN ISO 354:L2003.

Standard Colours & Special Colours

- Not all colours shown are held in stock but they are available within 2-12 weeks.
- Please contact our office enquiries@soundtect.com for clarification.
- A further selection of colours are available in our Special Range.
- Prices and lead times will vary depending on quantity.

Specifications

Wave

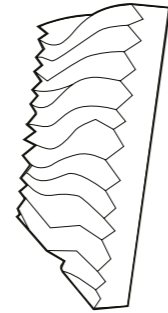

Specifications

- Product size 600 x 600 x 75mm
- Composition 100% polyester fibre (PET) 70% recycled
- NRC 1.0
- Fire Class BS1 D0 (UK Class 1)

Forest

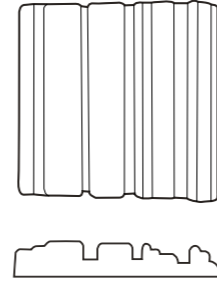

Specifications

- Product size 600 x 600 x 75mm
- Composition 100% polyester fibre (PET) 70% recycled
- NRC: 0.95
- Fire Class: BS1 D0 (UK Class 1)

Prism

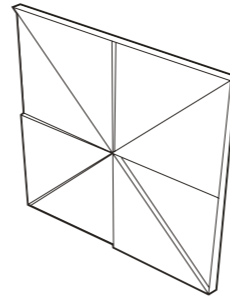

Specifications

- Product size 600 x 600 x 50mm
- Composition 100% polyester fibre (PET) 70% recycled
- NRC: 0.90
- Fire Class: BS1 D0 (UK Class 1)

Cubism

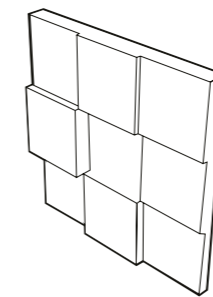

Specifications

- Product size 610 x 610 x 50mm
- Composition 100% polyester fibre (PET) 70% recycled
- NRC: 0.90
- Fire Class: BS1 D0 (UK Class 1)

Tetris

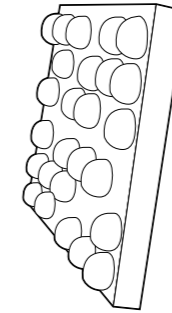

Specifications

- Product size 460 x 460 x 40mm
- Composition 100% polyester fibre (PET) 70% recycled
- NRC 0.90
- Fire Class BS1 D0 (UK Class 1)

Ripple

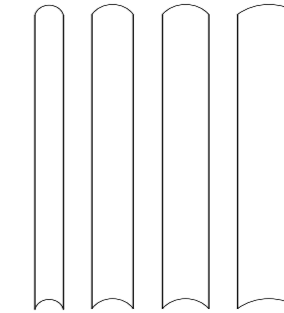

Specifications

- Product size 30 x 2400mm
- 50 x 2400mm
- 60 x 2400mm
- 100 x 2400mm
- More sizes available on request
- Composition 100% polyester fibre (PET) 70% recycled
- NRC expected 0.85 - test results pending
- Fire Class EN13501, Bs1d0

Standard Colours & Special Colours

- All products shown here are available in the colours opposite. Please speak to a Soundtect representative for more detailed information.
- Not all colours shown are held in stock but they are available within 2-12 weeks.
- Please contact our office enquiries@soundtect.com for clarification.
- A further selection of colours are available in our Special Range.
- Prices and lead times will vary depending on quantity.



CITRINE



FESTIVAL



STONE



TAN



PAPRIKA



CLARET



ROSE



ASH



PACIFIC



AMETHYST



SKY



OCEAN



GLADE



TROPICAL



CHARCOAL



WHITE

Class Circles

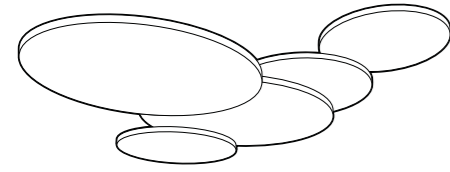

Specifications
 • Product size: 800mm diameter or 1200mm diameter
 • Composition: 100% polyester fibre (PET) 70% recycled
 • NRC: 0.80

Class Panels

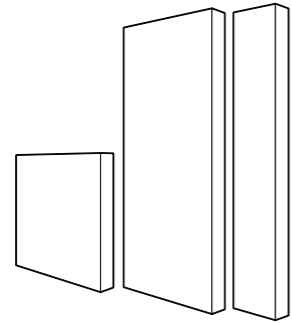

Specifications
 • Product size 1200 x 300mm
 1200 x 600mm
 600 x 600mm
 • Composition: Using the same tried and tested recycled PET bottles as our existing range, 50%+ Recycled
 • NRC: 0.95

Solar rafts

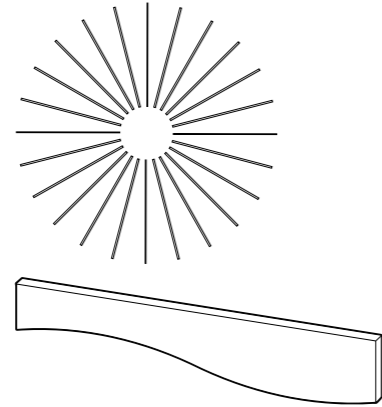

Specifications
 • Product size Set of 26 Wavy 1200 x 300 x 20mm baffles installed to create a 3m 2 ceiling raft
 • Composition: Using the same tried and tested recycled PET bottles as our existing range, 50%+ Recycled
 • NRC: 0.85

Acoura

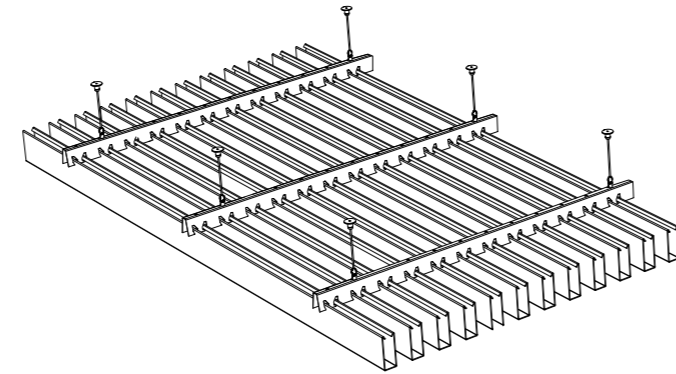

Specifications
 Acoura is available in a variety of sizes. The drawing above is only indicative. Please speak to your Soundtect representative for more details
 • Composition 100% polyester fibre (PET) 70% recycled
 • Fire Class EN13501, Bs1d0

Kork

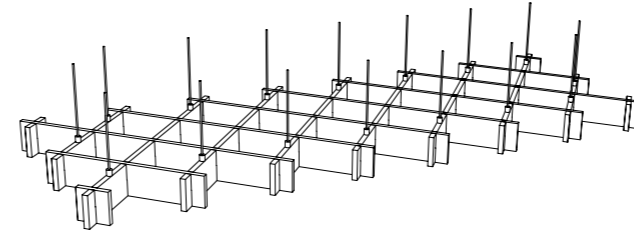

Specifications
 Kork is available in a variety of sizes. The drawing above is only indicative. Please speak to your Soundtect representative for more details
 • Composition 100% polyester fibre (PET) 70% recycled
 • Fire Class EN13501, Bs1d0

Kris Kros

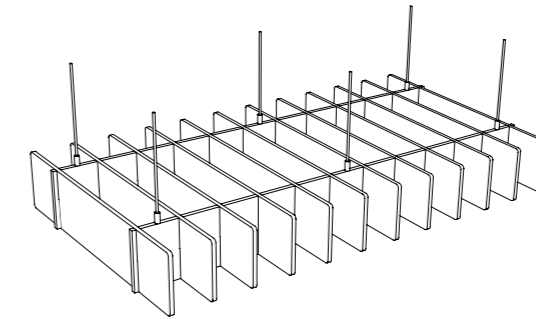

Specifications
 Kris Kros is available in a variety of sizes. The drawing above is only indicative. Please speak to your Soundtect representative for more details
 • Composition 100% polyester fibre (PET) 70% recycled
 • Fire Class EN13501, Bs1d0

Krest

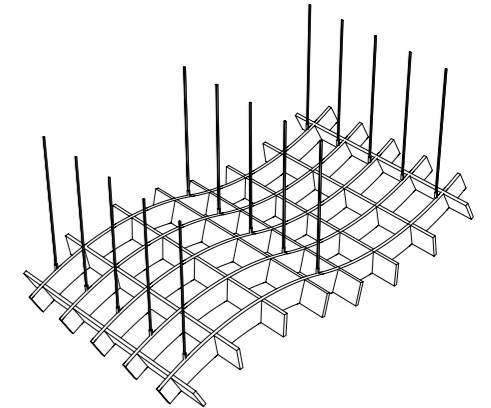

Specifications
 Krest is available in a variety of sizes. The drawing above is only indicative. Please speak to your Soundtect representative for more details
 • Composition 100% polyester fibre (PET) 70% recycled
 • Fire Class EN13501, Bs1d0

Colours



Colours



Colours Freestyle Colour Range



installation

Your Soundtect panels can be installed by our expert engineers.

Soundtects simple installation methods are suitable for all types of buildings and surfaces. Allowing for versatile acoustic sound proofing in any building, large or small.

Soundtect products are installed using four methods.

WALL MOUNTED BRACKETS

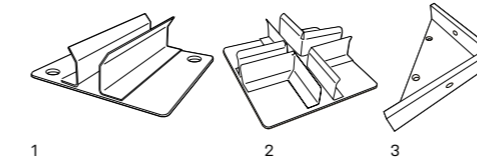

Draw a grid of your panel configuration.

Screw wall brackets in place making sure to use the correct bracket for the number of panels.

We supply three types of bracket:

- Corner brackets
- Two panel brackets
- Four corner brackets

1. Two Panel Bracket 2. Four Panel Bracket 3. Corner Bracket



'L' WALL MOUNTED BRACKETS

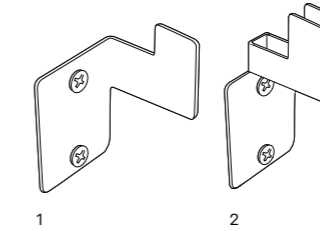

Simply screw the 'L' mounted wall brackets to your desired surface.

Align the panel slit against the bracket.

Gently slide the panel onto the 'L' bracket.

Pull panel downwards to secure.

1. L Bracket 2. Double L Bracket



CEILING ANCHORS

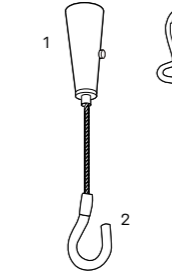

Install the ceiling anchor.

Insert CLASS ring into pre-formed hole on the rear of the panel.

Attached suspension cable and adjust depth.

Hang panel.

1. Ceiling Anchor 2. Suspension Cable 3. CLASS Ring



CEILING HUNG HOOPED BOLTS

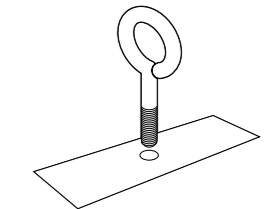

Fins are installed to ceilings via circular hooped bolts.

Attached to a suspended frame system or to hooks directly on the ceiling.



Soundtect®



T | +44 (0) 20 3040 2939 E | enquiries@soundtect.com W | www.soundtect.com

45 Great Sutton Street. London. EC1V 0DE