

Interface

Torque Transducers

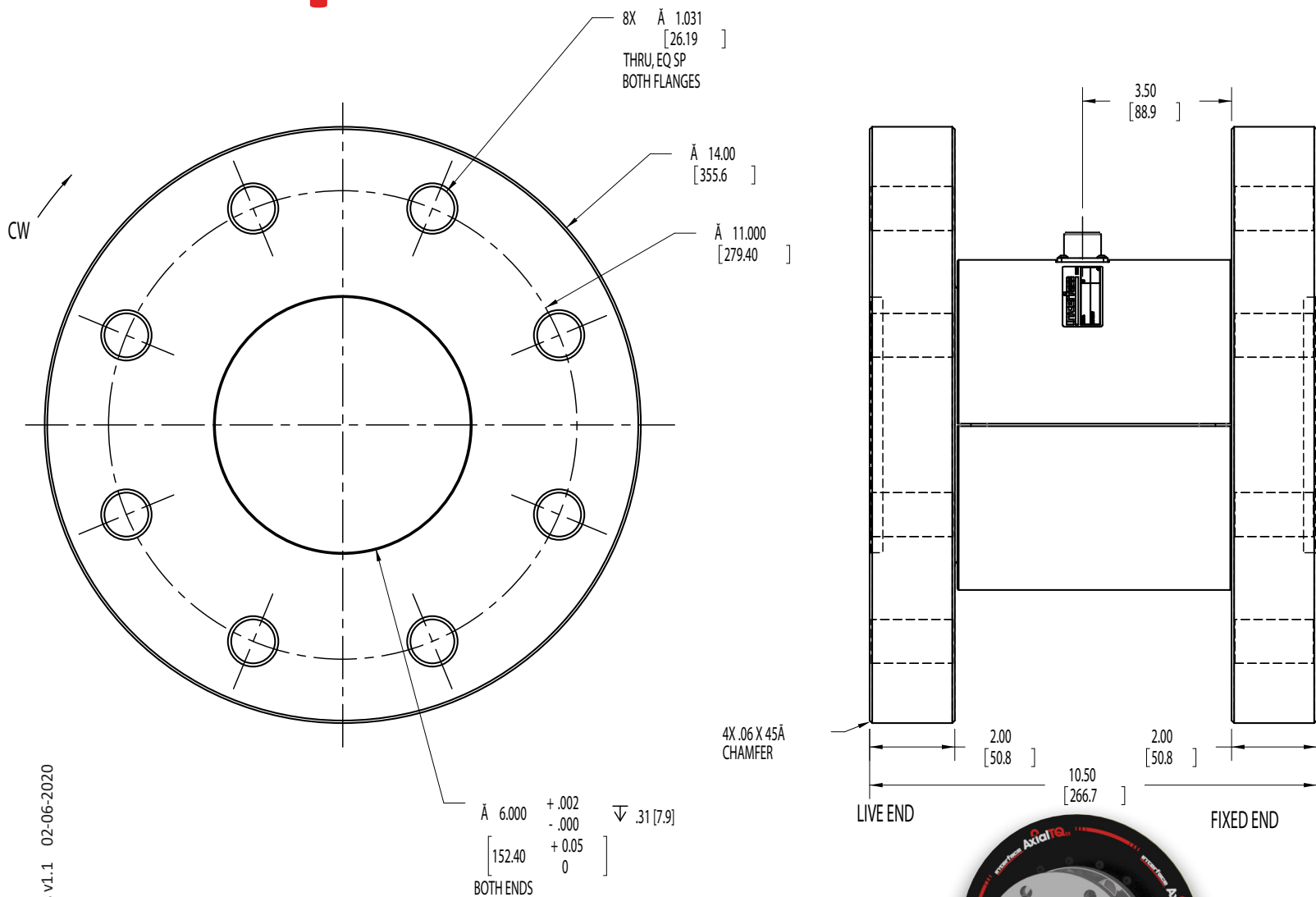

Torque Transducers v1.1 02-06-2020



Interface produces more than 50 types of reaction torque transducers and rotary torque transducers.

All our torque transducers are precision-machined and use our proprietary torque sensors for the most accurate data possible. A torque sensor, is a transducer that converts a torsional mechanical input into an electrical output signal. A reaction torque sensor measures static torque, and rotary measures dynamic torque. Rotary torque transducers are used in applications where the torque transducer must rotate when attached to a spinning shaft. A rotary torque transducer provides a method of getting the signal off of the rotating element without an attached cable. We can help you find mounts from pedestals to shafts to flanges, and drives vary from hex to square to pulley, with more styles in between.

What is a Torque Transducer?

- Converts a mechanical input of torque to an electrical output signal where the signal is directly proportional to the torque input
- Consists of a metal spring element, or flexure – like a load cell
- Strain gages are bonded to the flexure in a Wheatstone bridge configuration
- Torque applied to the sensor causes bending or shear strain in the gaged area, causing the strain gages to change resistance and generating an output voltage signal proportional to torque

Reaction versus Rotary

Reaction (static) – measures torque without rotating

- Normally has a cable attached to it for supplying excitation voltage to the strain gage bridge and for output of the mV/V signal
- Spinning of the sensor is prevented by the attached cable

Rotary (dynamic) – rotates as a part of a system

- Uses slip rings, rotary transformers, rotating electronics, rotating digital electronics, or radio telemetry to get around the issue of the attached cable
- A reaction sensor is at the heart of every rotary sensor

Shaft vs Flange

- **Shaft** can either – be smooth keyed with keyed shafts coming in either single or double keyed versions
 - **Smooth shaft** – more uniform introduction of the torque into the measuring shaft, ease of assembly and disassembly, zero backlash
 - **Keyed shaft** – simpler, cost less, can suffer from wear due to backlash especially in reciprocating applications
- **Flange** – typically shorter than shaft style, have pilots on their flange faces as a centering feature

Shaft Style Torque

- Convenient mounting with standard shaft style coupling
- Longer installed length than flange style
- Rotating shaft style sensors typically have bearings
- Smooth or keyed shafts available

Flange Style Torque

- Short install length
- Better resistance to overhung moments
- Can be more convenient to mount
- Can be hollow
- Bearingless rotary torque sensors tend to be flange style

Couplings

- Should be used for **ALL** torque installations
- Insure isolation of torque loads
- Prevent error and/or damage from extraneous loads

Single-flex (half)

- Has a single flex point
- Allows only angular misalignment

Double-flex (full)

- Has two flex points
- Allows both angular and radial misalignment

Floating vs Fixed

Floating Mount Installations

- Sensor is supported only by the drive and load side connections (typically single-flex style couplings)
- A flexible strap keeps the sensor from rotating
- Bearingless sensors are always floating mount

Fixed Mount Installation

- Applies only to sensors with bearings
- Involves attaching the sensor housing to a fixed support



AxialTQ[®] Rotary Torque
885 lbf-in to 88.5K lbf-in
100 Nm to 10K Nm

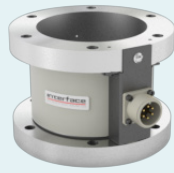

5330 Hollow Flange
60 lbf-in to 100K lbf-in
6.8 Nm to 11.3K Nm



5350 Solid Flange
10 ozf-in to 200 ozf-in
0.07 Nm to 1.4 Nm



5355 Solid Flange
10 lbf-in to 100K lbf-in
1.13 Nm to 11.3K Nm

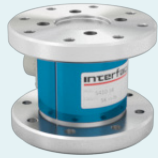

5400 Series Flange Style
1K lbf-in to 500K lbf-in
110 Nm to 55K Nm

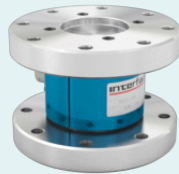

5500 Calibration Grade
2K lbf-in to 300K lbf-in
220 Nm to 33K Nm



MRT Miniature
1.77 lbf-in to 177 lbf-in
0.2 Nm to 2 Nm



MRT2 Miniature
44.3 lbf-in to 443 lbf-in
5 Nm to 50 Nm



**MRTP Miniature
Overload Protected**
1.77 lbf-in
0.2 Nm



**MRT2P Miniature
Overload Protected**
1.77 lbf-in to 17.7 lbf-in
0.2 to 2 Nm

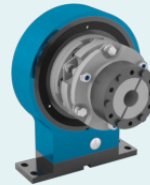

T1 Torque Coupling
400 lbf-in to 9K lbf-in
50 Nm to 1K Nm



T2 Ultra Precision
0.9 lbf-in to 177K lbf-in
0.1 Nm to 20K Nm



**T3 Ultra Precision
Pedestal Mount**
0.88 lbf-in to 177K lbf-in
0.1 Nm to 20K Nm



T4 Standard Precision
0.88 lbf-in to 8.85K lbf-in
0.1 Nm to 1K Nm



**T5 Standard Precision
Pedestal Mount**
0.85 lbf-in to 8.85K lbf-in
0.1 Nm to 1K Nm



T6 Dual Range
44.3/4.43 lbf-in to 4.43K lbf-in to 443K
lbf-in
5/0.5 Nm to 500/50 Nm



**T7 Dual Range
Pedestal Mount**
44.3/4.43 lbf-in to 4.43K lbf-in to 443K
lbf-in
5/0.5 Nm to 500/50 Nm

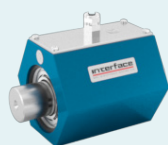

T8 General Purpose
1.77 lbf-in to 1.77K lbf-in
0.2 Nm to 200 Nm

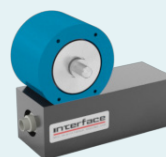

T11 Bearingless
0.04 lbf-in to 1.327K lbf-in
0.005 Nm to 150 Nm

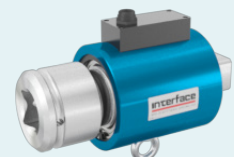

T12 Square Drive
0.88 lbf-in to 44K lbf-in
0.1 Nm to 5K Nm



T14 Slip-Ring
8.85 lbf-in to 4.43K lbf-in
1 Nm to 500 Nm



T15 Hex Drive
1.77 lbf-in to 177 lbf-in
0.2 Nm to 20 Nm

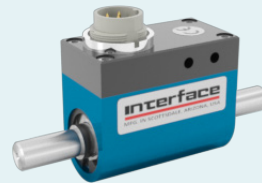

T16 Compact Rotary Torque
8.85 lbf-in to 4.43K lbf-in
1 Nm to 500 Nm

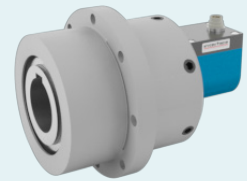

T22 Pulley Belt
177 lbf-in to 44K lbf-in
20 Nm to 5K Nm



T23 Low Cost
2.66K lbf-in to 4.43K lbf-in
300 Nm to 500 Nm



T25 High Speed
0.885 lbf-in to 44.3K lbf-in
0.1 Nm to 5K Nm

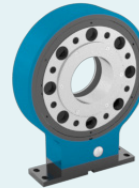

T27 Hollow Flange Bearingless
443 lbf-in to 8.85K lbf-in
50 Nm to 1K Nm

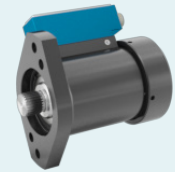

T31, T32, T33, & T34 Spindle Torque
8.85 lbf-in to 4.43K lbf-in
1 Nm to 500 Nm



TR1 Rod End Reaction Torque
25 ozf-in to 1K lbf-in
0.18 Nm to 110 Nm

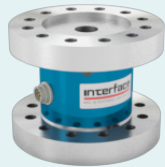

TS11 Flange Style
88.5 lbf-in to 177K lbf-in
10 Nm to 20K Nm



TS12 Shaft Style
0.04 lbf-in to 177K lbf-in
0.005 Nm to 20K Nm



TS14 Square Drive
17.7 lbf-in to 44.2 lbf-in
2 Nm to 5K Nm



TS15 Square Flange Style
17.7 lbf-in to 44.3K lbf-in
2 Nm to 5K Nm



TS16 Square Flange Style
17.7 lbf-in to 17.7K lbf-in
2 Nm to 2K Nm



TS17 Hex Drive
1.77 lbf-in to 177 lbf-in
0.2 Nm to 20 Nm

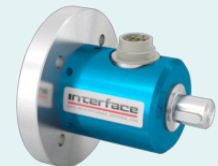

TS18 Shaft to Flange Style
44.3 lbf-in to 17.7K lbf-in
5 Nm to 2K Nm

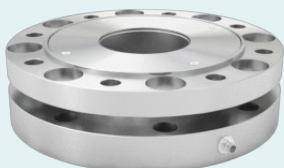

TS19 Short Flange Style
443 lbf-in to 88.5K lbf-in
50 Nm to 10K Nm

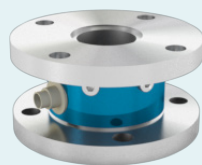

TS20 Hollow Flange
88.5 lbf-in to 1.77K lbf-in
10 Nm to 200 Nm



TS21 Miniature Shaft Style
8.85 lbf-in to 885 lbf-in
1 Nm to 100 Nm



TS22 Low Capacity Overload Protected
0.04 lbf-in to 177 lbf-in
0.005 Nm to 20 Nm

Bearings

Sensors – Bearings vs. Bearingless

- Bearing friction
- Maintain alignment between the rotating and stationary parts of the sensor
- Bearingless – always floating mount – alignment must be maintained

Accuracy and Resolution

- Usually quoted as a percentage of Capacity
- A common rating is 0.1% combined error
- For example: a 100Nm sensor with 0.1% combined error – will have +/- 0.1Nm error
- Other considerations:
 - Temperature error
 - Noise and resolution
 - Measurement Bandwidth – sample rate
- There is **ALWAYS** a compromise between accuracy and resolution as well as safety factor
- Signal types
- 5V, 10V, Frequency, USB, RS485
- Digital versus Analog
- Bit resolution

Capacity Selection

- Torque sensor capacity **MUST** accommodate the maximum expected torque for the application
- Overload range is reserved for the occasional accident
- Calculate average running torque -
Torque (LB-IN) = [Horsepower] x [63025]/[RPM]
- Apply appropriate Load and Drive service factors (see Interface Torque Primer)
- Consider startup and inertia loads
- Extraneous loading

Load Factors

- Smooth, constant load devices, fans, centrifugal blowers
- Non-reversing, non-constant load or start/stop devices, extruder's, hoists, conveyors, and mixers
- High variable shock or light reversing loads, crushers, hammer mills, single cylinder reciprocating pumps, vehicle drive lines
- Heavy to full torque reversals, undamped torsional vibrations, single and double acting reciprocating compressors

Starting Conditions

- High inertia load driven by induction motor
- Soft starts and soft stops

Dual Range

- Can seem very attractive but are not a "magic bullet"
- Excellent choice for certain applications
 - Convenience
 - Less fixture changes
- **Compromise**
 - Noise - bandwidth
 - Temperature sensitivity
 - Larger fixtures



**TSQ High Capacity
Square Drive**

300K lbf-in to 3,000K lbf-in
34K Nm to 340K Nm

RPM Considerations

- Observe maximum rpm limit – All sensors have max rating
- Balancing – for high speed operation the entire rotating string must be balanced – **NOT JUST THE SENSOR**
- Limit may be bearings, balancing or g-forces on rotating parts

Interface Torque Transducers

- Bearingless
- Rotary (Dynamic)
- Flange Mount
- Wireless
- Reaction (Static)
- Miniature
- Overload Protected
- Shaft
- Square Drive
- Hex Drive
- Spindle Torque
- USB Output

Interface force measurement torque transducers are available in many design configurations for project designs requiring the highest performance.

To learn more about the Interface products or force measurement solutions call 480-948-5555.

Interface is the world's trusted leader in technology, design and manufacturing of force measurement solutions.

Our clients include a "who's who" of the aerospace, automotive and vehicle, medical device, energy, industrial manufacturing, test and measurement industries.

Interface engineers around the world are empowered to create high-level tools and solutions that deliver consistent, high quality performance. These products include load cells, torque transducers, multi-axis sensors, wireless telemetry, instrumentation and calibration equipment.

Interface, Inc., was founded in 1968 and is a US-based, woman-owned technology manufacturing company headquartered in Scottsdale, Arizona.