

## PEDESTRIAN ENTRANCE CONTROL

### PG300 Paddle Gate

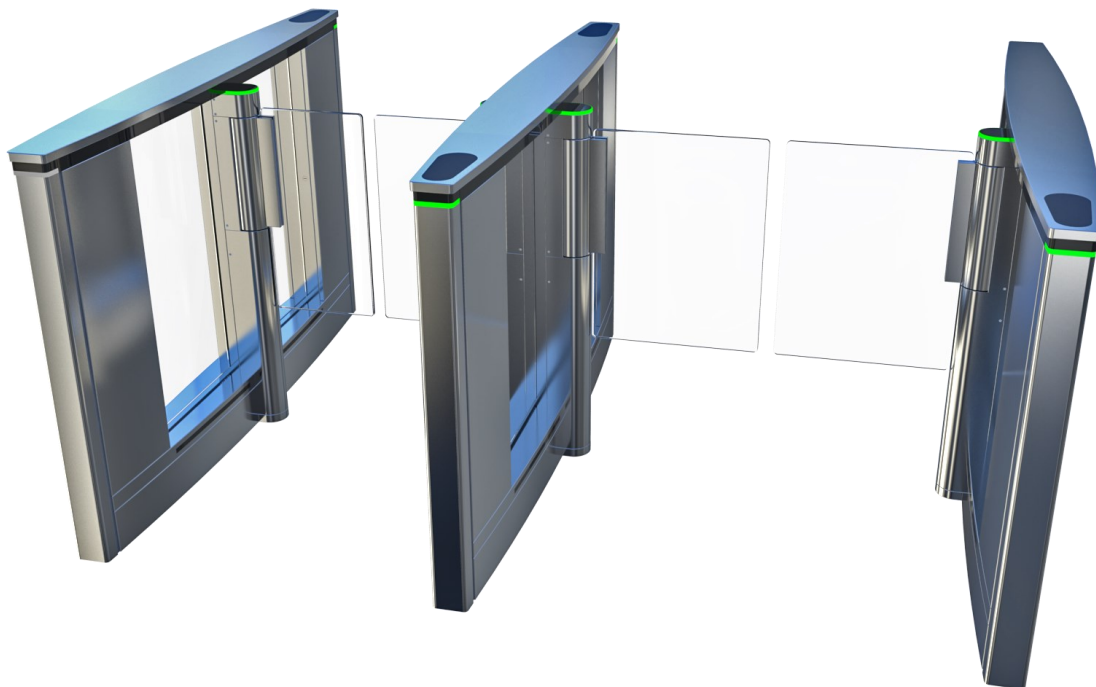

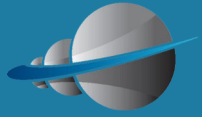

## PG300 PADDLE GATE

The PG300 range of both single and double leafed paddle gates provide safe, high speed, bi-directional pedestrian throughput, with an elegant and sophisticated look, essential for today's corporate environment.

### SECURITY

- 16 detection photocells are used to monitor user progression and security breaches;
- Low gap under obstacle (only 250mm) monitored by low level photocells;
- Various obstacle highs up to 1800mm;
- Standard obstacle material is 10mm thick plexiglass to resist attacks with hammers;
- Electromechanical break to withstand forced entry attempts.

### SAFETY

- 16 Detection photocells provide user protection;
- Low energy impact in the opening and closing cycle;
- Manual push in any direction, in the event of a power loss;
- Fire alarm input to automatically drive the obstacle open in either direction
- Various programable operating modes providing safety over security;
- Wide lane widths up to 1200mm to meets the fire safety standards.

### AESTHETICS

- Transparent glass side walls;
- Minimal footprint;
- Discreet card reader integration;
- Clear plexiglass obstacles;
- Brushed Stainless Steel finished.

### THROUGHPUT

- 25~30 people per/min, depending on access control and users;
- User status pictograms;
- User functional pictograms;
- Stacking function 0-99.



### CONNECTIVITY

- Volt free relay inputs;
- TCP/IP communication;
- Reception touch screen controller;
- Reception push button consoles.

### RELIABILITY

- MCBF of 5 million cycles, with routine maintenance;
- Extended manufactures parts warranty for low cost of ownership.

## KEY FEATURES

1. Aesthetically and streamlined designed with fastest throughput.
2. Easy to Installation, maintain and service.
3. Open protocol: -
  - Onboard diagnostics, no PC required.
  - Free training for anyone wishing to work on its products (subject to T&C) .
  - End users are not tied to one service provider.
4. Security: -
  - Tailgate detection/alarm.
  - Loitering alarm.
  - Wrong direction of travel alarm.
  - Crawling alarm.
  - Obstacles made from 10mm plexiglass as standard.
5. Safety: -
  - 8 send and receive passage detection and safety sensors in the top rail.
  - 8 send and receive enhanced safety detection sensors in the bottom rail.
  - Force limiter.
  - Fire alarm input.
  - Power failure free movement.
6. Standard plexiglass obstacle height 900mm FFL
7. 10mm toughened glass side walls.
8. Standard card reader mounting brackets.
9. Status and functional indicators to advise users whether the lane is in use and whether is safe to pass.



10. Wheelchair / Bulky Item Accessibility - Designed to comply with most international disability regulations such as the UK DDA (Disability Discrimination Act) and the USA ADA (Americans with Disabilities Act) with clear walkway widths up to 1.2m wide.
11. Fire Alarm Integration - Each master cabinet requires a separate normally open contact from the fire alarm panel, when activated the obstacle will automatically drive open.
12. Open Commands – Each controlled direction of travel requires a normally open volt free contact closing for not more than 1 second.
13. Hold Open - Each direction of travel can be held open using the open command. A normally closed volt free contact of more than 3 seconds is required to set the lane into hold open mode.
14. Operating Parameters – there are twelve configurable operating parameters that can adjust the working mode of the lane and its level of security/safety.

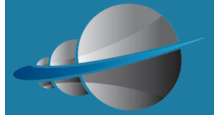

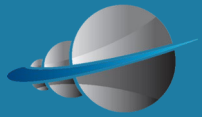

### OBSTACLE HEIGHT

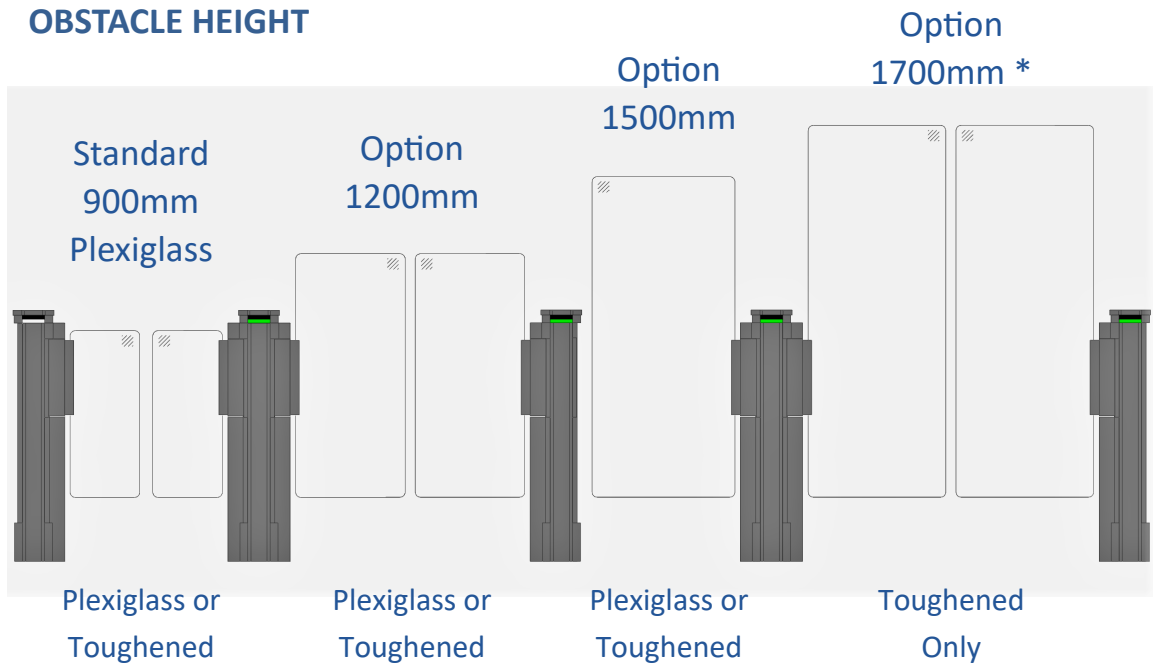

\* On request bespoke obstacle heights from 900mm up to 1800mm.

### OBSTACLE WIDTHS

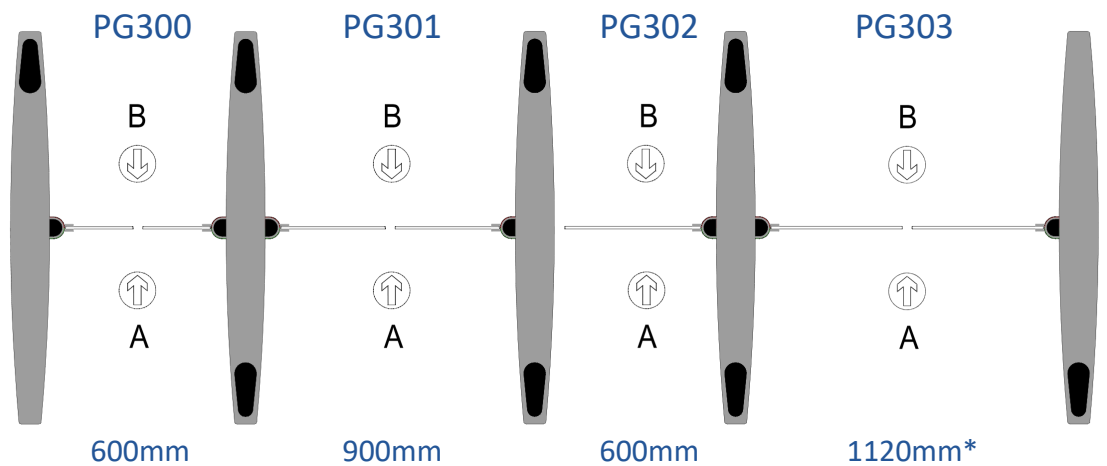

\* On request bespoke obstacle widths from 500mm up to 1200mm.



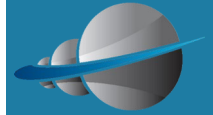

## ORDERING INFORMATION

### Each cabinet is supplied with:-

- Standard Plexi-glass H900.
- Cabinet L1600 x W160 x H980.
- 16 detection sensors.
- 12 months warranty.

PG300 L	W600 Double Leaf Walkway, L/H cabinet (Slave).	<a href="#">Data Sheet</a>
PG300 M	W600 Double Leaf Walkway, Middle cabinet (Master/Slave).	
PG300 R	W600 Double Leaf Walkway, R/H cabinet (Master).	
PG301 L	W900 Double Leaf Walkway, L/H cabinet (Slave).	<a href="#">Data Sheet</a>
PG301 M	W900 Double Leaf Walkway, Middle cabinet (Master/Slave).	
PG301 R	W900 Double Leaf Walkway, R/H cabinet (Master).	
PG302 B	W600 Single Leaf Walkway, L/H cabinet (Slave).	<a href="#">Data Sheet</a>
PG302 MS	W600 Single Leaf Walkway, Middle cabinet (Master/Slave).	
PG302 R	W600 Single Leaf Walkway, R/H cabinet (Master).	
PG303 L	W1120 Double Leaf Walkway, L/H cabinet (Slave).	<a href="#">Data Sheet</a>
PG303 M	W1120 Double Leaf Walkway, Middle cabinet (Master/Slave).	
PG303 R	W1120 Double Leaf Walkway, R/H cabinet (Master).	

## SAFETY IN USE

- For safety reasons, a user smaller than 0.9 m tall must be supervised by an adult at all times when in the vicinity of and during passage through the gate.
- Children MUST precede the accompanying adult when using the gate.
- If regular use by children, elderly and animals is anticipated, Evolve recommends that all options detection sensors are fitted and the parameters set to maximum safety.
- Please refer to the PG300 safety notes.

## EQUIPMENT SPECIFIER

The equipment specifier MUST establish predicted user characteristics and precise operational requirements such as: -

- The volume of pedestrian traffic at different times of the day.
- The type of pedestrian traffic, such as the elderly, the infirm, disabled persons, parents with pushchairs and young children.
- The level of security required.
- Colour/type of clothing such as black, high visibility clothing, etc.

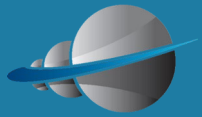

## OPTIONS

### Drillings Templates

Laser cut drilling templates for a speedy and more accurate installation.

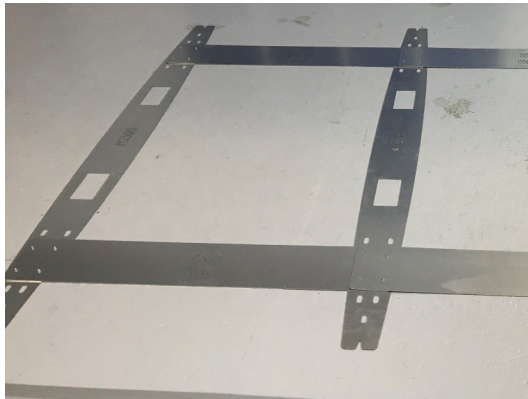

### Surface Plinths

Free standing mounting plinths (floor protector) and walkways are an ideal option to use where you can't fix to the floor, such as listed buildings and under floor heating.

They greatly reduce installation time and costs of civil works as there is no need to dig costly containment channels in the floor for all the cabling.

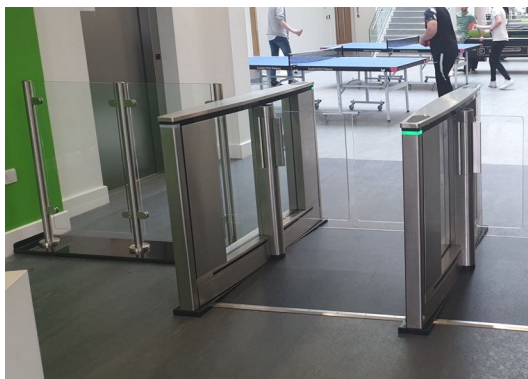

### Glass Plinths

Our free standing glass mounting plinths are an ideal option to use with our cabinet and walkway plinths for sites where you can't fix to the floor.



### Reception Control

Our reception consoles enable members of staff and security guards the facility to allow entry or exit to staff or visitors who don't have the normal access control pass.



### Detection Photocells

Four optional extra photocells provide increase security and safety by enlarging the control zone.

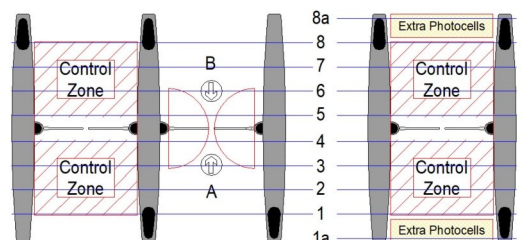



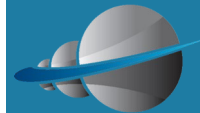

## Output Relays

If required, optional single, double or 4 channel relay modules can be supplied to provide various security alarm outputs.

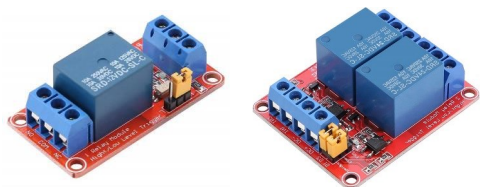

## QR and Barcode Integration

QR and barcode readers are becoming increasingly popular for controlling visitors and contactors.

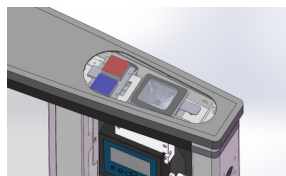

## Remote Fob

Remote fobs can be used to open the gates to allow single passage, to hold the gates open, or to change the work mode.

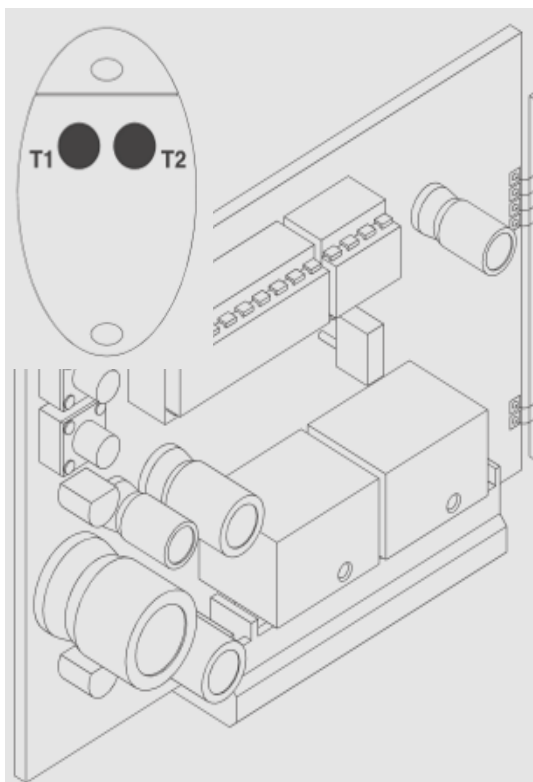

## Face Recognition Integration

Face recognition is becoming increasingly popular for controlling staff, visitors and contactors.

Installing an access control system with face recognition means that you will never have to replace lost or stolen tokens.

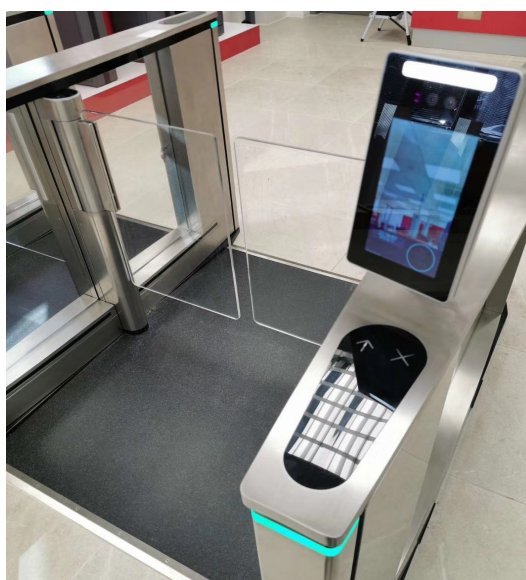

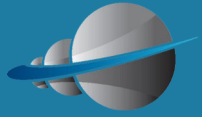

## NPSA

The National Protective Security Authority have identified key security features which may delay the progress of a Marauding Terrorist Attack (MTA).

- Leaves at least 1.8m high above floor level.
- Gaps between the floor and the bottom of the leaves no greater than 220mm.
- Sloping plinths that cannot easily be used as a step to climb over the barriers.
- Fixed panels of a similar height to the leaves fitted to the top of the plinths.
- Laminated glazing or polycarbonate leaves.



## Breakglass

When installed on escape routes and emergency exits than PG300 must be:-

- Connected to the building services fire alarm system, or
- Fitted with a breakglass release button.



## Safety Signage

As a minimum the arms must be fitted with manifestation dots contrasting with the background.

Additional safety can be achieved by fitting other signage in the form of directional and operational indication, and floor signage.

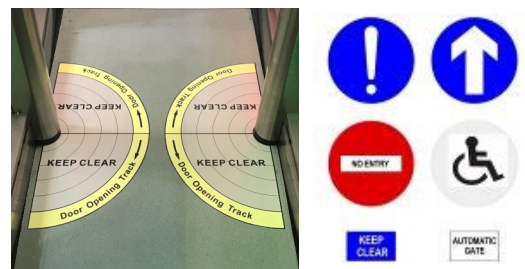



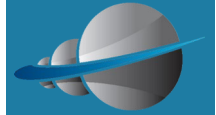

## Glass Balustrade

Glass balustrade can be used to create stylish walkways to control and guide the direction of pedestrian traffic.



## 485 Digital Input/Output Card

The RS485 digital input/output card can be fitted to override the gates normal work mode.

It can be used in conjunction with the key switch, remote fob, desk top console or other normally open contact device.



Photos and information in this brochure are for reference only and may not reflect the actual product. Our brochures and product are subject to change without notice.

# HOW TO CONTACT US



## UK Head Office

### **Evolve Security Products Ltd.**

Unit 4, Kenyons Yard,  
Weyhill Road,  
Andover,  
Hampshire.  
ENGLAND  
SP10 3NP

**t:** 0044 1264 334786

**e:** Sales@EvolveSecurityProducts.com

**w:** EvolveSecurityProducts.com

**w:** Evolvesp.net

## HK Head Office

### **Evolve Autogate Products Ltd.**

Flat C,4/F  
Lladro Center,  
No., 72 Hoi Yuen Road,  
Kwun Tong,  
Kowloon.  
HONG KONG

**t:** 00852 35231568

**e:** info@Evolve-Autogate.com

**w:** Evolve-Autogate.com

**[Click Here For Full List of  
Global Contacts](#)**

**“Evolving the way you manage your pedestrian access.”**