

Datasheet

BIOMETRIC/ IEVO-U - ultimate™ Fingerprint Reader

Product description

The ultimate™ is a CPNI-certified (no data is stored on the reader head) scanner employing a high performance multi-spectral imaging (MSI) sensor. It reads fingerprints from the surface and subsurface levels even if hard to distinguish due to external factors such as dirt, moisture etc. ultimate™ is designed for external use and remains efficient in harsh weather conditions and high foot fall environments.

The reader is capable of AES128-bit encrypted transmission (on request) providing quality & accurate images to be securely transferred to the control board, stored on the secure side of the door. It performs 1:N matching of up to 50,000 fingerprint templates.

ievo



Key features

- Vandal resistant biometric reader
- Up to 50,000 fingerprints via control board
- Optional RFID card reader module
- Customisable RAL colours (at cost)
- Visual and audible feedback

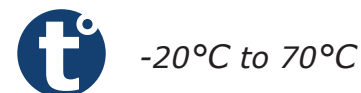

Product Specifications

Housing: PC/ ABS mix

Technology: AES128-bit encryption to control board (on request), Wiegand access control

Sensor: Multispectral Imaging (MSI), Capacitive proximity detection

Mounting: Surface or flush

Users: Up to 50,000 fingerprint templates via control board (10,000 standard)

Image resolution: 500dpi

Interfaces: USB 2.0

Connection: Shielded (S-FTP), Cat5e/6 cable

Communication: RS-422 (1Mbit/s)







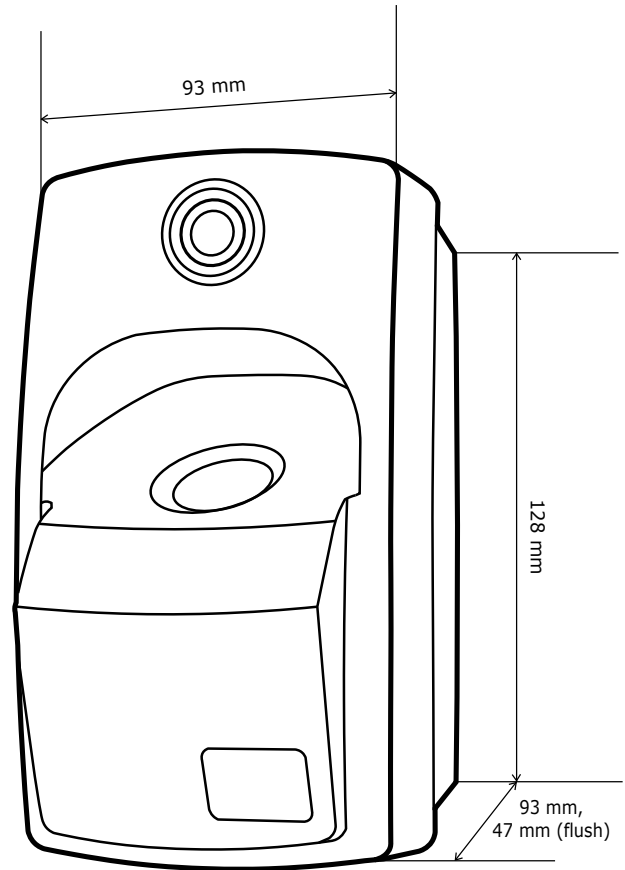

CPU: ARM

Electrical Specifications

Power input: 12V

Current draw: 600mA

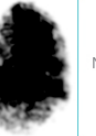

Multispectral Imaging: Fingerprint image quality conditions					
Fingerprint Conditions:	Condition A: Dry	Condition B: Moist	Condition C: Dirty	Condition D: Eldery	Condition E: High levels of ambient light
					
Other Biometric Readers			NO IMAGE		NO IMAGE