

>B< MaxiPro

Air Conditioning and Refrigeration



>B< MaxiPro Technical Brochure
Inch (1/4 - 1 5/8") and Metric (6 - 28 mm)

Join the Press Revolution

Over 115 years of innovation

Conex Bänninger specialises in providing fittings, valves and accessories across the globe by offering innovative and versatile solutions. Since 1909, Conex Bänninger has produced over 22 billion fittings and valves and has built its reputation for quality European manufacturing, backed by first-class customer service and unrivalled expertise.

Passionate about excellence, Conex Bänninger is a byword for quality in the domestic, commercial, industrial, shipbuilding, air conditioning and refrigeration markets worldwide. Conex Bänninger is an ISO 9001 company, which assures their customers of consistency in the quality of their services and products.



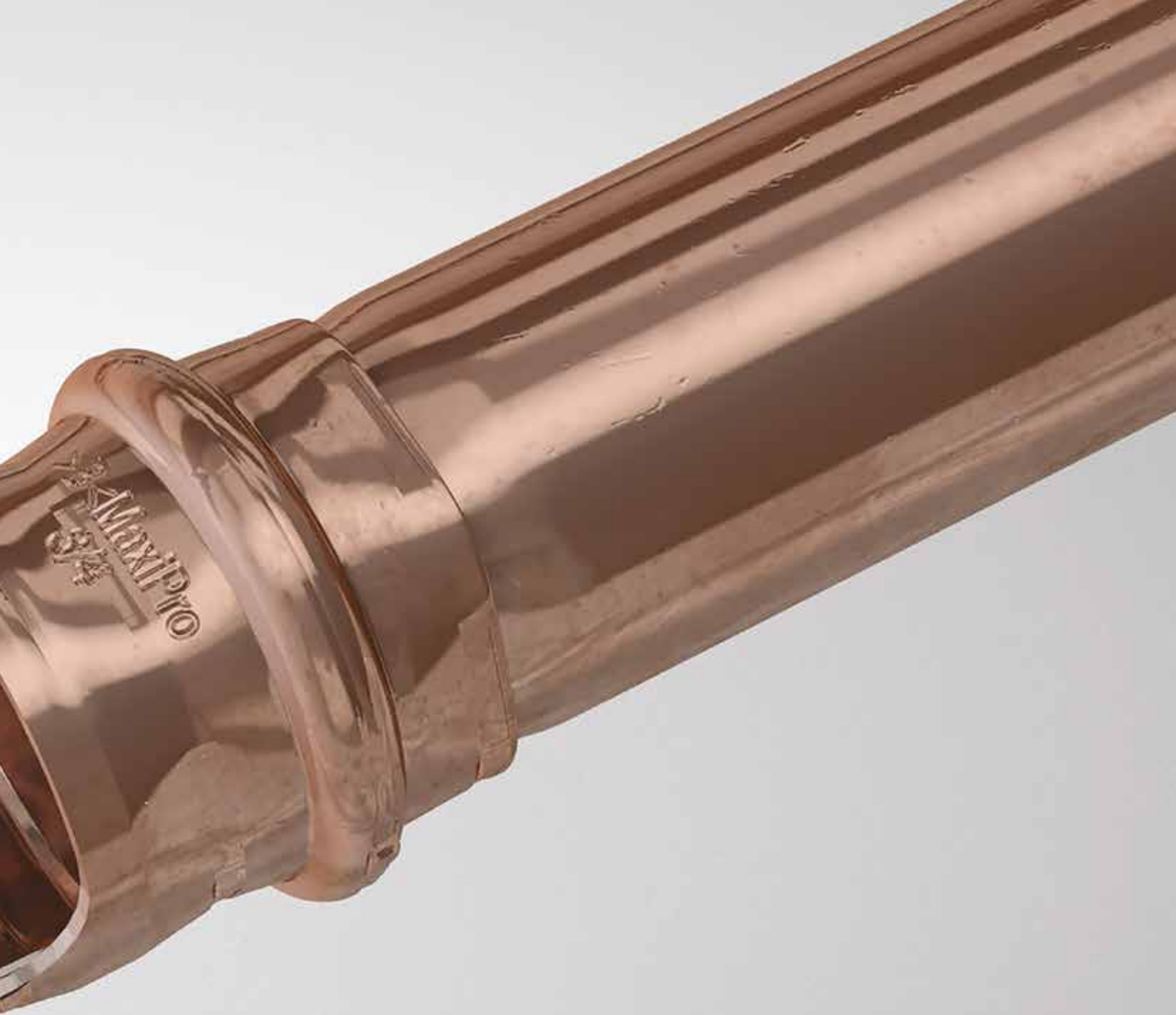

>B< **MaxiPro** is a press fitting system for use with hard, half hard or annealed copper tube conforming to EN 12735-1, EN 12735-2 or ASTM-B280. >B< MaxiPro provides a secure, permanent leak-proof joint suitable for air conditioning and refrigeration applications.



Contents

1	Applications.....	1
2	Features and Benefits	2
3	Technology - 3 Point Press	3
4	Technical Data	4
5	Quality Assurance	4
6	Trademarks and Patents	4
7	Size Availability.....	4
8	Fitting Material	4
9	Approvals, Standards and Test Compliance.....	4
10	Fitting Storage	5
11	Marking and Cleanliness.....	5
12	Thermal Expansion	6
13	Design Considerations	7
	13.1 Pipework support	
	13.2 Pipework protection	
	13.3 Pipework identification and insulation	
	13.4 Earth continuity	
	13.5 Space required for the pressing process	
	13.6 Minimum distance between pressings and insertion depth	
	13.7 Minimum distance for press fittings from an existing brazed joint	
	13.8 Minimum brazing distance to an existing pressed fitting	
	13.9 Testing and commissioning of air conditioning and refrigeration systems	
	13.10 Minimising pressure drop with long radius elbows	
	13.11 >B< MaxiPro tube compatibility tables	
14	>B< MaxiPro Installation Process.....	14
15	Press Tool and Jaw Compatibility	18
	15.1 Press Tool and Jaw Compatibility 19 kN	
	15.2 Press Tool and Jaw Compatibility 32 kN	
16	>B< MaxiPro Product Range - Inch	20
17	>B< MaxiPro Product Range - Metric	28
18	Extended Guarantee	34
19	Abbreviations.....	35
20	Frequently Asked Questions	36

Note: For further updates about >B< MaxiPro please visit www.conexbanninger.com

1. Applications

>B< MaxiPro fittings are designed for the following applications:

- Refrigeration
- Air conditioning
- Heat pump (refrigeration side)
- VRF systems
- Multi split systems



2. Features and Benefits

Flame-free:	Flame-free installation avoids the need for a hot work permit and the risk of fire on site.
No nitrogen purge:	>B< MaxiPro is a mechanical joint, thus eliminating the need for nitrogen purge during the jointing process.
Lower installed cost:	A professional fitting which is quick and simple to install, saving time and money.
Higher productivity, improved flexibility:	Work may be completed during working hours / public access, by a single employee.
Site access:	Easy access to work sites, no gas bottles required.
Quality designed in:	Reliable, repeatable, permanent, tamper-proof connections every time.
3-point press:	Three press points, one each side of the bead, and one press compressing the O-ring. This provides a permanent and secure joint.
High quality O-ring:	A high quality HNBR O-ring forms a secure leak-free joint when pressed.
Protected O-ring:	Lead-in edge design aids tube insertion and helps protect the O-ring from damage or displacement.
Fitting identification:	Fittings are marked >B< MaxiPro and identified with a pink mark indicating their suitability for high pressure air conditioning and refrigeration applications.
Range:	Available in inch sizes ¼" to 1 ½" and metric sizes 6 mm to 28 mm.
Electrical continuity:	Maintains earth continuity without the need for additional earth continuity straps.
Certification:	UL 207 - Edition 9, File #SA44668
Field proven:	Press-fit technology, field proven over 20 years and millions of installed fittings worldwide.
Guarantee:	When professionally installed by a trained and certified >B< MaxiPro installer, >B< MaxiPro fittings are covered by a ten (10) year extended guarantee. Please refer to full terms and conditions, see section 17.
Support:	Backed by Conex Bänninger's experienced technical support and customer services teams.
Compact tooling:	Light compact tooling provides easy access to tightly spaced tube runs.

2.1. >B< Flow Features and Benefits

1. Designed and tested to improve and balance the flow inside the >B< Flow joint, reducing the turbulence and noise
2. A guaranteed equal distribution of refrigerant amongst both legs.
3. Male ends are designed to be fully compatible with >B< MaxiPro providing the perfect assembly.
4. It can accomplish with 3 times safety factor of 48 bar working pressure.
5. >B< Flow comes with pre moulded insulation.



3. Technology 3-Point Press

>B< MaxiPro benefits from a 3-point press - three press points, one on each side of the bead and one press compressing the O-ring. This provides a permanent and secure joint.

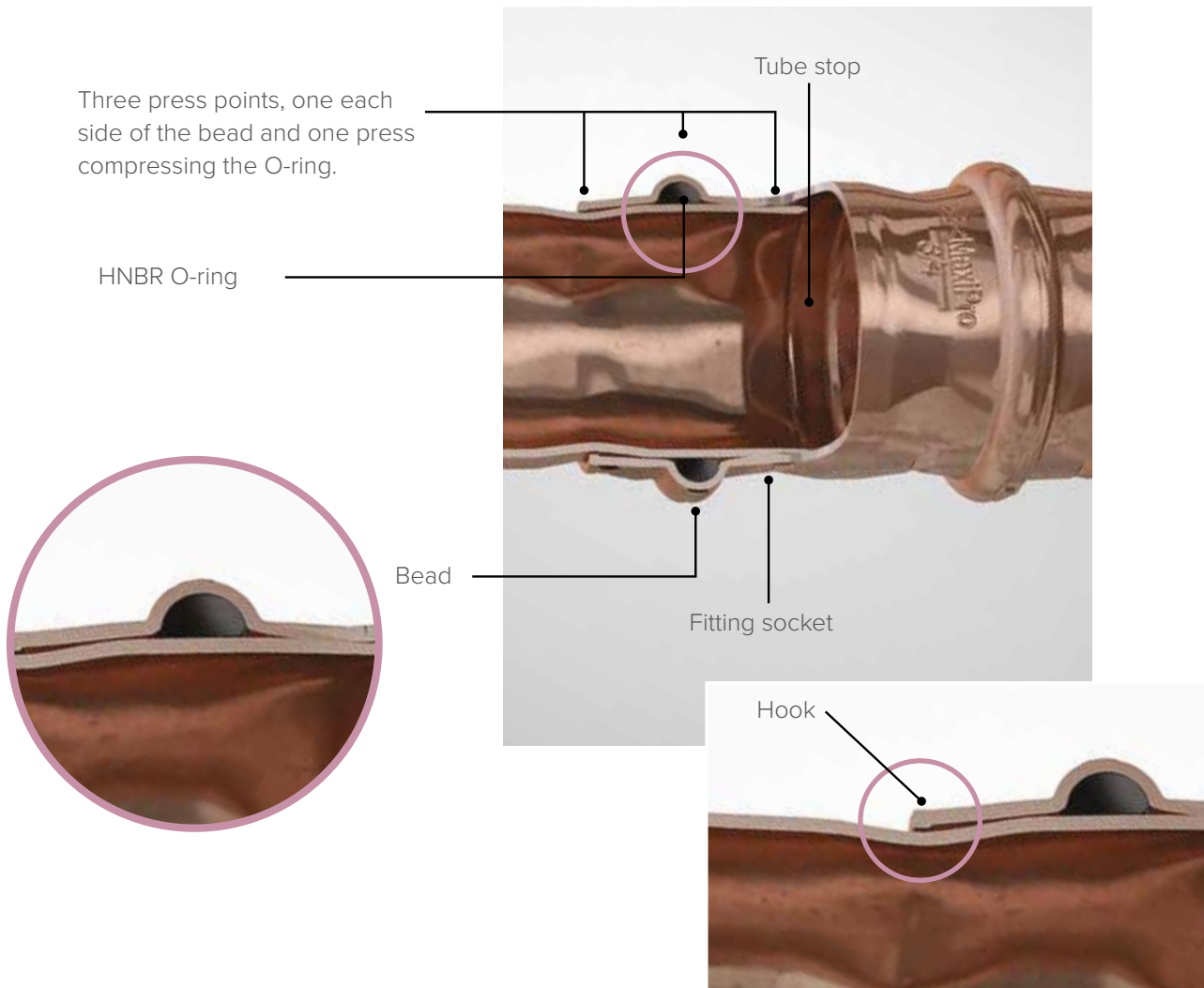

3

On fittings 1/2" and upwards, a hook ensures that the high pressure performance achieved by >B< MaxiPro fittings is maintained.



4. Technical Data

Table 1

Technical Data	
Parameters	Capability
Applications	Air conditioning, refrigeration, heat pump (refrigerant side)
Connections	Copper to copper
Copper tube compatibility*	For latest information on tube compatibility please visit www.conexbanninger.com
Fitting / tube range inch	¼", ⅝", ¾", 1", 1 ¼", 1 ½", 1 ¾", 1 ⅝"
Fitting / tube range metric	6 mm, 8 mm, 10 mm, 12 mm, 15 mm, 16 mm, 18 mm, 22 mm, 28 mm
Fitting material	Refrigerant grade copper (UNS C12200 min 99.9% pure)
O-ring	HNBR
Approved oils	POE, PAO, PVE, AB, MO and PAG
Maximum operating and abnormal pressure	48 bar / 4800 kPa / 700 psig
Burst pressure >3 x maximum operating and abnormal pressure EN 378-2	>144 bar / >14400 kPa / >2100 psi
Leak tightness	Helium ≤ 7.5 × 10 ⁻⁷ Pa.m ³ /s at +20 °C, 10 bar
Vacuum	200 microns
O-ring temperature range	-40 °C to 140 °C / -40 °F to 284 °F
UL listing continuous operating temperature	-40 °C to 121 °C / -40 °F to 250 °F
Compatible refrigerants	R-1234yf**, R-1234ze**, R-125, R-134a, R-290**, R-32**, R-404A, R-407A, R-407C, R-407F, R-407H, R-410A, R-417A, R-421A, R-422B, R-422D, R-424A, R-427A, R-434A, R-437A, R-438A, R-444A**, R-447A**, R-447B**, R-448A, R-449A, R-450A, R-452A, R-452B**, R-452C, R-453A, R-454A**, R-454B**, R-454C**, R455A**, R-456A, R-457A**, R-459A**, R-507A, R-513, R-513A, R-513B, R-515B, R-600A**, R-718, Ethylene Glycol and HYCOOL 20.

*Please refer to >B< MaxiPro - Tube Compatibility Tables, see section 12.10.

** When using refrigerants classified A2L (lower flammability), A2 (flammable) and A3 (higher flammability) additional/specific standards, local rules and regulations, codes of practice and by-laws may be applicable.

Note: >B< MaxiPro fittings are NOT suitable for R-717, R-723, R-764, R-744, R-22 refrigerants.

5. Quality Assurance

Conex Bänninger is an ISO 9001 quality assured company. We are committed to providing quality products and support to our customers.

6. Trademark and Patents

>B< MaxiPro is a registered trademark in numerous territories worldwide. For information on >B< MaxiPro patents visit www.conexbanninger.com

7. Size Availability

>B< MaxiPro is available in inch and metric sizes as follows. Inch ¼", ⅝", ¾", 1", 1 ¼", 1 ½", 1 ¾", 1 ⅝" and 1 ⅝". Metric 6 mm, 8 mm, 10 mm, 12 mm, 15 mm, 16 mm, 18 mm, 22 mm and 28 mm.

8. Fitting Material

>B< MaxiPro is manufactured from refrigerant grade copper (UNS C12200 min 99.9% pure).

9. Approvals, Standards and Test Compliance

- UL 207 - Edition 9, File #SA44668I
- UL 109 - 8 Vibration test, compliant.
- UL 1963 - 79 Tests of gaskets and seals used in refrigerant systems, compliant.
- ISO 5149-2:2014, Refrigerating systems and heat pumps
- Safety and environmental requirements - Part 2: Design, construction, testing, marking and documentation compliant.
- ISO 5149-2, 5.3.2.2.3 Strength pressure test, compliant.
- ISO 14903 - 7.4 Tightness test, compliant.
- ISO 14903 - 7.6 Pressure temperature vibration tests (PTV), compliant.
- ISO 14903 - 7.8 Freezing test, compliant.
- ASTM G85 salt spray (fog) compliant.

12. Thermal Expansion

12.1 Effects of expansion

The coefficient of linear expansion for copper is $16.8 \times 10^{-6} \text{ } ^\circ\text{C}$. For example, a 10 m length of copper tube, irrespective of its size, wall thickness or temper, will increase in length by 10.8 mm a temperature rise of $60 \text{ } ^\circ\text{C}$. Tubes installed on heating services must be free to accommodate this expansion; otherwise stresses will build up in the pipework that may lead to joints being pulled apart and/or tubes fracturing. Clearly the magnitude and frequency of such changes in length will determine the life of the joint or failure of the tube.

Table 2 shows the amount of tube expansion for a given temperature rise. In the case of tube in domestic hot water and heating installations the limited size of rooms and hence straight tube runs, together with the many bends and offsets that normally occur, will result in thermal movement being accommodated automatically. However where long straight tube runs, exceeding 10 m, are encountered, allowance for expansion should be made. A quick, economic and effective way of accommodating thermal expansion is to simply incorporate the horseshoe or compensating bend to the system design.

12.2 Expansion devices

Where copper tubes pass through walls, floors and ceilings, they should be able to move as a result of expansion and contraction. This can be arranged by passing the tube through a sleeve or length of larger diameter tube fixed through the whole thickness of the wall, floor, ceiling, or by means of flexible joints on either side of the wall.

Short stubs to and from internal units, connected to relatively long straight runs should also be avoided. This can usually be achieved by introducing an expansion loop, thereby increasing the length of pipework fixed between the flow/return legs and the radiator connection. However, expansion accommodation techniques such as the use of loops and horseshoes may not be sufficient to accommodate large expansions and in such cases the use of the bellows type couplers may be necessary.

Table 2 shows the increase in length due to thermal expansion as a function of change in temperature Δt and the length of the tube, irrespective of diameter, temper or wall thickness.

Table 2

Tube length m	Change in length mm with temperature difference $\Delta t \text{ } ^\circ\text{C}$							
	$\Delta t=30^\circ$	$\Delta t=40^\circ$	$\Delta t=50^\circ$	$\Delta t=60^\circ$	$\Delta t=70^\circ$	$\Delta t=80^\circ$	$\Delta t=90^\circ$	$\Delta t=100^\circ$
0.1	0.05	0.07	0.08	0.10	0.12	0.13	0.15	0.17
0.2	0.10	0.13	0.17	0.20	0.24	0.27	0.30	0.34
0.3	0.15	0.20	0.25	0.30	0.35	0.40	0.45	0.50
0.4	0.20	0.27	0.34	0.40	0.47	0.54	0.60	0.67
0.5	0.25	0.34	0.42	0.50	0.59	0.67	0.76	0.84
0.6	0.30	0.40	0.50	0.60	0.71	0.81	0.91	1.01
0.7	0.35	0.47	0.59	0.71	0.82	0.94	1.06	1.18
0.8	0.40	0.54	0.67	0.81	0.94	1.08	1.21	1.34
0.9	0.45	0.60	0.76	0.91	1.06	1.21	1.36	1.51
1.0	0.50	0.67	0.84	1.01	1.18	1.34	1.51	1.68
2.0	1.01	1.34	1.68	2.02	2.35	2.69	3.02	3.36
3.0	1.51	2.02	2.52	3.02	3.53	4.03	4.54	5.04
4.0	2.02	2.69	3.36	4.03	4.70	5.40	6.05	6.72
5.0	2.52	3.36	4.20	5.04	5.88	6.72	7.56	8.40
10.0	5.04	6.72	8.40	10.80	11.76	13.44	15.12	16.80
15.0	7.56	10.80	12.60	15.12	17.64	20.16	22.68	25.20
20.0	10.08	13.44	16.80	20.16	23.52	26.88	30.24	33.60
25.0	12.60	16.80	21.00	25.20	29.40	33.60	37.80	42.00

Δt dimensional increase is stated in mm

13. Design Considerations

All refrigeration pipelines must be designed so that the number of joints is kept to a practical minimum. Refrigeration pipelines should be designed in compliance with the following key standards and in line with local regulations, codes of practice and by-laws governing the installation. All applicable health and safety practices must be adhered to.

- EN 378-2:2016 Refrigerating systems and heat pumps. Safety and environmental requirements. Design, construction, testing, marking and documentation.
- ISO 14903:2017 Refrigerating systems and heat pumps - Qualification of tightness of components and joints.
- EN 14276-2:2020. Pressure equipment for refrigerating systems and heat pumps. Piping. General requirements.

13.1 Pipework support

All pipework should be supported by the use of appropriate clips, brackets or supports. Please refer to:

- EN 378-2:2016 Refrigerating systems and heat pumps. Safety and environmental requirements. Design, construction, testing, marking and documentation.

Local regulations, codes of practice and by-laws governing the installation must also be adhered to. Supports should be placed near to fittings when possible and additional supports may be required when using soft copper tubes or where vibration occurs.

13.2 Pipework protection

Tubing and fittings shall be protected as far as possible against adverse environmental or other external effects. Please refer to:

- EN 378-2:2016 Refrigerating systems and heat pumps. Safety and environmental requirements. Design, construction, testing, marking and documentation.

Local regulations, codes of practice and by-laws governing the installation must also be adhered to.

13.3 Pipework identification and insulation

All pipework must be installed in accordance with:

- EN 378-2:2016 Refrigerating systems and heat pumps. Safety and environmental requirements. Design, construction, testing, marking and documentation.

Local regulations, codes of practice and by-laws governing the installation must also be adhered to.

13.4 Earth continuity

>B< MaxiPro fittings maintain earth continuity without the need for additional earth continuity straps.



13.5 Space required for the pressing process

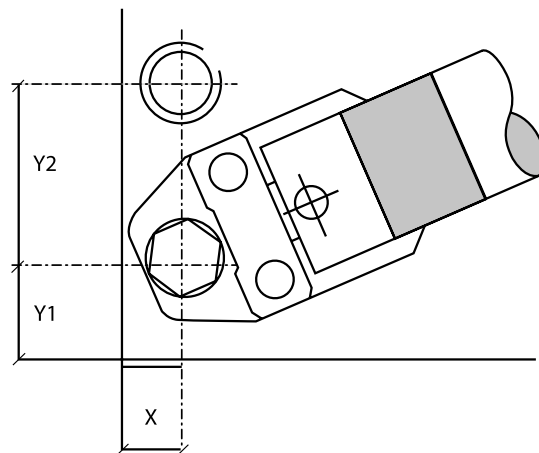
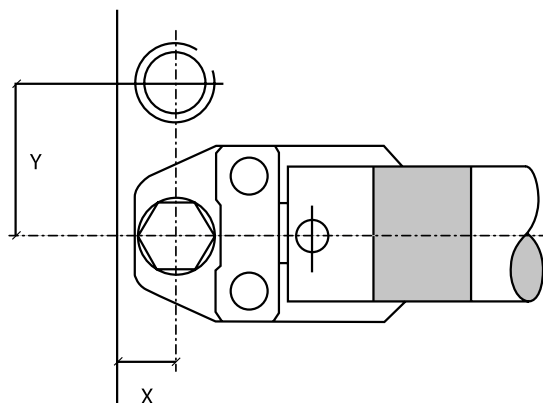

Table 3

Space required for completing a pressing between inch tubes and wall		
Inch tubes - fittings nominal OD	X	Y
Inches	mm	mm
¼"	30	60
⅝"	30	60
¾"	30	60
½"	30	60
⅝"	30	60
¾"	30	60
⅞"	35	60
1"	35	60
1 ⅛"	35	60
1 ⅜"	35	60
1 ½"	65	130

Table 5

Space required for completing a pressing between inch tubes and wall corner			
Inch tubes - fittings nominal OD	X	Y1	Y2
Inches	mm	mm	mm
¼"	50	50	100
⅝"	50	50	100
¾"	50	50	105
½"	50	50	110
⅝"	50	50	110
¾"	50	50	110
⅞"	60	60	120
1"	60	60	120
1 ⅛"	60	60	120
1 ⅜"	60	60	120
1 ½"	100	100	200

Table 4

Space required for completing a pressing between metric tubes and wall		
Metric tubes - fittings nominal OD	X	Y
mm	mm	mm
6	30	60
8	30	60
10	30	60
12	35	60
15	35	60
16	35	60
18	35	60
22	35	60
28	35	60

Table 6

Space required for completing a pressing between metric tubes and wall corner			
Metric tubes - fittings nominal OD	X	Y1	Y2
mm	mm	mm	mm
6	60	60	120
8	60	60	120
10	60	60	120
12	60	60	120
15	60	60	120
16	60	60	120
18	60	60	120
22	60	60	120
28	60	60	120

13.6 Minimum distance between pressings and insertion depth

Due to the reforming of the tube profile when pressed, it is advised that a minimum distance is allowed between each fitting.

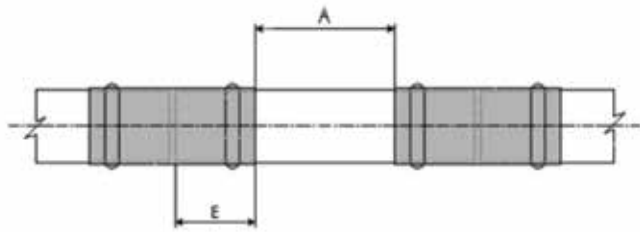

Table 7

Insertion depth and minimum distance between pressings inch tubes		
Inch tubes nominal OD	Minimum distance A	Insertion depth E
Inches	mm	mm
¼"	10	18.0
⅝"	10	19.0
⅜"	10	18.0
½"	15	19.0
⅝"	15	22.0
¾"	20	23.0
⅞"	20	25.0
1"	25	24.0
1 ⅛"	25	26.5
1 ⅜"	35	35.0
1 ½"	35	30

Table 8

Insertion depth and minimum distance between pressings metric tubes		
Metric tubes nominal OD	Minimum distance A	Insertion depth E
mm	mm	mm
6	10	19.0
8	10	19.0
10	10	19.0
12	15	19.0
15	15	22.0
16	20	22.0
18	20	23.0
22	20	23.0
28	25	25.0

13.7 Minimum distance for press fittings from an existing brazed joint

To ensure proper sealing of both the brazed and >B< MaxiPro fittings the following minimum distances must be maintained between the two fittings.

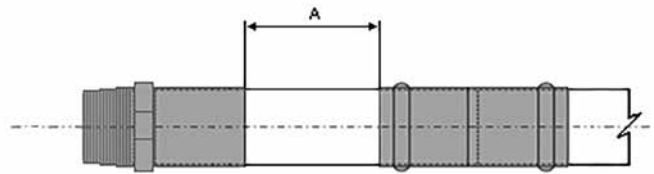

Table 9

Minimum distance from a brazed joint inch tube	
Inch tubes nominal OD	Minimum distance A
Inches	mm
¼"	10
⅝"	10
⅜"	10
½"	15
⅝"	15
¾"	20
⅞"	20
1"	25
1 ⅛"	25
1 ⅜"	35
1 ½"	40

Table 10

Minimum distance from a brazed joint metric tube	
Metric tubes nominal OD	Minimum distance A
mm	mm
6	10
8	10
10	10
12	15
15	15
16	15
18	20
22	20
28	25

Note: It is important that there is no residual brazing or other foreign debris on the tubing to be inserted into the >B< MaxiPro fitting. The surface condition in the area of press joint should be clean and free from debris and comply with EN 12735-1, EN12735-2 and ASTM-B280.

13.8 Minimum brazing distance to an existing pressed fitting

Caution: Brazing near to >B< MaxiPro joints should be avoided as this may cause the seal to degrade due to heat transfer. The table below states the minimum distance away from the press joint from which it is acceptable to braze. If this distance cannot be maintained then adequate precautions must be taken such as fabricating the brazed section prior to assembly with the press fittings, wrapping in a wet rag or applying a heat barrier spray, gel or putty, to prevent heat transfer to the press fitting during brazing.

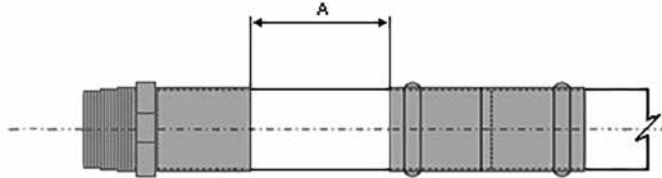

Table 11

Minimum distance brazing to an existing pressed fitting inch tubes	
Inch tubes nominal OD	Minimum distance A
Inches	mm
1/4"	250
5/16"	300
3/8"	300
1/2"	350
5/8"	450
3/4"	500
7/8"	600
1"	650
1 1/8"	700
1 3/8"	900
1 5/8"	1200

Table 12

Minimum distance brazing to an existing pressed fitting metric tubes	
Metric tubes nominal OD	Minimum distance A
mm	mm
6	250
8	300
10	300
12	350
15	450
16	450
18	500
22	600
28	700

13.9 Minimising pressure drop with long radius elbows

Some applications are more sensitive to pressure losses, to minimise pressure drop use long radius elbows.

The table below details the equivalent length of tube for short radius versus long radius elbows, long radius elbows have a shorter equivalent length of tube than short radius elbows, giving a smaller pressure loss.

Table 13

Fitting Size Tube Nominal OD Inches	Elbow Equivalent Lengths of Tube			
	Elbows 90° Brazing Equivalent Length of Tube mm		>B< MaxiPro 90° Elbows Equivalent Length of Tube mm	
	Standard Radius	Long Radius	Standard Radius	Long Radius
1/4"	25.4	17.78	17.78	*
3/8"	30.48	20.32	20.32	*
1/2"	35.56	22.86	30.48	17.78
5/8"	40.64	25.4	33.02	20.32
3/4"	45.72	30.48	38.1	25.4
7/8"	50.8	35.56	43.18	27.94
1 1/8"	66.04	43.18	55.88	35.56
1 3/8"	83.82	58.42	71.12	45.72
1 5/8"	101.6	66.04	N/A	68.58

The ratio of fitting bend to tube dia (R/D) for short radius 90° elbows is approximately 1.0

The ratio of fitting bend to tube dia (R/D) for long radius 90° elbows > 1.5

* 1/4" and 3/8" >B< MaxiPro 90° elbows meet the requirements of long radius elbows as their R/D ratio is > 1.5.

13.10 Testing and commissioning of air conditioning and refrigeration systems

Testing and commissioning of air conditioning and refrigeration systems should be in accordance with the requirements specified in:

- EN 378-2:2016 Refrigerating systems and heat pumps. Safety and environmental requirements. Design, construction, testing, marking and documentation.
- (EU) No 517/2014 on fluorinated greenhouse gases.

Local regulations, codes of practice and by-laws governing the installation must also be adhered to.

General

- Dry oxygen free nitrogen (OFN) should be used for tightness and strength testing as it is inert. Do not use oxygen for pressure testing, under pressure it reacts violently with hydrocarbons (oil and grease) resulting in explosions and fire.
- The maximum test pressure to be identified by the installer. This will be calculated from the system pressure and the test parameters.
- To ensure >B< MaxiPro fittings are tested safely, during the strength pressure and/or tightness test, the pressure should be raised gradually up to the desired test pressure of the system as established by the installer.
- If you are going to leave the pipework pressurized for 24 hours or longer to check for leaks, measure the system pressure and the ambient temperature at the start and finish of the tightness test. A rise in ambient temperature can mask a leak if this is not taken into account. There will be a pressure change of approximately 0.7 bar with a temperature change of 5 °C.
- Care must be taken to ensure a >B< MaxiPro joint will not be close enough to the liquid charging point that the temperature of the joint drops below -40 °C when breaking a vacuum by liquid charging the system.

Problem solving vacuum evacuation

Vacuum evacuation removes air, moisture, and non-condensable gases prior to system charging.

Failure to achieve a vacuum:

- A leak or moisture in the system (see below).
- Vacuum pump not working correctly.
- Vacuum pump does not have sufficient capacity.

Failure to hold a vacuum:

- A leak in the system or the connections to the system
 - find all leaks and repair them.
 - An ultrasonic leak detector can help pinpoint leaks on a system under vacuum.
- Moisture or refrigerant still in the system
 - continue evacuation.
- No remedial action e.g. cutting out fittings from the system should be taken until a proper fault finding exercise has been completed.

13.11 >B< MaxiPro tube compatibility tables

Table 14

>B< MaxiPro Tube Compatibility Table Inch											
>B< MaxiPro fitting size	Tube size Nominal OD		EN 12735-1 / EN 12735-2								
			Nominal wall thickness								
	Inch	mm	0.028" 22swg	0.030"	0.031" 0.032" 21swg	0.035" 0.036" 20swg	0.039" 0.040" 19swg	0.048" 18swg	0.055"	0.064" 0.065" 16swg	0.080 0.094 14swg
Inch	mm	0.71	0.76	0.80 0.81	0.89 0.90 0.91	1.00 1.02	1.22 1.25	1.40	1.63 1.65	2.03 2.41	
¼	0.250"	6.35	● ■	● ■	● ■	● ■	● ■				
⅓	0.312"	7.92			●						
½	0.375"	9.53	● ■		● ■	● ■	● ■				
⅝	0.500"	12.70	● ■		● ■	● ■	● ■	■			
¾	0.625"	15.88			● ■	● ■	● ■	■			
⅞	0.750"	19.05				● ■	● ■	■			
1	0.875"	22.23					● ■	■	■	■	
1 ⅛	1.000"	25.40					■	■		■	
1 ¼	1.125"	28.58					■	■		■	
1 ⅜	1.375"	34.93						■	■	■	
1 ½	1.625"	41.28						■	■	■	■

● Coil lengths in annealed condition

■ Straight lengths in hard /half hard condition

Important:

- Ensure coil tubes are in round condition.
- Hardness tolerance as per approved standards in the table above.
- It is the engineer's responsibility to ensure that the tube selected is compatible with >B< MaxiPro and meets the operating pressure requirements of the system.

Table 15

>B< Max iPro Tube Compatibility Table Metric			
>B< MaxiPro fitting size	Tube size Nominal OD	EN 12735-1 / EN 12735-2	
		Nominal wall thickness	
		1.0 mm	1.5 mm
mm	mm		
6	6	● ■	
8	8	● ■	
10	10	● ■	
12	12	● ■	
15	15	● ■	
16	16	● ■	
18	18	● ■	
22	22	● ■	■
28	28	■	■

● Coil lengths in annealed condition

■ Straight lengths in hard /half hard condition

Notes: Tables 14 and 15:

Hardness tolerance as per approved standards in tables 13 and 14 above.

Ensure coil tubes are in round condition.

It is the engineer's responsibility to ensure that the tube selected is compatible with >B< MaxiPro and meets the operating pressure requirements of the system.

14. >B< MaxiPro Installation Process

General: Conex Bänninger >B< MaxiPro fittings must be installed by an installer who is appropriately trained and qualified to work on air conditioning and refrigeration installations and certified via the >B< MaxiPro training course. All installations must be completed in line with local regulations and by-laws governing the installation, and all applicable health and safety practices must be adhered to.

When using the press tools, care must be taken to ensure hands are kept away from the jaw during the pressing process. Always wear ear and eye protection.

Important: Select the correct size of tube, fitting and jaw for the job. Ensure the fitting and tube are kept free of any dust or dirt and that the O-ring is undamaged. Check the inner pressing contour of the jaw/insert is free of dirt and debris.

Do not force tube ends together prior to making joints. Joints should only be made on an unstressed pipework assembly.

Remarks:

- A joint is finished after one complete compression cycle of the tool.
- Do not press any >B< MaxiPro fitting more than once.
- Pipework alignment must be completed prior to pressing.
- Do not rotate joints after they have been pressed.

Copper tube compatibility: Please refer to tube compatibility table, section 12.10.

Maximum operating pressure: 48 bar, 4800 kPa, 700 psi.

Operating temperature range: -40 °C to 121 °C, -40 °F to 250 °F.

Compatible refrigerants: R-1234yf**, R-1234ze**, R-125, R-134a, R-290**, R-32**, R-404A, R-407A, R-407C, R-407F, R-407H, R-410A, R-417A, R-421A, R-422B, R-422D, R-424A, R-427A, R-434A, R-437A, R-438A, R-444A**, R-447A**, R-447B**, R-448A, R-449A, R-450A, R-452A, R-452B**, R-452C, R-453A, R-454A**, R-454B**, R-454C**, R455A**, R-456A, R-457A**, R-459A**, R-507A, R-513, R-513A, R-513B, R-515B, R-600A**, R-718, Ethylene Glycol and HYCOOL 20.

** When using refrigerants classified A2L (lower flammability), A2 (flammable) and A3 (higher flammability) additional/specific standards, local rules and regulations, codes of practice and by-laws may be applicable.

>B< MaxiPro fittings are NOT suitable for R-717, R-723, R-764, R-744, R-22 refrigerants.

Compatible oils: POE, PAO, PVE, AB and MO.

Jaws:



Standard jaw



Mother jaw



Insert

- For inch fittings compact or standard jaws can be used. 19 kN press tools can press fittings up to 1 1/8" in size, for fittings larger than this a 32 kN press tool and jaw must be used.
- For metric fittings only 19 kN press tools have been approved and can press fittings up to 28 mm. For fittings 6 mm to 28 mm a mother jaw and interchangeable inserts has been approved for use.

For full details on tool and jaw compatibility see section 14.

How to fit or change a press insert in the mother jaw:

If you are using a mother jaw with inserts to press metric fittings please follow the steps outlined below:

- Always remove the jaw from the press tool prior to changing an insert.
- Inserts come in two parts (pairs) and are keyed to slide into the jaw from the side. A spring loaded retaining pin secures the insert in place.
- The keying on the inserts and mother jaw ensures the inserts can only be inserted in the mother jaw in the correct orientation.
- Select the correct size of insert for the fitting you are about to press. Check insert halves are the same size (see step 1).
- Fit the first half of the insert from the side ensuring keying is aligned and the dot lines up with the mouth of the jaw. You will feel a click as the retaining pin secures the insert (see step 2).

- Repeat with the other half of the insert (see step 3).
- To remove the existing insert press the 2 buttons at the mouth of the jaw, one on the front and one on the back, the insert will then drop out (see step 5). To avoid risk of loss ensure the insert drops into your hand or onto a work surface.
- Store the insert you have removed in its carrying case (see step 6).

Fit inserts



1. Check sizes

- Select the correct size of insert for the fitting being pressed.
- Check insert halves are the same size.
- Fit the first half of the insert from the side ensuring keying is aligned and the dot lines up with the mouth of the jaw.



2. Push in insert

- Push the first half of the insert into the mother jaw from the side. Ensure keying is aligned and the dot lines up with the mouth of the jaw.



3. Push in insert

- Repeat with the other half of the insert.
- Always check the insert halves are the same size before pressing any fittings.

Release inserts



4. Mother jaw with insert



5. Press buttons to release insert

- Press the 2 buttons at the mouth of the jaw, one on the front and one on the back, the insert will then drop out. To avoid risk of loss ensure the inserts drop into your hand or onto a work surface.



6. Store in case

- Store the insert you have removed in its carrying case.

Mother jaw and Conex Bänninger >B< MaxiPro inserts maintenance, service and safety:

- Mother jaws and inserts must be cleaned after every use. Keep the internal profile of the mother jaw and insert free of grease or grit.
- Mother jaws must be maintained and serviced in line with manufacturers recommendations.
- Always store the mother jaw and inserts in their case.
- Inserts are a non service item and should be checked periodically for wear and tear, with worn inserts replaced. Inserts should be replaced every 2 years.
- **For your safety, if a mother jaw or insert is damaged they must not be used, replace immediately.**

>B< MaxiPro

Making a joint with a >B< MaxiPro press fitting



1. Cut the tube to length

- Use a rotary tube cutter.
- Ensure that the tube is cut square.
- Check the tube has retained its shape and is damage free.



2. Deburr and remove all external sharp edges

- Deburr the tube both internally and externally.
- Where possible angle the tube downwards to prevent filings entering the tube.
- Use a pencil type deburrer on internal tube edges.
- Make sure the internal and external surfaces of the tube ends are smooth and free from burrs or sharp edges.



3. Use a pencil type deburrer on internal edges



4. Clean the tube end

- Thoroughly clean the tube end using ROTHENBERGER ROVLIES or similar cleaning pad in a rotating action.
- Tube ends must be free from scratches, oxidation, dirt and debris.



5. Check for defects

- If deep scratches are still visible, cut the tube back to a clean section and prepare the tube end again.



6. Ensure the O-ring is seated

- Check the fitting is the correct size for the tube.
- Check the O-rings are present and correctly seated.
- It is good practice to add a small amount of Conex Bänninger press fitting lubricant to the O-rings to aid tube insertion.



7A. Mark insertion depth on tube using depth gauge

- Insert tube into correct socket in depth gauge.
- Check window to see the tube is fully inserted.
- Mark the insertion depth on the tube.



7B. Alternatively insert tube to tube stop and mark

- The tube must be fully inserted into the fitting until it reaches the tube stop.
- To reduce the risk of dislodging the O-ring rotate the tube (if possible) while slipping it into the fitting.
- Mark the insertion depth on the tube.



7B. Check the depth mark

- Remove the tube and align with fitting socket, check that the depth mark is correctly positioned.
- The insertion depth mark is used as a reference prior to pressing the joint.



8. Insert the tube fully into the fitting. Ensure tube is fully inserted prior to pressing

- Insert the tube fully into the fitting up to the tube stop.
- To reduce the risk of dislodging the O-ring rotate the tube (if possible) while slipping it into the fitting.
- Prior to pressing, ensure the tube has not moved out from the fitting socket.
- Use the insertion depth mark as a guide.

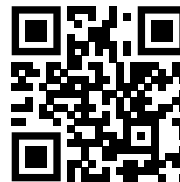

Use the QR code app on your smart phone or tablet to access www.conexbanninger.com

1/4" to 1 1/2"



1. Align jaws squarely on the fitting

- Ensure pipework is correctly aligned prior to pressing.
- Ensure the correct size jaw is inserted into the tool.
- The jaws must be placed squarely on the fitting locating the groove on the bead.
- The bead on the fitting should fit centrally in the groove of the jaw.



2. Complete the joint with the approved tool. Press once only

- Depress and hold the button to complete the pressing cycle.
- Pressing is complete when the jaws are fully closed and the piston retracts.
- Complete the press cycle once only – do not repress.
- Release the jaws from the pressing.



3. Mark the completed joint

- Mark the completed joint after pressing.
- This enables joints to be inspected easily before testing and insulating the pipework.

1 3/8" / 1 5/8"



1. Fit the pressing ring

- Using the appropriate size pressing ring, open, and locate onto the fitting bead.
- Close the pressing ring fully



2. Engage adaptor

- With the adaptor jaw fitted in the press tool, open the actuator and locate it into the aperture of the pressing ring.
- Check for any tube movement prior to pressing



3. Complete the joint with the press tool

- Press and hold the trigger/ button on the press tool to begin the pressing cycle.
- The tool automatically stops when the cycle has been completed.

IMPORTANT: The joint is complete after one full cycle. DO NOT crimp any fitting more than once.

Installing a >B< MaxiPro female flare connector to a male flare connector.

Make the flare connection prior to pressing the >B< MaxiPro joint. If this is not possible care must be taken to prevent rotational forces being applied to the pressed joint.

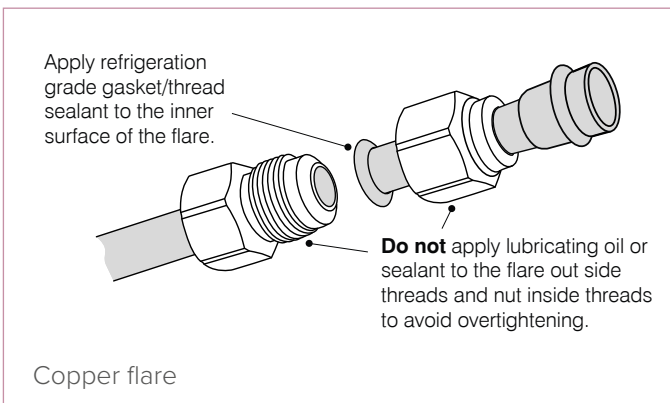

Align the centers of both flares and tighten the flares by hand.

***Note:** A high viscosity refrigerant grade oil may be used if sealant is not available.

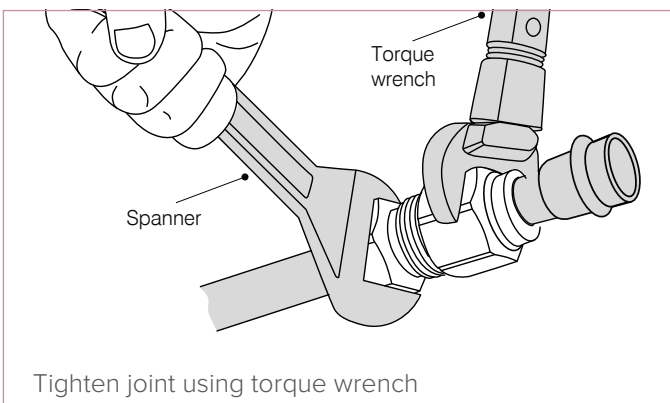

Fully tighten using spanner and torque wrench to the torque values set out in table 16. **Do not over tighten.**

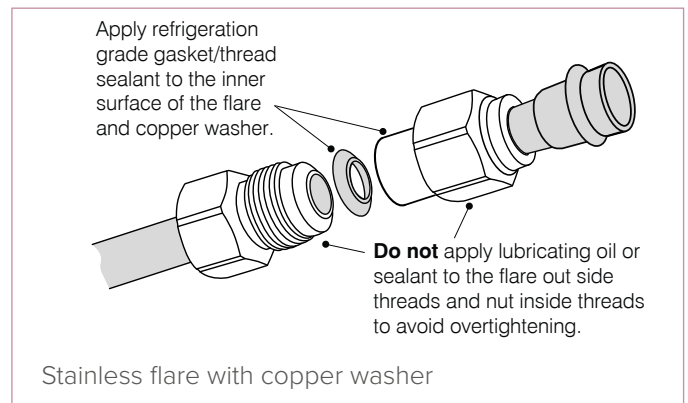

Align the centers of both flares and tighten the flares by hand.

***Note:** A high viscosity refrigerant grade oil may be used if sealant is not available.

Table 16

Flares Tightening Torque		
Size	Nm	ft lbf
1/4"	14-18	11-13
3/8"	33-42	25-31
1/2"	50-62	37-45
5/8"	63-77	47-56
3/4"	90-110	67-81
Do not over tighten		

15. Press Tool and Jaw Compatibility

15.1 Press Tool and Jaw Compatibility 19 kN

For inch fittings recommended and other compatible 19 kN press tools can be used with approved >B< MaxiPro jaws to press fittings up to 1 1/8". For fittings larger than 1 1/8" a 32 kN press tool must be used.

For metric fittings recommended and other compatible 19 kN press tools can be used with approved mother jaw and Conex Bänninger Inserts to press fittings up to 28 mm.

All tools and jaws used must be maintained and serviced in line with manufacturers recommendations.

The tables below list the; press tools, jaws, mother jaws and inserts that may be used with >B< MaxiPro fittings. Use of non listed; press tools, jaws, mother jaws and inserts may void your guarantee.

Press Tool and Jaw Compatibility: 19/22 kN - Inch

Approved >B< MaxiPro 19 kN press tool and jaw - Inch							
Press Tool Manufacturer	Tool	ROTHENBERGER		Novopress	REMS	Roller	Milwaukee
		Jaw: >B< MaxiPro	Press Ring: >B< MaxiPro (CBMP)*	Jaw: BMP	Jaw: BMP	Jaw: BMP	Jaw: BMP
Conel	PM1	✓	✓	✓			✓
HILTI	NPR 19-A	✓	✓	✓			✓
Klauke	MAP219	✓	✓	✓			✓
ROTHENBERGER	ROMAX® Compact TT (EU)	✓	✓	✓			✓
	ROMAX® Compact	✓	✓	✓			✓
	ROMAX® Compact 3	✓	✓	✓			✓
Novopress	ACO102	✓	✓	✓			✓
	ACO103	✓	✓	✓			✓
REMS (22 kN)	Mini Press ACC				✓	✓	
Ridgid	RP 219	✓	✓	✓			✓
Roller (22 kN)	Multi-Press Mini ACC				✓	✓	
Milwaukee	M12HPT	✓	✓	✓			✓

19 kN press tools are capable of pressing fittings/tube up to 1 1/8" for fittings/tube greater than 1 1/8" a 32 kN press tool is required.

All tools and jaws used must be maintained and serviced in line with manufacturers recommendations.

Use of non listed press tools or jaws may void your guarantee.

*Pressed with compact ZBR adaptor.

Press Tool, Jaw and Insert Compatibility: 19 kN - Metric

Approved >B< MaxiPro 19 kN press tool, jaw & insert - Metric			
Press Tool Manufacturer	Tool	Jaw & Insert Manufacturer	
		Novopress / Conex Bänninger	Jaw & Insert: >B< MaxiPro
Conel	PM1		✓
HILTI	NPR 19-A		✓
Klauke	MAP219		✓
ROTHENBERGER	ROMAX® Compact TT (Europe)		✓
	ROMAX® Compact		✓
	ROMAX® Compact 3		✓
Novopress	ACO102		✓
	ACO103		✓
Ridgid	RP 219		✓
Milwaukee	M12HPT		✓

19 kN press tools are capable of pressing fittings/tube up to 28 mm for fittings/tube greater than 28 mm a 32 kN press tool is required.

Only Conex Bänninger Inserts are approved for use with >B< MaxiPro.

All tools and jaws used must be maintained and serviced in line with manufacturers recommendations.

Use of non listed press tools or jaws may void your guarantee.

Press Tool and Jaw Compatibility: 24 kN - Inch

Approved >B< MaxiPro 24 kN press tool and jaw - Inch				
Press Tool Manufacturer	Tool	Jaw Manufacturer		
		ROTHENBERGER	Novopress	REMS
		Jaw: >B< MaxiPro	Jaw: BMP	Jaw: BMP
Milwaukee	M12	✓	✓	✓
Ridgid	RP 200-B	✓	✓	✓
	RP 210-B	✓	✓	✓
	RP 240	✓	✓	✓
	RP 241	✓	✓	✓
	RP251	✓	✓	✓
ROTHENBERGER	ROMAX TT US	✓	✓	✓
Rems	Mini Press A4	✓	✓	✓

24 kN press tools are capable of pressing fittings/tube up to 1 1/8" for fittings/tube greater than 1 1/8" a 32 kN press tool is required.

All tools and jaws used must be maintained and serviced in line with manufacturers recommendations.

Use of non listed press tools or jaws may void your guarantee.

15.2 Press Tool and Jaw Compatibility 32 kN

Conex Bänninger recommends the use of 32 kN press tools in combination with >B< MaxiPro jaws.

All tools and jaws used must be maintained and serviced in line with manufacturers recommendations.

Press Tool and Jaw Compatibility: 32 kN - Inch & Metric (Mother Jaw and Insert >B< MaxiPro)

Approved >B< MaxiPro 32 kN press tool and jaw - Inch								
Press Tool Manufacturer	Tool	Jaw Manufacturer						
		ROTHENBERGER		Novopress	REMS	Roller	Milwaukee	Virax
		Jaw (inch): >B< MaxiPro	Press Ring: >B< MaxiPro*	Jaw (inch) BMP	Jaw: BMP	Jaw: BMP	Jaw: BMP	Jaw: >B< MaxiPro
Conel	PM2	✓	✓	✓	✓	✓	✓	✓
Hilti	NPR 032 IE-A22	✓	✓	✓	✓	✓	✓	✓
Klauke	UAP2/3/4	✓	✓	✓	✓	✓	✓	✓
	UAP332	✓	✓	✓	✓	✓	✓	✓
	UAP432	✓	✓	✓	✓	✓	✓	✓
Milwaukee	M18 BLHPT	✓	✓	✓	✓	✓	✓	✓
	M18 BLHPT-XL	✓	✓	✓	✓	✓	✓	✓
Nibco	PC-100	✓	✓	✓	✓	✓	✓	✓
	PC-280	✓	✓	✓	✓	✓	✓	✓
Novopress	ACO202XL	✓	✓	✓	✓	✓	✓	✓
	ACO202	✓	✓	✓	✓	✓	✓	✓
	ACO203XL	✓	✓	✓	✓	✓	✓	✓
	ACO203	✓	✓	✓	✓	✓	✓	✓
REMS	Akku-Press	✓	✓	✓	✓	✓	✓	✓
	Power-Press	✓	✓	✓	✓	✓	✓	✓
Ridgid	RP 320	✓	✓	✓	✓	✓	✓	✓
	RP 330/B/C	✓	✓	✓	✓	✓	✓	✓
	RP 340	✓	✓	✓	✓	✓	✓	✓
	RP 350	✓	✓	✓	✓	✓	✓	✓
	RP351	✓	✓	✓	✓	✓	✓	✓
	RP352-XL	✓	✓	✓	✓	✓	✓	✓
ROTHENBERGER	ROMAX 3000	✓	✓	✓	✓	✓	✓	✓
	ROMAX 4000	✓	✓	✓	✓	✓	✓	✓
	ROMAX NANO	✓	✓	✓	✓	✓	✓	✓
Uponor	UP110	✓	✓	✓	✓	✓	✓	✓
Virax	Viper P25+	✓	✓	✓	✓	✓	✓	✓
	Viper P30+	✓	✓	✓	✓	✓	✓	✓
Roller	Multi-Press	✓	✓	✓	✓	✓	✓	✓
	Uni-Press	✓	✓	✓	✓	✓	✓	✓
Viega	Pressgun 5/6	✓	✓	✓	✓	✓	✓	✓

*All 32kN tools listed can be used with the new 32kN mother jaw in the metric range.

Press Tool, Jaw and Sling Compatibility: 1 3/8" 32 kN - Inch

1 3/8" 32 kN Machines			
Press Tool Manufacturer	Tool	Jaw Manufacturer	Jaw & Adaptor
Milwaukee	M18 BLHPT	Milwaukee	1 3/8" Sling + Ring Jaw 1 Adaptor
	M18 BLHPT-XL		
Novopress	ACO203	Novopress	1 3/8" Sling + ZB203 Adaptor
	ACO203XL		
ROTHENBERGER	ROMAX 3000	ROTHENBERGER	1 3/8" Sling + ZBS1 Adaptor
	ROMAX 4000		
	ROMAX NANO		

Press Tool, Jaw and Sling Compatibility: 1 5/8"

1 5/8" Machines			
Press Tool Manufacturer	Tool	Jaw Manufacturer	Jaw & Adaptor
Milwaukee	M18 BLHPT-XL	Milwaukee	1 5/8" Sling + Ring Jaw 1 Adaptor RJAXL-1
Novopress	ACO203XL	Novopress	1 5/8" Sling + Ring Jaw 1 Adaptor ZB221
Ridgid	RP352-XL	Novopress	
REMS	Akku-Press	REMS	
	Power - Press		
	REMS Akku-Press XL 45 kN 22 V ACC		

* For further tool and jaw compatibility please contact the technical team.

>B< MaxiPro

16. >B< MaxiPro Product Range - Inch

MPA5001 90° Street Bend

NOW INCLUDING
5/16"

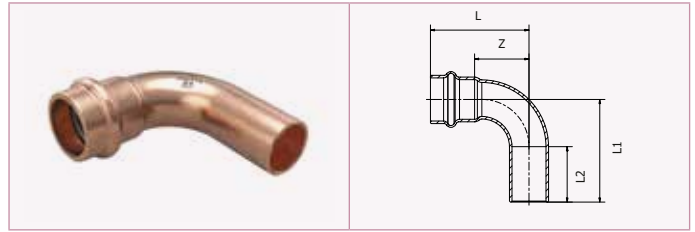

Code	Size	L	L1	L2	Z
MPA5001 5160001	5/16"	33.0	36.0	21.0	15.0
MPA5001 0030001	3/8"	33.0	34.5	21.0	15.0
MPA5001 0040001	1/2"	31.5	34.5	20.5	14.0
MPA5001 0050001	5/8"	39.0	45.0	24.0	18.0
MPA5001 0060001	3/4"	42.5	48.0	25.0	20.5
MPA5001 0070001	7/8"	50.0	53.0	27.0	26.0
MPA5001 0080001	1"	54.0	56.0	26.5	31.0
MPA5001 0090001	1 1/8"	57.0	61.5	28.5	31.5
MPA5001 0110001	1 3/8"	69.0	82.0	37.0	35.0

MPA5002 90° Bend

NOW INCLUDING
5/16"

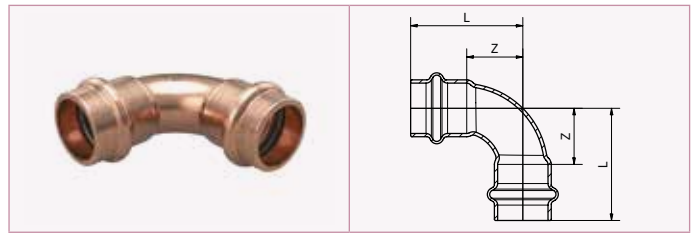

Code	Size	L	Z
MPA5002 0020001	1/4"	32.5	14.5
MPA5002 5160001	5/16"	33.0	15.0
MPA5002 0030001	3/8"	33.0	15.0
MPA5002 0040001	1/2"	31.5	14.0
MPA5002 0050001	5/8"	39.0	18.0
MPA5002 0060001	3/4"	42.5	20.5
MPA5002 0070001	7/8"	50.0	26.0
MPA5002 0080001	1"	53.0	29.5
MPA5002 0090001	1 1/8"	57.0	31.5
MPA5002 0110001	1 3/8"	69.0	35.0

MPA5002L 90° Bend

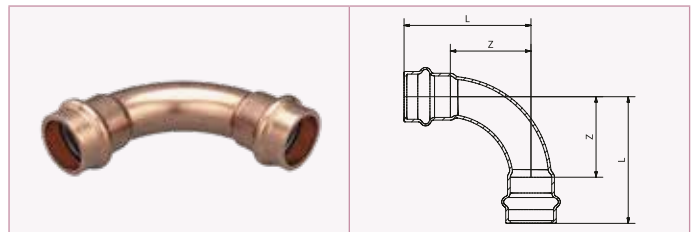

Code	Size	L	Z
MPA5002L0040001	1/2"	43.5	26.0
MPA5002L0050001	5/8"	50.0	29.0
MPA5002L0060001	3/4"	56.0	34.0
MPA5002L0070001	7/8"	66.0	42.0
MPA5002L0090001	1 1/8"	77.0	51.5
MPA5002L0110001	1 3/8"	89.0	54.7
MPA5002L0130001	1 5/8"	144.0	79.0

Note: All above measurements are in mm unless stated differently.

>B< MaxiPro Product Range - Inch

NOW INCLUDING 5/16"

MPA5041 45° Obtuse Elbow

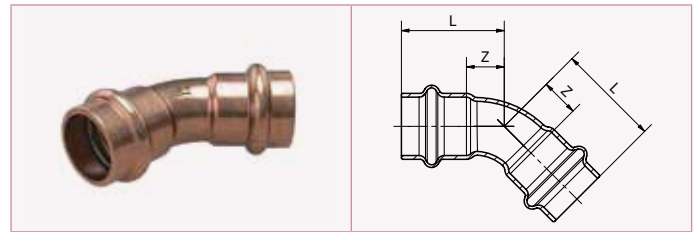

Code	Size	L	Z
MPA5041 0020001	1/4"	23.5	5.5
MPA5041 5160001	5/16"	24.0	6.0
MPA5041 0030001	3/8"	26.0	8.0
MPA5041 0040001	1/2"	24.0	6.5
MPA5041 0050001	5/8"	28.0	7.0
MPA5041 0060001	3/4"	31.5	9.5
MPA5041 0070001	7/8"	34.0	10.0
MPA5041 0080001	1"	35.5	12.0
MPA5041 0090001	1 1/8"	39.5	14.0
MPA5041 0110001	1 3/8"	52.0	18.0
MPA5041 0130001	1 5/8"	62	31

NOW INCLUDING 5/16"

MPA5240 Reducing Coupler

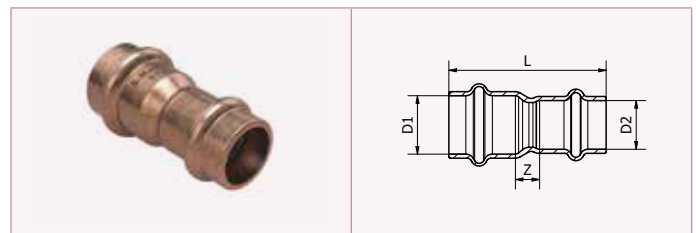

Code	Size	L	Z	D1	D2
MPA5240 0030201	3/8" x 1/4"	42.0	6.0	3/8"	1/4"
MPA5240 0035161	3/8" x 5/16"	44.0	5.0	3/8"	5/16"
MPA5240 0040201	1/2" x 1/4"	44.0	8.5	1/2"	1/4"
MPA5240 0040301	1/2" x 3/8"	42.5	7.0	1/2"	3/8"
MPA5240 0050201	5/8" x 1/4"	52.0	13.0	5/8"	1/4"
MPA5240 0050301	5/8" x 3/8"	47.5	8.5	5/8"	3/8"
MPA5240 0050401	5/8" x 1/2"	45.5	7.0	5/8"	1/2"
MPA5240 0060301	3/4" x 3/8"	51.0	11.0	3/4"	3/8"
MPA5240 0060401	3/4" x 1/2"	46.0	6.5	3/4"	1/2"
MPA5240 0060501	3/4" x 5/8"	52.5	9.5	3/4"	5/8"
MPA5240 0070401	7/8" x 1/2"	52.5	11.0	7/8"	1/2"
MPA5240 0070501	7/8" x 5/8"	52.5	7.5	7/8"	5/8"
MPA5240 0070601	7/8" x 3/4"	52.5	6.5	7/8"	3/4"
MPA5240 0080601	1" x 3/4"	55.0	9.5	1"	3/4"
MPA5240 0090501	1 1/8" x 5/8"	55.0	8.5	1 1/8"	5/8"
MPA5240 0090601	1 1/8" x 3/4"	57.5	10.0	1 1/8"	3/4"
MPA5240 0090701	1 1/8" x 7/8"	58.0	8.5	1 1/8"	7/8"
MPA5240 0090801	1 1/8" x 1"	56.0	7.0	1 1/8"	1"
MPA5240 0110701	1 3/8" x 7/8"	67.0	13.0	1 3/8"	7/8"
MPA5240 0110801	1 3/8" x 1"	72.0	15.0	1 3/8"	1"
MPA5240 0110901	1 3/8" x 1 1/8"	72.0	12.5	1 3/8"	1 1/8"
MPA5240 0130901	1 5/8" x 1 1/8"	73.5	18	1 5/8"	1 1/8"
MPA5240 0131101	1 5/8" x 1 3/8"	75.5	11.2	1 5/8"	1 3/8"

Note: All above measurements are in mm unless stated differently.

>B< MaxiPro

>B< MaxiPro Product Range - Inch

MPA5240L Long Reducing Coupler

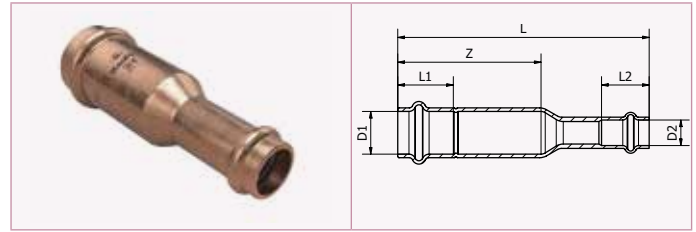

Code	Size	D1	D2	L	L1	L2	Z
MPA5240L0030201	3/8" x 1/4"	3/8"	1/4"	94.5	18.0	18.0	58.0
MPA5240L0050301	5/8" x 3/8"	5/8"	3/8"	95.0	21.0	18.0	55.5
MPA5240L0050401	5/8" x 1/2"	5/8"	1/2"	95.0	21.0	17.5	55.5
MPA5240L0080501	1" x 5/8"	1"	5/8"	100.0	23.5	21.0	53.0

**NOW INCLUDING
5/16"**

MPA5243 Fitting Reducer

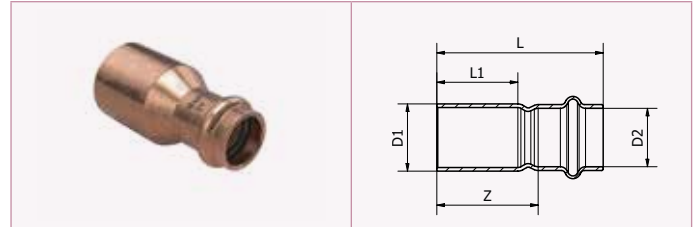

Code	Size	L	L1	Z	D1	D2
MPA5243 5160201	5/16" x 1/4"	44.5	21.0	25.5	5/16"	1/4"
MPA5243 0055161	5/8" x 5/16"	52.0	24.0	33.0	5/8"	5/16"
MPA5243 0030201	3/8" x 1/4"	44.0	21.0	26.0	3/8"	1/4"
MPA5243 0040301	1/2" x 3/8"	45.0	20.5	27.0	1/2"	3/8"
MPA5243 0050301	5/8" x 3/8"	47.5	24.0	29.5	5/8"	3/8"
MPA5243 0050401	5/8" x 1/2"	46.0	24.0	28.5	5/8"	1/2"
MPA5243 0060401	3/4" x 1/2"	53.0	25.0	35.5	3/4"	1/2"
MPA5243 0060501	3/4" x 5/8"	53.5	25.0	32.5	3/4"	5/8"
MPA5243 0070401	7/8" x 1/2"	54.0	27.0	36.5	7/8"	1/2"
MPA5243 0070501	7/8" x 5/8"	54.5	27.0	33.5	7/8"	5/8"
MPA5243 0070601	7/8" x 3/4"	53.0	27.0	31.0	7/8"	3/4"
MPA5243 0090401	1 1/8" x 1/2"	61.0	28.5	43.5	1 1/8"	1/2"
MPA5243 0090501	1 1/8" x 5/8"	63.5	28.5	42.5	1 1/8"	5/8"
MPA5243 0090601	1 1/8" x 3/4"	60.0	28.5	38.0	1 1/8"	3/4"
MPA5243 0090 701	1 1/8" x 7/8"	59.5	28.5	35.5	1 1/8"	7/8"
MPA5243 0110701	1 3/8" x 7/8"	74.5	37.5	50.5	1 3/8"	7/8"
MPA5243 0110801	1 3/8" x 1"	72.5	37.5	49.0	1 3/8"	1"
MPA5243 0110901	1 3/8" x 1 1/8"	74.5	37.5	49.0	1 3/8"	1 1/8"
MPA5243 0130901	1 5/8" x 1 1/8"	75.5	33	41.5	1 5/8"	1 1/8"
MPA5243 0131101	1 5/8" x 1 3/8"	77	33	39	1 5/8"	1 3/8"

Note: All above measurements are in mm unless stated differently.

>B< MaxiPro Product Range - Inch

NOW INCLUDING 5/16"



MPA5270 Straight Coupler

Code	Size	L	Z
MPA5270 0020001	1/4"	39.0	3.0
MPA5270 5160001	5/16"	39.0	3.0
MPA5270 0030001	3/8"	38.0	3.0
MPA5270 0040001	1/2"	40.0	5.0
MPA5270 0050001	5/8"	45.0	3.0
MPA5270 0060001	3/4"	45.5	1.5
MPA5270 0070001	7/8"	56.5	8.5
MPA5270 0080001	1"	49.0	2.0
MPA5270 0090001	1 1/8"	57.0	6.0
MPA5270 0110001	1 3/8"	71.0	3.0
MPA5270 0130001	1 5/8"	66	5

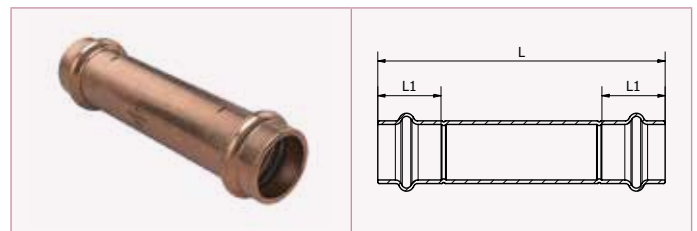

MPA5270L Long Coupler

Code	Size	L	L1
MPA5270L0020001	1/4"	90.0	18.0
MPA5270L0030001	3/8"	90.0	18.0
MPA5270L0040001	1/2"	91.0	17.5
MPA5270L0050001	5/8"	101.0	21.0
MPA5270L0060001	3/4"	101.0	22.0
MPA5270L0070001	7/8"	106.0	24.0
MPA5270L0080001	1"	105.0	23.5
MPA5270L0090001	1 1/8"	106.0	25.5
MPA5270L0110001	1 3/8"	100	34
MPA5270L0130001	1 5/8"	104	30

Note: All above measurements are in mm unless stated differently.

>B< MaxiPro

>B< MaxiPro Product Range - Inch

MPA5275L Long Repair Coupler

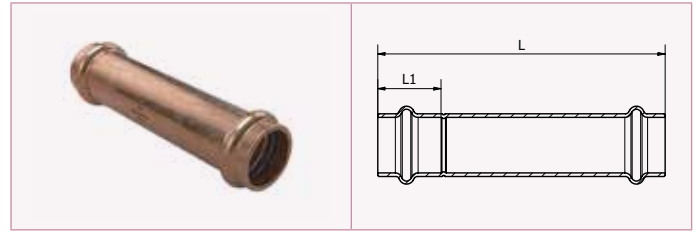

Code	Size	L	L1
MPA5275L0020001	1/4"	91.0	18.0
MPA5275L0030001	3/8"	90.0	18.0
MPA5275L0040001	1/2"	91.0	17.5
MPA5275L0050001	5/8"	101.0	21.0
MPA5275L0060001	3/4"	101.0	22.0
MPA5275L0070001	7/8"	105.0	24.0
MPA5275L0080001	1"	105.0	23.5
MPA5275L0090001	1 1/8"	106.0	25.5
MPA5275L0110001	1 3/8"	100.0	34.0
MPA5275L0130001	1 5/8"	104.0	30

24

MPA5285G SAE Copper Flare - Brass Nut

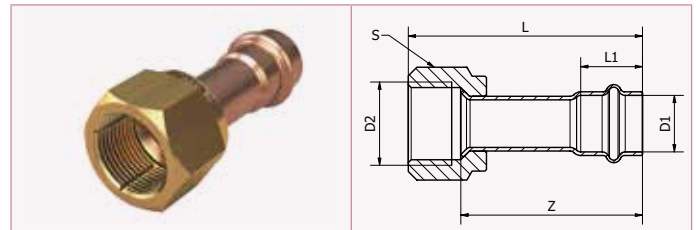

Code	Size	D1	D2	L	L1	Z	S
MPA5285G0020201	1/4"	1/4"	1/4"	54.0	18.0	46.0	17.0
MPA5285G0030301	3/8"	3/8"	3/8"	61.0	18.0	50.0	22.0
MPA5285G0040401	1/2"	1/2"	1/2"	63.5	17.5	51.5	24.0
MPA5285G0050501	5/8"	5/8"	5/8"	74.0	21.0	58.0	27.0
MPA5285G0060601	3/4"	3/4"	3/4"	81.5	22.0	63.5	34.0

MPA5286G SAE Stainless Flare - Brass Nut - Copper Washer

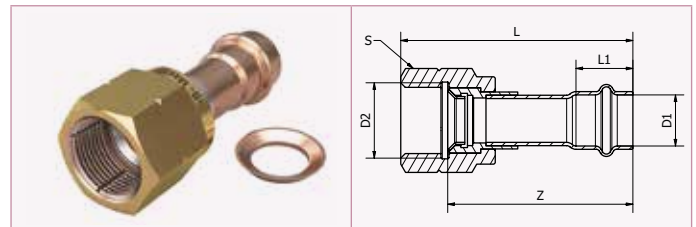

Code	Size	D1	D2	L	L1	Z	S
MPA5286G0020201	1/4"	1/4"	1/4"	64.0	18.0	55.5	17.0
MPA5286G0030301	3/8"	3/8"	3/8"	55.0	18.0	44.5	22.0
MPA5286G0040401	1/2"	1/2"	1/2"	64.5	17.5	52.5	24.0
MPA5286G0050501	5/8"	5/8"	5/8"	79.0	21.0	63.0	27.0
MPA5286G0060601	3/4"	3/4"	3/4"	85.0	22.0	67.0	34.0

Note: All above measurements are in mm unless stated differently.

>B< MaxiPro Product Range - Inch



MPA5287 Flare Copper Washer

Code	Size	L	A1
MPA5287 0020001	1/4"	3.0	45°
MPA5287 0030001	3/8"	3.5	45°
MPA5287 0040001	1/2"	4.5	45°
MPA5287 0050001	5/8"	4.5	45°
MPA5287 0060001	3/4"	6.5	45°

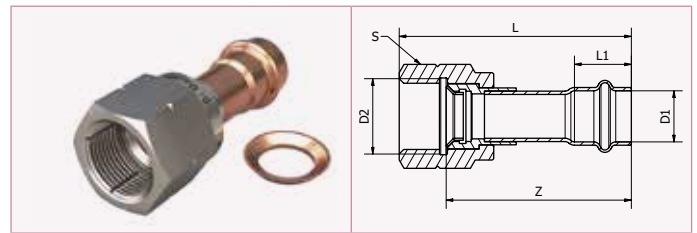

MPA5289G SAE Stainless Flare - Stainless Nut - Copper Washer

Code	Size	D1	D2	L	L1	Z	S
MPA5289G0020201	1/4"	1/4"	1/4"	64.0	18.0	55.5	17.0
MPA5289G0030301	3/8"	3/8"	3/8"	55.0	18.0	44.5	22.0
MPA5289G0040401	1/2"	1/2"	1/2"	64.5	17.5	52.5	24.0
MPA5289G0050501	5/8"	5/8"	5/8"	79.0	21.0	63.0	27.0
MPA5289G0060601	3/4"	3/4"	3/4"	85.0	22.0	67.0	34.0

25

**NOW
INCLUDING
5/16"**

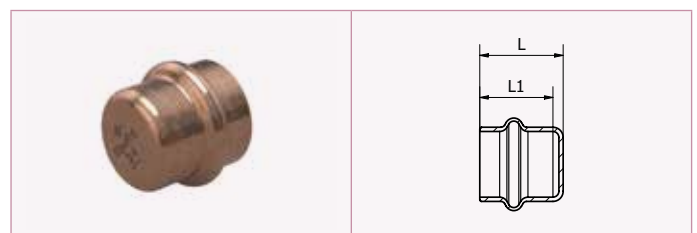

MPA5301 Stop End

Code	Size	L	L1
MPA5301 0020001	1/4"	19.5	18.0
MPA5301 5160001	5/16"	19.5	18.0
MPA5301 0030001	3/8"	19.5	18.0
MPA5301 0040001	1/2"	19.0	17.5
MPA5301 0050001	5/8"	22.5	21.0
MPA5301 0060001	3/4"	23.5	22.0
MPA5301 0070001	7/8"	26.0	24.0
MPA5301 0080001	1"	25.5	23.5
MPA5301 0090001	1 1/8"	27.5	25.5
MPA5301 0110001	1 3/8"	37.5	34.0
MPA5301 0130001	1 5/8"	34	30

Note: All above measurements are in mm unless stated differently.

>B< MaxiPro

>B< MaxiPro Product Range - Inch

NOW INCLUDING
5/16"

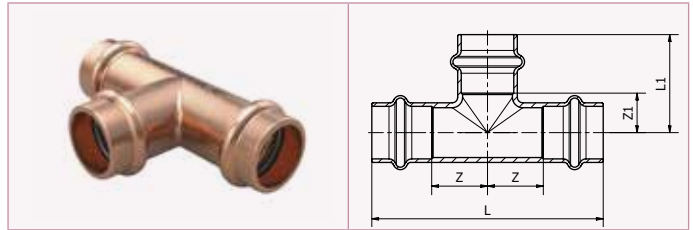

MPA5T Equal Tee

Code	Size	L	Z	L1	Z1
MPA5T 002020201	1/4"	54.0	9.0	27.0	9.0
MPA5T5165165161	5/16"	58.0	11.0	29.0	11.0
MPA5T 003030301	3/8"	63.0	13.5	31.0	13.0
MPA5T 004040401	1/2"	66.0	15.5	28.0	10.5
MPA5T 005050501	5/8"	76.0	17.0	32.0	11.0
MPA5T 006060601	3/4"	84.0	20.0	36.0	14.0
MPA5T 007070701	7/8"	89.0	20.5	38.5	14.5
MPA5T 008080801	1"	92.0	22.5	40.0	16.5
MPA5T 009090901	1 1/8"	95.0	22.0	43.0	17.5
MPA5T 011111101	1 3/8"	112.0	22.0	56.0	22.0
MPA5T 013131301	1 5/8"	140	39.5	70.5	39.5

26

MPA5698 P-Trap

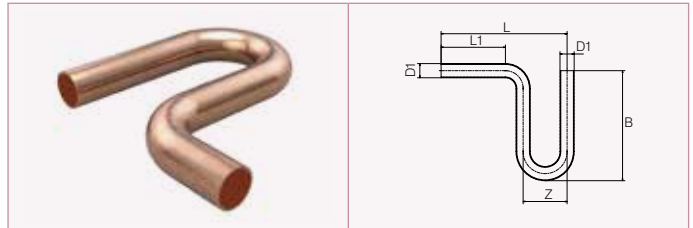

Code	Size	D1	L	L1	B	Z
MPA5698 0050001	5/8"	5/8"	171.0	103.5	151.5	45.0
MPA5698 0060001	3/4"	3/4"	172.0	91.0	158.5	54.0
MPA5698 0070001	7/8"	7/8"	171.0	72.0	170.0	66.0
MPA5698 0090001	1 1/8"	1 1/8"	170.0	44.0	173.5	84.0

Note: Not UL approved.

NEW

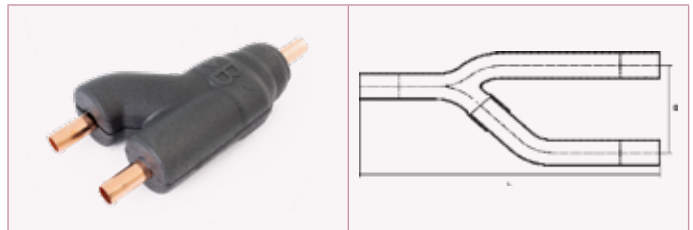

MPA5R >B< Flow Y-Joint (with Insulation)

Code	Size	L	D
MPBF5 0030303F1	3/8"	160	58
MPBF5 0040404F1	1/2"	170	58
MPBF5 0050505F1	5/8"	180	60
MPBF5 0060606F1	3/4"	190	63
MPBF5 0070707F1	7/8"	220	70
MPBF5 0090909F1	1 1/8"	260	80

Note: All above measurements are in mm unless stated differently.

>B< MaxiPro Product Range - Inch

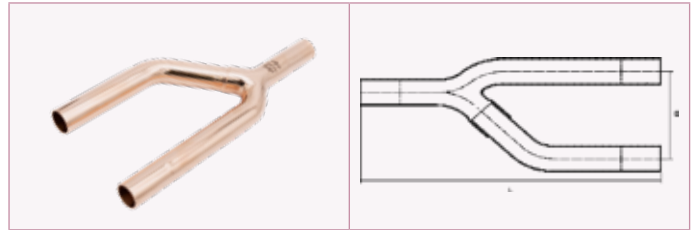

MPA5R

>B< Flow Y-Joint (without Insulation)

Code	Size	L	D
MPBF5 003030301	3/8"	160	58
MPBF5 004040401	1/2"	170	58
MPBF5 005050501	5/8"	180	60
MPBF5 006060601	3/4"	190	63
MPBF5 007070701	7/8"	220	70
MPBF5 009090901	1 1/8"	260	80

MPA Depth Gauge Depth Gauge + Pen



Code	Description
MPA Depth Gauge	>B< MaxiPro Depth Gauge + Pen Inch 1/4" to 1 3/8"

MPABPSOIL Press Fitting Lubricant



Code	Size
MPABPSOIL100ML	100 ml

Note: All above measurements are in mm unless stated differently.

17. >B< MaxiPro Product Range - Metric

MPM5001 90° Street Bend

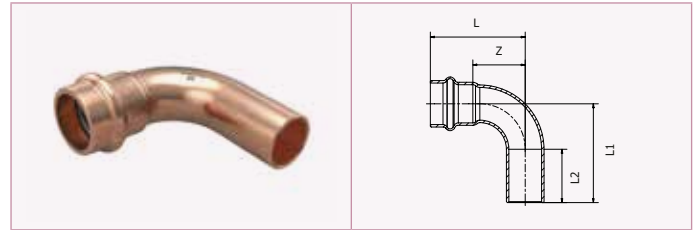

Code	Size	L	L1	L2	Z
MPM5001 0060001	6 mm	32.5	34.5	21.0	14.5
MPM5001 0080001	8 mm	33.0	36.0	21.0	15.0
MPM5001 0100001	10 mm	33.0	37.0	21.0	15.0
MPM5001 0120001	12 mm	33.0	37.0	21.0	15.0
MPM5001 0150001	15 mm	38.0	44.0	25.0	18.0
MPM5001 0160001	16 mm	39.0	45.0	24.0	18.0
MPM5001 0180001	18 mm	43.5	48.5	25.0	22.0
MPM5001 0220001	22 mm	50.0	53.0	27.0	26.0
MPM5001 0280001	28 mm	57.0	61.5	28.5	31.5

MPM5002 90° Bend

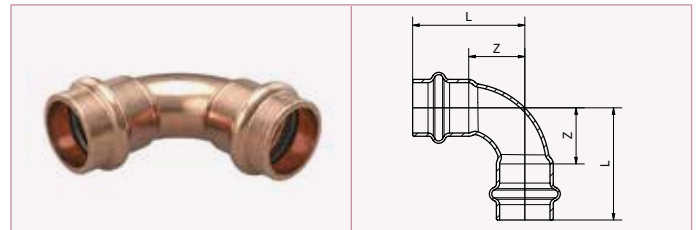

Code	Size	L	Z
MPM5002 0060001	6 mm	32.5	14.5
MPM5002 0080001	8 mm	33.0	15.0
MPM5002 0100001	10 mm	33.0	15.0
MPM5002 0120001	12 mm	33.0	15.0
MPM5002 0150001	15 mm	39.5	18.0
MPM5002 0160001	16 mm	39.0	18.0
MPM5002 0180001	18 mm	40.5	18.5
MPM5002 0220001	22 mm	50.0	26.0
MPM5002 0280001	28 mm	57.0	31.5

>B< MaxiPro Product Range - Metric

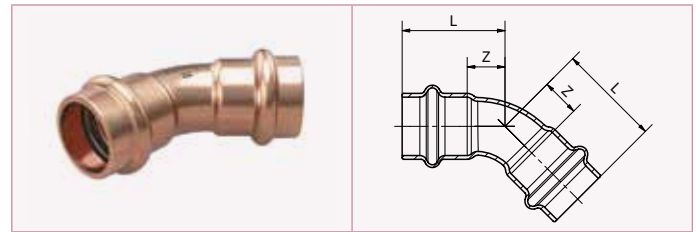

MPM5041 45° Obtuse Elbow

Code	Size	L	Z
MPM5041 0060001	6 mm	23.5	5.5
MPM5041 0080001	8 mm	24.0	6.0
MPM5041 0100001	10 mm	24.0	6.0
MPM5041 0120001	12 mm	24.0	6.0
MPM5041 0150001	15 mm	30.0	8.0
MPM5041 0160001	16 mm	28.0	7.0
MPM5041 0180001	18 mm	31.0	8.0
MPM5041 0220001	22 mm	34.0	10.0
MPM5041 0280001	28 mm	39.5	14.0

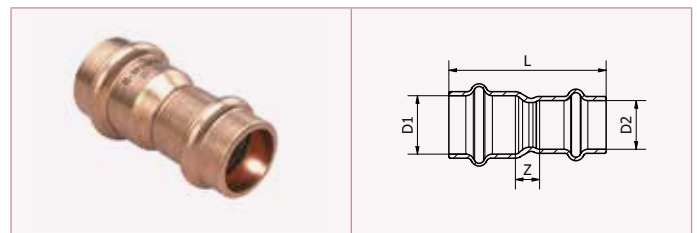

MPM5240 Reducing Coupler

Code	Size	L	Z	D1	D2
MPM5240 0080101	8 x 6 mm	42.5	5.5	8	6
MPM5240 0100601	10 x 6 mm	45.0	8.0	10	6
MPM5240 0100801	10 x 8 mm	43.0	6.0	10	8
MPM5240 0120601	12 x 6 mm	47.0	10.0	12	6
MPM5240 0120801	12 x 8 mm	45.5	8.0	12	8
MPM5240 0121001	12 x 10 mm	43.5	6.5	12	10
MPM5240 0150801	15 x 8 mm	51.0	11.0	15	8
MPM5240 0151001	15 x 10 mm	49.0	9.0	15	10
MPM5240 0151201	15 x 12 mm	46.5	6.5	15	12
MPM5240 0161001	16 x 10 mm	50.0	10.0	16	10
MPM5240 0161201	16 x 12 mm	47.5	7.5	16	12
MPM5240 0181001	18 x 10 mm	53.0	12.0	18	10
MPM5240 0181201	18 x 12 mm	50.5	9.5	18	12
MPM5240 0181501	18 x 15 mm	51.0	7.0	18	15
MPM5240 0221201	22 x 12 mm	56.0	13.0	22	12
MPM5240 0221501	22 x 15 mm	56.5	10.5	22	15
MPM5240 0221601	22 x 16 mm	55.5	9.5	22	16
MPM5240 0221801	22 x 18 mm	55.0	8.0	22	18
MPM5240 0281501	28 x 15 mm	64.0	16.5	28	15
MPM5240 0281601	28 x 16 mm	55.0	15.5	28	16
MPM5240 0281801	28 x 18 mm	62.0	13.5	28	18
MPM5240 0282201	28 x 22 mm	60.0	10.5	28	22

Note: All above measurements are in mm unless stated differently.

>B< MaxiPro Product Range - Metric

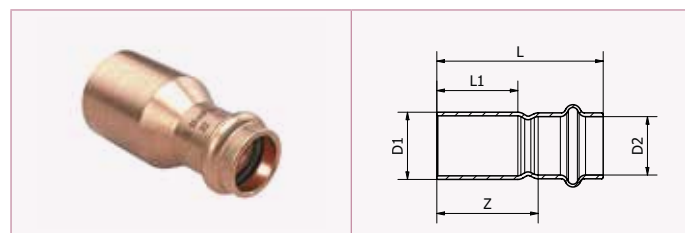

MPM5243 Fitting Reducer

Code	Size	L	L1	Z	D1	D2
MPM5243 0080601	8 x 6 mm	44.5	21.0	25.5	8	6
MPM5243 0100601	10 x 6 mm	45.5	21.0	26.5	10	6
MPM5243 0100801	10 x 8 mm	44.0	21.0	25.0	10	8
MPM5243 0120601	12 x 6 mm	47.0	21.0	28.0	12	6
MPM5243 0120801	12 x 8 mm	46.0	21.0	27.0	12	8
MPM5243 0121001	12 x 10 mm	44.5	21.0	25.5	12	10
MPM5243 0150601	15 x 6 mm	53.0	24.0	34.0	15	6
MPM5243 0150801	15 x 8 mm	51.5	24.0	32.5	15	8
MPM5243 0151001	15 x 10 mm	49.5	24.0	30.5	15	10
MPM5243 0151201	15 x 12 mm	47.0	24.0	28.0	15	12
MPM5243 0160601	16 x 6 mm	53.5	24.0	34.5	16	6
MPM5243 0160801	16 x 8 mm	52.0	24.0	33.0	16	8
MPM5243 0161001	16 x 10 mm	50.5	24.0	31.5	16	10
MPM5243 0161201	16 x 12 mm	54.0	24.0	29.0	16	12
MPM5243 0181001	18 x 10 mm	53.0	25.0	34.0	18	10
MPM5243 0181201	18 x 12 mm	51.0	25.0	31.5	18	12
MPM5243 0181501	18 x 15 mm	51.0	25.0	29.0	18	15
MPM5243 0181601	18 x 16 mm	47.0	25.0	26.5	18	16
MPM5243 0221201	22 x 12 mm	56.0	27.0	38.0	22	12
MPM5243 0221501	22 x 15 mm	56.5	27.0	34.5	22	15
MPM5243 0221601	22 x 16 mm	55.5	27.0	33.5	22	16
MPM5243 0221801	22 x 18 mm	55.0	27.0	32.0	22	18
MPM5243 0281501	28 x 15 mm	63.5	28.5	41.0	28	15
MPM5243 0281601	28 x 16 mm	59.5	28.5	40.5	28	16
MPM5243 0281801	28 x 18 mm	61.5	28.5	38.5	28	18
MPM5243 0282201	28 x 22 mm	59.0	28.5	35.0	28	22

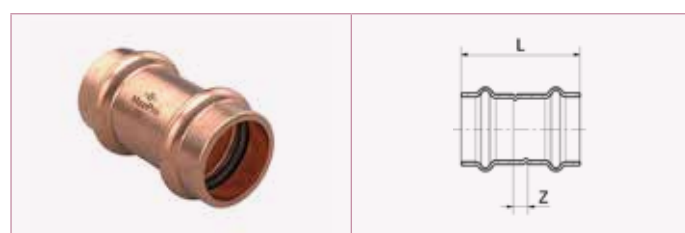

MPM5270 Straight Coupler

Code	Size	L	Z
MPM5270 0060001	6 mm	39.0	3.0
MPM5270 0080001	8 mm	39.0	3.0
MPM5270 0100001	10 mm	39.0	3.0
MPM5270 0120001	12 mm	42.0	6.0
MPM5270 0150001	15 mm	50.5	6.5
MPM5270 0160001	16 mm	45.0	3.0
MPM5270 0180001	18 mm	46.5	2.0
MPM5270 0220001	22 mm	56.5	8.5
MPM5270 0280001	28 mm	57.0	6.0

Note: All above measurements are in mm unless stated differently.

>B< MaxiPro Product Range - Metric

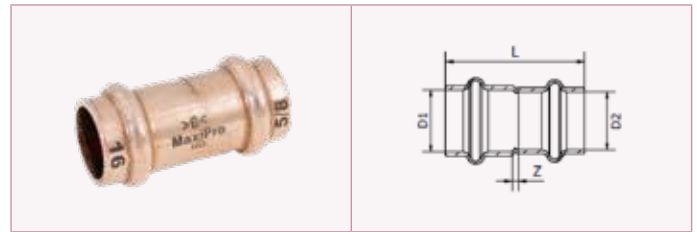

MPM5273 Imperial to Metric Adaptors

Code	Size	D1	D2	L	Z
MPM5273 0020601	¼" x 6 mm	¼"	6 mm	39	3
MPM5273 0031001	⅜" x 10 mm	⅜"	10 mm	39	3
MPM5273 0041201	½" x 12 mm	½"	12 mm	40	4.5
MPM5273 0051601	⅝" x 16 mm	⅝"	16 mm	45	3
MPM5273 0061801	¾" x 18 mm	¾"	18 mm	48	4
MPM5273 0072201	⅞" x 22 mm	⅞"	22 mm	56.5	8.5
MPM5273 0092801	1 ⅛" x 28 mm	1 ⅛"	28 mm	57	6

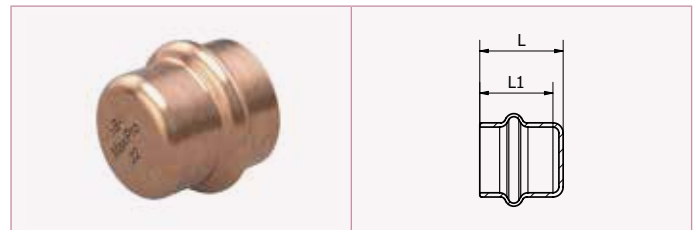

MPM5301 Stop End

Code	Size	L	L1
MPM5301 0060001	6 mm	19.5	18.0
MPM5301 0080001	8 mm	19.5	18.0
MPM5301 0100001	10 mm	19.5	18.0
MPM5301 0120001	12 mm	20.5	18.0
MPM5301 0150001	15 mm	25.0	21.0
MPM5301 0160001	16 mm	22.5	21.0
MPM5301 0180001	18 mm	22.0	22.0
MPM5301 0220001	22 mm	26.0	24.0
MPM5301 0280001	28 mm	27.5	25.5

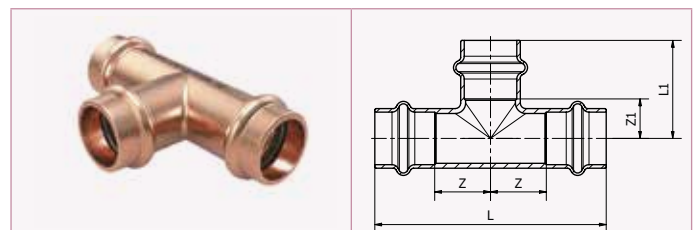

MPM5T Equal Tee

Code	Size	L	Z	L1	Z1
MPM5T 006060601	6 mm	54.0	9.0	27.0	9.0
MPM5T 008080801	8 mm	58.0	11.0	29.0	11.0
MPM5T 010101001	10 mm	61.0	12.5	30.0	12.0
MPM5T 012121201	12 mm	72.0	18.0	28.0	10.0
MPM5T 015151501	15 mm	82.0	19.0	33.0	11.0
MPM5T 016161601	16 mm	76.0	17.0	32.0	11.0
MPM5T 018181801	18 mm	83.0	17.0	37.5	13.0
MPM5T 022222201	22 mm	89.0	20.5	38.5	14.5
MPM5T 028282801	28 mm	95.0	22.0	43.5	17.5

Note: All above measurements are in mm unless stated differently.

>B< MaxiPro

>B< MaxiPro Product Range - Metric



Mother Jaw

Code	Description
MJ03CB19KN	Mother Jaw 19 kN press tool
MJ03CB32KN	Mother Jaw 32kN press tool



MPM01INS Insert Metric

Code	Size
MPM01INS19006	6 mm
MPM01INS19008	8 mm
MPM01INS19010	10 mm
MPM01INS19012	12 mm
MPM01INS19015	15 mm
MPM01INS19016	16 mm
MPM01INS19018	18 mm
MPM01INS19022	22 mm
MPM01INS19028	28 mm

>B< MaxiPro Product Range - Metric



MPMTOOLCASE03 Tool Case, Mother Jaw and 9 Metric Inserts*

Code	Description
MPMTOOLCASE03	>B< MaxiPro Tool Case, Mother Jaw and 9 Metric Inserts

* **Contents:** Mother jaw, 9 inserts 6-28 mm, rotary tube cutter, deburrer, pencil deburrer, depth gauge, marker pen and cleaning pads.



MPM Depth Gauge Depth Gauge + Pen

Code	Description
MPM Depth Gauge	Depth Gauge + Pen Metric 6 - 35 mm

18. Extended Guarantee

When professionally installed by a trained and certified >B< MaxiPro installer*, and used and maintained in accordance with the installation and maintenance instructions detailed in the >B< MaxiPro technical brochure, Conex Universal Ltd. guarantees that >B< MaxiPro fittings as supplied by Conex Universal Ltd. will be free of material defects resulting from errors in manufacture, for ten (10) years from the date of first purchase by an end user. This Guarantee is limited to the repair or replacement of defective product(s) (at the sole discretion of Conex Universal Ltd.). At the request of Conex Universal Ltd. the allegedly defective product(s) must be returned to the address adjacent** and Conex Universal Ltd. reserves the right to inspect and test the alleged defects. This guarantee provided by Conex Universal Ltd. does not affect your statutory rights.

The Guarantee set out above is given by Conex Universal Ltd. and subject to the following conditions:

A. Any alleged defects must be reported to Conex Universal Ltd. within one month of the first occurrence of any such alleged defect, clearly setting out the nature of the claim and the circumstances surrounding it.

B. Conex Universal Ltd. shall be under no liability in respect of any defect in any product arising from:

- defective installation,
- fair wear and tear,
- wilful damage,
- negligence of any party other than Conex Universal Ltd.,
- abnormal working or environmental conditions,
- failure to follow the instructions of Conex Universal Ltd.,
- misuse (which includes any use of the product(s) concerned for a purpose or in a situation / environment or for an application other than that for which it was designed), or
- alteration or repair of any product without the prior approval of Conex Universal Ltd.

C. At the request of Conex Universal Ltd. the person claiming under this guarantee must deliver to Conex Universal Ltd. written evidence of the date of first purchase by an end user of the product(s) concerned.

*For the installer to be suitably trained and certified for the purposes of this Product Guarantee the installer must have attended and passed a course on the >B< MaxiPro product held or expressly approved by Conex Universal Limited in relation to the use and installation of the >B< MaxiPro product.

**** The address for returns is:**

Customer Services
Conex Universal Limited
Global House
95 Vantage Point
The Pensnett Estate
Kingswinford
West Midlands
DY6 7FT
UNITED KINGDOM

19. Abbreviations

AB oil	Alkyl Benzene oil.
ASTM-B280-13	American Standard Specification for Seamless Copper Tube for Air Conditioning and Refrigeration Field Service.
CDA	Copper Development Association.
CFT	Constant Force Technology.
EN 378-2:2016	European Standard for Refrigerating systems and heat pumps. Safety and environmental requirements. Design, construction, testing, marking and documentation.
EN 12735-1:2016	European Standard for Copper and copper alloys. Seamless, round copper tubes for air conditioning and refrigeration. Tubes for piping systems.
EN 12735-2: 2016	Copper and copper alloys - Seamless, round tubes for air conditioning and refrigeration - Part 2: Tubes for equipment.
EN 14276-2:2020	European Standard for Pressure equipment for refrigerating systems and heat pumps. Piping. General requirements.
HNBR	Hydrogenated Nitrile Butadiene Rubber.
ISO 5149-2:2014	International Standard for Refrigerating systems and heat pumps - Safety and environmental requirements - Part 2: Design, construction, testing, marking and documentation.
ISO 9001	Certified quality management system.
ISO 14903:2017	International Standard for Refrigerating systems and heat pumps - Qualification of tightness of components and joints. Section 7.6 Pressure temperature vibration tests (PTV).
LED	Light Emitting Diode.
PAO oil	Poly-alpha-olefin oil.
POE oil	Polyolester oil.
PVE oil	Polyvinylether oil.
SMS	Short Message Service.
UL 207	Standard for Refrigerant-Containing Components and Accessories, Nonelectrical.
UL 1963 - 79	Standard for Refrigerant Recovery / Recycling Equipment. Section 79 Tests of Gaskets and Seals Used in Refrigerant Systems.
UL 109 - 7	Standard for Tube Fittings for Flammable and Combustible Fluids, Refrigeration Service, and Marine Use. Section 7 Pull test.
UL 109 - 8	Standard for Tube Fittings for Flammable and Combustible Fluids, Refrigeration Service, and Marine Use. Section 8 Vibration test.
UNS	Unified Numbering System.

20. Frequently Asked Questions

- 1. How long is the Conex Banninger business heritage?**
Since 1909.
- 2. Where are the >B< MaxiPro fittings manufactured?**
The products are manufactured in Europe.
- 3. Does >B< MaxiPro work on both hard and soft copper?**
Yes, >B< MaxiPro is a press fitting system for use with hard, half hard or annealed copper tube. Please refer to >B< MaxiPro - Tube Compatibility Tables, see section 12.10.
- 4. Can you use >B< MaxiPro to crimp to aluminium, steel, or stainless steel?**
No, >B< MaxiPro is specifically designed for copper to copper connections. Connecting to dissimilar metals can cause corrosion issues that could cause a failure.
- 5. What is the guarantee on >B< MaxiPro fittings?**
When professionally installed by a trained and certified >B< MaxiPro installer, >B< MaxiPro has a ten (10) year extended guarantee from the first date of purchase. Please refer to full terms and conditions, see section 17.
- 6. What material is the O-ring made of?**
The O-ring is manufactured from Hydrogenated Nitrile Butadiene Rubber (HNBR).
- 7. What is the expected life of the O-ring in the system?**
The O-ring is manufactured by Germany's leading producer of O-rings. The expected life of the O-ring if used within the product specifications for temperature and pressure is at least 25 years.
- 8. Are there any storage issues, including where the fittings are stored in vehicles and exposed to extremes of high or low temperature?**
No, the product is not subject to degradation under normal storage conditions. Provided it is kept in original packaging and not exposed to direct sunlight for long periods. Please see section 10. for details regarding fitting storage.
- 9. What refrigerants is >B< MaxiPro compatible with**
>B< MaxiPro is compatible with R-1234yf**, R-1234ze**, R-125, R-134a, R-290**, R-32**, R-404A, R-407A, R-407C, R-407F, R-407H, R-410A, R-417A, R-421A, R-422B, R-422D, R-424A, R-427A, R-434A, R-437A, R-438A, R-444A**, R-447A**, R-447B**, R-448A, R-449A, R-450A, R-452A, R-452B**, R-452C, R-453A, R-454A**, R-454B**, R-454C**, R-455A**, R-456A, R-457A**, R-459A**, R-507A, R-513, R-513A, R-513B, R-515B, R-600A**, R-718, Ethylene Glycol and HYCOOL 20.

** When using refrigerants classified A2L (lower flammability), A2 (flammable) and A3 (higher flammability) additional/specific standards, local rules and regulations, codes of practice and by-laws may be applicable.
Note: >B< MaxiPro fittings are NOT suitable for R-717, R-723, R-764, R-744, R-22 refrigerants. Please check our website www.conexbanninger.com for updates on the >B< MaxiPro range.
- 10. What oils are approved for use with >B< MaxiPro?**
>B< MaxiPro is approved for use with POE, PAO, PVE, AB and MO.
- 11. If a fitting leaks on installation, can you braze the fitting rather than cutting out the joint and having to replace missing tube?**
No, if a fitting that has been pressed is leaking, the fitting must be cut out and replaced. You should not attempt to braze the fitting as you may melt the O-ring material and thus introduce contaminants into the system that could cause other system issues.
- 12. Is there a concern about ice building up and then thawing under the fitting in a horizontal or vertical configuration?**
No, >B< MaxiPro has been thoroughly freeze / thaw tested. ISO 14903 - Freeze / thaw test, compliant.
- 13. Are there any concerns with corrosion where installations are made in coastal areas or with respect to cleaning agents?**
No, >B< MaxiPro has been Acid Salt Spray tested to ASTM G85. As with all copper installations exposure to ammonia should be avoided.
- 14. How do you know when the tool needs to be serviced?**
Please refer to manufacturers operating instructions for servicing requirements.
- 15. Do >B< MaxiPro jaws need servicing?**
Please refer to manufacturers operating instructions for servicing requirements.
- 16. Do Conex Banninger >B< MaxiPro Inserts need servicing?**
Inserts are a non service item and should be checked periodically for wear and tear, with worn inserts replaced. Inserts should be replaced every 2 years.
- 17. Are the >B< MaxiPro jaws compatible with any other commercially available crimping tool?**
Please see section 14. Press Tool and Jaw Compatibility. For updates on tool and jaw compatibility please visit www.conexbanninger.com.
- 18. What approvals are held by >B< MaxiPro?**
>B< MaxiPro is UL listed, refrigerant fitting SA44668.
>B< MaxiPro is UL listed, approved use for field and factory installations.
UL 109 - 8 Vibration test, compliant.
UL 1963 - 79 Tests of gaskets and seals used in refrigerant systems, compliant.
ISO 5149-2, EN 378-2, Refrigerating systems and heat pumps - Safety and environmental requirements – Part 2: Design, construction, testing, marking and documentation, compliant.
ISO 5149-2, EN378-2 5.3.2.2.3 Strength pressure test, compliant.
EN 14276-2 - 8.9.4.1.2 Type burst proof test, compliant.
ISO 14903 - 7.4 Tightness test, compliant.
ISO 14903 - 7.6 Pressure temperature vibration tests (PTV), compliant.

ISO 14903 - 7.8 Freezing test, compliant.
 ASTM G85 salt spray (fog) test, compliant.
 ISO 14903 - 7.6 Pressure temperature vibration tests (PTV), compliant.
 ISO 14903 - 7.8 Freezing test, compliant.
 ASTM G85 salt spray (fog) test, compliant.

19. **What copper tubes are compatible with >B< MaxiPro?**

>B< MaxiPro is a press fitting system for use with hard, half hard or annealed copper tube. Please refer to >B< MaxiPro tube compatibility table, see section 12.10.

20. **Does the O-ring compensate for imperfections in the tube to make a tight seal?**

Yes, the O-ring does compensate for small/minor scratches on the surface of the tube. However imperfections adjacent to the crimp area such as scratches, incise marks, and tubing that is not round must be avoided.

21. **The product specifications state that the application temperature limits are -40 °C to 121 °C. What happens if we go beyond that limit?**

>B< MaxiPro is suitable for continuous operating at temperatures between -40 °C and +121 °C. It will also cope with short term excursions up to 140 °C. Operating at temperatures outside this range is not acceptable and may lead to failure.

22. **How clean are >B< MaxiPro fittings?**

>B< MaxiPro fittings comply with the cleanliness standards as required in the following Copper Tube Standards EN 12735-1, EN 12735-2 and ASTM-B280. Keep the ziplock bag sealed to protect fittings from contamination.

23. **How do the fittings cope with vibration from the system?**

Vibration is a recognised cause of leaks and the system must be designed and installed to comply with all local standards and codes of practice which aim to minimise vibration.

>B< MaxiPro fittings have been extensively tested to ensure the joint will not leak as a result of system vibration and complies with the following standards:

- ISO 14903 temperature pressure cycling and vibration test
- UL 109 - 8 vibration test
- UL 207 fatigue shock test

24. **Will the O-ring be damaged if acid develops in the refrigeration system?**

Good installation practice, a nitrogen purge during any brazing (not required with >B< MaxiPro mechanical fittings), a deep evacuation, and the proper installation and use of filter-driers containing modern and effective molecular sieve desiccants will prevent many system failures. Including the build up of acid within the system.

When selecting which desiccant material is best for an application, water capacity, refrigerant and lubricant compatibility, acid capacity, and physical strength are important characteristics and should be considered.

25. **When pressed, small size fittings, particularly elbows may allow a small amount of rotational movement to be induced at the joint. Will this affect the security of the joint?**

No, some rotational movement is quite acceptable, the joint will not leak nor will it come apart under pressure loading and during system operation. Some joint movement is good as it will allow for expansion and contraction in the pipework system.

26. **Is >B< MaxiPro suitable for medical gas applications?**

No, >B< MaxiPro is not suitable for medical gas applications.

27. **Can you press a fitting more than once?**

No >B< MaxiPro fittings can be pressed only once.

28. **Is >B< MaxiPro approved for drinking water systems?**

No >B< MaxiPro is not approved for drinking water systems.

29. **Can >B< MaxiPro be used on heating and hot water systems?**

No >B< MaxiPro is approved for use in air conditioning and refrigeration applications only.

30. **If my system fails to achieve or hold a vacuum what should I do?**

Problem Solving Vacuum Evacuation

Vacuum evacuation removes air, moisture, and non-condensable gases prior to system charging.

Failure to achieve a vacuum:

- A leak or moisture in the system (see below).
- Vacuum pump not working correctly.
- Vacuum pump does not have sufficient capacity.

Failure to hold a vacuum:

- A leak in the system or the connections to the system – find all leaks and repair them.
 - An ultrasonic leak detector can help pinpoint leaks on a system under vacuum.
- Moisture or refrigerant still in the system – continue evacuation.
- No remedial action e.g. cutting out fittings from the system should be taken until a proper fault finding exercise has been completed.

31. **I am having a problem achieving a seal on a flared connection what should I do?**

If you cannot achieve a seal on a flared connection, place a small drop of Conex Bänninger press fitting lubricant on the sealing face.

Notes:

Dotted lines for notes.

›B‹ Press

›B‹ Press Gas

›B‹ Press Solar

›B‹ Press XL

›B‹ Press Carbon

›B‹ Press Inox

›B‹ Steel

›B‹ MaxiPro

›B‹ ACR

K65

‹A› Press Inox

›B‹ Push

›B‹ Sonic

›B‹ Oyster

›B‹ Flex

Triflow Solder Ring

Delcop End Feed

Delbraze

Medical Gas

Valves

Conex Compression

Series 3000

Series 4000

Series 5000

Series 8000

OEM Solutions



United Kingdom
Conex Universal Limited

Germany
IBP GmbH

Spain
IBP Atcosa SL

France
Conex Bänninger SRL

Italy
IBP Bänninger Italia srl

Poland Sales, Marketing and Logistics
IBP Instal fittings Sp z.o.o.

USA
IBP Group LLC

China
IBP China

Tel: +44 (0)121 557 2831 | Fax: +44 (0)121 557 0185 | Email: international@ibpgroup.com | www.conexbanninger.com

The content of this publication is for general information only. It is the user's responsibility to determine suitability of any product, product data and specifications, for the purpose intended and reference should be made to our Technical Department if clarification is required – technical@ibpgroup.com. All products must be installed in accordance with our installation instructions. In the interests of technical development we reserve the right to change specification, design and materials without notice.

Conex Bänninger products are approved by numerous Standards Authorities and Certification Bodies. This is a representation of the full range from Conex Universal Ltd. Patents and trademarks are registered in numerous countries. Details on registered and pending patents protecting our products is available at public patent registers or can be requested from legal@ibpgroup.com. All documents, images and technical data are © of Conex Universal Limited. E&OA.

More information online at: www.conexbanninger.com