

INNOVATE 26

sensio[®]

New Product
Launches 25/26



MAKING LIGHTING SIMPLE™

Forever innovating
beautifully simple lighting
solutions for kitchens
and bedrooms

Illlumination

We're excited to introduce you to our next generation of product developments.

Our in-house design team have been hiding away in the lab, analysing and evaluating to bring new solutions to the table, which we believe to be truly innovative.

Over the course of this booklet, we'll reveal next gen thinking on flexible strips and beautifully designed accessories which integrates into kitchen furniture so well, you'll hardly notice it...

...until you switch on the lights!



Making Lighting Simple



Market Leading Innovation



Extraordinary Service

FREE-CUT	p8
Razor X 2mm	p10
Razor X 4mm	p12
Razor X Pro 2mm	p14
Razor X Pro 4mm	p16
Polar X	p18
Polar X Pro	p20
Primo X	p22
PIXEL - SHEETS OF LIGHT	p24
Pixel	p26
Pixel Pro	p28
AFFINITY - GAME CHANGING LIGHTING	p30
Magnetic Track	p32
Under cabinet lighting	p33
USB / USB-C Charging Port	p34
IR Sensor	p34
Faraday X	p35
Affinity Accessories	p36
INTEGRATED PROFILES	p38
Versa surface mounted profile	p40
Versa recessed profile	p42
Vertex	p44
POWER - DRIVERS, CONNECTORS & CONTROLS	P46
Universal Connector	p48
TrioTone® Control	p49
JB4 Detachable Driver Connectors	p50
Titan Dimmable	p52
Titan+ Driver	p53
Titan Smart Kinetic Driver	p53
Titan+ Wireless Sensor Range	p54

WHERE REAL-WORLD INSIGHT SHAPES **INNOVATION**

At the heart of our process is a simple principle, **we listen first.**

Every product we create begins with a conversation. By spending real time with our customers, on site and in their working environments, we gain first hand insight into how our products are used in the field. These collaborative reviews allow us to see challenges, opportunities, and creative adaptations that can only be understood through genuine interaction.

From these sessions, our design and engineering teams return not just with feedback, but with purpose. Each improvement we make is intentional, driven by real-world application and the desire to craft lighting solutions that feel considered, functional, and truly built for the people who rely on them every day.



“

Innovation doesn't start in the studio, it starts on site with the installer.”

Charles Offord, Product Designer

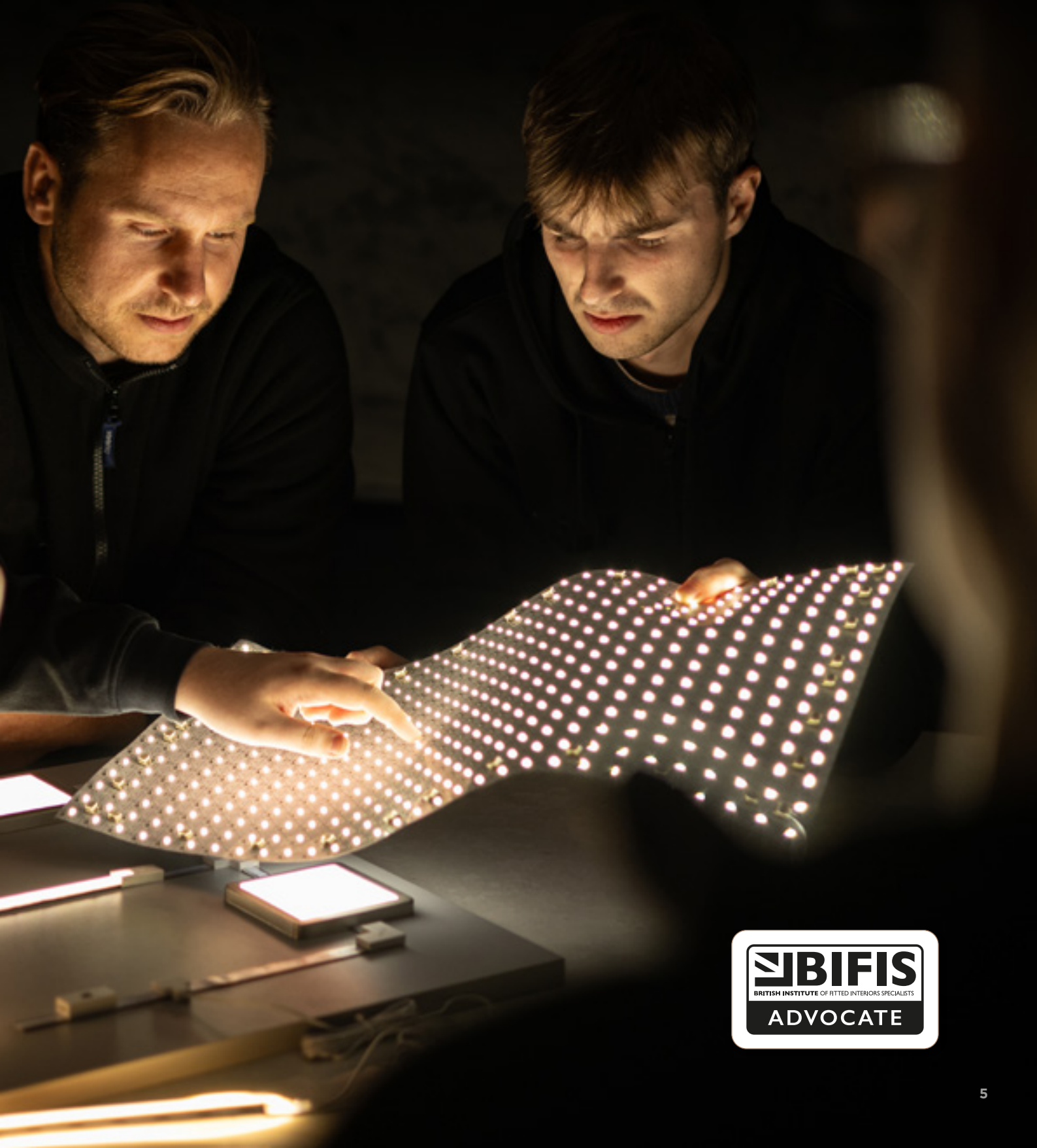



“At the heart of our process is a simple principle, we listen first. The most valuable part of what we do isn’t the prototype, it’s the conversation that shapes it.”

Fariz Khellaf, Ph.D

Global Chief Technology Officer





Polar X

Polar X Pro

Primo X



FREE-CUT

Evolving our X-SERIES flexible LED strip systems

Back by popular demand, we have enhanced our x freecut series to include a wider variety of our LED range.

The X-series is cuttable at any length delivering precision for installation leaving no dark spots. Combined with additional connector and cable kits the x-series allows for any lengths to be used eliminating potential waste which is more cost effective.

RAZOR X 2MM

Free-Cut Recessed LED Strip

A super-slim evolution of our fully diffused Polar COB strip. The Razor X 2mm has a thin 2mm width providing a discrete appearance, while still offering a fully diffused light output.

The edge lit design allows the Razor X 2mm to be recessed into a narrow channel, creating a sleek lighting effect. Bending around corners beautifully for unique design installations.

- Single Colour: Choose Natural white light (4000K) or Warm light (3000K).
- Free cut: Can be cut to any desired length.
- Chip on Board (COB): Technology provides seamless light output and efficiency.
- Recessed Installation: Easily recessed with a saw cut or router.
- Bendable: Easily flow around corner recesses
- Push fit install: No VHB adhesive backing for easy push fit installation.
- Compatibility: Adjust brightness when paired with Sensio controls and drivers.
- Connection: Pre-soldered 2.5m driver connection cables at each end.
- Accessories: Additional driver connection cable (sold separately) to utilise all cut lengths.
- Profiles: Pair with the Edge profile, designed specifically for the Razor X strip.
- Registered design right: 6371779.

Push-fit in a routed channel



Cut the Razor X at any point to achieve the perfect fit.

**Ideal for bespoke
routed 2mm channels
produced with a
circular saw.**

2mm

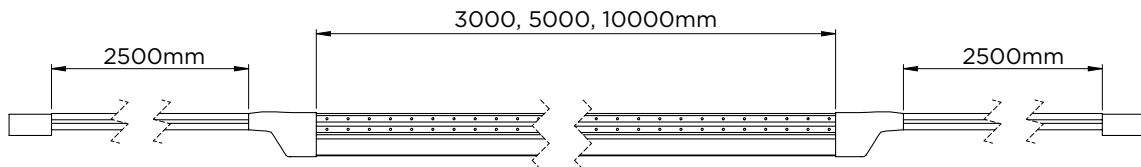
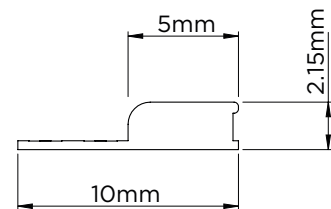

Natural White - 4000K | 512 LED/m

SKU	Length	Dimensions	Wattage	Lumens	Colour	RRP
SE21094N0	3m	10mm x 2.15mm	6W/m	508lm/m	Natural	£67.85
SE21095N0	5m	10mm x 2.15mm	6W/m	508lm/m	Natural	£114.48
SE21096N0	10m	10mm x 2.15mm	6W/m	508lm/m	Natural	£218.23

Warm White - 3000K | 512 LED/m

SKU	Length	Dimensions	Wattage	Lumens	Colour	RRP
SE21094W0	3m	10mm x 2.15mm	6W/m	508lm/m	Warm	£67.85
SE21095W0	5m	10mm x 2.15mm	6W/m	508lm/m	Warm	£114.48
SE21096W0	10m	10mm x 2.15mm	6W/m	508lm/m	Warm	£218.23

Accessories

SKU	Accessory	Cable length	RRP
SE900980	Razor X Driver Connection Cable Kit (Left & Right)	2500mm	£6.72
SE210019A0	Razor X Interconnecting Cable	1500mm	£3.22
SE9009	Extension Lead	2500mm	£3.94

RAZOR X 4MM

Free-Cut Recessed LED Strip

Razor X 4mm is a chip-on-board (COB) lighting solution, designed with manufacturers in mind. Available with or without wings. Its 4mm width fits perfectly into grooves made with standard saw blades, whether cut on-site or in the factory. The flexible, edge-lit design allows the strip to bend around curves and corners with ease.

- Single Colour: Choose Natural white light (4000K) or Warm light (3000K).
- Free cut: Can be cut to any desired length.
- Chip on Board (COB): Technology provides seamless light output and efficiency.
- Recessed Installation: For anyone with routing capabilities, either CNC machine or hand routing.
- Bendable: Easily flow around corner recesses.
- Push fit install: No VHB adhesive backing for easy push fit installation.
- Winged version available: For a clean finish to cover routing imperfections.
- Flexible driver connection cable: For either side or back cable placement.
- Compatibility: Adjust brightness when paired with Sensio controls and drivers.
- Connection: Pre-soldered 2.5m driver connection cables at each end.
- Accessories: Additional driver connection cable (sold separately) to utilise all cut lengths.
- Registered design right: 6371779 (winged): 6443845.



“Designed with manufacturers in mind.”

Product Design Team,
Sensio.

Flexible connection creates clean cable management by carrying the wire straight back through a drilled hole, in the routed channel.



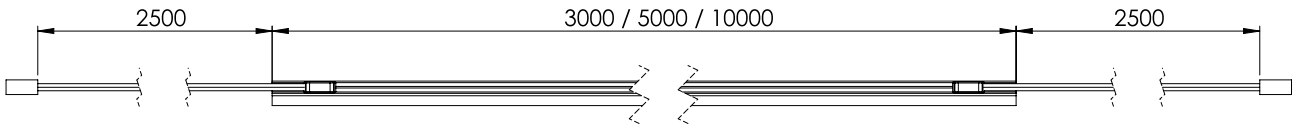
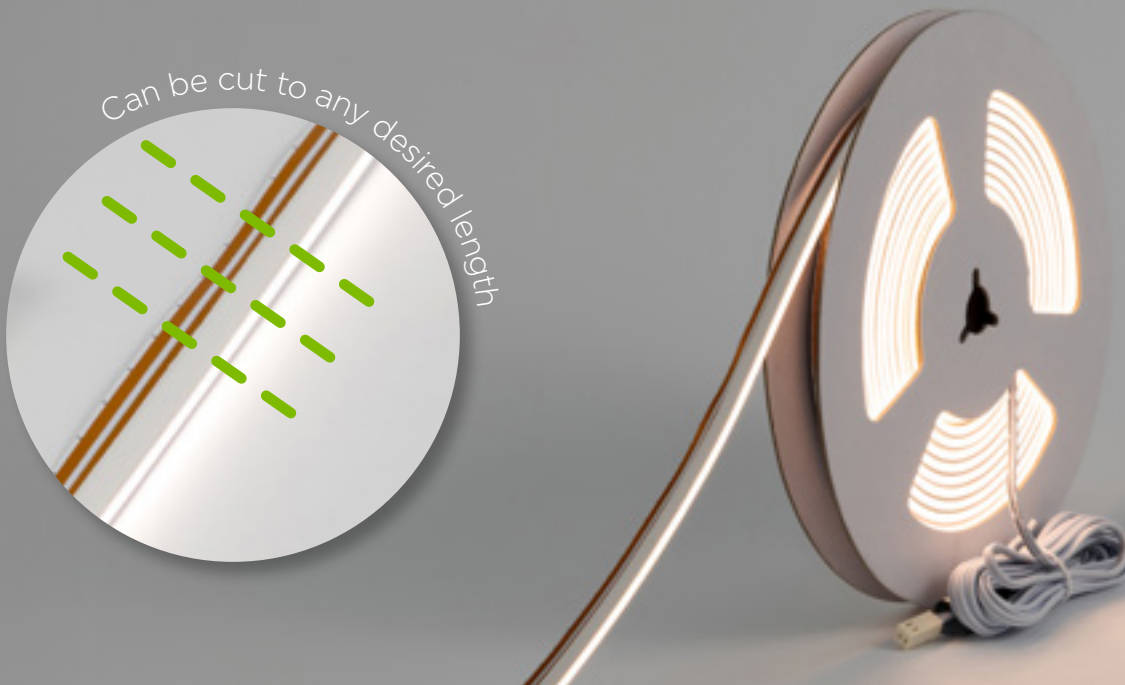

**Ideal for bespoke
routed 4mm channels
widely used in
manufacturing**

4mm

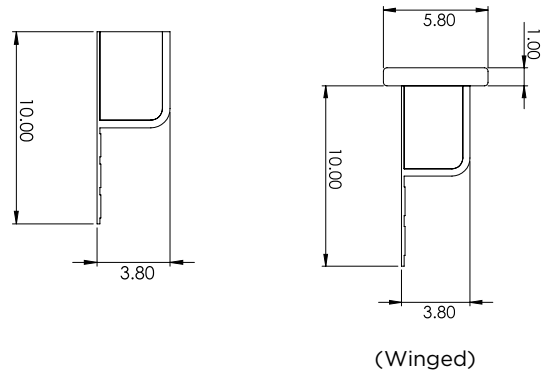

(Winged)

Natural White - 4000K | 512 LED/m

SKU	Length	Dimensions	Wattage	Lumens	Colour	RRP
SE00137	3m	10mm x 3.8mm	6 W/m	508 lm/m	Natural	£67.85
SE00140	5m	10mm x 3.8mm	6 W/m	508 lm/m	Natural	£114.48
SE00161	5m (Winged)	10mm x 3.8 (5.8mm inc wings)	6 W/m	508 lm/m	Natural	£116.40
SE00143	10m	10mm x 3.8mm	6 W/m	508 lm/m	Natural	£226.80

Warm White - 3000K | 512 LED/m

SKU	Length	Dimensions	Wattage	Lumens	Colour	RRP
SE00136	3m	10mm x 3.8mm	6 W/m	508 lm/m	Warm	£67.85
SE00139	5m	10mm x 3.8mm	6 W/m	508 lm/m	Warm	£114.48
SE00160	5m (Winged)	10mm x 3.8 (5.8mm inc wings)	6 W/m	508 lm/m	Warm	£116.40
SE00142	10m	10mm x 3.8mm	6 W/m	508 lm/m	Warm	£226.80

Accessories

SKU	Accessory	Cable length	RRP
SE900980	Razor X 4mm driver connection cable kit	2500mm	£6.72
SE9009	Extension Cable	2500mm	£3.94

Available to order from 19th December 2025



RAZOR X PRO 2MM

Free-Cut Recessed CCT LED Strip

Providing the benefits of the super slim Razor X 2mm but with colour changing technology (CCT). The Razor X Pro 2mm seamlessly transitions from Warm White (2700K) to Cool White (6500K) with colour changing technology.

- CCT: Correlated Colour Temperature.
- Free cut: Can be cut to any desired length.
- Chip on Board (COB): Technology provides seamless light output and efficiency.
- Recessed Installation: Easily recessed with a saw cut or router.
- Bendable: Easily flow around corner recesses.
- Push fit install: No VHB adhesive backing for easy push fit installation.
- Compatibility: Adjust brightness when paired with Sensio controls and drivers.
- Connection: Pre-soldered 2.5m driver connection cables at each end.
- Accessories: Additional driver connection cable (sold separately) to utilise all cut lengths.
- Profiles: Pair with the Edge profile, designed specifically for the Razor X strip.
- Registered design right: 6371778.

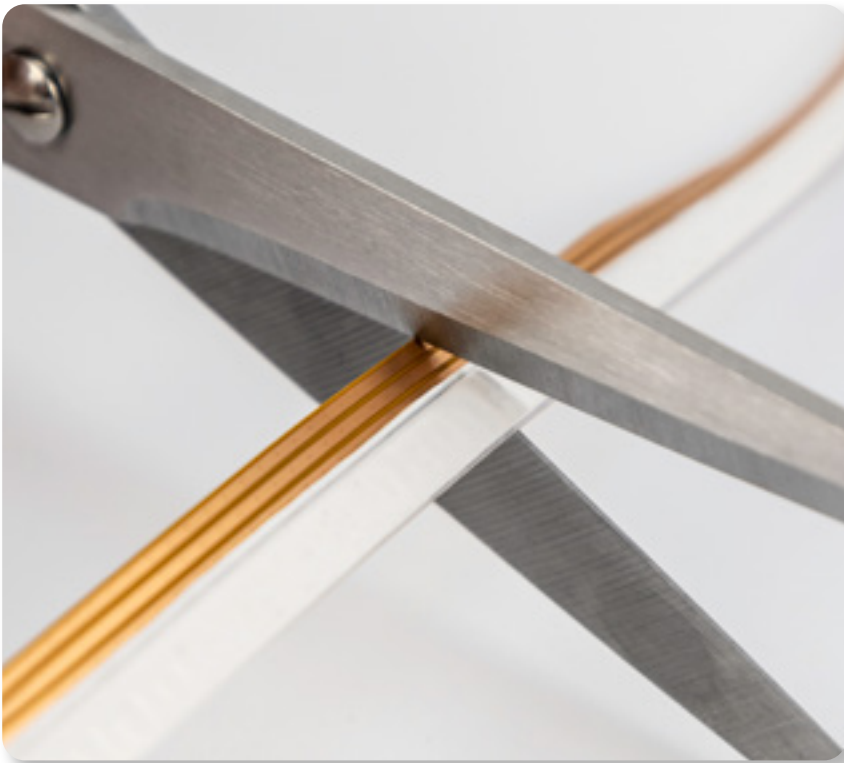

Both the Razor X 2mm and Razor X Pro 2mm install harmoniously with the Edge profile.

Cut the Razor X Pro at any point to achieve the perfect fit.

Ideal for bespoke routed 2mm channels produced with a circular saw.

2mm

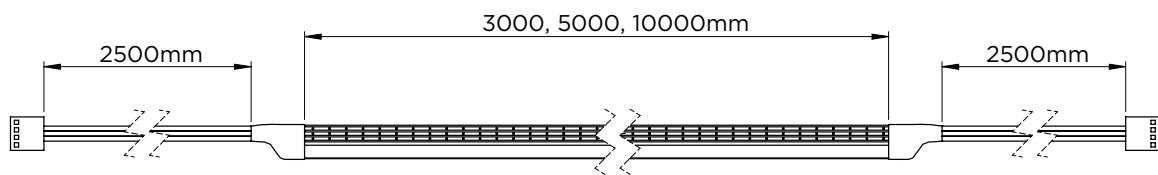
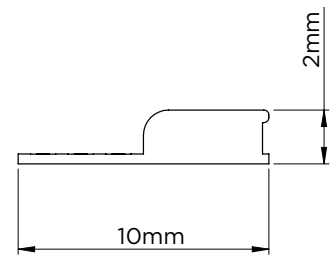

CCT - 2700-6000K | 512 LED/m

SKU	Length	Dimensions	Wattage	Lumens	Colour	RRP
SE21094PO	3m	10mm x 2.15mm	6W/m	508lm/m	CCT	£79.25
SE21095PO	5m	10mm x 2.15mm	6W/m	508lm/m	CCT	£138.56
SE21096PO	10m	10mm x 2.15mm	6W/m	508lm/m	CCT	£265.31

Accessories

SKU	Accessory	Cable length	RRP
SE900990	Razor X Pro - 2500mm Driver Connection Cable Kit	2500mm	£4.94
SE210029AO	Razor X Pro 2mm Interconnecting Cable	1500mm	£3.80
SE90010	CCT Extension Lead	2500mm	£5.46

RAZOR X PRO 4MM

Free-Cut Recessed LED Strip

With all the benefits of flexible Razor X but with colour changing technology (CCT). The Razor X Pro 4mm seamlessly transitions from Warm White (2700K) to Cool White (6000K) with colour changing technology.

- CCT: Correlated Colour Temperature.
- Free cut: Can be cut to any desired length.
- Chip on Board (COB): Technology provides seamless light output and efficiency.
- Recessed Installation: For anyone with routing capabilities, either CNC machine or hand routing.
- Bendable: Easily flow around corner recesses.
- Push fit install: No VHB adhesive backing for easy push fit installation.
- Flexible driver connection cable: For either side or back cable placement.
- Compatibility: Adjust brightness when paired with Sensio controls and drivers.
- Connection: Pre-soldered 2.5m driver connection cables at each end.
- Accessories: Additional driver connection cable (sold separately) to utilise all cut lengths.
- Registered design right: 6371778.





**“Designed with
manufacturers in mind.”**

Product Design Team,
Sensio.

Cut the Razor X Pro at any point to achieve the perfect fit.

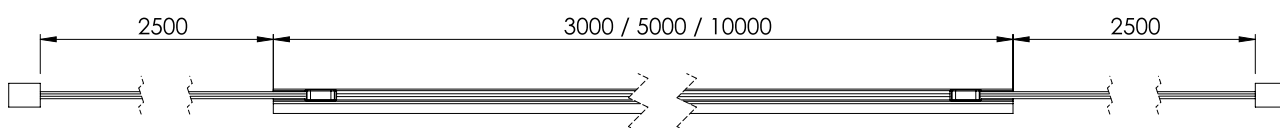

**Ideal for bespoke routed 4mm channels
widely used in manufacturing**

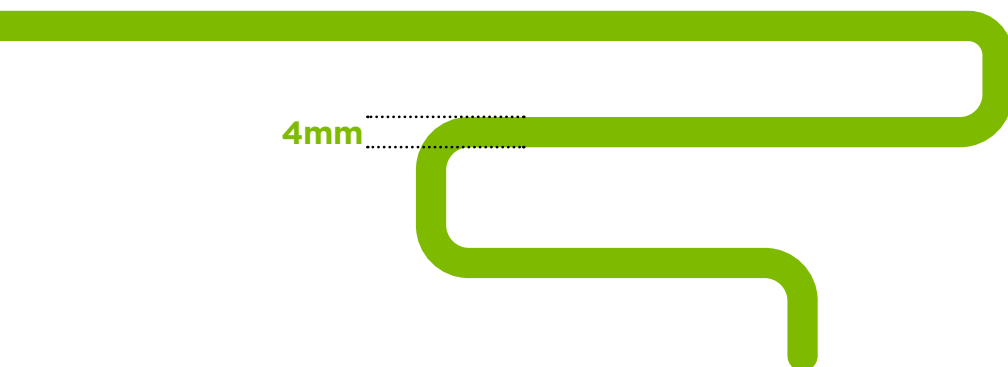

4mm

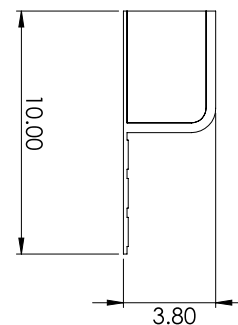

CCT - 2700 - 6000K | 512 LED/m

SKU	Length	Dimensions	Wattage	Lumens	Colour	RRP
SE00138	3m	10mm x 3.8mm	6 W/m	508 lm/m	CCT	£81.00
SE00141	5m	10mm x 3.8mm	6 W/m	508 lm/m	CCT	£139.50
SE00144	10m	10mm x 3.8mm	6 W/m	508 lm/m	CCT	£267.00

Accessories

SKU	Details	Cable length	RRP
SE00146	Razor X Pro 4mm Driver connection cable kit	2500mm	£6.20
SE90010	CCT Extension Lead	2500mm	£5.46

Available to order from 19th December 2025

POLAR X

Free-Cut Flexible LED Strip



Natural white

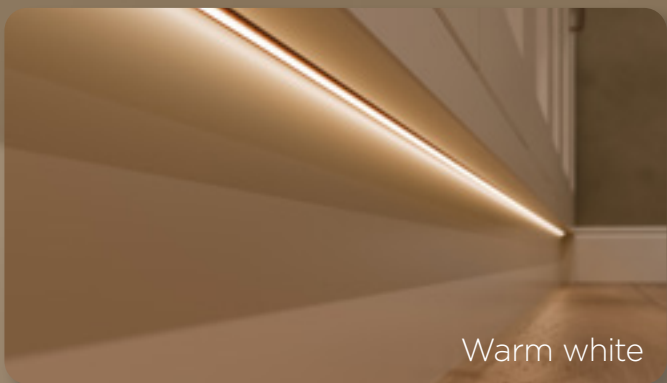

Warm white

Polar X, the next gen of our ever popular Polar COB LED strips. The Polar X is cuttable at any length, delivering precision for installation leaving no spots in the dark. Providing a completely diffused line of light with no visible LED dots, eliminating the need for a profile or cover.

- Single Colour: Choose Natural white light (4000K) or Warm light (3000K).
- Free cut: Can be cut to any desired length.
- Chip on Board (COB): Technology provides seamless light output and efficiency.
- No Voltage Drop: 24V allows long runs of light without any fade, even across longer runs of 25m.
- VHB (Very High Bond): adhesive tape backing for secure installation.
- Compatibility: Adjust brightness when paired with Sensio controls and drivers.
- Connection: Pre-soldered 2.5m driver connection cables at each end.
- Accessories: Additional driver connection cable (sold separately) to utilise all cut lengths.
- Registered design right: 6366472.



***“Your favourite COB strip now available in increased lengths to bring any lighting design to life.*”**

Product Design Team,
Sensio.

Cut the Polar X anywhere to get the perfect trim for your installation.

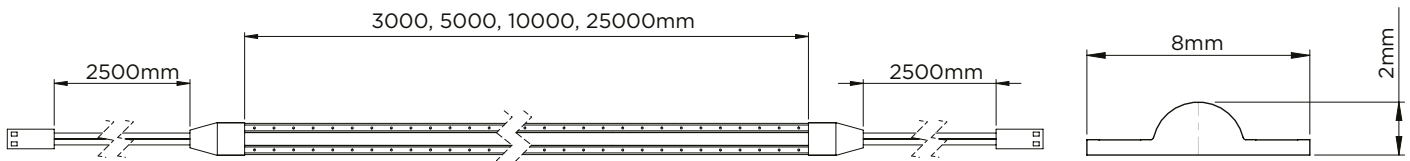

Natural White - 4000K | 512 LED/m

SKU	Length	Dimensions	Wattage	Lumens	Colour	RRP
SE040019NDNO	3m	8mm x 2mm	6W/m	600lm/m	Natural	£67.08
SE20055N0	5m	8mm x 2mm	6W/m	600lm/m	Natural	£114.48
SE040039NDNO	10m	8mm x 2mm	6W/m	600lm/m	Natural	£218.23
SE040049NDNO	25m NEW	8mm x 2mm	6W/m	600lm/m	Natural	£503.51

Warm White - 3000K | 512 LED/m

SKU	Length	Dimensions	Voltage	Lumens	Colour	RRP
SE040019NDWO	3m	8mm x 2mm	6W/m	600lm/m	Warm	£67.08
SE20055W0	5m	8mm x 2mm	6W/m	600lm/m	Warm	£114.48
SE040039NDWO	10m	8mm x 2mm	6W/m	600lm/m	Warm	£218.23
SE040049NDWO	25m NEW	8mm x 2mm	6W/m	600lm/m	Warm	£503.51

Accessories - Compatible with the existing range of Polar cables & accessories

Code	Description	RRP
SE103990	2500mm Polar Driver Connection Lead	£4.03
SE105790	1500m Polar Interconnecting Lead	£2.70
SE105990	50mm Polar Corner Connector	£2.04
SE112990	Polar Joining Clip	£2.98
SE9009	2500mm Extension Cable	£3.94

New LED strips available to order from 9th January 2026

POLAR X PRO

Free-Cut Flexible LED Strip

Providing all the benefits of the Polar X, with added colour changing technology, the Polar X Pro offers a seamless transition between cool and warm colour temperatures to suite any space and design.



- CCT: Correlated Colour Temperature.
- Free cut: Can be cut to any desired length.
- Chip on Board (COB): Technology provides seamless light output and efficiency.
- No Voltage Drop: 24V allows long runs of light without any fade, even across longer runs of 25m.
- VHB (Very High Bond): adhesive tape backing for secure installation.
- Compatibility: Adjust brightness when paired with Sensio controls and drivers.
- Connection: Pre-soldered 2.5m driver connection cables at each end.
- Accessories: Additional driver connection cable (sold separately) to utilise all cut lengths.
- Registered design right: 6366473.



Cool white



Natural white

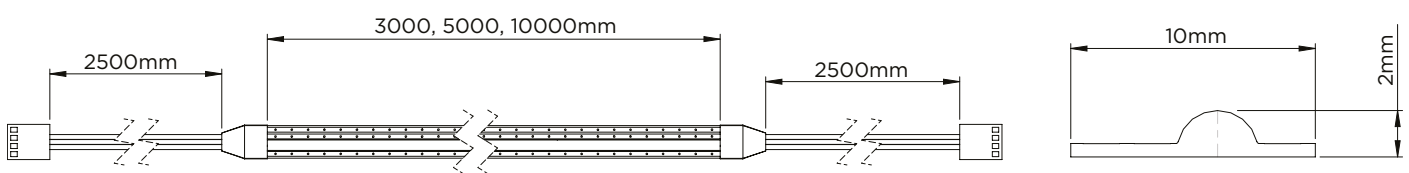

CCT - 2700 - 6500K | 512 LED/m

SKU	Length	Dimensions	Wattage	Lumens	Colour	RRP
SE040019NDPO	3m	10mm x 2mm	6W/m	580lm/m	CCT	£79.46
SE20055PO	5m	10mm x 2mm	6W/m	580lm/m	CCT	£138.50
SE040039NDPO	10m	10mm x 2mm	6W/m	580lm/m	CCT	£265.31

Accessories - Compatible with the existing range of Polar Pro cables & accessories

SKU	Description	RRP
SE900890	2500mm Polar Pro Driver Connection Lead	£5.64
SE901790	1500mm Polar Pro Interconnecting Lead	£4.46
SE902990	50mm Polar Pro Corner Connector	£3.58
SE903990	Polar Pro Joining Clip	£2.81
SE90010	2500mm CCT Extension Lead	£5.46

PRIMO X

Free-Cut Economic LED Strip

A versatile economic flexible strip now with double the diode count per metre to offer seamless light output when diffused.

- Single Colour: Choose Cool white light (6000K), Natural white light (4000K) or Warm light (2700K).
- An evolution from our ever popular Primo 2, the Primo X is a versatile economic flexible strip now with double the diode count per metre, to offer seamless light output when diffused.
- Free cut: Can be cut to any desired length either side of the diode.
- Compatibility: Adjust brightness when paired with Sensio controls and drivers.
- Connection: Pre-soldered 2.5m driver connection cables at each end.
- Accessories: Additional driver connection cable (sold separately) to utilise all cut lengths.



Can be cut to any desired length



Primo 2
LED Strip



Increased diode count
vs Primo 2 model providing
better light diffusion



***“You asked we listened.
Upgraded diode count for an seamless
illumination from an economic strip.”***

Product Design Team, Sensio.

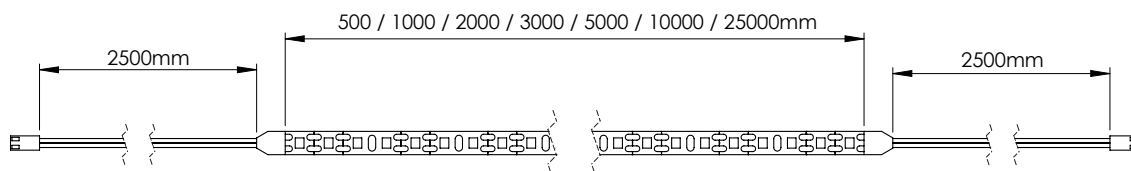

Cool White - 6000K | 120 LED/m

SKU	Length	Dimensions	Wattage	Lumens	Colour	RRP
SE00191	500mm	8mm x 1.5mm	3.6 W/m	440 lm/m	Cool	£7.80
SE00194	1m	8mm x 1.5mm	3.6 W/m	440 lm/m	Cool	£15.59
SE00197	2m	8mm x 1.5mm	3.6 W/m	440 lm/m	Cool	£24.17
SE00245	3m	8mm x 1.5mm	3.6 W/m	440 lm/m	Cool	£31.09
SE00246	5m	8mm x 1.5mm	3.6 W/m	440 lm/m	Cool	£43.67
SE00247	10m	8mm x 1.5mm	3.6 W/m	440 lm/m	Cool	£84.79

Natural White - 4000K | 120 LED/m

SKU	Length	Dimensions	Wattage	Lumens	Colour	RRP
SE00193	500mm	8mm x 1.5mm	3.6 W/m	440 lm/m	Natural	£7.80
SE00196	1m	8mm x 1.5mm	3.6 W/m	440 lm/m	Natural	£15.59
SE00199	2m	8mm x 1.5mm	3.6 W/m	440 lm/m	Natural	£24.17
SE00241	3m	8mm x 1.5mm	3.6 W/m	440 lm/m	Natural	£31.09
SE00242	5m	8mm x 1.5mm	3.6 W/m	440 lm/m	Natural	£43.67
SE00243	10m	8mm x 1.5mm	3.6 W/m	440 lm/m	Natural	£84.79
SE00244	25m	8mm x 1.5mm	3.6 W/m	440 lm/m	Natural	£201.34

Warm White - 2700K | 120 LED/m

SKU	Length	Dimensions	Wattage	Lumens	Colour	RRP
SE00192	500mm	8mm x 1.5mm	3.6 W/m	440 lm/m	Warm	£7.80
SE00195	1m	8mm x 1.5mm	3.6 W/m	440 lm/m	Warm	£15.59
SE00198	2m	8mm x 1.5mm	3.6 W/m	440 lm/m	Warm	£24.17
SE00237	3m	8mm x 1.5mm	3.6 W/m	440 lm/m	Warm	£31.09
SE00238	5m	8mm x 1.5mm	3.6 W/m	440 lm/m	Warm	£43.67
SE00239	10m	8mm x 1.5mm	3.6 W/m	440 lm/m	Warm	£84.79
SE00240	25m	8mm x 1.5mm	3.6 W/m	440 lm/m	Warm	£201.34

Accessories

SKU	Details	RRP
SE00175	Universal 2500mm Driver Connection Lead (2-pin)	£3.60
SE00177	Universal 1500mm Interconnecting Lead	£3.65
SE00179	Universal Corner Connector	£2.61
SE00178	Universal Joining Clip	£2.06
SE00180	Universal T-Junction Connector	£2.61
SE9009	2500mm Extension lead	£3.94

Full collection available from 2nd January 2026

FLEXIBLE LED PANELS

Sheets of light

Flexible panels of uniform illumination. Our new range of sheet lights, Pixel & Pixel Pro have been developed to deliver even illumination over any surface. Pair with natural stone to create a statement installation.



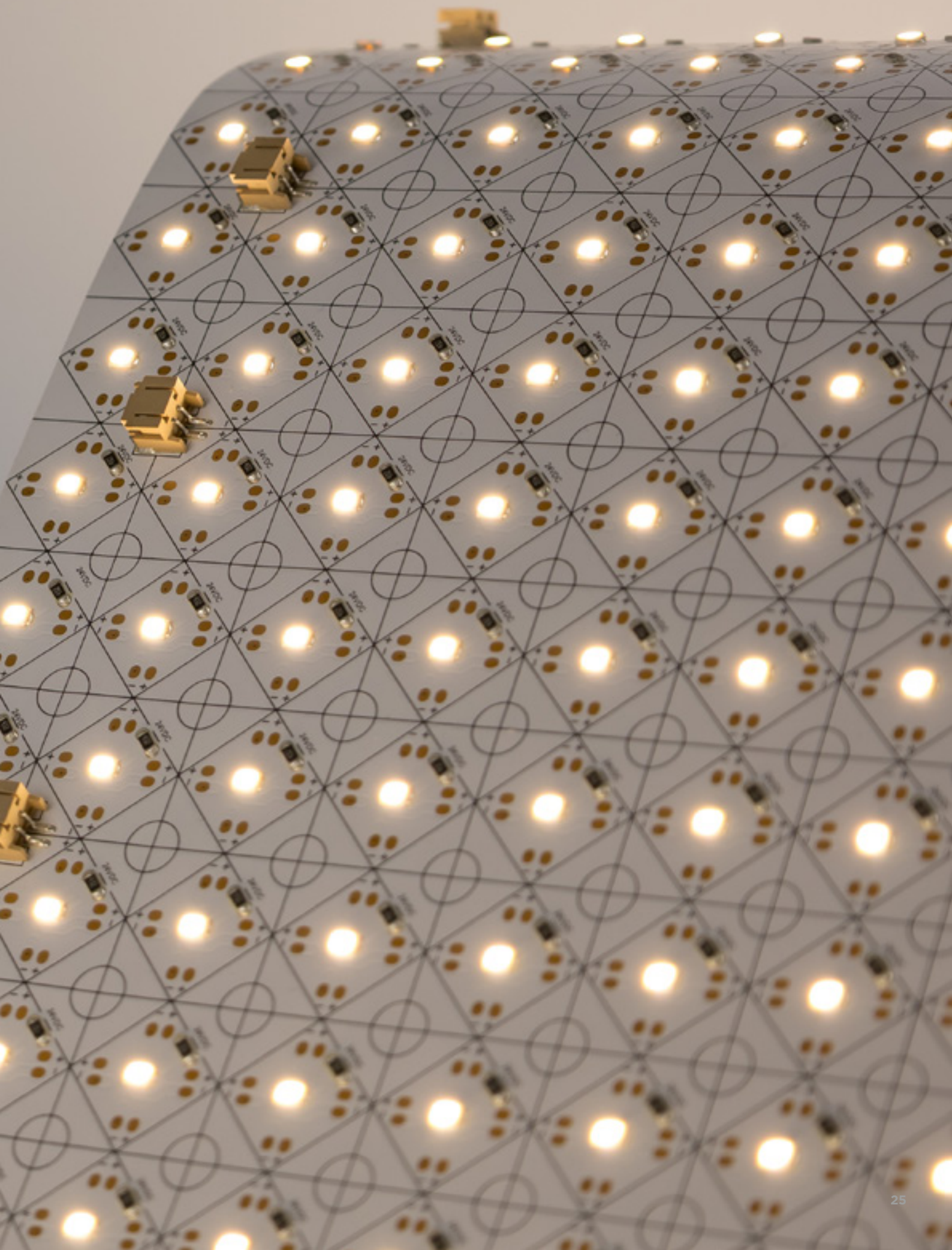

PIXEL

The Pixel Panel is a flexible LED sheet designed for bespoke installation and large-scale applications. Ideal for luxury interiors, including under marble worktops, architectural features, backlit signage and displays, and commercial environments where uniform lighting is essential.

- Single Colour: Natural white light (4000K).
- Bendable: Flexible material for curved or corners for bespoke installations.
- Free cut: This can be cut in all directions.
- Connection: Supplied with 2.5m driver connection cables for easy set up.
- Compatibility: Adjust brightness when paired with Sensio controls and drivers.
- Slim Connectors: 5.75mm connector blocks, positioned around the sheet for versatile connection.
- Accessories: Connect multiple panels together using interconnecting leads (sold separately) to achieve larger illuminated areas.

Pixel in-situ



Used to link two Pixel Panels together for continuous illumination across larger surfaces, ensuring a seamless lighting connection between panels.



A 2500mm driver connection cable designed for use with the Pixel Panel.

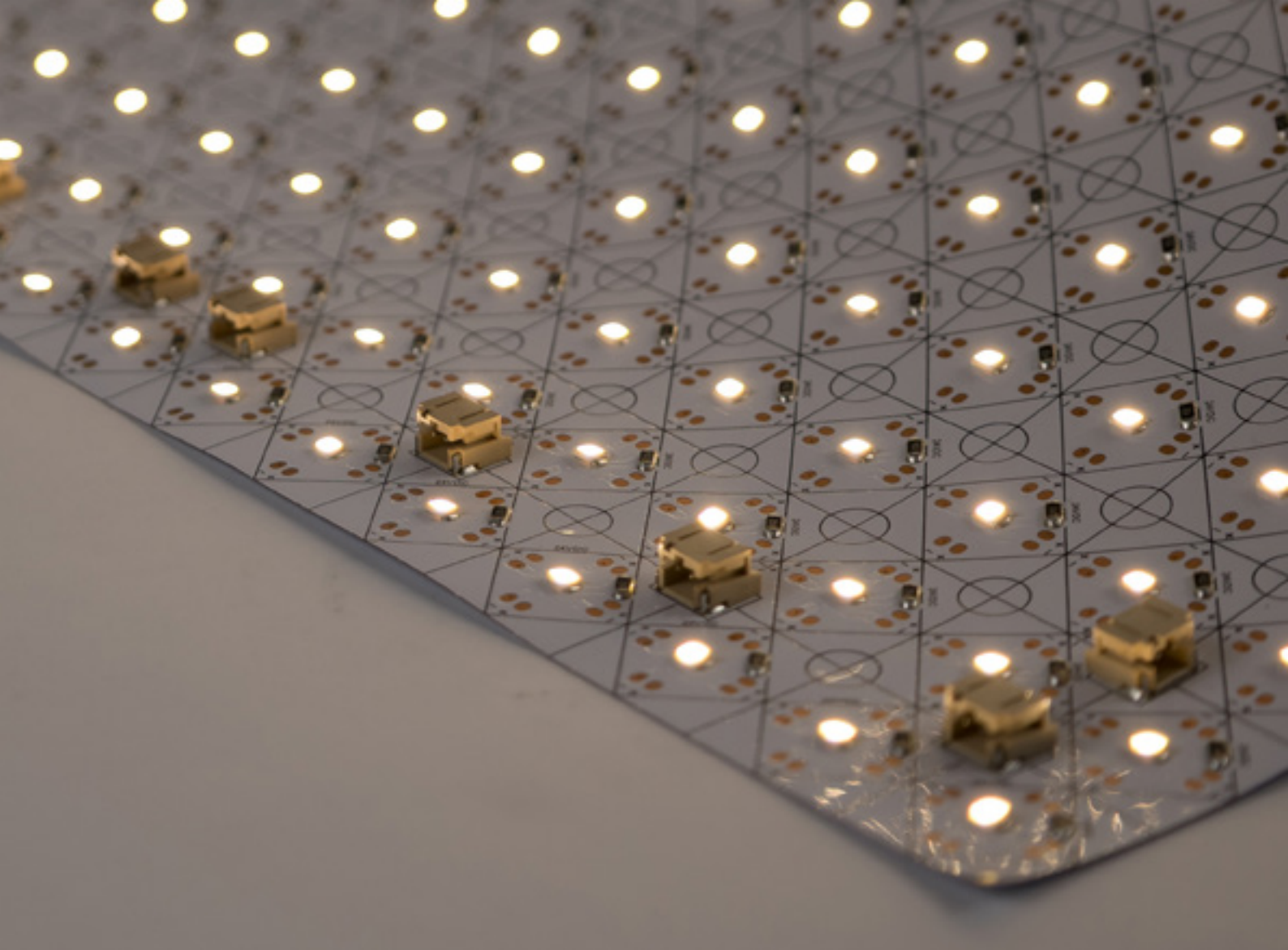

“

“Designed for architects & designers to enhance luxury interiors.”

Product Design Team, Sensio.



Natural White - 4000K

SKU	Dimensions	Wattage	Lumens	RRP
SE00181	300mm x 600mm x 5.75mm	15W	1400 lm/pcs	£71.74
SE00182	300mm x 600mm x 5.75mm	20W	1800 lm/pcs	£71.74
SE00183	300mm x 600mm x 5.75mm	30W	2000 lm/pcs	£71.74

Accessories

SKU	Details	RRP
SE00184	Pixel - 2500mm Driver Connection Lead	£4.51
SE00185	Pixel - 45mm Interconnecting Lead	£2.66
SE9009	2500mm Extension lead	£3.94

Available to order from 12th December 2025

PIXEL PRO

With all the benefits of the Pixel, the Pro version includes colour changing technology (CCT). The Pixel Pro seamlessly transitions from Warm White (2000K) to Cool White (6000K) with colour changing technology.

- CCT: Correlated Colour Temperature.
- Bendable: Flexible material for curves or corners for bespoke installations.
- Free cut: This can be cut in all directions.
- Connection: Supplied with 2.5m driver connection cables for easy set up.
- Compatibility: Adjust brightness when paired with Sensio controls and drivers.
- Slim Connectors: 5.85mm connector blocks, positioned around the sheet for versatile connection.
- Accessories: Connect multiple panels together using interconnecting leads (sold separately) to achieve larger illuminated areas.



“Curves and corners are no match for the Pixel, with fully flexible and free cut technology.”

Product Design Team,
Sensio.

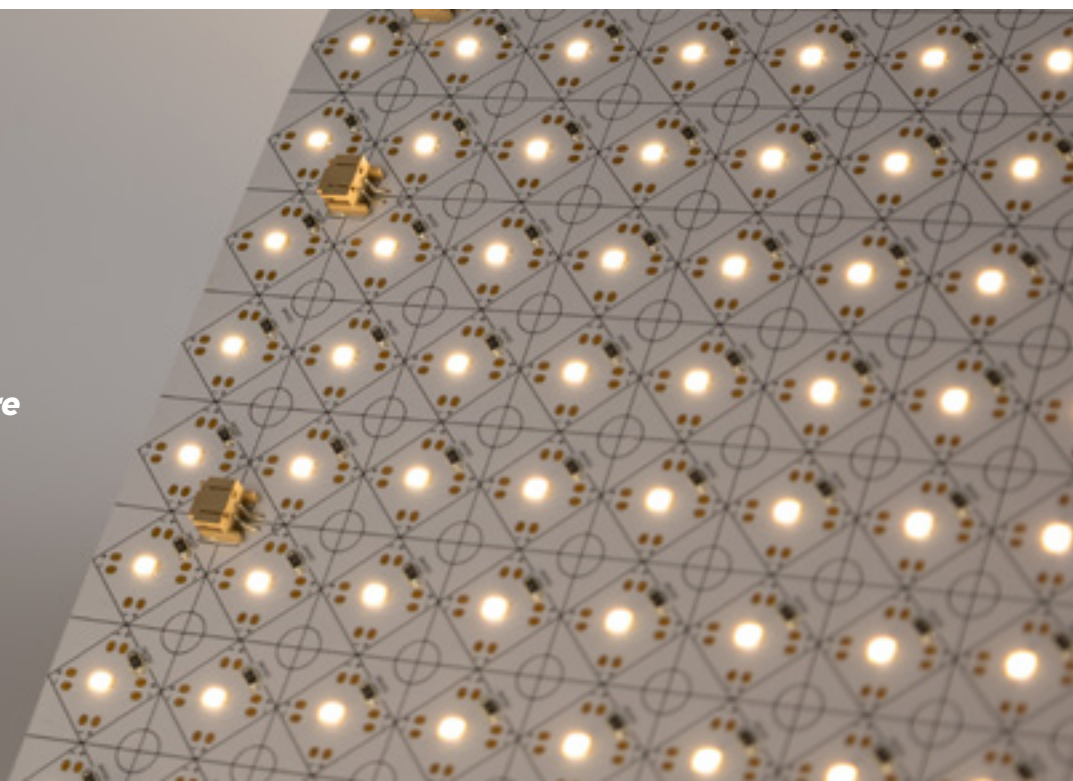

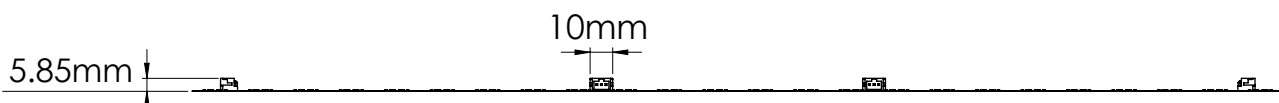

CCT - 2700K - 6500K |

SKU	Dimensions	Wattage	Lumens	RRP
SE00264	240mm x 480mm x 5.85mm	15W	1400 lm/pcs	£72.41
SE00265	240mm x 480mm x 5.85mm	20W	1800 lm/pcs	£72.41
SE00266	240mm x 480mm x 5.85mm	30W	2000 lm/pcs	£72.41

Accessories

SKU	Details	RRP
SE00267	Pixel Pro - 2500mm Driver Connection Lead	£5.72
SE00268	Pixel Pro - 45mm Interconnecting Lead	£3.43
SE90010	2500mm CCT Extension Lead	£5.46

Available to order from 12th December 2025

AFFINITY

GAME CHANGING LIGHTING

Designed with installers in mind.

First to market innovation, changing the game on how installers use lighting. Introducing the Affinity track system, designed to simplify and future proof installations with its magnetic technology and interchangeable accessories.





Magnetic Track

A magnetic track lighting system designed to make custom lighting effortless. Simply stick the track to your desired surface and customise your setup, from spotlights to LED strips using interchangeable accessories and controls. The system requires only one power cable (sold separately) and any Titan+ Driver (depending on wattage), to run multiple lights, reducing the need to chase each light.

- Free cut: Can be cut to any desired length.
- VHB (Very High Bond): adhesive tape backing for secure installation.
- Patent protected: P46352W01.



Under Cabinet Lighting (Compatible with Affinity Magnetic Track)

A TrioTone® spot light designed to secure to the Affinity track with magnetic backing for complete customisation.

- TrioTone®: Select between Warm (3000K), Natural (4000K), or Cool White (5000K).
- Patent protected.

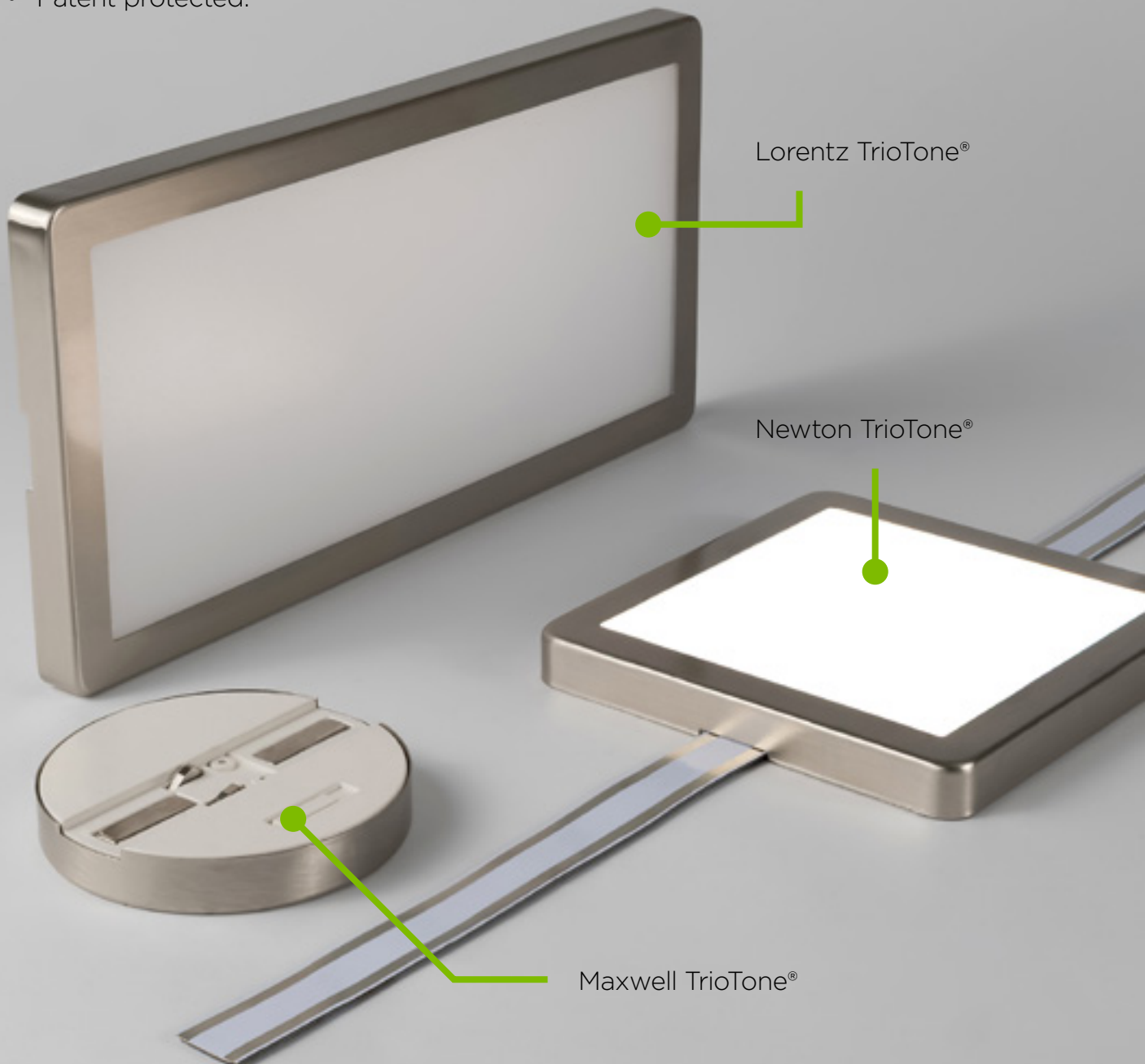

“

“Flexible lighting at your fingertips. Simply click the magnetic lights into place and move them whenever you like, no need to adjust each one.”

Product Design Team, Sensio.

'CLICK!'

Attached anywhere on the track to best illuminate your space.



USB / USB-C Charging Port

- Secures to the Affinity Track with the magnet on the back for complete customisation.
- Patent protected.

IR Sensor

Secures to the Affinity Track with the magnet on the back for complete customisation. Activate lighting by swiping hand in front of sensor or dim lighting by holding hand in front of sensor.

- Will only work when using the Titan+ driver with the Affinity system. (IR sensor can't be used in conjunction with Smart App, Voice or Kinetic control).
- Patent protected.

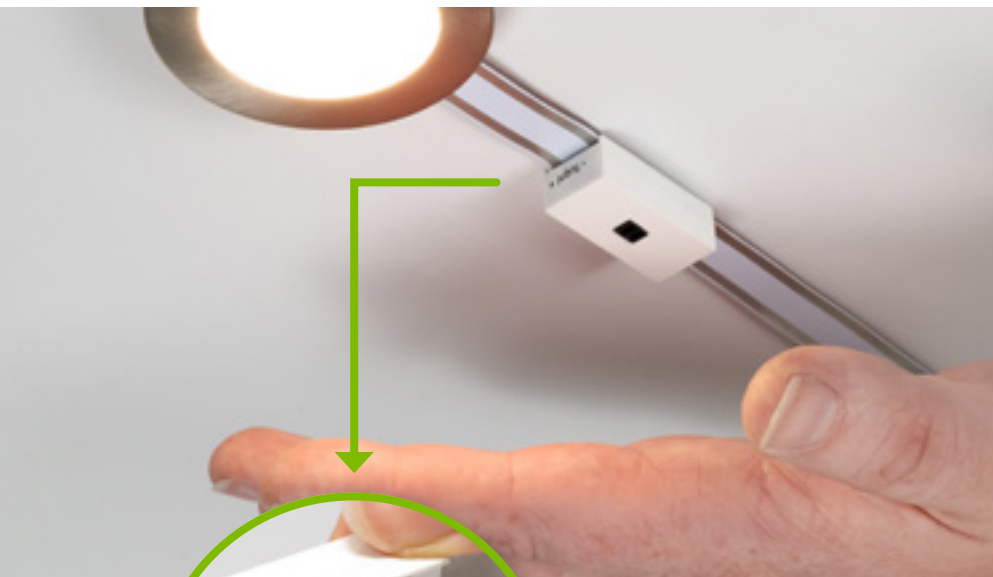

2 cut tracks required for the IR Sensor to function.

Faraday X

A single colour flexible strip designed to secure to the Affinity track with magnetic backing for complete customisation.

- Single Colour: Choose natural white light (4000K) or warm white light (3000K).
- Free cut: Can be cut to any desired length.
- Chip on Board (COB): Technology provides seamless light output and efficiency.
- Connection: Illuminate the strip with the strip connector (sold separately).
- Reel comes with 1 x flexible strip connector.
- Patent protected.



Affinity Magnetic Track

SKU	Length	Dimensions	RRP
SE00273	3m	14mm x 1mm	£39.44
SE00034	5m	14mm x 1mm	£59.78

Under Cabinet Spot Lights - TrioTone® (3000K, 4000K, 5000K)

SKU	Details	Dimensions	Wattage	Lumens	Colour	RRP
SE00050	Maxwell TrioTone®	66mm x 66mm x 11mm	2.5W	161 lm	Cool Natural Warm	£13.65
SE00049	Newton TrioTone®	100mm x 100mm x 11mm	3.6W	227 lm	Cool Natural Warm	£18.12
SE00051	Lorentz TrioTone®	100mm x 200mm x 11mm	4.8W	240-280 lm	Cool Natural Warm	£25.06

Faraday X LED Strip - 320 LED/m Natural White (4000K)

SKU	Length	Dimensions	Wattage	Lumens	Colour	RRP
SE00210	3m	14mm x 5mm	6 W/m	535 lm/m	Natural	£55.32

Faraday X LED Strip - 320 LED/m Warm White (3000K)

SKU	Length	Dimensions	Wattage	Lumens	Colour	RRP
SE00209	3m	14mm x 5mm	6 W/m	535 lm/m	Warm	£55.32

Accessories

SKU	Details	Dimensions	RRP
SE00047	IR Sensor	35mm x 16.5mm x 11mm	£10.18
SE00208	USB / USB-C 1W Charging Port	50mm x 20mm x 23mm	£15.14
SE00037	2500mm Driver Connection Lead	2525mm x 20mm x 8mm	£6.71
SE00039	Joining Connector	30mm x 16.5mm x 7mm	£5.47
SE00041	Corner Connector	30mm x 30mm x 7mm	£5.96
SE00043	T-Junction Connector	43.5mm x 30mm x 7mm	£7.45
SE00211	Flexible Strip Connector	35mm x 16.5mm x 7.5mm	£5.47
SE00035	Track Cover	5000mm x 16.5mm x 3mm	£31.01

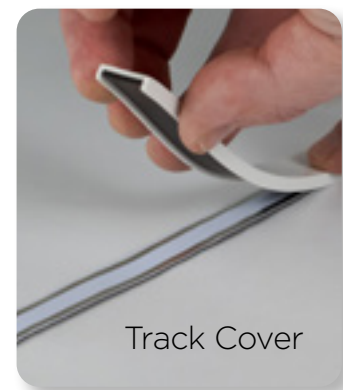

Available to order from 5th March 2026

AFFINITY ACCESSORIES

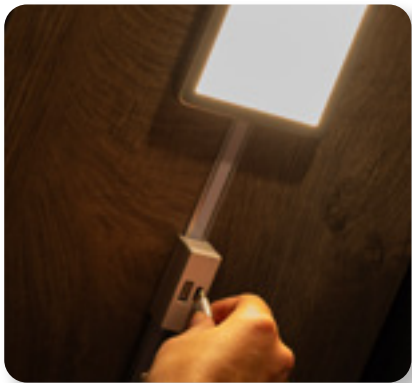

USB/ USB-C
Charging Port

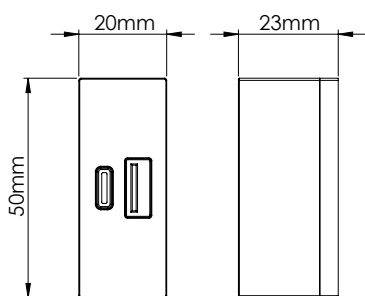

IR Sensor

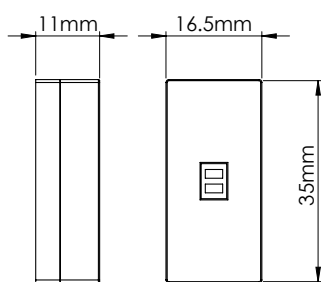

Faraday X

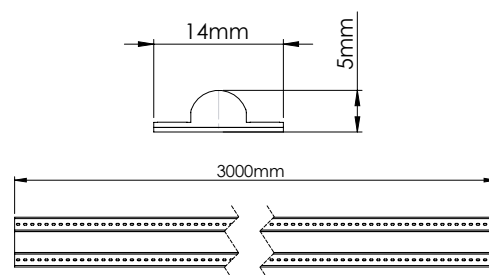

Driver Lead

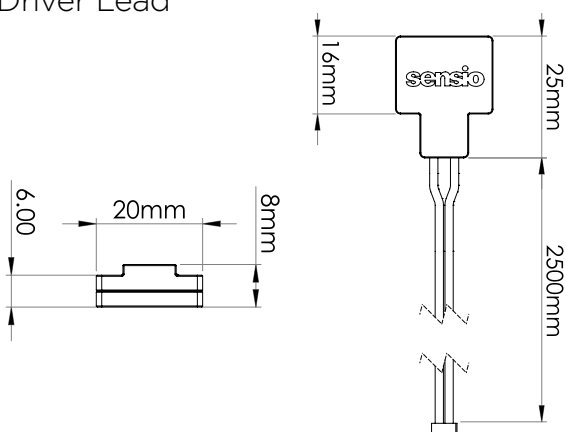

Affinity Joining Accessories

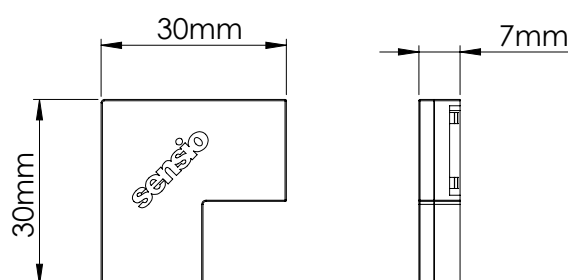

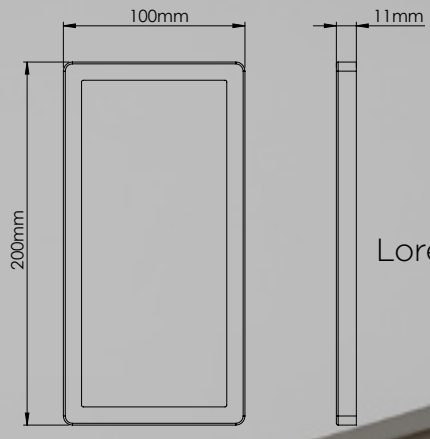

Lorentz TrioTone®

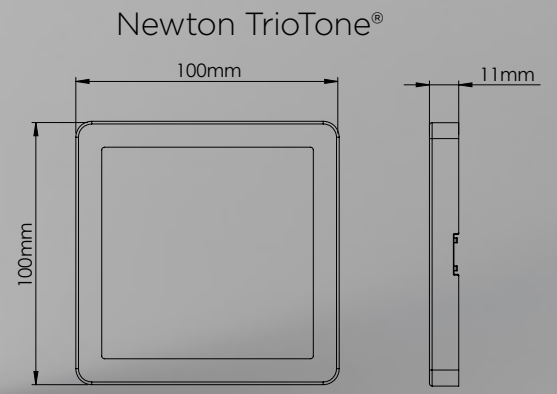
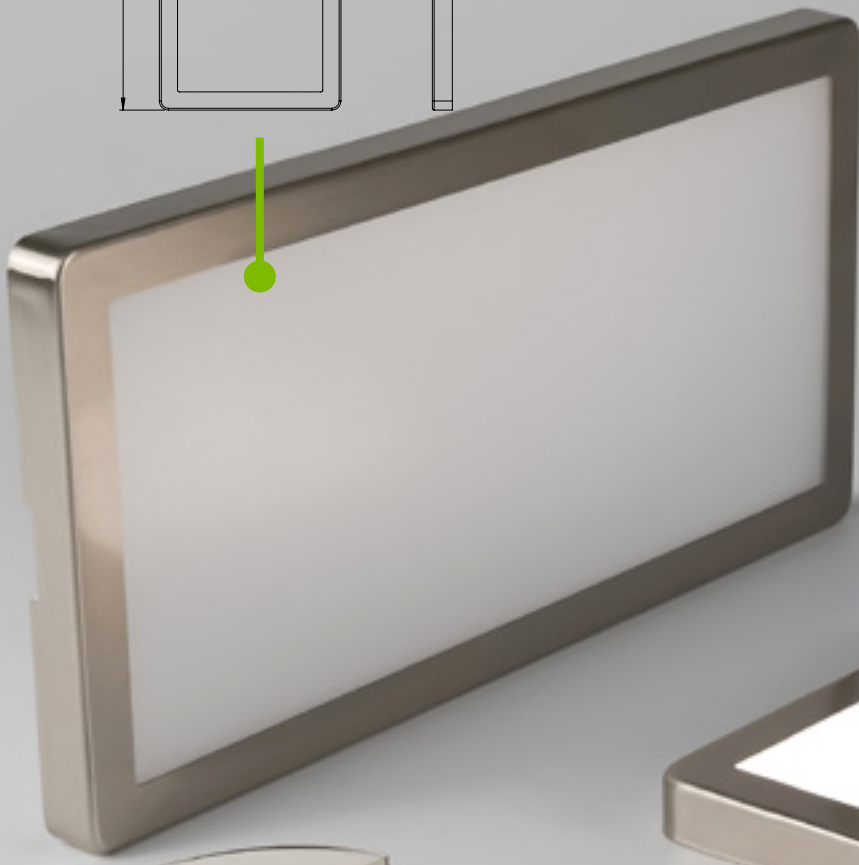

Newton TrioTone®



Maxwell TrioTone®

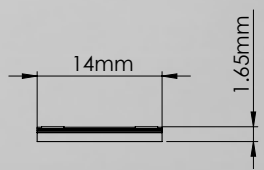
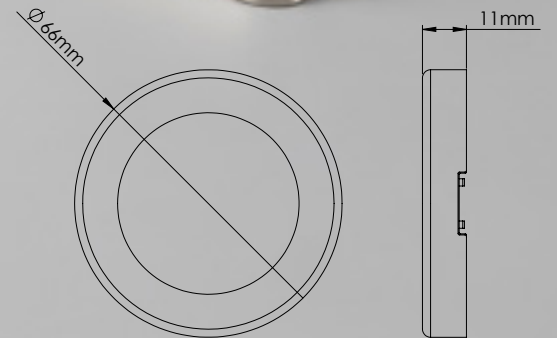

Affinity Magnetic Track

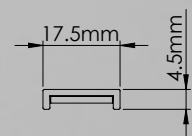
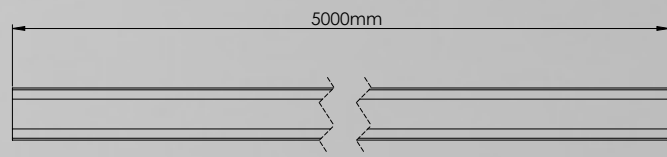

Affinity Magnetic Track Cover

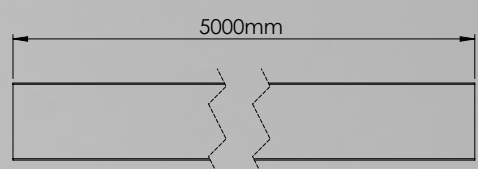



INTEGRATED PROFILES

Not just a simple plastic cover

Each profile has been enhanced with the latest technological advances to not only keep up with trends but to make installation quicker, easier and more seamless.



VERSA SURFACE MOUNTED PROFILE

Premium aluminium profile, designed for surface-mounted installations, offering a high-end finish for any space. Engineered to work seamlessly with Sensio's plug-in sensor modules, available in IR, PIR, or Touch dimmer options (sold separately).

- Push-fit diffuser: Plastic diffuser ensures uninterrupted, even illumination across long runs.
- Universal Strip Compatibility: Suitable for all Sensio flexible LED strips.
- Accessories: Supplied with 4 x mounting brackets and 4 x end caps.
- Full length diffuser: which can be easily trimmed to accommodate a Versa Sensor when required.

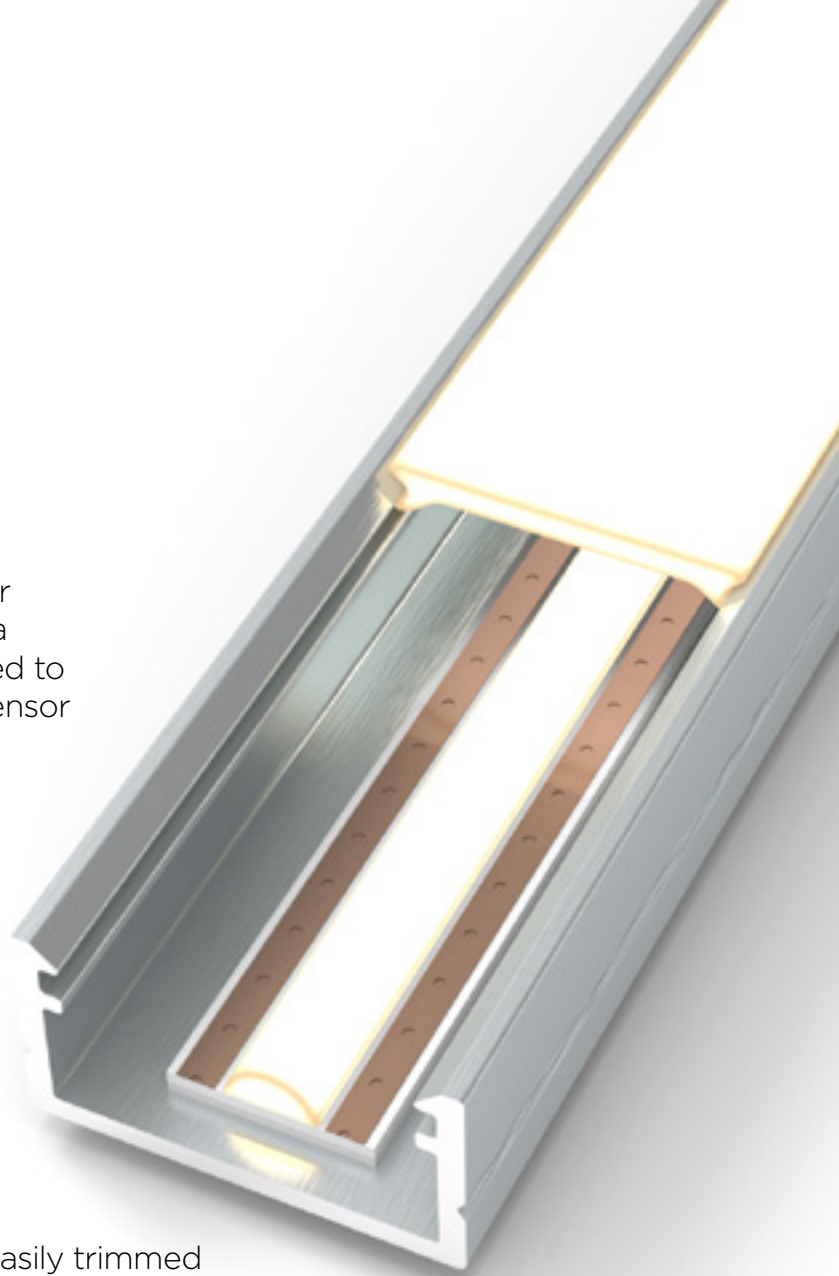

“Reducing complexity with plug in sensor modules to save time on site.”

Product Design Team,
Sensio.

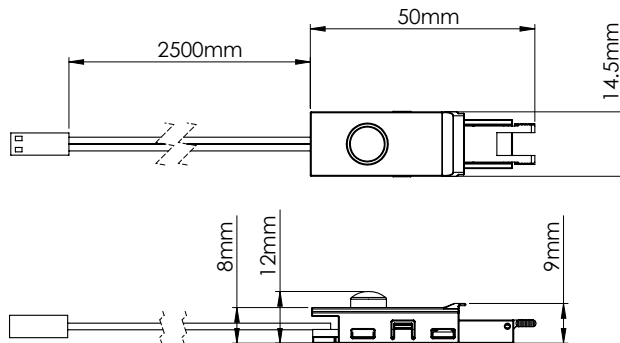
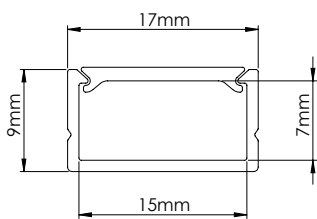

Versa - Surface mounted profile

SKU	Details	Dimensions	RRP
SE00299	Versa - Surface	2500mm x 17mm x 9mm	£22.56
SE00312	Versa - IR Sensor	14.5mm x 9mm x 50mm	£8.60
SE00311	Versa - PIR Sensor	14.5mm x 12mm x 50mm	£9.66
SE00313	Versa - Touch Sensor	14.5mm x 9mm x 50mm	£8.08

Available to order from 5th March 2026

VERSA RECESSED PROFILE

Premium aluminium profile, designed to be recessed for a flush finish within furniture or interiors. Engineered to work seamlessly with Sensio's plug-in sensor modules, available in IR, PIR, or Touch dimmer options.

- Push-fit diffuser: Plastic diffuser ensures uninterrupted, even illumination across long runs.
- Universal Strip
Compatibility: Suitable for all Sensio flexible LED strips.
- Accessories: Supplied with 4 x end caps.
- Full length diffuser: which can be easily trimmed to accommodate a Versa Sensor when required.

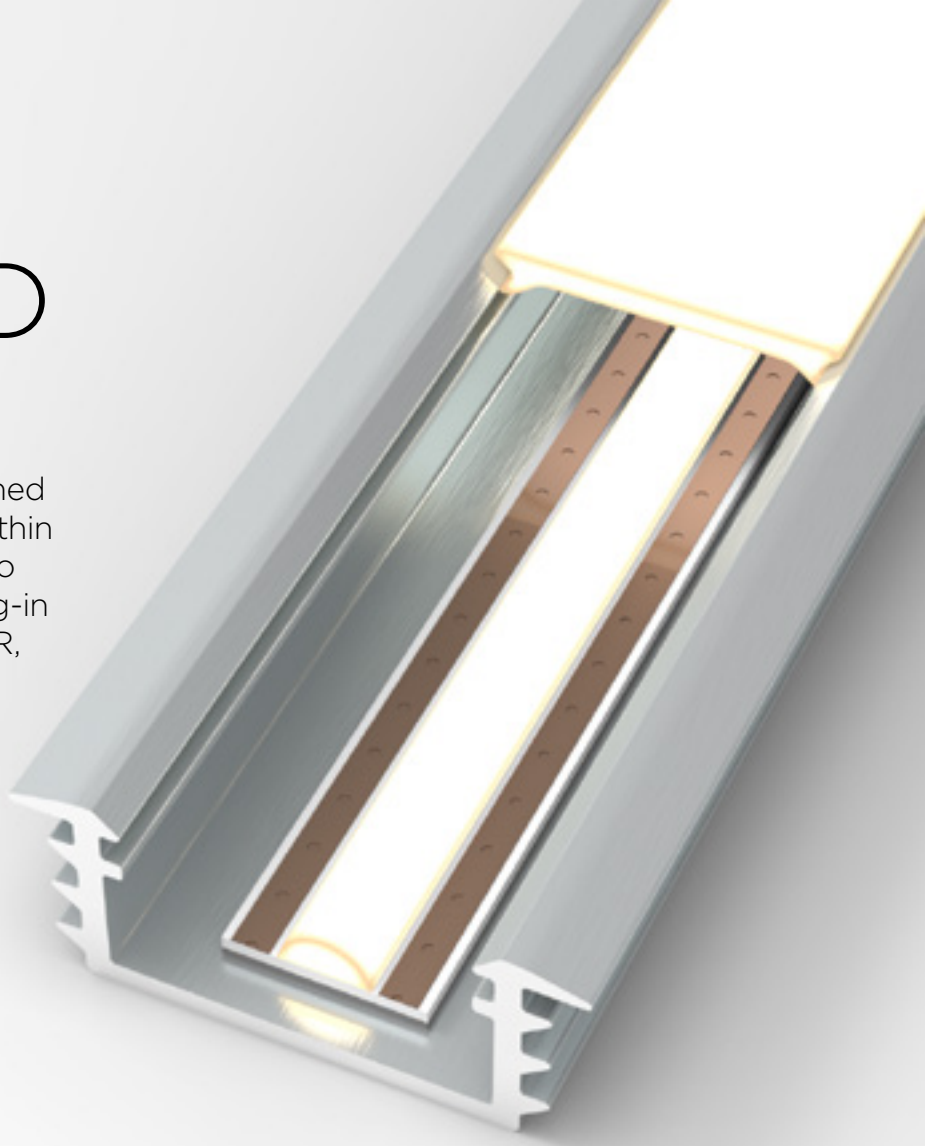

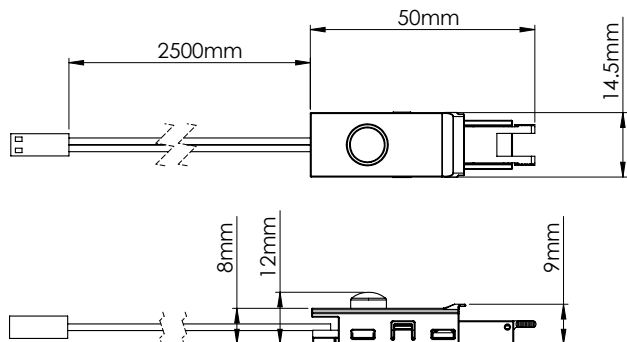
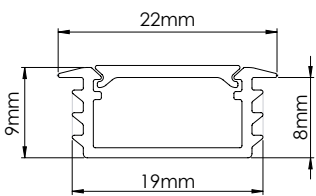
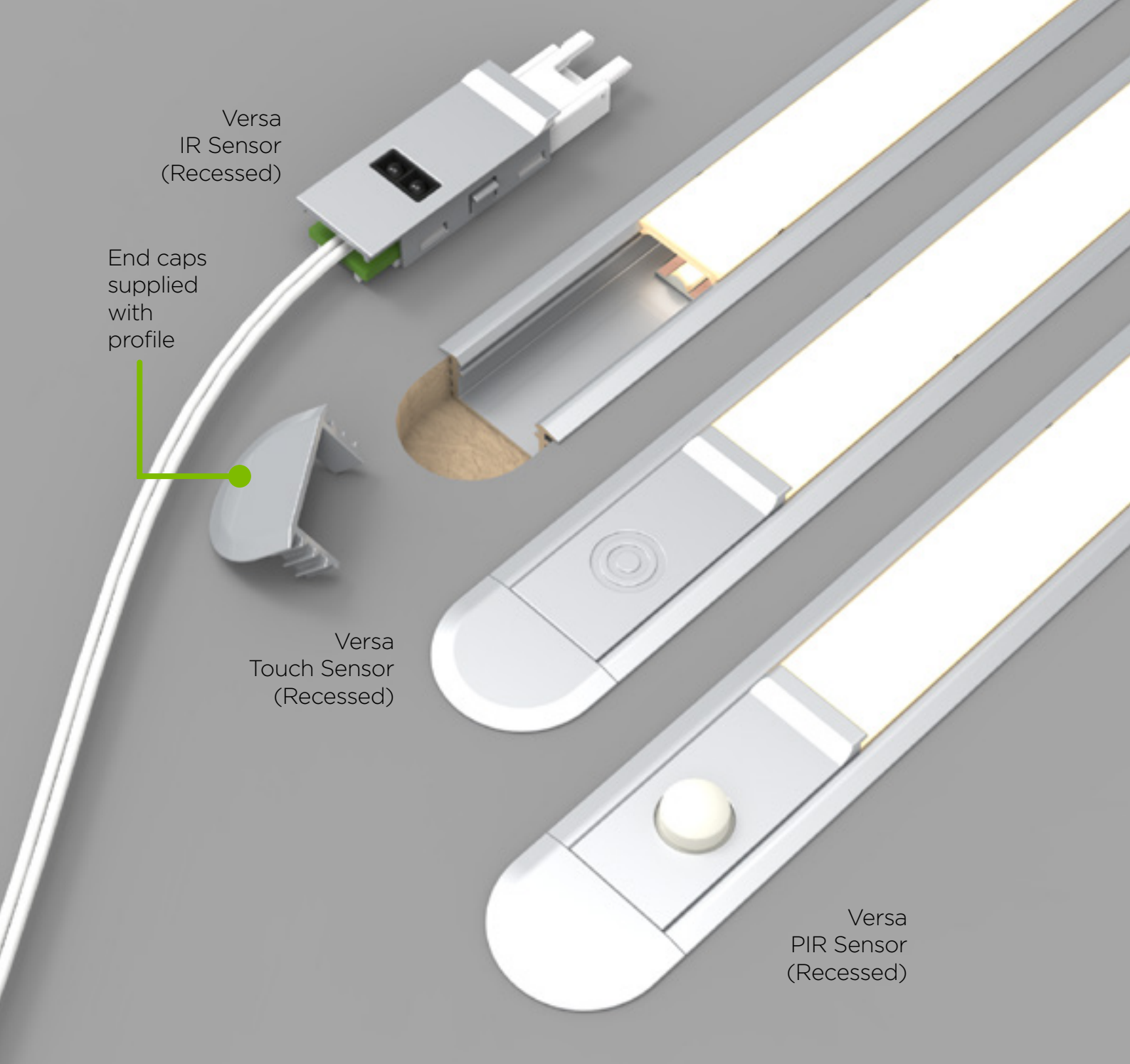

Versa - Recessed profile

SKU	Details	Dimensions	RRP
SE00295	Versa - Recessed	2500mm x 22mm x 9mm	£22.92
SE00312	Versa - IR Sensor	14.5mm x 9mm x 50mm	£8.60
SE00311	Versa - PIR Sensor	14.5mm x 12mm x 50mm	£9.66
SE00313	Versa - Touch Sensor	14.5mm x 9mm x 50mm	£8.08

Available to order from 5th March 2026

VERTEX

The Vertex LED shelf light is a slim fitting, up and down directional shelf light and profile designed to sit on the back of shelf boards. No need to trim the shelf for installation. The power cable exits backwards, this can span perfectly all the way across the shelf with no exposed wires. This is a fully integrated solution, with pre-installed strips.

- Single Colour: Natural white light (4000K).
- Easy Fit: No need to trim the shelf for installation.
- Rear cable placement: For concealing power cables.
- Free cut: Can be cut to any desired length.
- VHB (Very High Bond): adhesive tape backing for secure installation.
- Shelf Compatible: Designed to work with standard shelf sizes 50cm, 60cm and 1m.
- Registered design right: 6443843.

“

“Working with installers to design rear cable entry for seamless wire management.”

Product Design Team, Sensio.



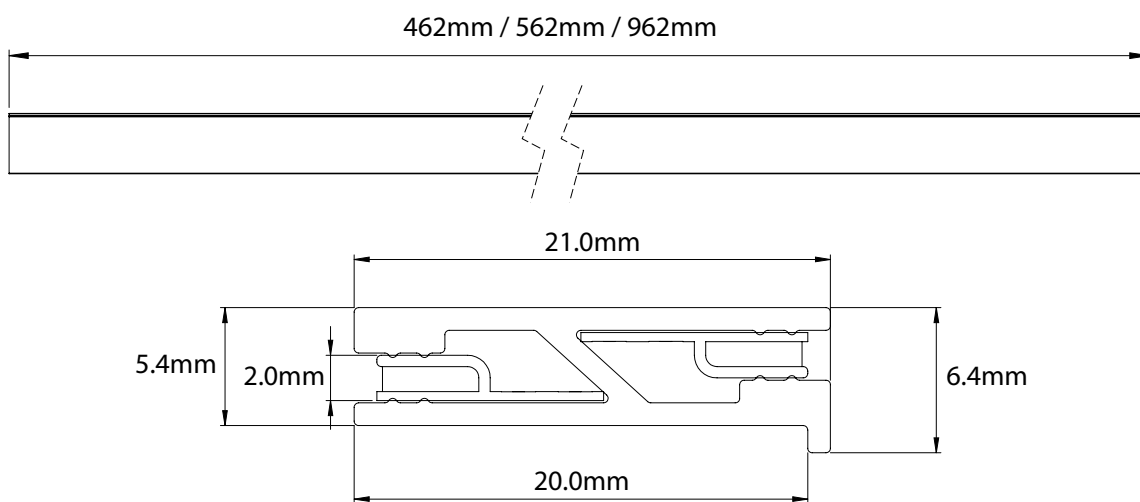

Shelf light - Natural - 4000K

SKU	Dimensions	Wattage	Lumens	Colour	RRP
SE00164	462mm x 6.4mm x 21mm	12 W/m	508 lm/m	Natural	£36.70
SE00165	562mm x 6.4mm x 21mm	12 W/m	508 lm/m	Natural	£40.51
SE00166	962mm x 6.4mm x 21mm	12 W/m	508 lm/m	Natural	£63.85

Available to order from 21st November 2025



POWER

Drivers, Connectors & Controls For All Solutions

Whatever your control or chosen lights we've simplified the driver choice between 3 power houses, while simplifying connection too.



sensio
integrated lighting solutions
100% LED

INPUT: 220-240V
OUTPUT: 12V
ta: 40°C

Smart - 30W - Single Colour - Kinetic Compatible

50/60Hz, 0.2A Max, PF > 0.9
1.25A Max, 30W Max

SELV



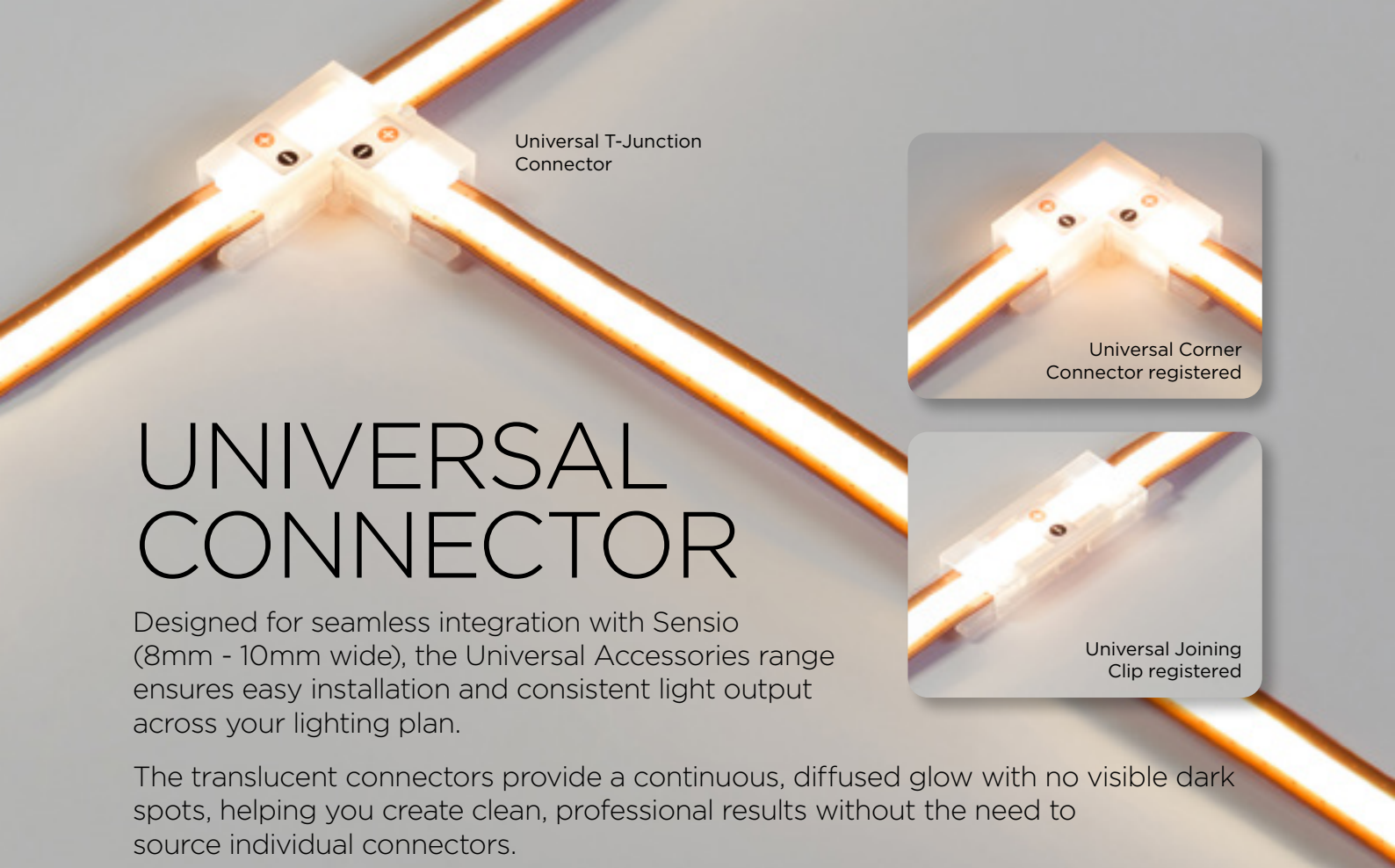

Universal T-Junction Connector

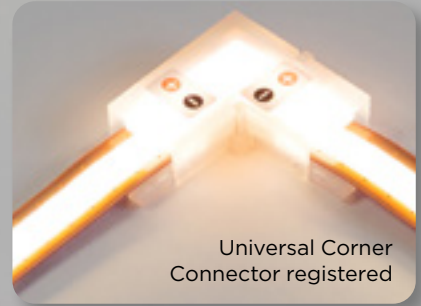

Universal Corner Connector registered



Universal Joining Clip registered

UNIVERSAL CONNECTOR

Designed for seamless integration with Sensio (8mm - 10mm wide), the Universal Accessories range ensures easy installation and consistent light output across your lighting plan.

The translucent connectors provide a continuous, diffused glow with no visible dark spots, helping you create clean, professional results without the need to source individual connectors.

- Join two LED strips at a 90° angle, perfect for perimeter or corner lighting installations. Universal Corner Connector registered Design Right: 6428459.
- Easily link two LED strips together for longer continuous runs. Universal Joining Clip registered Design Right: 6428458.
- Join two LED strips at a 90° angle, perfect for perimeter or corner lighting installations. Universal T-Junction Connector registered Design Right: 6428460.



Universal Driver Lead

Designed for seamless integration with Sensio (8mm - 10mm wide) LED strips, the Universal Accessories range ensures easy installation.

2500mm cable length to extend the distance between two LED strips.

- Registered Design Right: 6428456 (Single colour).
- Registered Design Right: 6428457 (CCT).

Accessories

SKU	Details	RRP
SE00175	Universal 2500mm Driver Connection Lead (2-pin)	£3.60
SE00176	Universal 2500mm Driver Connection Lead (4-pin)	£4.74
SE00177	Universal 1500mm Interconnecting Lead	£3.65
SE00179	Universal Corner Connector	£2.61
SE00178	Universal Joining Clip	£2.06
SE00180	Universal T-Junction Connector	£2.61
Compatibility: Works with, Primo 2, Primo X, Sigma 2, Polar, Polar Pro, Polar X & Polar Pro X		

Available to order from 26th October 2026



Cool



Natural

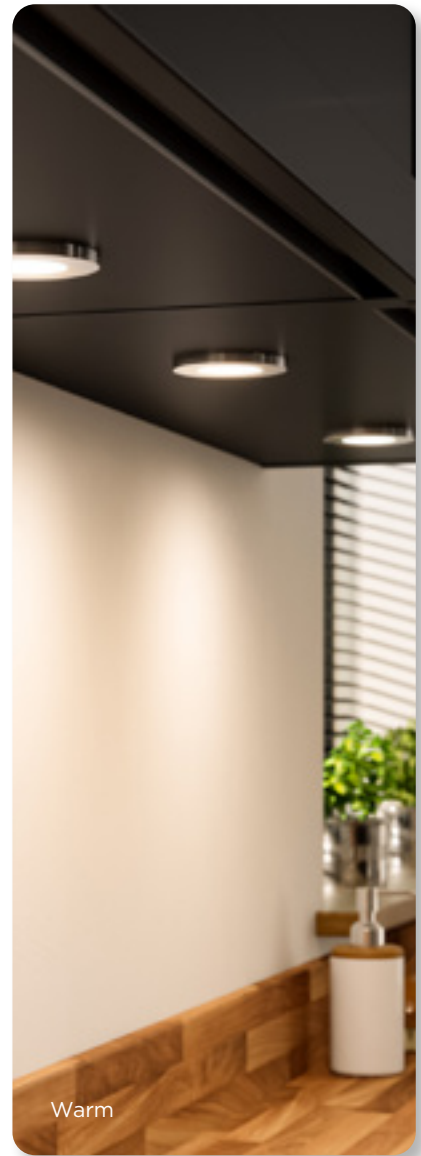

Warm

TRIOTONE® CONTROL

Simplifies Colour Selection

The controller plugs directly into any standard LED driver, making any CCT product TrioTone® compatible. This enables the light source to be matched to any interior design style, as well as providing the flexibility to be changed in the future.

TrioTone® Control

SKU	RRP
SE090009A0	£11.93



JB4 DETACHABLE DRIVER CONNECTORS

No need for large cable holes with the detachable JB4 connector. Simply cut the lead to the required length and attach the JB4 clip, you don't even need to strip the cable!

- Compatibility: Use any Sensio lighting products that require a driver lead.
- Availability: 2-pin (Single colour or TrioTone®) and 4-pin (CCT).
- Patent protected: P47523GB1.

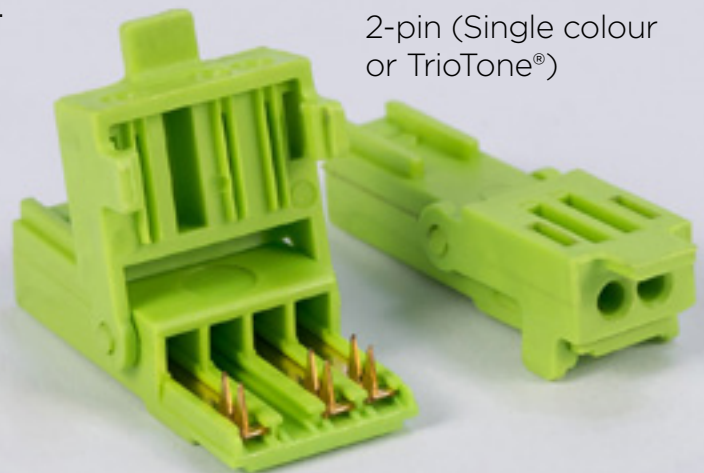

2-pin (Single colour or TrioTone®)

4-pin (CCT)

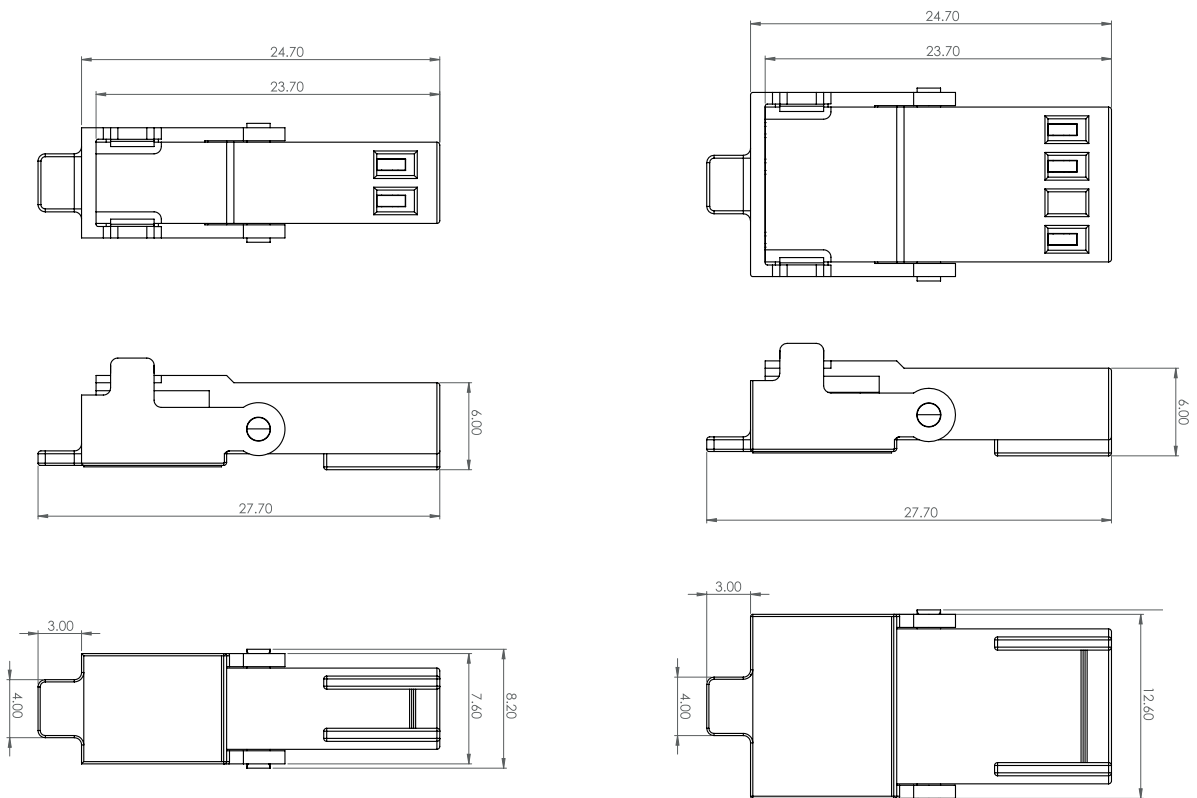

JB4 DETACHABLE DRIVER CONNECTORS

SKU	Details	Qty	RRP
SE00251	2-pin (Single colour)	10	£16.50
SE00252	4-pin (CCT)	10	£18.98

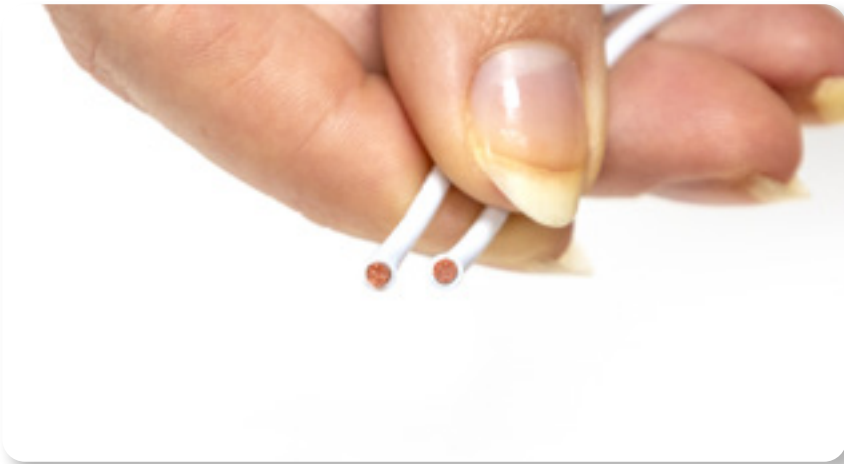

Step 1.

Cut the wire.



Step 2.

Feed the wire through your pre drilled hole.



Step 3.

Insert the copper with into the two holes and press the connector lid down.



Step 4.

Insert the JB4 connector into your driver.



Delivering full dimmable options, we've developed two ranges of drivers which offer dimmability.

Titan Dimmable is designed to handle dimming voltage from mains, input max 230V, typically controlled by a wall mounted dimmer switch.

Our Titan + range of drivers are designed to handle dimmable output at max 24V, controlled with a sensor or receiver placed after the driver.

TITAN DIMMABLE

Designed to Handle Lower Load

We've made our lighting too efficient! For a power supply to be able to dim lighting efficiently, they need a minimum load. So, we're adding a smaller, 15W driver to our dimmable range. Ideal for use with shorter lighting runs and our low wattage fittings.



Control with a standard mains dimmer.

TIP

Consider the wattage. Dimmable drivers require a **minimum 25% load** to function efficiently.

- For **15W**, connect a minimum **3.75W** of lighting
- For **30W**, connect a minimum **7.5W** of lighting
- For **60W**, connect a minimum **15W** of lighting

Titan Dimmable - Compatible with a wall dimming switch

SKU	Driver	No. Ports	RRP
SE40699	Titan 60W Dimmable Driver	10	£52.39
SE40899	Titan 30W Dimmable Driver	6	£44.86
SE40799	Titan 15W Dimmable Driver	6	£26.58

TITAN+ DRIVER

High capacity for longer light runs

We're introducing a 150W driver to our Titan+ range to create longer runs of flexible strip lighting or simplify installation, allowing many lights to be illuminated from one power source.



Control with our wireless sensors, see page 54

Titan+ - Plug & play sensor drivers

SKU	Driver	No. Ports	RRP
SE150014A0	Titan+ 150W Driver NEW	6	£85.50
SE150004A0	Titan+ 60W Driver	6	£50.90
SE497950	Titan+ 30W Driver	6	£49.69
SE496950	Titan+ 15W Driver	6	£30.49
SE495950	Titan+ 6W Driver	4	£25.01

TITAN SMART KINETIC DRIVER

High Capacity for Longer Light Runs

We've re-engineered our smart drivers for increased kinetic wireless range and reliability.



Control with the Link Sensio app or other smart devices

Titan Smart Kinetic Driver - Single Colour (2-pin)

SKU	Driver	Channel	No. Ports	RRP
SE00056	Titan Smart Kinetic Driver 60W NEW	5	5	£75.36
SE406591	Titan Smart Kinetic Driver 30W	5	5	£72.16
SE406581	Titan Smart Kinetic Driver 15W	5	5	£62.12

Titan Smart Kinetic Driver - CCT (4-pin)

SKU	Driver	Channel	No. Ports	RRP
SE00057	Titan Smart Kinetic CCT Driver 60W NEW	3	6	£76.56
SE406592	Titan Smart Kinetic CCT Driver 30W	3	6	£73.93
SE406582	Titan Smart Kinetic CCT Driver 15W	3	3	£62.70

New drivers available to order from 13th January 2026

TITAN+ WIRELESS SENSOR RANGE



Eliminate the hassle of wires and cables with the Titan + Wireless range. Available in 4 different sensor options, giving a choice of control and allowing bespoke product creation. As well as ease of use, the Titan+ Wireless range reduces energy consumption, as they don't require a constant power supply or connection.

- No messy wires to hide.
- Perfect for surface mounting with the included bracket.
- Available in 4 types - Touch, IR, Door and PIR sensor.
- Compatible with the Titan+ Driver.
- Easily pair up to 10 sensors to one receiver for wireless connection.
- Detection range from sensor to receiver: up to 5m.



Discreet control anywhere.



One switch - controls all driver channels

Effortless - one touch pairing



Quick connect
- receiver plugs directly
into the Titan+ port

Low profile
- sensor and
bracket design



Intuitive hand-gesture control without the need to route extra cables



Titan+ Wireless IR Sensor

- Activate by swiping hand in front of sensor or dim the lights by holding hand in front of sensor.



Titan+ Wireless PIR Sensor

- Lighting will activate with movement from up to 2.5m.



Titan+ Wireless Door Sensor

- Activate lighting by opening the cabinet door. Works for both single and double doors.



Titan+ Wireless Touch Sensor

- Tap sensor to turn lighting on/off. Tap and hold sensor for 5 seconds to dim lighting.

Sensors & Receivers

SKU	Sensor Type	RRP
SE900530	Titan+ Wireless IR Sensor and Receiver	£22.39
SE900730	Titan+ Wireless Touch Sensor and Receiver	£25.25
SE900830	Titan+ Wireless Door Sensor and Receiver	£25.60
SE900630	Titan+ Wireless PIR Sensor and Receiver	£31.80

Individual Components

SKU	Sensor Type	RRP
SE900030	Titan+ Wireless IR Sensor	£13.92
SE900230	Titan+ Wireless Touch Sensor	£13.56
SE900330	Titan+ Wireless Door Sensor	£14.29
SE900130	Titan+ Wireless PIR Sensor	£15.82
SE900430	Titan+ Wireless Receiver	£8.68

Additional Sensors - pair up to 10 sensors with one receiver



“We don’t just develop products, we help you understand them.

Our training team have trained over 10,000 designers and installers annually, from helping with lighting plans to large scale training seminars. We believe in being your lighting partner for life.”

Andrew Sheppard
Training Manager



sensio



GET IN TOUCH

We hope you enjoy this Sensio brochure and are inspired to discover how lighting can transform the home. When you have finished with it, please pass it on or recycle it.

Please note that the colours in this brochure are as accurate as the printing process will allow, and we recommend that you view a product prior to purchase. All prices are inclusive of 20% VAT and are Sensio's recommended retail prices. Prices and technical information are correct at the time of print (November 2025) and are subject to change throughout the course of the year without prior notification. Errors and omissions excepted. For more information on our terms and conditions, please visit sensiolighting.com/pages/terms-and-conditions

Get the latest in lighting

Keep up to date with product news and information from us at Sensio.



/sensiolighting



@sensiolighting



/sensiolighting

INNOVATE 26

innovate. create. illuminate™



Sensio Lighting Ltd
Unit 7 Speedwell Road, Castleford,
West Yorkshire, WF10 5PY

(+44) 01977 522020
info@sensiolighting.com
www.sensiolighting.com