

# FLOWPRO®

Get Pumped!

Quality Range of Macerators at Unbeatable Value



- COMPACT, NEAT AND UNOBTRUSIVE**
- EASY ACCESS FOR SERVICING AND MAINTENANCE**
- CAPACITY FOR AN EN-SUITE INSTALLATION**
- QUIET TECHNOLOGY**

SUITABLE FOR	FP400	FP400B	FP400S	FP400K	FP250	FP800
Toilet	●	●				●
Back to Wall Toilet			●			
Wall Hung Toilet			●			
Hand Basin	●	●	●	●	●	●
Shower	●	●	●	●	●	●
Bath				●		
Bidet	●	●	●	●	●	●
Kitchen Sink				●		
Washing Machine				●		
Dishwasher				●		
Heavy use/light commercial				●		●

Watch my review

# FLOWPRO®

## FP400 Macerator for WC and Bathroom - Side Outlet

### Why Choose This Product?

- Ideal for full bathroom installations (WC & multiple connections)
- Easy access for servicing and maintenance - No need to remove the unit, no screws
- Capacity for an en-suite installation
- Quiet technology
- Compact, neat and unobtrusive

### Product Dimensions

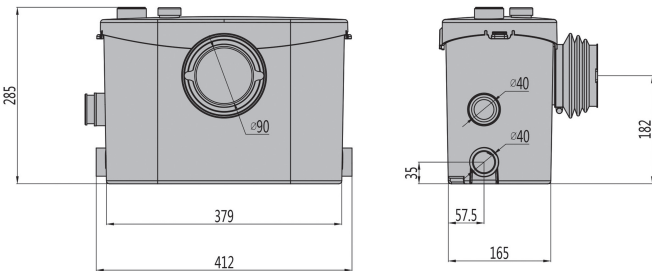

### Suitable for

- ✓ WC
- ✓ Basin
- ✓ Shower
- ✓ Bidet

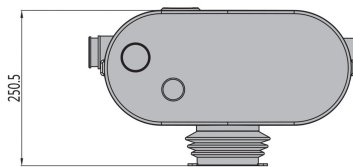

### Technical Data

Watts (Consumption)	400w
Electrical Supply	220-240V 50Hz
Flow rate at max head L/min	135 L/min
Horizontal Discharge	95 metres
Vertical Discharge	9.5 metres
Discharge Pipe	22mm/28mm/32mm/40mm
Inlet Pipe	1 x 100mm/3 x 40mm
Water Temperature	Min 1°C Max 90°C
IP Rating	IPX4

### Discharge Height / Flow Rate

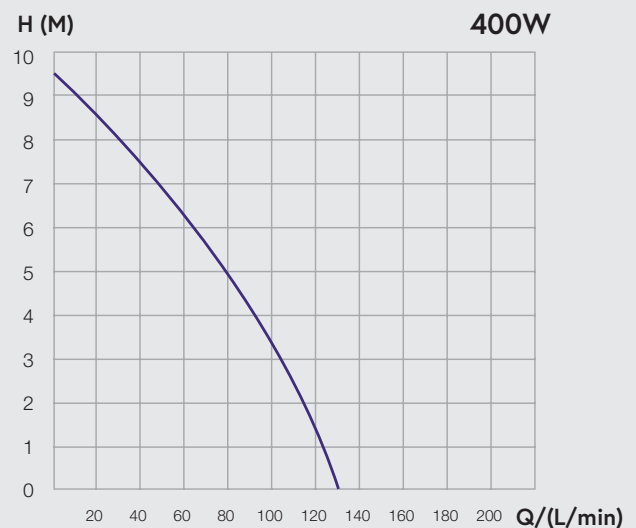

**ENSURE THERE IS ADEQUATE FALL ON ALL PIPEWORK**



# FLOWPRO®

## FP400B Macerator for WC and Bathroom - Top Outlet

### Why Choose This Product?

- Additional top outlet for increased installation flexibility, ideal for the retrofit market
- Easy access for servicing and maintenance - No need to remove the unit, no screws
- Capacity for an en-suite installation
- Quiet technology
- Compact, neat and unobtrusive

### Product Dimensions

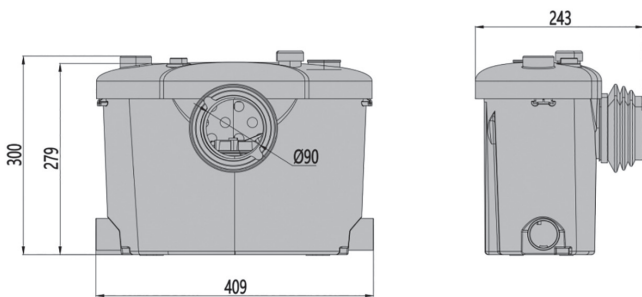

### Suitable for

- ✓ WC
- ✓ Basin
- ✓ Shower
- ✓ Bidet

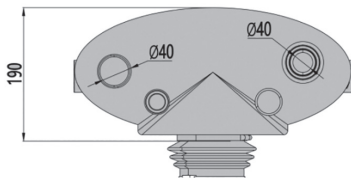

### Technical Data

Watts (Consumption)	400w
Electrical Supply	220-240V 50Hz
Flow rate at max head L/min	135 L/min
Horizontal Discharge	85 metres
Vertical Discharge	8.5 metres
Discharge Pipe	22mm/28mm/32mm/40mm
Inlet Pipe	1 x 100mm/3 x 40mm
Water Temperature	Min 1°C Max 90°C
IP Rating	IPX4

### Discharge Height / Flow Rate

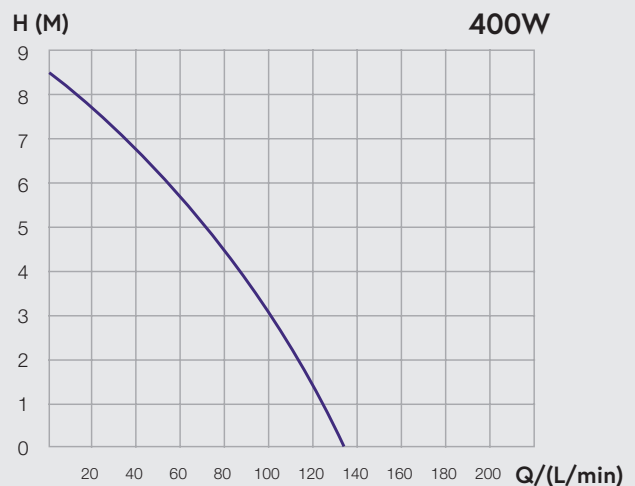

**ENSURE THERE IS ADEQUATE FALL ON ALL PIPEWORK**



# FLOWPRO®

## FP400K Grey Water Pump for Kitchen, Utilities & Bath

### Why Choose This Product?

- Designed to handle grey water from appliances and baths, suitable for domestic and light commercial use (i.e. Salons, Dental Surgeries)
- Easy access for servicing and maintenance - No need to remove the unit, no screws
- Quiet technology
- Compact, neat and unobtrusive

### Product Dimensions

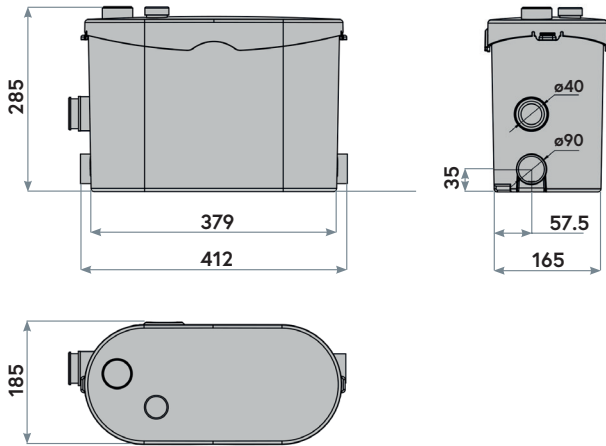

### Suitable for

- ✓ Basin
- ✓ Bath
- ✓ Shower
- ✓ Bidet
- ✓ Dishwasher
- ✓ Washing Machine
- ✓ Kitchen Sink



### Technical Data

Watts (Consumption)	400w
Electrical Supply	220-240V 50Hz
Flow rate at max head L/min	135 L/min
Horizontal Discharge	105 metres
Vertical Discharge	10.5 metres
Discharge Pipe	22mm/28mm/32mm/40mm
Inlet Pipe	3 x 40mm
Water Temperature	Min 1°C Max 90°C (48 hours) and 100°C (30 mins)
IP Rating	IPX4

### Discharge Height / Flow Rate

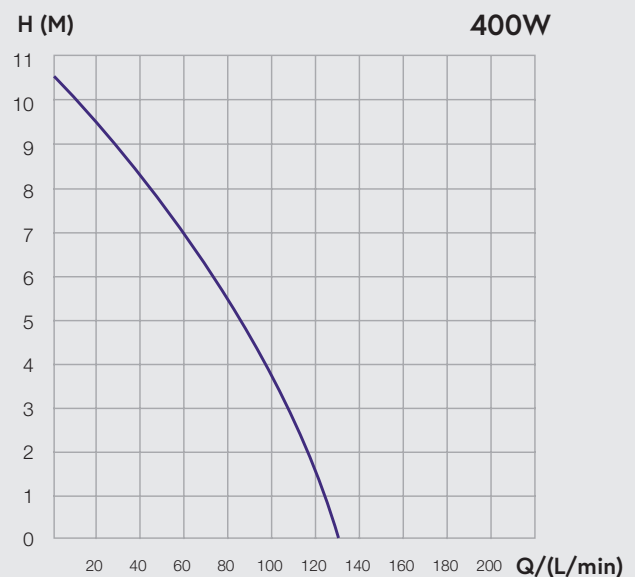

**ENSURE THERE IS ADEQUATE  
FALL ON ALL PIPEWORK**

# FLOWPRO®

## FP400S Slim Macerator for Wall Hung WC and Bathroom

### Why Choose This Product?

- Slim profile designed for back-to-wall and wall-hung WCs
- Easy access for servicing and maintenance  
- No need to remove the unit, no screws
- Capacity for an en-suite installation
- Quiet technology
- Compact, neat and unobtrusive

### Product Dimensions

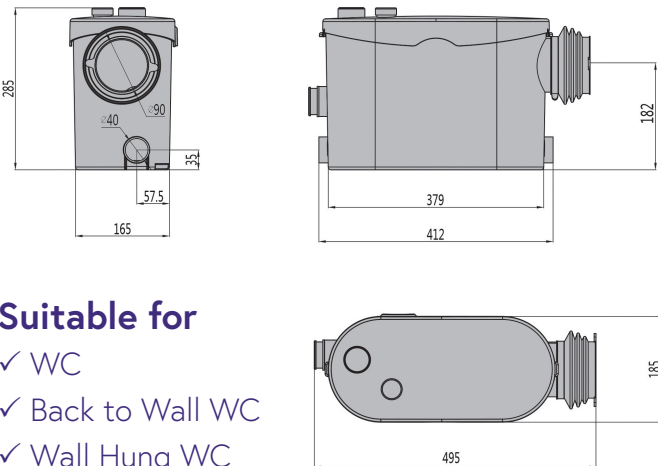

### Suitable for

- ✓ WC
- ✓ Back to Wall WC
- ✓ Wall Hung WC
- ✓ Basin
- ✓ Shower
- ✓ Bidet



### Technical Data

Watts (Consumption)	400w
Electrical Supply	220-240V 50Hz
Flow rate at max head L/min	135 L/min
Horizontal Discharge	95 metres
Vertical Discharge	9.5 metres
Discharge Pipe	22mm/28mm/32mm/40mm
Inlet Pipe	1 x 100mm/3 x 40mm
Water Temperature	Min 1°C Max 90°C
IP Rating	IPX4

### Discharge Height / Flow Rate

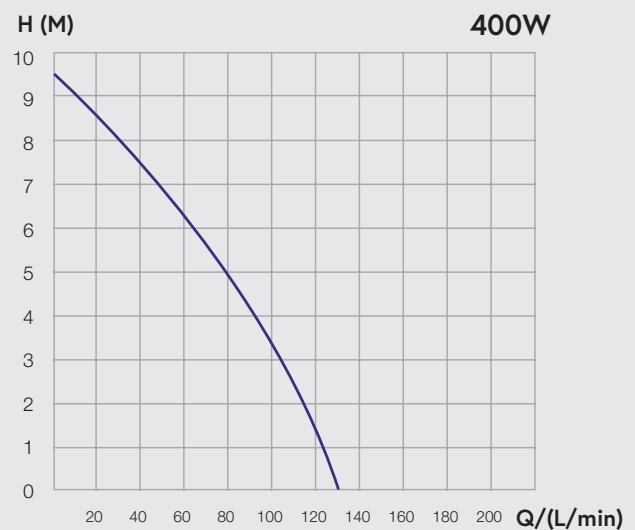

**ENSURE THERE IS ADEQUATE FALL ON ALL PIPEWORK**

# FLOWPRO®

## FP250 Grey Water Pump for Showers

### Why Choose This Product?

- Ideal for shower and basin installations where a full macerator is not required
- Quiet technology
- Compact, neat and unobtrusive

### Product Dimensions

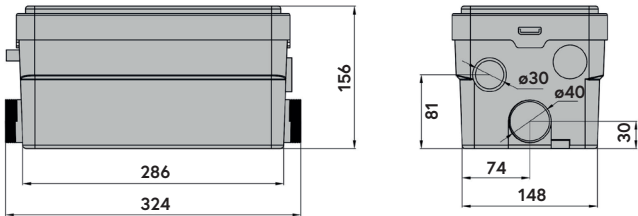

### Suitable for

- ✓ Basin
- ✓ Shower
- ✓ Bidet

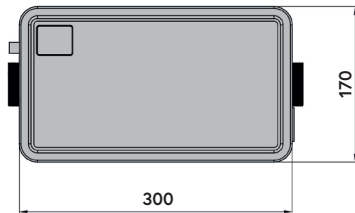

### Technical Data

Watts (Consumption)	250w
Electrical Supply	220-240V 50Hz
Flow rate at max head L/min	135 L/min
Horizontal Discharge	100 metres
Vertical Discharge	10 metres
Discharge Pipe	22mm/28mm
Inlet Pipe	2 x 40mm
Water Temperature	Min 1°C Max 90°C
IP Rating	IPX7

### Discharge Height / Flow Rate

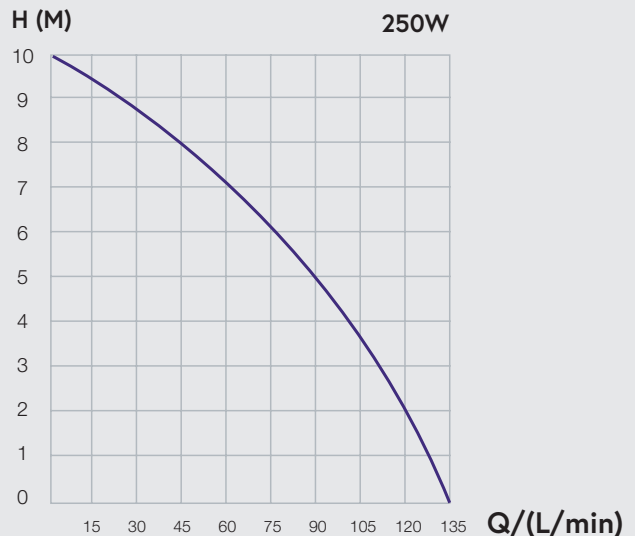

**ENSURE THERE IS ADEQUATE  
FALL ON ALL PIPEWORK**



# FLOWPRO®

## FP800 Macerator for Light Commercial and Heavy Use

### Why Choose This Product?

- Easiest access for servicing/maintenance - motor removeable in situ
- Capacity for an en-suite installation
- Voice alarm to alert when maintenance required

### Product Dimensions

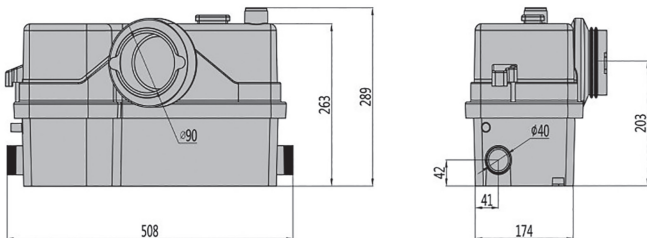

### Suitable for

- ✓ WC
- ✓ Basin
- ✓ Shower
- ✓ Bidet
- ✓ Heavy Use/Commercial

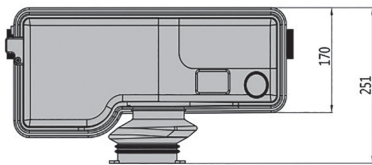

### Technical Data

Watts (Consumption)	800w
Electrical Supply	220-240V 50Hz
Flow rate at max head L/min	170 L/min
Horizontal Discharge	90 metres
Vertical Discharge	9 metres
Discharge Pipe	22mm/28mm/32mm/40mm
Inlet Pipe	1 x 100mm/3 x 40mm
Water Temperature	Min 1°C Max 50°C
IP Rating	IPX4

### Discharge Height / Flow Rate

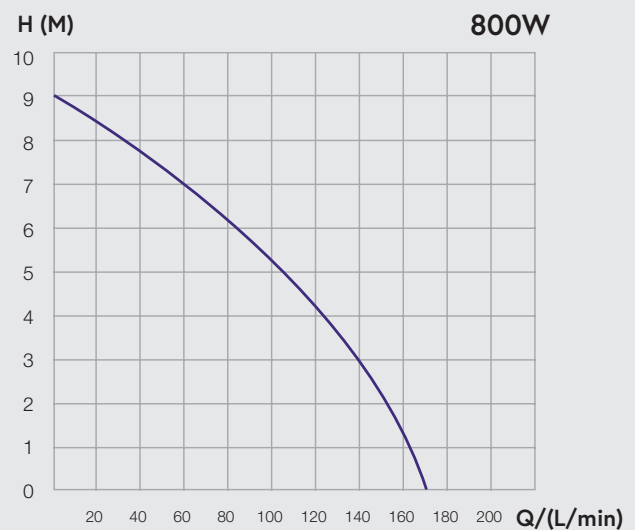

**ENSURE THERE IS ADEQUATE FALL ON ALL PIPEWORK**



# MARK VITOW™



020 8207 3784



[sales@markvitow.com](mailto:sales@markvitow.com)



[www.markvitow.com](http://www.markvitow.com)



[online.markvitow.com](http://online.markvitow.com)

**MARK VITOW LIMITED**