

Panasonic

DOMESTIC RANGE
2026 / 2027

TOTAL HVAC&R SOLUTION

ETHEREA
POWER HEAT



heating & cooling solutions

Panasonic

ETHEREA
POWER HEAT

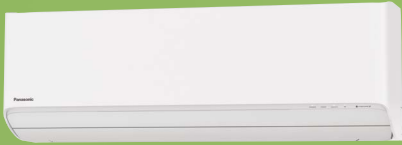

Panasonic domestic air to air heat pump

Panasonic has developed a range of products designed for you, better than ever before. Above all, it is also a range for air conditioning professionals, such as yourself, thanks to its broad range of products which are capable of conditioning rooms of all sizes – always with optimal efficiency and incomparable ease of installation.

ABOUT

Highlighted features	→ 4
Bringing nature's balance indoors	→ 6
<hr/>	
Etherea with nanoe™ X technology	→ 8
Wall-mounted TZ super-compact	→ 10
Super-compact units	→ 12
Floor console	→ 14
Power Heat Multi system	→ 16
<hr/>	
Panasonic R2 rotary compressor	→ 18
R22 Renewal	→ 20
<hr/>	
Panasonic Comfort Cloud App	→ 22
Voice Control	→ 24
Control and connectivity	→ 26
<hr/>	
Domestic air conditioner R32 range	→ 28
<hr/>	
Compare split solutions	→ 44
Single split feature overview	→ 45
Features explained	→ 46

PRODUCT SPECIFICATIONS

Wall-mounted

Etherea · R32	→ 30
TZ super-compact · R32	→ 31
BZ super-compact · R32	→ 32
UZ super-compact · R32	→ 33

More options for your home

Floor console · R32	→ 34
Low static pressure hide-away · R32	→ 35
RAC Solo · R290 / R32	→ 42

Multi split systems

Free Multi system	→ 38
Power Heat Multi system	→ 40
Multi wall TZ system	→ 41

Accessories and control	→ 48
-------------------------	------

Highlighted features

With innovative design, high-efficiency and advanced technologies, such as the Panasonic Comfort Cloud App for smart control and nanoe™ X for indoor air quality improvement, the residential range has been designed with you and your clients in mind.



More comfort. More savings. Cleaner air.

Panasonic air conditioners are engineered to deliver high performance, energy efficiency, and cleaner indoor air without compromising on comfort.

Discover the latest generation of air conditioning systems.

Designed with professionals in mind, Panasonic's newest air conditioning systems deliver a smart solution that prioritises quality, ease of installation, and long-term customer satisfaction.

BETTER INDOOR AIR QUALITY

nanoe™ X technology helps reduce viruses, bacteria, pollen, and odours — improving air quality in every room.



A RANGE OF PRODUCTS DESIGNED FOR EVERY HOME

From compact 1x1 units to full 5x1 systems, Panasonic offers reliable options to suit any installation need.



YEAR-ROUND COMFORT

Heating in winter, cooling in summer, and cleaner air all year. Panasonic solutions keep homes comfortable in every season.

Comfort that performs.

Panasonic air conditioners are engineered to deliver powerful cooling and heating with low energy consumption.

Their super silent operation makes them ideal for residential spaces, while advanced technology ensures reliable performance in everyday use.



nanoe™ X technology.

With the benefits of hydroxyl radicals that have the capacity to inhibit pollutants, viruses, and bacteria and deodorise.

The iF Product Design Awards are among the most prestigious awards for product design excellence.

Winning the award thanks to its highly intelligent functionality, the Panasonic floor console is the ideal air-conditioning system for domestic and commercial applications.



Bringing nature's balance indoors



nanoe™ X, technology with the benefits of hydroxyl radicals.

Abundant in nature, hydroxyl radicals (also known as OH radicals) have the capacity to inhibit pollutants, viruses, and bacteria to clean and deodorise. nanoe™ X technology can bring these incredible benefits indoors so that hard surfaces, soft furnishings, and the indoor environment can be a cleaner and more pleasant place to be.



What is unique about nanoe™ X?

Effective on fabrics and surfaces.

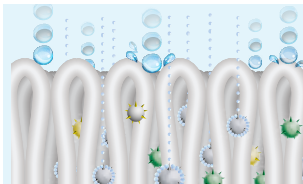

1 | At one billionth of a metre, nanoe™ X is much smaller than steam and can deeply penetrate cloth fabrics to deodorise.

Longer lifespan.



2 | Contained in tiny water particles, nanoe™ X has a long lifespan, which is about 600 seconds, to spread easily around the room.

Huge quantity.



3 | nanoe X Generator Mark 3 produces 48 trillion hydroxyl radicals per second. Greater amounts of hydroxyl radicals contained in nanoe™ X lead to higher performance on inhibition of pollutants.

Maintenance-free.

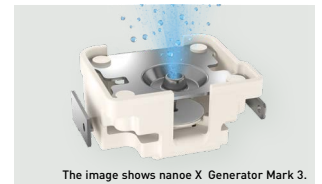

The image shows nanoe X Generator Mark 3.

4 | No service and maintenance required. nanoe™ X is a filter free solution that does not require maintenance, as its atomisation electrode is enveloped with water during its generation process and it is made with Titanium.

7 effects of nanoe™ X – Panasonic unique technology

Deodorises

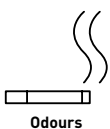

Odours

Capacity to inhibit 5 types of pollutants

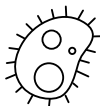

Bacteria and viruses

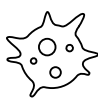

Mould



Allergens



Pollen



Hazardous substances



Skin and hair

* Refer to <https://aircon.panasonic.eu> for more details and validation data.

First nanoe™ device was developed by Panasonic in 2003

Generator: nanoe™

2003

480 billion hydroxyl radicals/sec

Ion particle structure

Hydroxyl radicals

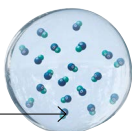

Generator: nanoe™ X

Mark 1 - 2016

4,8 trillion hydroxyl radicals/sec

10x times

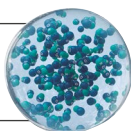

Mark 2 - 2019

9,6 trillion hydroxyl radicals/sec

20x times

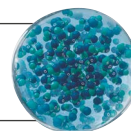

Mark 3 - 2022

48 trillion hydroxyl radicals/sec

100x times

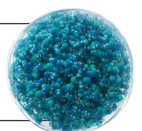

nanoe™ X, internationally-validated technology in testing facilities.

The effectiveness of nanoe™ X technology has been tested by 3rd party laboratories in Germany, France, Denmark, Japan and China.

The nanoe™ X performance varies depending on the room size, environment and usage and it may take several hours to reach the full effect. nanoe™ X is not medical device, local regulations on building design and sanitary recommendations must be followed. Test results conducted under controlled laboratory conditions. Performance of nanoe™ X might differ in real life environment.

	Tested contents	Generator	Result	Capacity	Time	Testing organisation	Report No.	
Airborne	Virus	Influenza (H1N1)	Mark 2	98,3% inhibited	30 m³	1,5 h	China Electronic Product Reliability and Environmental Testing Research Institute	J2003WT8888-00889
		Bacteriophage ΦX174	Mark 1	99,2% inhibited	Approx. 25 m³	6 h	Kitasato Research Center for Environmental Science	24_0300_1
	Bacteria	Staphylococcus aureus	Mark 1	99,7% inhibited	Approx. 25 m³	4 h	Kitasato Research Center for Environmental Science	24_0301_1
Adhering	Virus	SARS-CoV-2	Mark 1	91,4% inhibited	6,7 m³	8 h	Texcell (France)	1140-01 C3
		SARS-CoV-2	Mark 1	99,9% inhibited	45 L	2 h	Texcell (France)	1140-01 A1
		Bacteriophage ΦX174	Mark 1	99,8% inhibited	Approx. 25 m³	8 h	Japan Food Research Laboratories	13001265005-01
		Xenotropic murine leukemia virus	Mark 1	99,999% inhibited	45 L	6 h	Charles River Biopharmaceutical Services GmbH	—
		Coxsackie virus (CA16)	Mark 2	99,9%inhibited	30 m³	4 h	China Electronic Product Reliability and Environmental Testing Research Institute	J2002WT8888-00439
		Bacteriophage	Mark 3	98,81% inhibited	Approx. 139,3 m³	4 h	SGS Inc	SHES210901902584
	Bacteria	MS2 Phage Virus	Mark 3	99,99% inhibited	Approx. 25 m³	2 h	Shokukanen, Inc.	227131N
		Staphylococcus aureus	Mark 1	99,9% inhibited	20 m³	8 h	Danish Technological Institute	868988
	Pollen	Cedar pollen	Mark 3	99%inhibited	Approx. 24 m³	12 h	Panasonic Product Analysis Center	H21YA017-1
		Ambrosia pollen	Mark 1	99,4% inhibited	20 m³	8 h	Danish Technological Institute	868988
	Odours	Cigarette smoke odour	Mark 1	Odour intensity reduced by 2,4 levels	Approx. 23 m³	0,2 h	Panasonic Product Analysis Center	4AA33-160615-N04
			Mark 3	Odour intensity reduced 1,7 levels	Approx. 139,3 m³	0,5 h	SGS Inc	SHES210901902478

Licensed in VDI 6022

Certification of a HVAC system under VDI 6022 guarantees that the system fulfills the market's strictest hygiene requirements.



VDI 6022 – Part 5 ¹⁾ Certification.

Avoidance of allergenic exposure.

Inhibits a wide range of harmful bacteria, viruses, mould, pollen and allergens.



VDI 6022 – Part 1 ¹⁾ & 1.1 ²⁾ Certification.

Ventilation and indoor-air quality.

Panasonic nanoe™ X technology improving indoor air quality.

1) Certification mark only valid for nanoe X Generator Mark 3. 2) Certification mark only valid for nanoe X Generator Mark 2 and Mark 3.

nanoe™ X: improving protection 24/7.

Acts to clean the work area, such as meat or fish handling in hotel kitchens, food handling in industrial processes, laboratories, wine cellars, etc. So that the indoor environment can be a cleaner and more pleasant place to be all day long and keep the processes in better bacterial conditions. nanoe™ X works together with the cooling function when during the day but can work independently when the area is not occupied. Give the system the strength to increase the protection of persons, air, colds stuffs and working surfaces with nanoe™ X technology and convenient control via the Panasonic Comfort Cloud App.

Cleans the air even when there is no work activity.
Leave the nanoe™ X mode ON to inhibit certain pollutants and deodorize before start the work activity again.

Improves your environment and better protects the products handled when you are or not at work.
Enjoy a cleaner comfortable space both when working indoors and simply when it comes to better protecting products in the cold room.



Panasonic Heating & Cooling Solutions is incorporating nanoe™ technology in a wide range of equipment

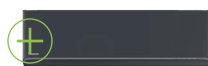

NEW! Wall-mounted Etherea.
Built-in nanoe X Generator Mark 3.



NEW! Floor console.
Built-in nanoe X Generator Mark 3.



NEW! Wall-mounted TZ super-compact.
Built-in nanoe X Generator Mark 2.



nanoe™ X: improving protection 24/7

New Etherea with nanoe™ X technology

Etherea features nanoe™ X technology, class-leading performance, intelligent features, and a stylish design. It is designed to make your home comfortable, clean and the ideal place to be.

ETHEREA

Available in 3



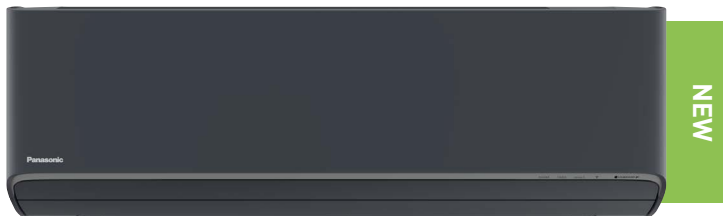

SEE PRODUCT SPECIFICATIONS

Air quality – nanoe™ X technology

Ethera is equipped with the latest nanoe X Generator Mark 3.

By releasing up to 48 trillion hydroxyl radicals per second, 100x more hydroxyl radicals than the traditional nanoe™, it actively works to clean the air and surfaces in your home. This advanced technology helps create a cleaner and more pleasant indoor environment.

- 24/7 cleaner air – Works independently of heating or cooling modes
- Internal cleaning – Can inhibit up to 99% of adhered bacteria and mould inside the unit. Cross flow fan coating reduces dust adhesion by 62,5%*
- Maintenance-free – No filters or replacements required

* Based on Panasonic internal testing. Performance may vary depending on usage conditions.

Comparison of time required to inhibit 99% of cedar pollen.

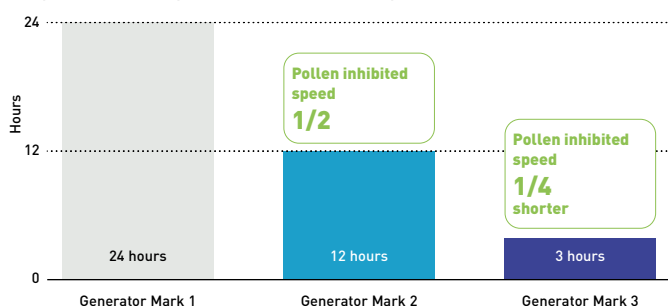

Advanced Internal cleaning with nanoe™ X.

nanoe™ X acts to inhibit 99% of adhered bacteria, viruses, and mould inside the unit.

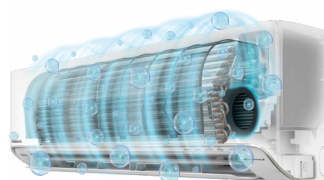

* Based on Panasonic internal testing. Performance may vary depending on usage conditions.

Cross flow fan coating reduces dust adhesion by 62,5%*.

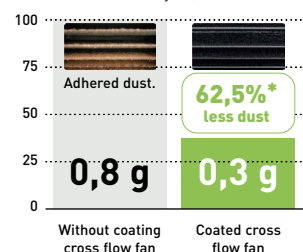

Optimised energy performance.

Ethera provides the highest level of comfort with a low energy consumption.

Its air to air heat pump technology ensures high efficiency all year round, while smart features help reduce running costs.

- A+++ SEER and SCOP ratings – Ensures year-round efficiency
- AI ECO Mode – Boost energy savings by up to 20% in cooling mode. Learns room conditions and balances energy saving with faster cooling

* In cooling mode.



Technology for the ultimate comfort

Ethera combines Aerowings 2.0, Panasonic's advanced air flow technology, with high-performance operation to deliver fast, even, and gentle comfort throughout the room.

- Aerowings 2.0 – Two independent vanes for fast and even air distribution
- Shower Cooling – Gentle air flow directed to the ceiling, avoiding direct cold drafts
- Floor Heating Effect – Concentrated warm air directed downward for cosy comfort
- Super Quiet operation – As low as 19 dB(A) for undisturbed comfort
- Reliable heating – Operates efficiently even at -20 °C outdoor temperatures

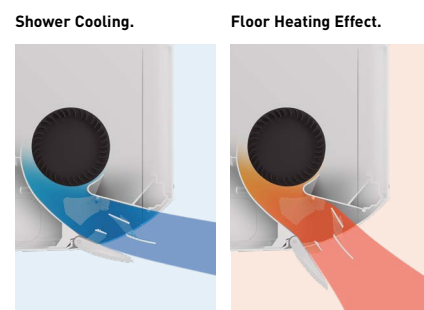

Built-in Wi-Fi. Works with Google Home and Alexa.



New Wall-mounted TZ super-compact with nanoe™ X

Smart comfort and cleaner air in a compact unit.

TZ features nanoe™ X technology with the benefits of hydroxyl radicals for a cleaner and more comfortable indoor environment.



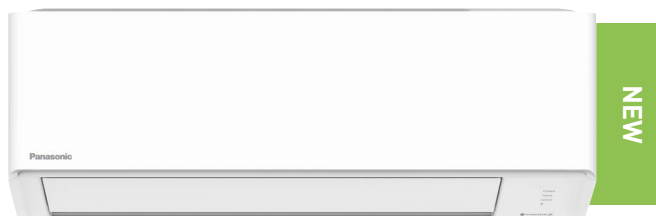

SEE PRODUCT SPECIFICATIONS 

Air quality – nanoe™ X technology

The TZ series are equipped with the nanoe X Generator Mark 2.

By releasing up to 9,6 trillion hydroxyl radicals per second to help inhibit pollutants in the air and on surfaces. It's a compact solution that brings a cleaner indoor environment, day and night.

- nanoe X Generator Mark 2 – 20x more hydroxyl radicals than the traditional nanoe™
- 24/7 cleaner air – Works independently of heating or cooling modes
- Maintenance-free – No filters or replacements required



Technology for the ultimate comfort

TZ combines Aerowings, Panasonic's advanced air flow technology, with Super Quiet operation to deliver fast, even, and gentle comfort throughout the room.

- Aerowings – Two vanes that concentrate air flow for fast and even air distribution
- Shower Cooling – Gentle air flow directed to the ceiling, avoiding direct cold drafts
- Super Quiet operation – As low as 20 dB(A) for undisturbed comfort

Aerowings.



Shower Cooling.



Super-compact design, smart details

The TZ series combines a super-compact indoor unit with smart design features for easier installation and servicing, effortless operation, and a clean, modern look without compromising performance.

- Super-compact size – Just 765 mm wide, ideal for tight spaces like above doors
- Easy installation 2.0 – Chassis and components designed for easier installation and servicing
- Ergonomic remote control – Backlit, intuitive layout with sliding cover for a clean look

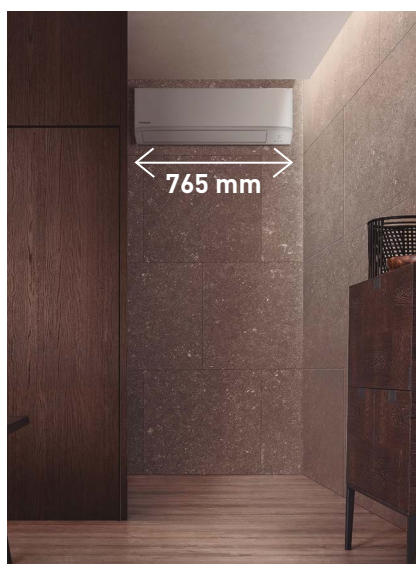

Built-in Wi-Fi.

Works with Google Home and Alexa.

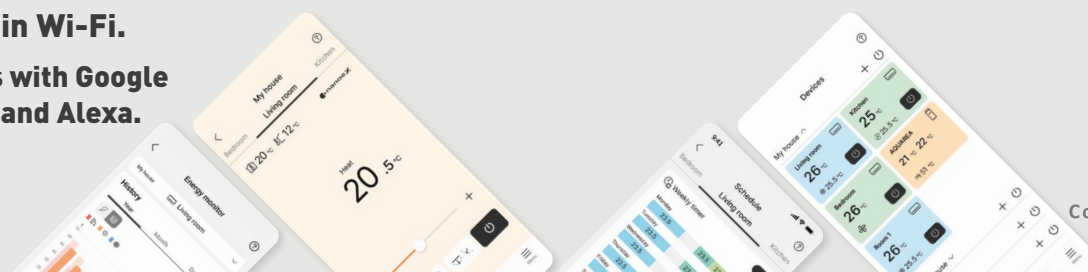

Comfort Cloud

Wall-mounted indoor units, designed for simple installation and maintenance

The full range of wall-mounted indoor units has been carefully designed for simple, stress-free installation and ongoing maintenance.





Simplified installation.

Latest design enhancements significantly reduce installation time. With reinforced structure and improved access to key components, such as the drain hose, cabling inserts and mounting supports, installation is faster, neater and more secure.

1. Stronger installation plate.

Provides greater stability, with additional screws for secure mounting on uneven surfaces.

Installation plate: Strong and solid.



Additional screw hole

Screw holder for uneven surface (screws not provided).



2. Built-in support holder.

Improves handling and provides a stable workspace.

Convenient installation and serviceability.



3. Easy connection of drain hose.

Enhanced piping space allows better accessibility, improving installation efficiency. Faster and more secure connection with a resin securing ring*.

* Available only for TZ, BZ, UZ-CKE.

Bigger working space.

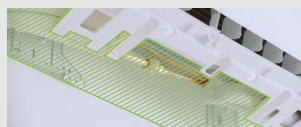

Lock mechanism of drain hose.



NEW

4. Easy wire insertion and tightening.

The models have combined 2 wire inserts into 1, ensuring front visibility and convenience while inserting wires from the back.

Single tunnel: easy wire insert.



Bigger working space for wiring connection.



Easy maintenance.

Meticulously designed for both installer and service technicians' benefit, the unit features an easy to remove front grille for convenient access to the interior. The inner workings of the unit have also been redesigned to make maintenance quicker and easier.

5. Easier front grille removal.

The model comes with a one-piece front grille secured with slider locks, reducing the need for screws and making servicing easier.

One-piece front grille: Easy removal.

Slider locks: Easy to unlock / lock.



NEW

6. Easier discharge grille removal.

The updated design replaces screws with clips, allowing faster and more convenient access for maintenance.

Clip fixing for easy removal of the discharge grille.

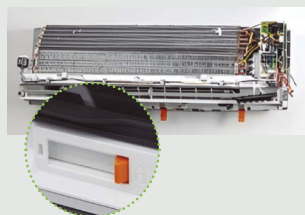

7. Simplified control board access.

The new models feature a redesigned control board with an easy-fix cover, allowing quicker and more convenient PCB removal for servicing.

Simple steps for PCB removal.

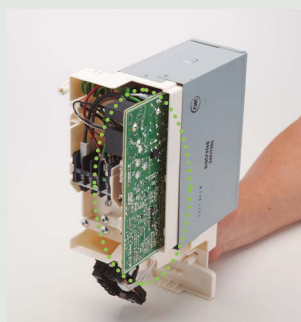

8. Easier fan removal.

The models are carefully designed to make removal of cross flow fans easier compared to the previous models, saving valuable time.

Bigger diameter: up to Ø105 (for Z-CKE).

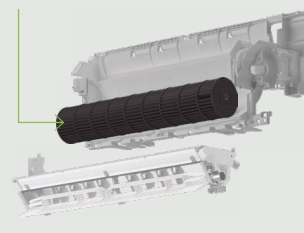

New floor console. Efficient comfort and clean air all year round

Delivering efficient heating and cooling, the floor console enhances indoor comfort with ultra-quiet operation and cleaner air thanks to nanoe™ X technology. With Wi-Fi built-in, it offers flexible, remote control.



Built-in Wi-Fi.
Works with Google
Home and Alexa.



Comfort Cloud



NEW

The iF Product Design Awards are among the most prestigious awards for product design excellence. Winning the award thanks to its highly intelligent functionality, the Panasonic Floor console is the ideal air-conditioning system for domestic and commercial applications.



SEE PRODUCT SPECIFICATIONS

Air quality – nanoe™ X technology

The new Panasonic's floor console is equipped with the latest nanoe X Generator Mark3.

By releasing up to 48 trillion hydroxyl radicals per second, 100x more hydroxyl radicals than the traditional nanoe™, it actively works to clean the air and surfaces in your home. This advanced technology helps create a cleaner and more pleasant indoor environment.

- 24/7 cleaner air – Works independently of heating or cooling modes
- Maintenance-free – No filters or replacements required

Comparison of time required to inhibit 99% of cedar pollen.

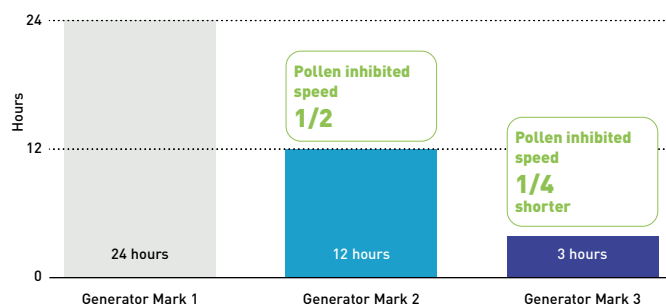

Technology for the ultimate comfort

Designed to deliver a superior indoor experience, the floor console combines advanced air flow control with whisper-quiet operation.

- Double air flow – Top air discharge ensures faster and more even temperature distribution
- Super Quiet operation – As low as 20 dB(A) for undisturbed comfort

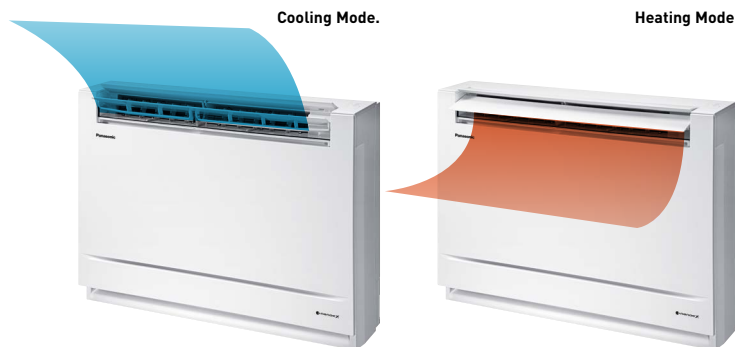

Smart design, seamless integration

The elegant and compact floor console is built to fit effortlessly into modern homes, offering style and efficiency.

- Ideal for renovation – A smart solution for replacing old boiler systems
- Reliable heating – Delivers warmth even at -15 °C outdoor temperatures
- Ergonomic remote control – Backlit, intuitive layout with sliding cover for a clean look

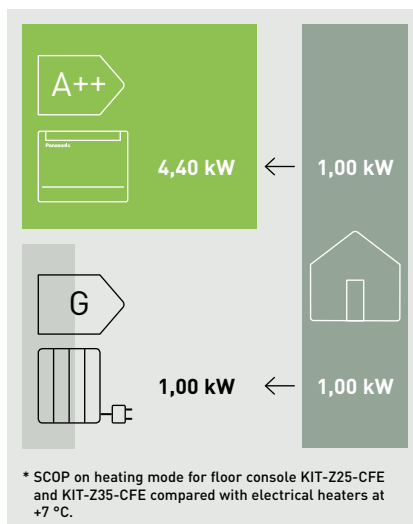
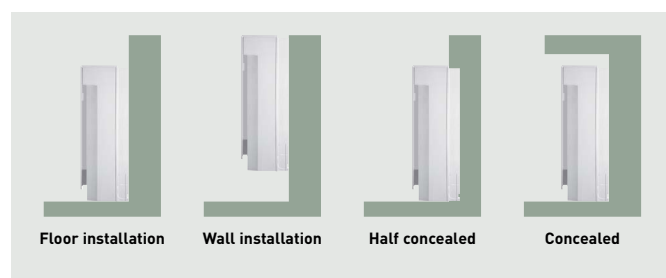

Power Heat Multi system

Powerful heating and cleaner indoor air from a single outdoor unit.

The multi split system engineered for cold climates.



Check out the installation of the Power Heat Multi system at the Arctic Treehouse Hotel in Lapland, Finland.



Powerful heating of two or three rooms with one outdoor unit, even at -25 °C low outdoor temperatures.

The multi split solution offers high flexibility, as 2 to 3 indoor units can be connected to a single outdoor unit.

POWER HEAT

SEE PRODUCT SPECIFICATIONS 

Reliable heating for the coldest winters.



RELIABLE HEATING EVEN AT -25 °C



EQUIPPED WITH BASE PAN HEATER



COMPATIBLE WITH ETHEREA INDOOR UNITS, WITH nanoe™ X

Reduces the burden of aesthetics, installation and maintenance.



SEAMLESS INTEGRATION OF OUTDOOR UNIT



REDUCED INSTALLATION TIME



EXCELLENT MAINTAINABILITY

Reduced outdoor unit space, harmonizing with building architecture.

Faster piping connection and pump-down time.

Advantageous under harsh conditions.



Etherea

-25 °C outdoor temperature operation and base pan heater.

The heater prevents the outdoor unit base pan from freezing and ensures stable operation even in extremely cold regions.

Heating capacity at -25 °C outdoor temperature: 3,90 kW for the 2-room model and 4,30 kW for the 3-room model.

Efficiently heats 2 or 3 rooms using a single outdoor unit, even in low outdoor temperatures.

High-efficiency SCOP 4,60 A++.

High heating efficiency contributes to environmental protection while reducing electricity bills.

Dark color outdoor unit.

First outdoor unit in dark color, blending seamlessly with home exteriors without compromising aesthetics.

Connectable to Etherea indoor units.

Comfort and convenience with nanoe™ X and built-in Wi-Fi, combined with excellent heating and cooling performance.

Shorter installation time (faster than two single units).

Requires shorter installation times compared to installing multiple single units, reducing the installer's workload.

Panasonic R2 rotary compressor

The secret is flexibility.

Panasonic Inverter air conditioners have the flexibility to vary the rotation speed of the compressor. This allows it to use less energy to maintain the set temperature while also being able to cool the room quicker at start up.

So you can enjoy better savings on your electricity bills while maintaining cooling comfort.



R2 rotary compressors utilize rolling piston technology. The R2 compressor has been tested in extreme conditions: higher efficiency, single and dual piston, R32 / R410A refrigerant, compact size.

Making the world a cooler place since 1978.

Panasonic rotary compressors for room air conditioners have been installed in the most demanding environments around the world. Designed to withstand extreme conditions, Panasonic Rotary delivers high performance, efficiency and reliable service, no matter where you are. Panasonic, the world's largest manufacturer of rotary compressors.

Why is the Panasonic R2 rotary compressor so efficient?

1. High-efficiency motor. The premium silicon steel motor meets industry efficiency requirements.
2. Improved lubrication of high volume oil pump. The extended, high volume oil pump in conjunction with a larger capacity oil reservoir provides superior lubrication.
3. Accumulator has larger refrigerant capacity. The larger accumulator accommodates generous refrigerant amounts needed in longer line length installations.



* This image is for 5,0 / 7,1 kW.

R2 compressor value

About R2 compressor.

Built upon 36 years of compressor design and production experience, R2 is the next generation of rotary compressors for residential central air conditioning. The technology improvements, enhanced materials and simple design ensure R2 compressors are reliable, efficient and quiet. The R2 compressor delivers quality, comfort and peace of mind in homes around the world. Panasonic's Rotary Compressors have been life tested in some of the world's most demanding environments and the R2 design is the compressor of choice by contractors and homeowners in these challenging climates. For the high performance that home-owners demand, R2 rotary compressors are considered by the industry experts.

Leading technology.

Used in over 80% of cooling solutions globally, rotary is the world's dominant residential air conditioning compression technology. Panasonic is the leading rotary and residential AC compressor manufacturer in the world, with over 200 million compressors produced.

Benefits.

Central air conditioning delivered with a Panasonic R2 rotary compressor ensures a superior level of comfort at an economical cost.

Inverter technology

Great energy saving performance. Reduces electricity consumption.

Panasonic Inverter air conditioners are designed to give you exceptional energy savings and performance. At the start up of an air conditioner's operation, a boost in power is required to reach the set temperature. After the set temperature is reached, less power is required to maintain it. The Panasonic Inverter air conditioner varies the rotation speed of the compressor. This provides a highly precise method of maintaining the set temperature.

Constant comfort.

Precise temperature control with a wide power output range enables an Inverter air conditioner to meet different room occupancy levels – thus ensuring constant comfort.

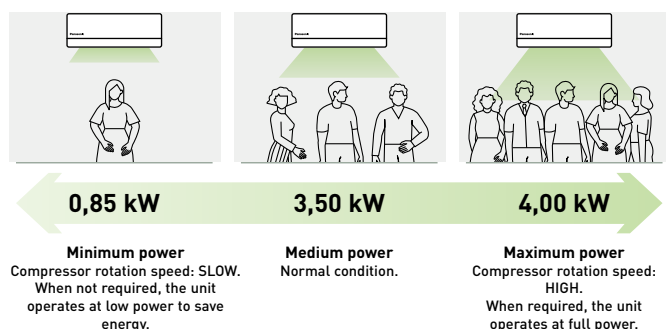

* Graph shows the 3,5 kW Inverter model's wide power output range during cooling.

Quick comfort.

Panasonic Inverter air conditioners can operate with higher power during the start up period to cool the room 1,5 times faster and heat the room 4 times faster than non-Inverter models.

Comparison of cooling speed.

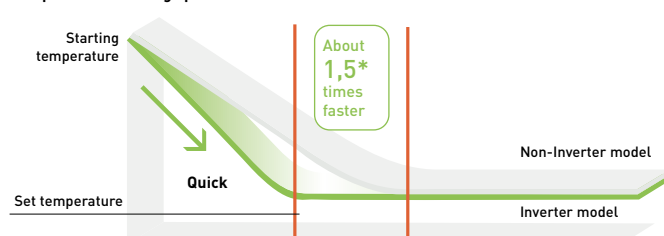

* Comparison of 3,5 kW Inverter vs. non-Inverter. Outside room temperature: 35 °C; setting temperature: 25 °C.

Comparison of heating speed.

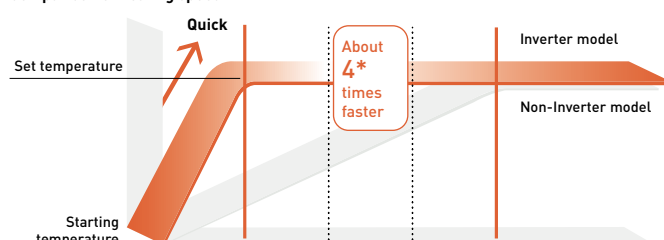

* Comparison of 2,5 kW Inverter vs. non-Inverter. Outside room temperature: 2 °C ; setting temperature: 25 °C.

R22 Renewal. Panasonic standard units can be installed on existing R22 pipings

Change your old air conditioning system to a more efficient system!



An important drive to further reduce the potential damage to our ozone:

- All Panasonic RAC series from NKE to ZKE, including the latest CKE series, can be installed using existing R22 piping
- No need for additional accessories (only pipe reductions)
- Approximately 30% energy savings compared to R22 units

Panasonic is doing its part

We at Panasonic are also doing our part – recognising that all finances are under pressure at the moment. Panasonic has developed a clean and cost effective solution to enable this latest legislation to be introduced with as minimum an effect on businesses and cash reserves as possible.

The Panasonic renewal system allows good quality existing R22 pipe work to be re-used whilst installing new high-efficiency R32 systems.

By bringing a simple solution to the problem Panasonic can renew all Split Systems and PACi NX systems; and depending upon certain restrictions we don't even limit the manufacturer's equipment we are replacing.

By installing a new high-efficiency Panasonic R32 system you can benefit from around 30% running cost saving compared to the R22 system.

Yes...

1. Check the capacity of the system you wish to replace
 2. Select from the Panasonic range the best system to replace it with
 3. Follow the procedure detailed in the brochure and technical data
- Simple...

R22 - The reduction of Chlorine critical for a cleaner future.



Guidance on re-using existing R22 piping for a new R32 installation

1. Precaution.

The existing R22 piping can be re-used for a R32 system installation if the following conditions are met and the piping are finally verified to be:

- Dry (no moisture remaining in the piping)
- Clean (no dust remaining in the piping)
- Tight (no refrigerant leak at the joining and piping)

2. Conditions.

- Recover the refrigerant and oil.
- Operate "force cooling" according to the recommended operation time, regardless of the piping length. Single split: 10 min. Multi split: 30 min. After that, carry out "pump down" to recover the refrigerant and oil from the existing R22 system

* Note: If pump down operation is not possible due to the malfunction of the system, flush and wash the existing piping to collect back the oil and dirt inside the system.

- Check the oil condition. If the oil contains dirt, wash the existing pipes
- Check the oil colour. After pump down, use a cotton bud to wipe the oil from the existing pipe. If the oil colour is higher than ASTM3, use a new pipe as re-use of old piping is not allowed
- Check pipe thickness. Make sure that the pipe thickness is more than 0,8 mm. If the thickness is less than 0,8 mm, use a new pipe
- Rework the flare for R32 connection. Do not reuse the old flare nuts

Deterioration criteria for refrigerant oil.

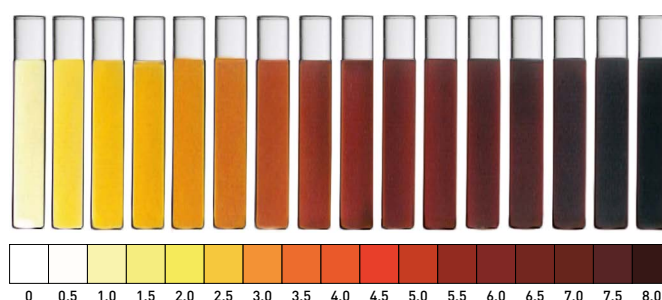

Make sure to use the new flare nuts attached to the R32 system.

* Note: If the existing piping size is 1/4" (6,35 mm) and 1/2" (12,7 mm), and the new R32 system is 1/4" (6,35 mm) and 3/8" (9,52 mm), use a pipe reducer connected at indoor and outdoor unit.

3. Applicable models.

Single split: Panasonic room air conditioners from NKE series onwards, including the latest CKE series.

Multi split: Panasonic room air conditioners from PBE series onwards, including the latest CBE series.

		Liquid		
		Gas	3/8 [9,52]	1/4 [6,35] 1/2 [12,70] 5/8 [15,88]
Split	16 / 20 / 25 / 35	1,6 - 3,5 kW	✓	▲
	42 / 50 / 60	4,2 - 6,0 kW	✗	▲
	71	6,8 - 7,5 kW	✗	✓

✓ Standard piping connection with current piping length and refrigerant charge rules.

▲ This combinations is allowed respecting maximum piping length and refrigerant charged declared in model installed as new.

✗ This combinations is not allowed as it is out of piping diameter.

Panasonic Comfort Cloud App

Take control of your comfort: Manage your Panasonic heat pumps anytime, anywhere.

Now redesigned for a more intuitive and accessible experience.



Comfort Cloud



Effortless multi-device control and monitoring.

Monitor and manage multiple Panasonic units from a single smartphone or tablet. Instantly switch devices on or off, adjust temperature or mode, and activate nanoe™ X.

Whether you're controlling a single unit or coordinating multiple systems, the redesigned app delivers a smart, unified experience for modern living.

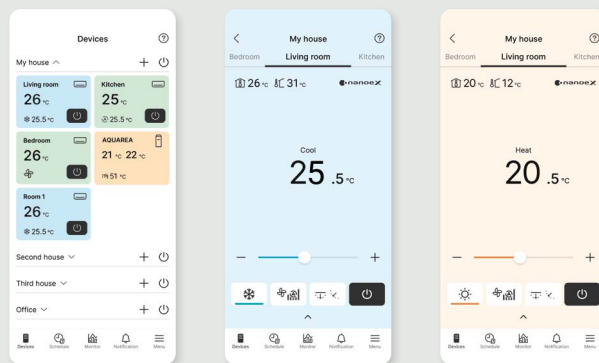

Energy monitoring with statistics.

Track estimated energy use and costs with built-in statistics to support smarter, more efficient living.

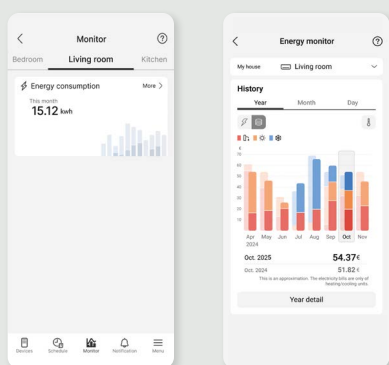

Easy scheduling with weekly timer.

Set timers based on your daily routine to maintain a consistently comfortable environment.

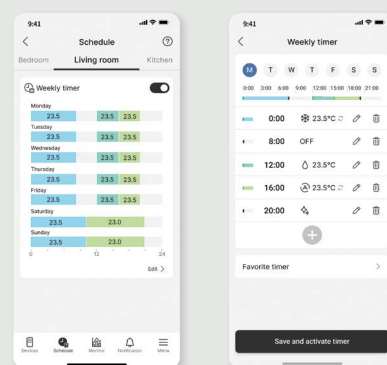

Easier setup with advanced built-in Wi-Fi

The advanced built-in Wi-Fi setup enables secured and easier connection to Panasonic Comfort Cloud App by scanning the QR code*.

* Feature available in models with built-in Wi-Fi.

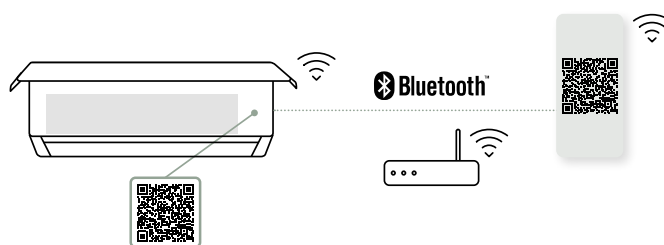

Scan the QR code to enable easier Wi-Fi connectivity to the air conditioner

Requirements for connecting with Panasonic Comfort Cloud App

- 1 | Indoor unit with built-in Wi-Fi: CS-XZ**CKEW-H, CS-XZ**CKEW, CS-MZ16CKE, CS-Z**CKEW, CS-MTZ16CKE, CS-TZ**CKEW, CS-Z**YKEA-1 CS-BZ**CKE, CZ-UZ**CKE, CS-MZ20CFEA and CS-Z**CFEAW
- 2 | Indoor unit with optional CZ-CAPWFC2 Wi-Fi adapter or CONEX remote controller: S-M20PY3E and S-**PY3E

Refer to the user manual for models not listed on this page.

Indoor temperature display and some special functions are not available through the app for all models.

Available in 20 European languages: Bulgarian, Croatian, Czech, Danish, Deutsch, English, Estonian, Finnish, French, Greek, Hungarian, Italian, Norwegian, Polish, Portuguese, Slovenian, Spanish, Swedish, Turkish and Lithuanian.

Panasonic Comfort Cloud App.

Download free app.

Other hardware requirements: Wi-Fi internet connection (not included) and Smartphone or tablet with internet access. The Panasonic Cloud Server is fully managed and operated by Panasonic.



Voice Control. Words do more than actions

Boundless control and hands-free help to access all the features of your air-to-air heat pump.

Maximising your comfort is now a breeze with our connected air conditioners using the Panasonic Comfort Cloud App and Voice Control.



Seamless set up in 3 simple steps

Set up your Panasonic Comfort Cloud App.



Set up your Google Nest Mini or Amazon Echo devices and app.



Link your Google Nest Mini or Amazon Echo with Panasonic Comfort Cloud App.



Compatible devices as of October 2025:

1. Android™ 9 or later
2. iOS 15.6 or later

Please note:

- This is not a definitive list of all compatible devices, other similar devices which use supported Operating Systems should also work either via dedicated apps. Please note that user experience may vary slightly depending on hardware and software combination
- Google, Android™, Google Play and Google Home are trademarks of Google LLC.
- Google Assistant is not available in certain languages and countries
- Amazon, Alexa and all related logos are trademarks of Amazon.com, Inc. or its affiliates
- Availability of Voice Assistant services varies depending on country and language
- Google Assistant and Alexa are compatible with the models shown in pages 28 and 29.



Turn ON / OFF air conditioner

Convenient control for blissful rest.

Turn ON / OFF AC with ease when preparing a comfortable space for your little ones.

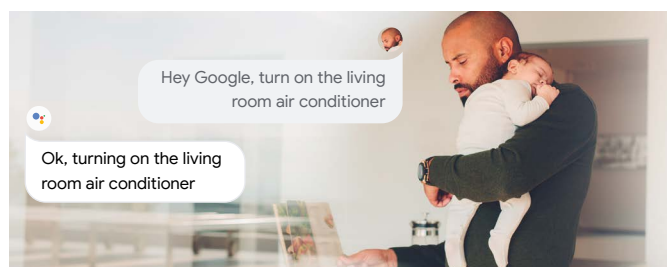

Adjust temperature

Easy control for uninterrupted quality time.

Adjust AC temperature to your comfort with a simple voice command.



Change mode

Extra help when you have a hectic day.

Conveniently change your AC operation mode to cool / heat / auto when your hands are full.



Check current status

Hands-free comfort for the whole family.

Easy access for the elderly to check current AC operation status and adjust AC settings.



Get multiple things done with your voice

Simplify your day with your personalised routine by grouping individual actions.

Schedule your routine with your voice.

With the routine function, you can customise voice commands and control multiple voice-controlled devices including our network-enabled air conditioners to help you with your personalised routine.

Find out more [Amazon]: <https://www.techhive.com/article/3327501/how-to-use-alexa-routines.html>

Example of morning routine.

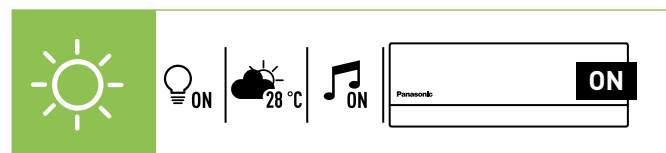

Example of night routine.

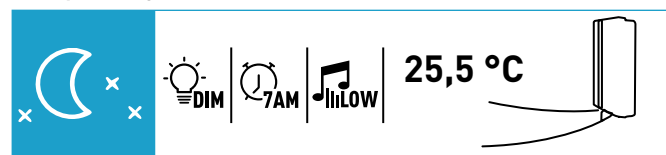

Voice Control with Network-Enabled air conditioners

Functions	When you are home		When away from home
	Remote control	Voice Control	Panasonic Comfort Cloud App
Smart control	Power ON / OFF	✓	✓
	Control multiple units in 1 location	—	✓
	Control multiple units in multiple locations	—	✓
	Set up and manage routines	—	—
Smart comfort	Cooling mode	✓	✓
	Heating mode	✓	✓
	Auto mode	✓	✓
	nanoe™ X mode	✓	✓
	Internal cleaning	✓	✓
	Summer House mode	✓	✓
	Pre-cool	—	✓
	Change temperature	✓	✓
Smart efficiency	Analyse energy usage patterns	—	✓
	Compare historical usage	—	✓
Smart assist	Receive error notifications	—	✓
	Assign multiple users	—	✓
	Check power ON / OFF	✓	✓
	Check temperature settings	✓	✓
	Check room temperature	✓	✓

Control and connectivity

Panasonic offers its customers cutting-edge technology, specially designed to ensure our air conditioning systems deliver even higher performance.

You can properly manage the air conditioning and perform comprehensive monitoring and control, with all of the features the remote controller provides at home, from anywhere in the world thanks to the internet applications Panasonic has created for you.



Domestic integration to S-Link.

CZ-CAPRA1

Can connect RAC range to S-Link. Full control is now possible.

Integrates any unit in big system control.

- YKEA server room integration ¹⁾
- Small offices with domestic indoors
- Tender for refurbishment (old system Domestic and VRF in one installation)
- Centralized Control Systems: 64 indoor units
- Intelligent controller / Web Server: 256 indoor units
- Panasonic AC Smart Cloud

- Basic operation items: ON / OFF, Mode select, Temperature setting, Fan speed, Flap setting, Remote control prohibit
- External input: ON / OFF control signal, Abnormal stop signal
- External output for Relay ²⁾: Operation status (ON / OFF), Alarm status output

1) When duty rotation using the remote controller is set up, CZ-CAPRA1 cannot be connected.
 2) Because current CN-CNT connector can not provide the power for external output relay, additional 12 V DC power supply for external relay is necessary.

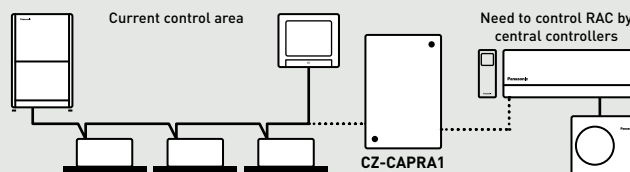

Current system for PACi NX / VRF. Central controller can connect to S-Link line to control units directly.

RAC units cannot connect directly to S-Link to be managed by Central Controllers.

It's necessary to have interface between S-Link and RAC protocol to cover basic operating items.

Control by BMS.

Great flexibility for integration into your KNX, Modbus and BACnet projects allows fully bi-directional monitoring and control of all the functioning parameters.

- Quick Installation
- Direct connection to the unit via CN-CNT connector
- Bidirectional control
- Unit can be controller simultaneously by remote controller and the gateway

1) This interface allows a complete and natural integration of Panasonic air conditioners into either BACnet IP or MS/TP networks. Is a BTL certified device. * For specific functionality list of each gateway, please check the user's manual.

	KNX gateways		Modbus gateways		BACnet gateways	
	PAW-AZAC-KNX-1	PAW-AC-KNX-1i	PAW-AZAC-MBS-1	PAW-AC-MBS-1	PAW-AZAC-BAC-1	PAW-AC-BAC-1
Dimension (H x W x D)	80 x 92 x 22 mm	59 x 45 x 21 mm	80 x 92 x 22 mm	93 x 53 x 59 mm	80 x 92 x 22 mm	93 x 53 x 59 mm
Mounting	Fixed by 2 screws or double-sided adhesive	Not required	Fixed by 2 screws or double-sided adhesive	DIN Rail	Fixed by 2 screws or double-sided adhesive	DIN Rail
Configuration	App and Bluetooth®	DIP switch	App and Bluetooth®	DIP switch	App and Bluetooth®	DIP switch
External power supply	12 V DC	Not required	12 V DC	Not required	12 V DC	Not required

Easy connectivity via CN-CNT port.

All indoor units feature an easily accessible CN-CNT port to integrate accessories such as:









- KNX, Modbus, and BACnet gateways
- CZ-CAPRA1 (centralised control)

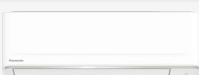

Model name	Interface
CZ-CAPRA1	RAC interface adapter for integration into S-Link, plus external input and alarm/status output
PAW-AC-KNX-1i	KNX gateway powered via CN-CNT. For RAC models with CN-CNT connector
PAW-AZAC-KNX-1	KNX gateway with 12 V DC power supply. For RAC models with CN-CNT connector
PAW-AC-MBS-1	DIN rail-mounted Modbus gateway, powered via CN-CNT. For RAC models with CN-CNT connector

Model name	Interface
PAW-AZAC-MBS-1	Modbus gateway with 12 V DC power supply. For RAC models with CN-CNT connector
PAW-AC-BAC-1	DIN rail-mounted BACnet gateway, powered via CN-CNT. For RAC models with CN-CNT connector
PAW-AZAC-BAC-1	BACnet gateway with 12 V DC power supply. For RAC models with CN-CNT connector
PAW-AC-DIO	Dry contact interface for RAC models with CN-RMT connector

Domestic air conditioner R32 range

Page	Single split units	2,0 kW	2,5 kW	3,5 kW	4,2 kW	5,0 kW	6,0 kW	7,1 kW
NEW! Wall-mounted Etherea · R32								
		CS-XZ20CKEW-H CU-Z20CKE	CS-XZ25CKEW-H CU-Z25CKE	CS-XZ35CKEW-H CU-Z35CKE	CS-XZ42CKEW-H CU-Z42CKE			
P. 30		CS-XZ20CKEW CU-Z20CKE	CS-XZ25CKEW CU-Z25CKE	CS-XZ35CKEW CU-Z35CKE		CS-XZ50CKEW CU-Z50CKE		
		CS-Z20CKEW CU-Z20CKE	CS-Z25CKEW CU-Z25CKE	CS-Z35CKEW CU-Z35CKE	CS-Z42CKEW CU-Z42CKE	CS-Z50CKEW CU-Z50CKE		CS-Z71CKEW CU-Z71CKE
NEW! Wall-mounted TZ super-compact · R32								
P. 31		CS-TZ20CKEW CU-TZ20CKE	CS-TZ25CKEW CU-TZ25CKE	CS-TZ35CKEW CU-TZ35CKE	CS-TZ42CKEW CU-TZ42CKE	CS-TZ50CKEW CU-TZ50CKE	CS-TZ60CKEW CU-TZ60CKE	CS-TZ71CKEW CU-TZ71CKE
NEW! Wall-mounted BZ super-compact · R32								
P. 32			CS-BZ25CKE CU-BZ25CKE	CS-BZ35CKE CU-BZ35CKE		CS-BZ50CKE CU-BZ50CKE	CS-BZ60CKE CU-BZ60CKE	
NEW! Wall-mounted UZ super-compact · R32								
P. 33			CS-UZ25CKE CU-UZ25CKE	CS-UZ35CKE CU-UZ35CKE		CS-UZ50CKE CU-UZ50CKE		
NEW! Floor console · R32								
P. 34			CS-Z25CFEAW CU-Z25CBEA	CS-Z35CFEAW CU-Z35CBEA		CS-Z50CFEAW CU-Z50CBEA		
NEW! Low static pressure hide-away · R32								
P. 35			CS-Z25CD3EAW CU-Z25CBEA	CS-Z35CD3EAW CU-Z35CBEA		CS-Z50CD3EAW CU-Z50CBEA	CS-Z60CD3EAW CU-Z60CBEA	
Page	Stand-alone units	1,7 kW	2,0 kW	2,5 kW	3,0 kW			
RAC Solo · R290 / R32								
P. 43			P-MOG16IC5-E	P-MOZ20IC5-E	P-MOZ25IC5-E			P-MOZ30IC5-E

Try Panasonic's augmented reality tool, the AR Heat Pump Viewer.



Configure your multi split system in a few steps using our online tool and see all possible combinations.

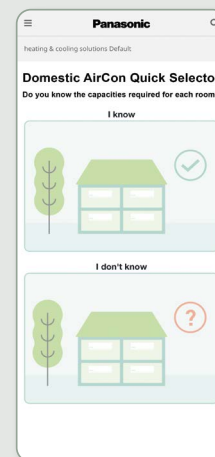

Page	Multi split indoors	1,6 kW	2,0 kW	2,5 kW	3,5 kW	4,2 kW	5,0 kW	6,0 kW	7,1 kW
------	---------------------	--------	--------	--------	--------	--------	--------	--------	--------

NEW! Wall-mounted Etherea

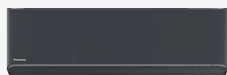

CS-XZ20CKEW-H CS-XZ25CKEW-H CS-XZ35CKEW-H CS-XZ42CKEW-H

P. 39



CS-XZ20CKEW CS-XZ25CKEW CS-XZ35CKEW CS-XZ50CKEW

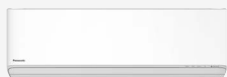

CS-MZ16CKE CS-Z20CKEW CS-Z25CKEW CS-Z35CKEW CS-Z42CKEW CS-Z50CKEW CS-Z71CKEW

NEW! Wall-mounted TZ super-compact

P. 39

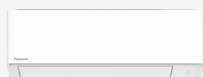

CS-MTZ16CKE CS-TZ20CKEW CS-TZ25CKEW CS-TZ35CKEW CS-TZ42CKEW CS-TZ50CKEW CS-TZ60CKEW CS-TZ71CKEW

NEW! Floor console

P. 39



CS-MZ20CFEA CS-Z25CFEAW CS-Z35CFEAW CS-Z50CFEAW

4 way 60x60 cassette

P. 39



S-M20PY3E CZ-KPY4 S-25PY3E CZ-KPY4 S-36PY3E CZ-KPY4 S-50PY3E CZ-KPY4 S-60PY3E CZ-KPY4

NEW! Low static pressure hide-away

P. 39



CS-MZ20CD3EA CS-Z25CD3EAW CS-Z35CD3EAW CS-Z50CD3EAW CS-Z60CD3EAW

Page	Free Multi	3,2 ~ 6,0 kW	3,2 ~ 6,0 kW	3,2 ~ 7,7 kW	4,5 ~ 9,5 kW	4,5 ~ 11,2 kW	4,5 ~ 11,5 kW	4,5 ~ 14,7 kW	4,5 ~ 18,3 kW
------	------------	--------------	--------------	--------------	--------------	---------------	---------------	---------------	---------------

NEW! Outdoor units Free Multi system - R32

P. 38



CU-2Z35CBE



CU-2Z41CBE



CU-2Z50CBE



CU-3Z52CBE



CU-3Z68CBE



CU-4Z68CBE



CU-4Z80CBE



CU-5Z90CBE

Page	Power Heat Multi	4,0 ~ 8,5 kW (2 room)	4,5 ~ 11,0 kW (3 room)
------	------------------	-----------------------	------------------------

Outdoor units Power Heat Multi system - R32

P. 40



CU-2Z50ABEC



CU-3Z75ABEC

Page	Multi wall TZ	3,2 ~ 6,0 kW	3,2 ~ 7,7 kW	4,5 ~ 9,5 kW
------	---------------	--------------	--------------	--------------

Outdoor units Multi wall TZ system for TZ indoors - R32

P. 41



CU-2TZ41TBE



CU-2TZ50TBE



CU-3TZ52TBE

NEW! Wall-mounted Etherea - R32

- nanoe™ X (Generator Mark 3): Improve protection 24/7
- Internal cleaning: Dries and cleans the indoor with nanoe™ X
- AI ECO Mode: up to 20% energy savings*
- Aerowings 2.0: Enhanced air flow comfort
- Super Quiet at just 19 dB(A)
- Built-in Wi-Fi: Smart control via Comfort Cloud App
- Compatible with Google Assistant and Amazon Alexa
- Optimized design for easy installation
- Graphite grey, silver, or matt white

* In cooling mode.

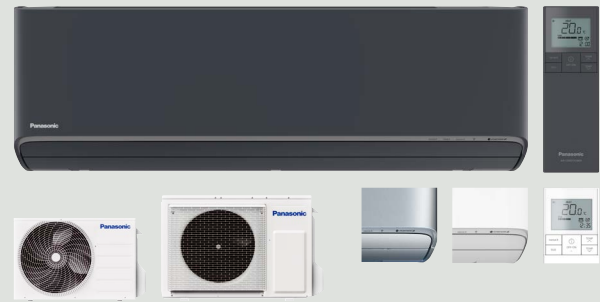

KIT GRAPHITE GREY			KIT-XZ20-CKE-H	KIT-XZ25-CKE-H	KIT-XZ35-CKE-H	KIT-XZ42-CKE-H	—	—
KIT SILVER			KIT-XZ20-CKE	KIT-XZ25-CKE	KIT-XZ35-CKE	—	KIT-XZ50-CKE	—
KIT MATT WHITE			KIT-Z20-CKE	KIT-Z25-CKE	KIT-Z35-CKE	KIT-Z42-CKE	KIT-Z50-CKE	KIT-Z71-CKE
Cooling capacity	Nominal (Min - Max)	kW	2,05 [0,75 - 2,65]	2,50 [0,85 - 3,50]	3,50 [0,85 - 4,20]	4,20 [0,85 - 5,00]	5,00 [0,98 - 6,00]	7,10 [0,98 - 8,50]
EER ¹⁾	Nominal (Min - Max)	W/W	4,66 [4,69 - 4,02]	4,90 [5,00 - 3,89]	4,27 [4,25 - 3,62]	3,39 [3,62 - 3,18]	3,68 [3,92 - 3,16]	3,24 [2,33 - 2,83]
SEER ²⁾			8,70 A+++	9,50 A+++	9,50 A+++	7,10 A++	8,50 A+++	6,50 A++
Pdesign [cooling]		kW	2,1	2,5	3,5	4,2	5,0	7,1
Input power	Nominal (Min - Max)	kW	0,44 [0,16 - 0,66]	0,51 [0,17 - 0,90]	0,82 [0,20 - 1,16]	1,24 [0,24 - 1,57]	1,36 [0,25 - 1,90]	2,19 [0,42 - 3,00]
Annual energy consumption ³⁾		kWh/a	84	92	129	207	206	382
Heating capacity	Nominal (Min - Max)	kW	2,80 [0,75 - 4,00]	3,40 [0,80 - 4,80]	4,00 [0,80 - 5,50]	5,30 [0,80 - 6,80]	5,80 [0,98 - 8,00]	8,20 [0,98 - 10,20]
Heating capacity at -7 °C		kW	2,38	2,8	3,2	4,11	4,8	6,31
COP ¹⁾	Nominal (Min - Max)	W/W	4,67 [4,69 - 4,26]	4,86 [5,00 - 4,07]	4,55 [4,44 - 3,77]	3,73 [4,21 - 3,66]	4,14 [4,26 - 3,35]	3,73 [2,45 - 3,31]
SCOP ²⁾			4,80 A++	5,20 A+++	5,20 A+++	4,30 A+	4,80 A++	4,20 A+
Pdesign at -10 °C		kW	2,4	2,6	2,9	3,6	4,2	5,5
Input power	Nominal (Min - Max)	kW	0,60 [0,16 - 0,94]	0,70 [0,16 - 1,18]	0,88 [0,18 - 1,46]	1,42 [0,19 - 1,86]	1,40 [0,23 - 2,39]	2,20 [0,40 - 3,08]
Annual energy consumption ³⁾		kWh/a	700	700	781	1172	1225	1833
Indoor unit graphite grey			CS-XZ20CKEW-H	CS-XZ25CKEW-H	CS-XZ35CKEW-H	CS-Z42CKEW-H	—	—
Indoor unit silver			CS-XZ20CKEW	CS-XZ25CKEW	CS-XZ35CKEW	—	CS-XZ50CKEW	—
Indoor unit matt white			CS-Z20CKEW	CS-Z25CKEW	CS-Z35CKEW	CS-Z42CKEW	CS-Z50CKEW	CS-Z71CKEW
Power supply		V	230	230	230	230	230	230
Recommended fuse		A	16	16	16	16	16	20
Connection indoor / outdoor		mm ²	4x1,5	4x1,5	4x1,5	4x1,5	4x2,5	4x2,5
Air flow	Cool / Heat	m ³ /min	10,4/11,9	12,4/13,0	12,7/14,4	14,5/15,4	17,4/19,1	19,0/19,9
Moisture removal volume		L/h	1,3	1,5	2	2,4	2,8	4,1
Sound pressure ⁴⁾	Cool (Hi / Lo / Q-Lo)	dB(A)	35/24/19	39/25/19	42/28/19	43/31/25	44/37/30	47/38/30
	Heat (Hi / Lo / Q-Lo)	dB(A)	36/25/19	39/27/19	43/33/19	43/35/29	44/37/30	47/38/30
Dimension	H x W x D	mm	295 x 870 x 229	295 x 870 x 229	295 x 870 x 229	295 x 870 x 229	295 x 1040 x 244	295 x 1040 x 244
Net weight		kg	10	10	11	10	12	13
nanoe X Generator			Mark 3	Mark 3	Mark 3	Mark 3	Mark 3	Mark 3
Outdoor unit			CU-Z20CKE	CU-Z25CKE	CU-Z35CKE	CU-Z42CKE	CU-Z50CKE	CU-Z71CKE
Air flow	Cool / Heat	m ³ /min	26,5/25,7	28,7/26,5	29,8/29,8	29,8/30,9	39,8/36,9	44,7/45,8
Sound pressure ⁴⁾	Cool / Heat (Hi)	dB(A)	45/46	46/47	48/50	49/51	47/47	52/54
Dimension ⁵⁾	H x W x D	mm	542 x 780 x 289	542 x 780 x 289	542 x 780 x 289	542 x 780 x 289	695 x 875 x 320	695 x 875 x 320
Net weight		kg	27	27	31	31	42	45
Piping diameter	Liquid	Inch (mm)	1/4 (6,35)	1/4 (6,35)	1/4 (6,35)	1/4 (6,35)	1/4 (6,35)	1/4 (6,35)
	Gas	Inch (mm)	3/8 (9,52)	3/8 (9,52)	3/8 (9,52)	1/2 (12,70)	1/2 (12,70)	5/8 (15,88)
Pipe length range		m	3-15	3-15	3-15	3-15	3-30	3-30
Elevation difference (in / out)		m	15	15	15	15	15	20
Pre-charged pipe length		m	7,5	7,5	7,5	7,5	7,5	10
Additional gas amount		g/m	10	10	10	10	15	25
Refrigerant (R32) / CO ₂ Eq.		kg / T	0,70/0,47	0,70/0,47	0,81/0,55	0,83/0,56	1,13/0,76	1,35/0,91
Operating range	Cool Min - Max	°C	-10 ~ +43	-10 ~ +43	-10 ~ +43	-10 ~ +43	-10 ~ +43	-10 ~ +43
	Heat Min - Max	°C	-20 ~ +24	-20 ~ +24	-20 ~ +24	-20 ~ +24	-20 ~ +24	-20 ~ +24

1) EER and COP calculation is based in accordance to EN 14511. 2) Energy Label Scale from A+++ to D. 3) The annual energy consumption is calculated in accordance to EU/626/2011. 4) The sound pressure of the indoor unit shows the value measured at a position of 1 m in front of the main body and 0,8 m below the unit. For outdoor unit 1 m in front and 1 m in rear side of main body. The sound pressure is measured in accordance with JIS C 9612. Q-Lo: Quiet mode. Lo: The lowest set fan speed. 5) Add 70 mm for piping port.

Accessories

CZ-CAPRA1 RAC interface adapter for integration into S-Link

Accessories

CZ-RD517C Wired remote controller for wall-mounted and floor console

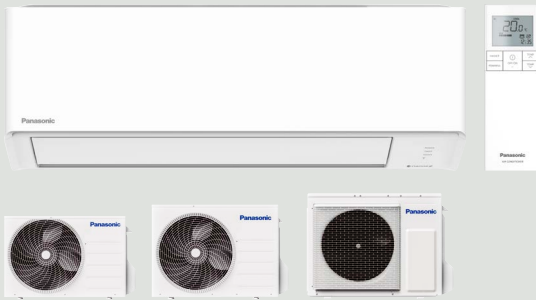

SEER and SCOP: For KIT-**25-CKE and KIT-**35-CKE. AI ECO MODE: In cooling mode. SUPER QUIET: For KIT-**20-CKE, KIT-**25-CKE and KIT-**35-CKE. INTERNET CONTROL: Built-in Wi-Fi.

NEW! Wall-mounted TZ super-compact · R32

- nanoe™ X (Generator Mark 2): Improve protection 24/7
- Aerowings: Enhanced air flow comfort
- Super Quiet at just 20 dB(A)
- Built-in Wi-Fi: Smart control via Comfort Cloud App
- Compatible with Google Assistant and Amazon Alexa
- Elegant and space saving design, only 765 mm wide
- Optimized design for easy installation 2.0

KIT			KIT-TZ20-CKE	KIT-TZ25-CKE	KIT-TZ35-CKE	KIT-TZ42-CKE	KIT-TZ50-CKE	KIT-TZ60-CKE	KIT-TZ71-CKE
Cooling capacity	Nominal (Min - Max)	kW	2,00(0,75-2,50)	2,50(0,85-3,00)	3,50(0,85-4,00)	4,20(0,85-4,60)	5,00(0,98-5,60)	6,00(0,98-6,60)	7,10(0,98-8,40)
EER ¹⁾	Nominal (Min - Max)	W/W	4,08(4,17-3,91)	3,85(4,05-3,41)	3,57(3,62-3,33)	3,36(3,62-2,80)	3,13(3,92-2,96)	3,24(3,92-2,87)	3,23(2,33-2,80)
SEER ²⁾			7,00A++	7,30A++	7,30A++	6,60A++	6,90A++	6,90A++	6,30A++
Pdesign (cooling)		kW	2,0	2,5	3,5	4,2	5,0	6,0	7,1
Input power	Nominal (Min - Max)	kW	0,49(0,18-0,64)	0,65(0,21-0,88)	0,98(0,24-1,20)	1,25(0,24-1,64)	1,60(0,25-1,89)	1,85(0,25-2,30)	2,20(0,42-3,00)
Annual energy consumption ³⁾		kWh/a	100	120	168	223	254	304	394
Heating capacity	Nominal (Min - Max)	kW	2,70(0,70-3,60)	3,30(0,80-4,10)	4,00(0,80-5,10)	5,00(0,80-6,80)	5,80(0,98-7,50)	7,00(0,98-8,20)	8,20(0,98-10,20)
Heating capacity at -7 °C		kW	2,35	2,70	3,30	3,90	4,62	4,90	6,31
COP ¹⁾	Nominal (Min - Max)	W/W	4,15(4,24-3,53)	4,18(4,21-3,66)	4,04(4,10-3,70)	3,73(4,10-3,33)	3,41(4,67-3,26)	3,72(4,67-3,57)	3,71(2,45-3,29)
SCOP ²⁾			4,60A++	4,60A++	4,60A++	4,10A+	4,50A+	4,30A+	4,10A+
Pdesign at -10 °C		kW	2,1	2,4	2,8	3,6	4,0	4,4	5,5
Input power	Nominal (Min - Max)	kW	0,65(0,17-1,02)	0,79(0,19-1,12)	0,99(0,20-1,38)	1,34(0,20-2,04)	1,70(0,21-2,30)	1,88(0,21-2,30)	2,21(0,40-3,10)
Annual energy consumption ³⁾		kWh/a	639	730	852	1229	1244	1433	1878
Indoor unit			CS-TZ20CKEW	CS-TZ25CKEW	CS-TZ35CKEW	CS-TZ42CKEW	CS-TZ50CKEW	CS-TZ60CKEW	CS-TZ71CKEW
Power supply		V	230	230	230	230	230	230	230
Recommended fuse		A	16	16	16	16	16	20	20
Connection indoor / outdoor		mm ²	4x1,5	4x1,5	4x1,5	4x1,5	4x2,5	4x2,5	4x2,5
Air flow	Cool / Heat	m ³ /min	10,0/10,5	11,0/11,5	11,8/12,3	12,6/13,3	12,6/13,4	19,9/21,0	20,4/21,6
Moisture removal volume		L/h	1,3	1,5	2	2,4	2,8	3,3	4,1
Sound pressure ⁴⁾	Cool (Hi / Lo / Q-Lo)	dB(A)	37/25/20	40/26/20	42/30/20	44/31/25	44/37/33	45/37/34	47/38/35
	Heat (Hi / Lo / Q-Lo)	dB(A)	38/26/21	40/27/21	42/33/21	44/35/28	44/37/33	45/37/34	47/38/35
Dimension	H x W x D	mm	290 x 765 x 214	290 x 765 x 214	290 x 765 x 214	290 x 765 x 214	290 x 765 x 214	295 x 1060 x 249	295 x 1060 x 249
Net weight		kg	9	9	9	9	9	14	15
nanoe X Generator			Mark 2	Mark 2	Mark 2	Mark 2	Mark 2	Mark 2	Mark 2
Outdoor unit			CU-TZ20CKE	CU-TZ25CKE	CU-TZ35CKE	CU-TZ42CKE	CU-TZ50CKE	CU-TZ60CKE	CU-TZ71CKE
Air flow	Cool / Heat	m ³ /min	29,7/29,7	30,0/28,9	28,7/29,7	31,0/29,5	32,7/32,7	34,4/35,6	44,7/45,8
Sound pressure ⁴⁾	Cool / Heat (Hi)	dB(A)	46/47	47/48	48/50	49/51	48/49	49/51	52/54
Dimension ⁵⁾	H x W x D	mm	542 x 780 x 289	542 x 780 x 289	542 x 780 x 289	542 x 780 x 289	619 x 824 x 299	619 x 824 x 299	695 x 875 x 320
Net weight		kg	24	25	30	31	35	36	45
Piping diameter	Liquid	Inch (mm)	1/4(6,35)	1/4(6,35)	1/4(6,35)	1/4(6,35)	1/4(6,35)	1/4(6,35)	1/4(6,35)
	Gas	Inch (mm)	3/8(9,52)	3/8(9,52)	3/8(9,52)	1/2(12,70)	1/2(12,70)	1/2(12,70)	5/8(15,88)
Pipe length range		m	3-15	3-15	3-15	3-15	3-20	3-30	3-30
Elevation difference (in / out)		m	15	15	15	15	15	15	20
Pre-charged pipe length		m	7,5	7,5	7,5	7,5	10	10	10
Additional gas amount		g/m	10	10	10	10	15	15	25
Refrigerant (R32) / CO ₂ Eq.		kg / T	0,50/0,34	0,58/0,39	0,68/0,46	0,79/0,53	1,03/0,70	1,22/0,82	1,32/0,89
Operating range	Cool Min ~ Max	°C	-10 ~ +43	-10 ~ +43	-10 ~ +43	-10 ~ +43	-10 ~ +43	-10 ~ +43	-10 ~ +43
	Heat Min ~ Max	°C	-15 ~ +24	-15 ~ +24	-15 ~ +24	-15 ~ +24	-15 ~ +24	-15 ~ +24	-15 ~ +24

1) EER and COP calculation is based in accordance to EN 14511. 2) Energy Label Scale from A+++ to D. 3) The annual energy consumption is calculated in accordance to EU/626/2011. 4) The sound pressure of the indoor unit shows the value measured of a position of 1 m in front of the main body and 0,8 m below the unit. For outdoor unit 1 m in front and 1 m in rear side of main body. The sound pressure is measured in accordance with JIS C 9612. Q-Lo: Quiet mode. Lo: The lowest set fan speed. 5) Add 70 mm for piping port.

Accessories
CZ-CAPRA1 RAC interface adapter for integration into S-Link

Accessories
CZ-RD517C Wired remote controller for wall-mounted and floor console

SEER and SCOP: For KIT-TZ25-CKE and KIT-TZ35-CKE. **SUPER QUIET:** For KIT-TZ20-CKE, KIT-TZ25-CKE and KIT-TZ35-CKE. **INTERNET CONTROL:** Built-in Wi-Fi.

Rating conditions: Cooling indoor 27 °C DB / 19 °C WB. Cooling outdoor 35 °C DB / 24 °C WB. Heating indoor 20 °C DB. Heating outdoor 7 °C DB / 6 °C WB. (DB: Dry Bulb, WB: Wet Bulb). Specifications subject to change without notice. For detailed information about ErP / Energy Labelling, please visit our websites www.aircon.panasonic.eu or www.ptc.panasonic.eu.

NEW! Wall-mounted BZ super-compact - R32

- Space saving design, only 765 mm wide
- Cleaner indoor air with PM2,5 Filter
- Aerowings: Enhanced air flow comfort
- Super Quiet at just 20 dB(A)
- Built-in Wi-Fi: Smart control via Comfort Cloud App
- Compatible with Google Assistant and Amazon Alexa
- Optimized design for easy installation 2.0

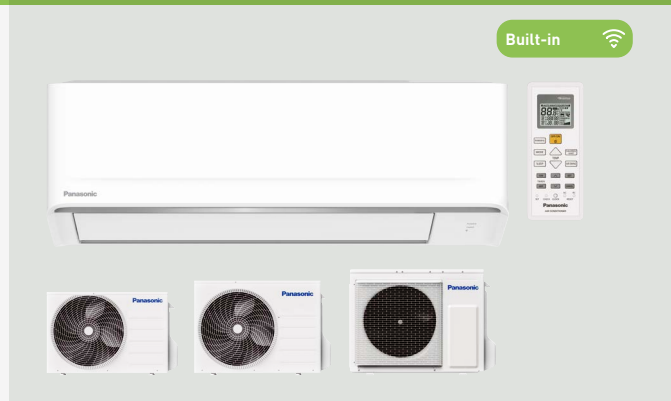

KIT			KIT-BZ25-CKE	KIT-BZ35-CKE	KIT-BZ50-CKE	KIT-BZ60-CKE
Cooling capacity	Nominal (Min - Max)	kW	2,50 (0,85 - 3,00)	3,30 (0,85 - 3,90)	5,00 (0,98 - 5,40)	6,00 (0,98 - 6,50)
EER ¹⁾	Nominal (Min - Max)	W/W	3,68 (4,05 - 3,33)	3,24 (3,54 - 3,05)	3,03 (3,92 - 2,90)	3,03 (3,92 - 2,83)
SEER ²⁾			6,50 A++	6,50 A++	6,60 A++	6,40 A++
Pdesign (cooling)		kW	2,5	3,3	5	6
Input power	Nominal (Min - Max)	kW	0,68 (0,21 - 0,90)	1,02 (0,24 - 1,28)	1,65 (0,25 - 1,86)	1,98 (0,25 - 2,30)
Annual energy consumption ³⁾		kWh/a	135	178	265	328
Heating capacity	Nominal (Min - Max)	kW	3,15 (0,80 - 3,60)	3,70 (0,80 - 4,40)	5,40 (0,98 - 7,50)	6,80 (0,98 - 8,00)
Heating capacity at -7 °C		kW	2,35	2,60	4,62	5,19
COP ¹⁾	Nominal (Min - Max)	W/W	4,09 (4,21 - 3,50)	3,72 (4,10 - 3,49)	3,42 (4,67 - 3,09)	3,16 (4,26 - 3,02)
SCOP ²⁾			4,40 A+	4,20 A+	4,20 A+	4,10 A+
Pdesign at -10 °C		kW	2,1	2,4	4	4,4
Input power	Nominal (Min - Max)	kW	0,77 (0,19 - 1,03)	1,00 (0,20 - 1,26)	1,58 (0,21 - 2,43)	2,15 (0,23 - 2,65)
Annual energy consumption ³⁾		kWh/a	668	800	1333	1502
Indoor unit			CS-BZ25CKE	CS-BZ35CKE	CS-BZ50CKE	CS-BZ60CKE
Power supply		V	230	230	230	230
Recommended fuse		A	16	16	16	20
Connection indoor / outdoor		mm ²	4x1,5	4x1,5	4x2,5	4x2,5
Air flow	Cool / Heat	m ³ /min	10,0/10,5	10,4/11,4	12,6/13,4	12,8/13,1
Moisture removal volume		L/h	1,5	1,9	2,8	3,3
Sound pressure ⁴⁾	Cool (Hi / Lo / Q-Lo)	dB(A)	37/26/20	38/30/20	44/37/34	45/37/34
	Heat (Hi / Lo / Q-Lo)	dB(A)	36/27/24	38/33/25	44/37/34	45/37/34
Dimension	H x W x D	mm	290 x 765 x 214	290 x 765 x 214	290 x 765 x 214	290 x 765 x 214
Net weight		kg	9	9	9	9
Outdoor unit			CU-BZ25CKE	CU-BZ35CKE	CU-BZ50CKE	CU-BZ60CKE
Air flow	Cool / Heat	m ³ /min	30,4/30,4	31,1/30,4	32,7/32,7	42,6/39,2
Sound pressure ⁴⁾	Cool / Heat (Hi)	dB(A)	48/49	48/50	48/49	50/50
Dimension ⁵⁾	H x W x D	mm	542 x 780 x 289	542 x 780 x 289	619 x 824 x 299	695 x 875 x 320
Net weight		kg	24	25	35	42
Piping diameter	Liquid	Inch (mm)	1/4 (6,35)	1/4 (6,35)	1/4 (6,35)	1/4 (6,35)
	Gas	Inch (mm)	3/8 (9,52)	3/8 (9,52)	1/2 (12,70)	1/2 (12,70)
Pipe length range		m	3 - 15	3 - 15	3 - 15	3 - 30
Elevation difference (in / out)		m	15	15	15	15
Pre-charged pipe length		m	7,5	7,5	10	7,5
Additional gas amount		g/m	10	10	15	15
Refrigerant (R32) / CO ₂ Eq.		kg / T	0,50/0,34	0,56/0,38	1,03/0,70	1,03/0,70
Operating range	Cool Min ~ Max	°C	-10 ~ +43	-10 ~ +43	-10 ~ +43	-10 ~ +43
	Heat Min ~ Max	°C	-15 ~ +24	-15 ~ +24	-15 ~ +24	-15 ~ +24

1) EER and COP calculation is based in accordance to EN 14511. 2) Energy Label Scale from A+++ to D. 3) The annual energy consumption is calculated in accordance to EU/626/2011. 4) The sound pressure of the indoor unit shows the value measured at a position of 1 m in front of the main body and 0,8 m below the unit. For outdoor unit 1 m in front and 1 m in rear side of main body. The sound pressure is measured in accordance with JIS C 9612. Q-Lo: Quiet mode. Lo: The lowest set fan speed. 5) Add 70 mm for piping port.

Accessories

CZ-CAPRA1 RAC interface adapter for integration into S-Link

Accessories

CZ-RD517C Wired remote controller for wall-mounted and floor console

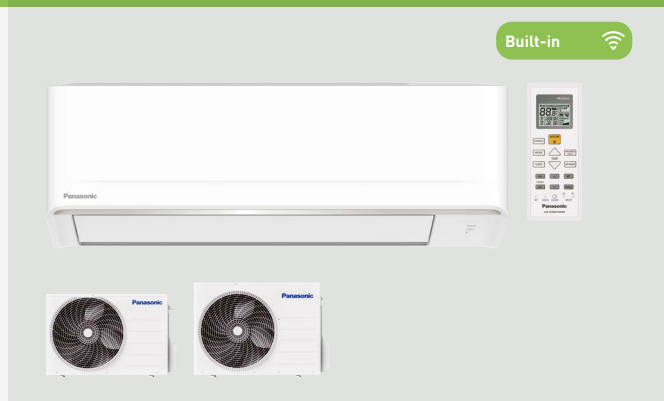

SEER: For KIT-BZ50-CKE. SCOP: For KIT-BZ25-CKE. SUPER QUIET: For KIT-BZ25-CKE and KIT-BZ35-CKE. INTERNET CONTROL: Built-in Wi-Fi.

**NEW! Wall-mounted UZ super-compact - R32**

- Space saving design, only 765 mm wide
- Aerowings: Enhanced air flow comfort
- Super Quiet at just 20 dB(A)
- Built-in Wi-Fi: Smart control via Comfort Cloud App
- Compatible with Google Assistant and Amazon Alexa
- Optimized design for easy installation 2.0

KIT			KIT-UZ25-CKE	KIT-UZ35-CKE	KIT-UZ50-CKE
Cooling capacity	Nominal (Min - Max)	kW	2,50 (0,85 - 3,00)	3,30 (0,85 - 3,90)	5,00 (0,98 - 5,40)
EER ¹⁾	Nominal (Min - Max)	W/W	3,68 (4,05 - 3,33)	3,24 (3,54 - 3,00)	3,03 (3,92 - 2,89)
SEER ²⁾			6,40 A++	6,40 A++	6,60 A++
Pdesign (cooling)		kW	2,5	3,3	5
Input power	Nominal (Min - Max)	kW	0,68 (0,21 - 0,90)	1,02 (0,24 - 1,30)	1,65 (0,25 - 1,87)
Annual energy consumption ³⁾		kWh/a	137	180	265
Heating capacity	Nominal (Min - Max)	kW	3,15 (0,80 - 3,60)	3,70 (0,80 - 4,40)	5,40 (0,98 - 7,40)
Heating capacity at -7 °C		kW	2,35	2,60	4,52
COP ¹⁾	Nominal (Min - Max)	W/W	4,06 (4,21 - 3,50)	3,72 (4,10 - 3,46)	3,42 (4,67 - 3,08)
SCOP ²⁾			4,30 A+	4,10 A+	4,10 A+
Pdesign at -10 °C		kW	2,1	2,4	4
Input power	Nominal (Min - Max)	kW	0,78 (0,19 - 1,03)	1,00 (0,20 - 1,27)	1,58 (0,21 - 2,40)
Annual energy consumption ³⁾		kWh/a	684	820	1366
Indoor unit			CS-UZ25CKE	CS-UZ35CKE	CS-UZ50CKE
Power supply		V	230	230	230
Recommended fuse		A	16	16	16
Connection indoor / outdoor		mm ²	4x1,5	4x1,5	4x2,5
Air flow	Cool / Heat	m ³ /min	10,0/10,5	10,4/11,4	12,6/13,4
Moisture removal volume		L/h	1,5	1,9	2,8
Sound pressure ⁴⁾	Cool (Hi / Lo / Q-Lo)	dB(A)	37/26/20	38/30/20	44/37/34
	Heat (Hi / Lo / Q-Lo)	dB(A)	36/27/24	38/33/25	44/37/34
Dimension	H x W x D	mm	290 x 765 x 214	290 x 765 x 214	290 x 765 x 214
Net weight		kg	9	9	9
Outdoor unit			CU-UZ25CKE	CU-UZ35CKE	CU-UZ50CKE
Air flow	Cool / Heat	m ³ /min	30,4/30,4	31,1/30,4	32,7/32,7
Sound pressure ⁴⁾	Cool / Heat (Hi)	dB(A)	48/49	48/50	48/49
Dimension ⁵⁾	H x W x D	mm	542 x 780 x 289	542 x 780 x 289	619 x 824 x 299
Net weight		kg	24	25	35
Piping diameter	Liquid	Inch (mm)	1/4 (6,35)	1/4 (6,35)	1/4 (6,35)
	Gas	Inch (mm)	3/8 (9,52)	3/8 (9,52)	1/2 (12,70)
Pipe length range		m	3 ~ 15	3 ~ 15	3 ~ 15
Elevation difference (in / out)		m	15	15	15
Pre-charged pipe length		m	7,5	7,5	10
Additional gas amount		g/m	10	10	15
Refrigerant (R32) / CO ₂ Eq.		kg / T	0,50/0,34	0,56/0,38	1,03/0,70
Operating range	Cool Min ~ Max	°C	-10 ~ +43	-10 ~ +43	-10 ~ +43
	Heat Min ~ Max	°C	-15 ~ +24	-15 ~ +24	-15 ~ +24

1) EER and COP calculation is based in accordance to EN 14511. 2) Energy Label Scale from A+++ to D. 3) The annual energy consumption is calculated in accordance to EU/626/2011. 4) The sound pressure of the indoor unit shows the value measured of a position of 1 m in front of the main body and 0,8 m below the unit. For outdoor unit 1 m in front and 1 m in rear side of main body. The sound pressure is measured in accordance with JIS C 9612. Q-Lo: Quiet mode. Lo: The lowest set fan speed. 5) Add 70 mm for piping port.

Accessories

CZ-CAPRA1 RAC interface adapter for integration into S-Link

Accessories

CZ-RD517C Wired remote controller for wall-mounted and floor console



SEER: For KIT-UZ50-CKE. SCOP: For KIT-UZ25-CKE. SUPER QUIET: For KIT-UZ25-CKE and KIT-UZ35-CKE. INTERNET CONTROL: Built-in Wi-Fi.

Rating conditions: Cooling indoor 27 °C DB / 19 °C WB. Cooling outdoor 35 °C DB / 24 °C WB. Heating indoor 20 °C DB. Heating outdoor 7 °C DB / 6 °C WB. (DB: Dry Bulb; WB: Wet Bulb). Specifications subject to change without notice. For detailed information about ErP / Energy Labelling, please visit our websites www.aircon.panasonic.eu or www.ptc.panasonic.eu.

NEW! Floor console - R32

- nanoe™ X (Generator Mark 3): Improve protection 24/7
- Modern design: Seamlessly integrates into contemporary interiors
- Stylish remote control
- Built-in Wi-Fi: Smart control via Comfort Cloud App
- Compatible with Google Assistant and Amazon Alexa

Built-in



KIT			KIT-Z25-CFE	KIT-Z35-CFE	KIT-Z50-CFE
Cooling capacity	Nominal (Min - Max)	kW	2,50 (0,85 - 3,40)	3,50 (0,85 - 3,80)	5,00 (0,90 - 5,70)
EER ¹⁾	Nominal (Min - Max)	W/W	4,81 (3,54 - 3,78)	4,07 (3,54 - 3,73)	3,60 (3,53 - 3,15)
SEER ²⁾			7,90 A++	8,10 A++	6,70 A++
Pdesign (cooling)		kW	2,50	3,50	5,00
Input power	Nominal (Min - Max)	kW	0,52 (0,24 - 0,90)	0,86 (0,24 - 1,02)	1,39 (0,26 - 1,81)
Annual energy consumption ³⁾		kWh/a	111	151	261
Heating capacity	Nominal (Min - Max)	kW	3,40 (0,85 - 5,00)	4,30 (0,85 - 6,00)	5,80 (0,90 - 8,10)
Heating capacity at -7 °C		kW	2,88	3,37	5,03
COP ¹⁾	Nominal (Min - Max)	W/W	4,47 (3,54 - 3,70)	3,98 (3,54 - 3,43)	3,74 (3,46 - 3,12)
SCOP ²⁾			4,60 A++	4,60 A++	4,30 A+
Pdesign at -10 °C		kW	2,70	3,20	4,40
Input power	Nominal (Min - Max)	kW	0,76 (0,24 - 1,35)	1,08 (0,24 - 1,75)	1,55 (0,26 - 2,60)
Annual energy consumption ³⁾		kWh/a	822	974	1433
Indoor unit			CS-Z25CFEAW	CS-Z35CFEAW	CS-Z50CFEAW
Air flow	Cool / Heat	m ³ /min	9,6/10,0	9,7/10,1	11,9/13,4
Moisture removal volume		L/h	1,5	2,0	2,8
Sound pressure ⁴⁾	Cool (Hi / Lo / Q-Lo)	dB(A)	38/25/20	39/26/20	44/31/27
	Heat (Hi / Lo / Q-Lo)	dB(A)	38/25/19	39/26/19	46/33/29
Dimension	HxWxD	mm	600x750x207	600x750x207	600x750x207
Net weight		kg	13	13	13
nanoe X Generator			Mark 3	Mark 3	Mark 3
Outdoor unit			CU-Z25CBEA	CU-Z35CBEA	CU-Z50CBEA
Power supply		V	230	230	230
Recommended fuse		A	16	16	16
Connection indoor / outdoor		mm ²	4x1,5	4x1,5	4x1,5
Air flow	Cool / Heat	m ³ /min	28,7/27,2	34,3/31,8	39,7/36,4
Sound pressure ⁴⁾	Cool / Heat (Hi)	dB(A)	46/47	48/48	48/48
Dimension ⁵⁾	HxWxD	mm	542x780x289	619x824x299	695x875x320
Net weight		kg	32	33	43
Piping diameter	Liquid	Inch (mm)	1/4 (6,35)	1/4 (6,35)	1/4 (6,35)
	Gas	Inch (mm)	3/8 (9,52)	3/8 (9,52)	1/2 (12,70)
Pipe length range		m	3 - 20	3 - 20	3 - 30
Elevation difference (in / out)		m	15	15	20
Pre-charged pipe length		m	7,5	7,5	7,5
Additional gas amount		g/m	10	10	15
Refrigerant (R32) / CO ₂ Eq.		kg / T	0,88 / 0,59	0,97 / 0,65	1,13 / 0,76
Operating range	Cool Min ~ Max	°C	-10 ~ +43	-10 ~ +43	-10 ~ +43
	Heat Min ~ Max	°C	-15 ~ +24	-15 ~ +24	-15 ~ +24

1) EER and COP calculation is based in accordance to EN 14511. 2) Energy Label Scale from A+++ to D. 3) The annual energy consumption is calculated in accordance to EU/626/2011. 4) The sound pressure of the units shows the value measured of a position 1 m in front of the main body and 1 m above floor. The sound pressure is measured in accordance with JIS C 9612. Q-Lo: Quiet mode. Lo: The lowest set fan speed. 5) Add 70 mm for piping port.

Accessories
CZ-CAPRA1 RAC interface adapter for integration into S-Link
Accessories
CZ-RD517C Wired remote controller for wall-mounted and floor console

SEER and SCOP: For KIT-Z35-CFE. SUPER QUIET: For KIT-Z25-CFE and KIT-Z35-CFE. INTERNET CONTROL: Built-in Wi-Fi. iF DESIGN AWARD 2019: Floor console awarded with the prestigious iF Design Award 2019.

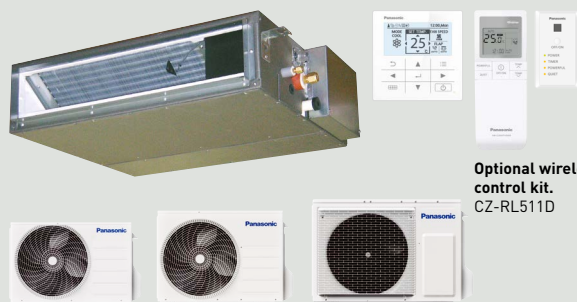

Optional wireless control kit. CZ-RL511D

NEW! Low static pressure hide-away - R32

- Compact design: Indoor unit only 200 mm high
- Flexible installation: Long piping, compact outdoor unit, air inlet from the back or bottom
- Built-in drain pump
- Optional KNX, Modbus, and BACnet connectivity
- Wired control with weekly timer

MORE DUCT TYPE SOLUTIONS IN PACI NX SECTION

KIT			KIT-Z25-CD3	KIT-Z35-CD3	KIT-Z50-CD3	KIT-Z60-CD3
Cooling capacity	Nominal (Min - Max)	kW	2,50 [0,85 - 3,20]	3,50 [0,85 - 4,00]	5,10 [0,90 - 5,70]	6,00 [0,90 - 6,50]
EER ¹⁾	Nominal (Min - Max)	W/W	4,31 [3,54 - 3,76]	3,85 [3,54 - 3,36]	3,27 [3,53 - 3,20]	2,94 [3,53 - 2,83]
SEER ²⁾			6,20 A++	6,20 A++	6,10 A++	6,00 A+
P _{design} (cooling)		kW	2,50	3,50	5,10	6,00
Input power	Nominal (Min - Max)	kW	0,58 [0,24 - 0,85]	0,91 [0,24 - 1,19]	1,56 [0,26 - 1,78]	2,04 [0,26 - 2,30]
Annual energy consumption ³⁾		kWh/a	141	198	293	350
Heating capacity	Nominal (Min - Max)	kW	3,20 [0,85 - 4,60]	4,20 [0,85 - 5,10]	6,10 [0,90 - 7,20]	7,00 [0,90 - 8,00]
Heating capacity at -7 °C		kW	2,60	3,00	4,50	5,10
COP ¹⁾	Nominal (Min - Max)	W/W	4,00 [3,70 - 3,68]	3,82 [3,70 - 3,59]	3,35 [3,46 - 3,27]	3,24 [3,46 - 3,08]
SCOP ²⁾			4,20 A+	4,10 A+	4,10 A+	4,10 A+
P _{design} at -10 °C		kW	2,60	2,80	4,00	4,60
Input power	Nominal (Min - Max)	kW	0,80 [0,23 - 1,25]	1,10 [0,23 - 1,42]	1,82 [0,26 - 2,20]	2,16 [0,26 - 2,60]
Annual energy consumption ³⁾		kWh/a	867	956	1366	1571
Indoor unit			CS-Z25CD3EAW	CS-Z35CD3EAW	CS-Z50CD3EAW	CS-Z60CD3EAW
External static pressure ⁴⁾	Min - Max	Pa	15 - 45	15 - 45	15 - 50	15 - 50
Air flow	Cool / Heat	m ³ /min	10,5/10,5	11,2/11,2	15,3/15,3	15,7/15,7
Moisture removal volume		L/h	1,5	2,0	2,8	2,8
Sound pressure ⁵⁾	Cool (Hi / Lo / Q-Lo)	dB(A)	33/27/24	33/27/24	39/29/26	41/30/27
	Heat (Hi / Lo / Q-Lo)	dB(A)	35/27/24	35/27/24	39/30/27	41/32/29
Dimension	H x W x D	mm	200 x 750 x 640	200 x 750 x 640	200 x 750 x 640	200 x 750 x 640
Net weight		kg	19	19	19	19
Outdoor unit			CU-Z25CBEA	CU-Z35CBEA	CU-Z50CBEA	CU-Z60CBEA
Power supply		V	230	230	230	230
Recommended fuse		A	16	16	16	—
Connection indoor / outdoor		mm ²	4x1,5~2,5	4x1,5~2,5	4x1,5~2,5	—
Air flow	Cool / Heat	m ³ /min	28,7/27,2	34,3/31,8	39,7/36,4	42,6/39,7
Sound pressure ⁵⁾	Cool / Heat (Hi)	dB(A)	46/47	48/48	48/48	49/50
Dimension ⁶⁾	H x W x D	mm	542 x 780 x 289	619 x 824 x 299	695 x 875 x 320	695 x 875 x 320
Net weight		kg	32	33	43	43
Piping diameter	Liquid	Inch (mm)	1/4 (6,35)	1/4 (6,35)	1/4 (6,35)	1/4 (6,35)
	Gas	Inch (mm)	3/8 (9,52)	3/8 (9,52)	1/2 (12,70)	1/2 (12,70)
Pipe length range		m	3~20	3~20	3~30	3~30
Elevation difference (in / out)		m	15	15	20	20
Pre-charged pipe length		m	7,5	7,5	7,5	7,5
Additional gas amount		g/m	10	10	15	15
Refrigerant (R32) / CO ₂ Eq.		kg / T	0,88/0,59	0,97/0,65	1,13/0,76	1,13/0,76
Operating range	Cool Min ~ Max	°C	-10 ~ +43	-10 ~ +43	-10 ~ +43	-10 ~ +43
	Heat Min ~ Max	°C	-15 ~ +24	-15 ~ +24	-15 ~ +24	-15 ~ +24

1) EER and COP calculation is based in accordance to EN 14511. 2) Energy Label Scale from A+++ to D. 3) The annual energy consumption is calculated in accordance to EU/626/2011. 4) The specification listed on the table indicates values under the condition of 25 Pa (2,5 mmAq) which are applied for factory default setting. Change switch on PCB from Hi to S-Hi to have more than 6,0 mmAq. 5) The sound pressure of the indoor unit shows the value measured of a position of 1,5 m below the unit with 1 m duct on the suction side and 2 m duct on the discharge side. For outdoor unit 1 m in front and 1 m in rear side of main body. The sound pressure is measured in accordance with JIS C 9612. 6) Add 100 mm for indoor unit or 70 mm for outdoor unit for piping port.

Accessories

CZ-CAPRA1 RAC interface adapter for integration into S-Link

Accessories

CZ-RL511D Optional wireless control kit



SEER and SCOP: For KIT-Z25-CD3.

Rating conditions: Cooling indoor 27 °C DB / 19 °C WB. Cooling outdoor 35 °C DB / 24 °C WB. Heating indoor 20 °C DB. Heating outdoor 7 °C DB / 6 °C WB. (DB: Dry Bulb; WB: Wet Bulb). Specifications subject to change without notice. For detailed information about ErP / Energy Labelling, please visit our websites www.aircon.panasonic.eu or www.ptc.panasonic.eu.

Multi split systems

When the heating and cooling requirements exceed the scope of a single room, Panasonic offers a wide range of options with a multi split solution.



Panasonic multi split systems - a range to suit every need.

High flexibility in installation, while reducing aesthetic impact and maximising comfort.

MULTIPLE INDOOR UNITS WITH ONLY ONE OUTDOOR

Individual control of each indoor.

WIDE RANGE OF CONNECTABLE UNITS

Wall-mounted, floor console and cassette with nanoe™ X.

SEAMLESS INTEGRATION OF OUTDOOR UNIT

Reduced outdoor unit space, harmonizing with building architecture.

REDUCED INSTALLATION TIME

Faster piping connection and pump-down time.

Why choose a multi split system?

With one indoor unit per room or area with individual control, it is easy to achieve the desired level of comfort throughout the home.

Outside, there is only one unit, which reduces the space required for the outdoor unit, improves the aesthetics of the building and makes installation easier.

Solution with multi split.

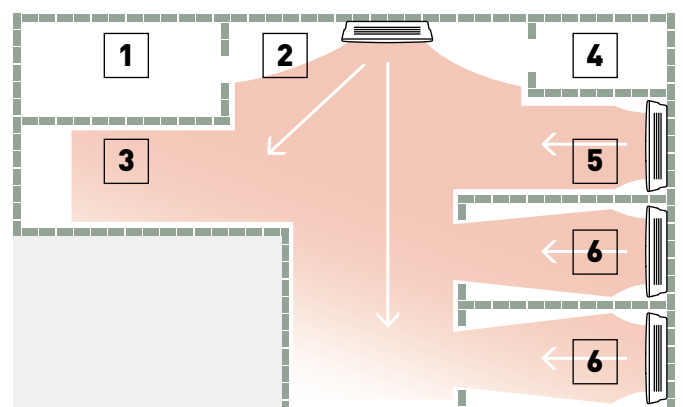

1. Laundry room. 2. Entrance. 3. Kitchen / dining area. 4. Bathroom. 5. Living room. 6. Bedroom.

Free Multi system. High flexibility for maximising comfort.

Full flexibility up to 9,0 kW and up to 5 ports with wide range of indoor units including high performance Etherea indoor units, reaching up to A+++ / A++.

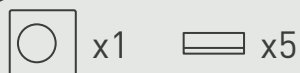

**UP TO 5 INDOOR UNITS
WITH ONLY ONE OUTDOOR**



**WIDE RANGE OF COMPATIBLE
INDOORS WITH nanoe™ X**

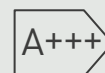

**SEER.
HIGH ENERGY EFFICIENCY
CLASS**

Power Heat Multi system. Reliable heating for cold winters.

Powerful heating of two or three rooms with one outdoor unit, even at -25 °C low outdoor temperatures.

POWER HEAT



**-25°C
RELIABLE HEATING
EVEN AT -25 °C**



**EQUIPPED WITH
BASE PAN HEATER**



**EXCELLENT
MAINTAINABILITY.
ADVANTAGEOUS UNDER
HARSH CONDITIONS.**



-25 °C outdoor temperature operation and base pan heater.

The heater prevents the outdoor unit base pan from freezing and ensures stable operation even in extremely cold regions.

Heating capacity at -25 °C outdoor temperature: 3,90 kW for the 2-room model and 4,30 kW for the 3-room model.

Efficiently heats 2 or 3 rooms using a single outdoor unit, even in low outdoor temperatures.

High-efficiency SCOP 4,60 A++.

High heating efficiency contributes to environmental protection while reducing electricity bills.

Dark color outdoor unit.

First outdoor unit in dark color, blending seamlessly with home exteriors without compromising aesthetics.

Connectable to Etherea indoor units.

Comfort and convenience with nanoe™ X and built-in Wi-Fi, combined with excellent heating and cooling performance.

Multi wall TZ system. The super compact multi split solution.

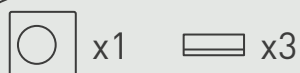

**UP TO 3 INDOOR UNITS WITH
ONLY ONE OUTDOOR**



**COMPACT OUTDOOR UNIT, TO
MINIMISE OUTDOOR UNIT
SPACE**



**COMPATIBLE WITH TZ SUPER-
COMPACT INDOOR UNITS,
WITH nanoe™ X**



Optional wired remote controller. CZ-RD517C



NEW! Wall-mounted Etherea	Indoor unit graphite grey	Indoor unit silver	Indoor unit matt white	Cooling capacity	Heating capacity	Connection in. / out.	Sound pressure ¹⁾		Dimension / Net weight	Piping diameter
							Cool — Heat (Hi/Lo/Q-Lo)	dB(A)		
1,6 kW	—	—	CS-MZ16CKE	1,60	2,60	4x1,5	37/26/21 — 38/27/21	295x870x229/10	1/4(6,35)/3/8(9,52)	
2,0 kW	CS-XZ20CKEW-H	CS-XZ20CKEW	CS-Z20CKEW	2,00	3,20	4x1,5	37/26/21 — 38/27/21	295x870x229/10	1/4(6,35)/3/8(9,52)	
2,5 kW	CS-XZ25CKEW-H	CS-XZ25CKEW	CS-Z25CKEW	2,50	3,60	4x1,5	41/27/21 — 41/29/21	295x870x229/10	1/4(6,35)/3/8(9,52)	
3,5 kW ²⁾	CS-XZ35CKEW-H	CS-XZ35CKEW	CS-Z35CKEW	3,50	4,50	4x1,5	44/30/21 — 45/35/21	295x870x229/11	1/4(6,35)/3/8(9,52)	
4,2 kW ³⁾	CS-XZ42CKEW-H	—	CS-Z42CKEW	4,20	5,60	4x1,5	44/33/27 — 45/37/31	295x870x229/10	1/4(6,35)/3/8(9,52)	
5,0 kW ⁴⁾	—	CS-XZ50CKEW	CS-Z50CKEW	5,00	6,80	4x2,5	44/39/32 — 46/39/32	295x1040x244/12	1/4(6,35)/3/8(9,52)	
7,1 kW	—	—	CS-Z71CKEW	7,10	8,70	4x2,5	49/40/32 — 49/40/32	295x1040x244/13	1/4(6,35)/1/2(12,70)	



Optional wired remote controller. CZ-RD517C



NEW! Wall-mounted TZ super-compact	Indoor unit	Cooling capacity	Heating capacity	Connection in. / out.	Sound pressure ¹⁾		Dimension / Net weight	Piping diameter
					Cool — Heat (Hi/Lo/Q-Lo)	dB(A)		
1,6 kW	CS-MTZ16CKE	1,60	2,60	4x1,5	38/27/22 — 39/28/24	290x765x214/9	1/4(6,35)/3/8(9,52)	
2,0 kW	CS-TZ20CKEW	2,00	3,20	4x1,5	39/27/22 — 40/28/23	290x765x214/9	1/4(6,35)/3/8(9,52)	
2,5 kW	CS-TZ25CKEW	2,50	3,60	4x1,5	42/28/22 — 44/35/23	290x765x214/9	1/4(6,35)/3/8(9,52)	
3,5 kW ²⁾	CS-TZ35CKEW	3,50	4,50	4x1,5	44/32/22 — 44/35/23	290x765x214/9	1/4(6,35)/3/8(9,52)	
4,2 kW	CS-TZ42CKEW	4,20	5,60	4x1,5	44/33/27 — 46/37/30	290x765x214/9	1/4(6,35)/3/8(9,52)	
5,0 kW	CS-TZ50CKEW	5,00	6,80	4x2,5	44/39/35 — 46/39/35	290x765x214/9	1/4(6,35)/3/8(9,52)	
6,0 kW	CS-TZ60CKEW	6,00	8,50	4x2,5	45/39/36 — 47/39/36	295x1060x249/14	1/4(6,35)/1/2(12,70)	
7,1 kW	CS-TZ71CKEW	7,10	8,70	4x2,5	49/40/37 — 49/40/37	295x1060x249/15	1/4(6,35)/1/2(12,70)	



Optional wired remote controller. CZ-RD517C



NEW! Floor console ⁵⁾	Indoor unit	Cooling capacity	Heating capacity	Connection in. / out.	Sound pressure ⁶⁾		Dimension / Net weight	Piping diameter
					Cool — Heat (Hi/Lo/Q-Lo)	dB(A)		
2,0 kW	CS-MZ20CFEA	2,00	3,20	4x1,5	39/27/22 — 39/27/21	600x750x207/13	1/4(6,35)/3/8(9,52)	
2,5 kW	CS-Z25CFEAW	2,50	3,60	4x1,5	40/27/22 — 40/27/21	600x750x207/13	1/4(6,35)/3/8(9,52)	
3,5 kW ²⁾	CS-Z35CFEAW	3,50	4,50	4x1,5	41/28/22 — 41/28/21	600x750x207/13	1/4(6,35)/3/8(9,52)	
5,0 kW	CS-Z50CFEAW	5,00	5,30	4x1,5	44/33/29 — 48/35/31	600x750x207/13	1/4(6,35)/3/8(9,52)	



Optional wired remote controller. CZ-RTC6W



Optional wired remote controller. CZ-RTC6

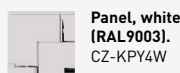

Panel, white (RAL9003). CZ-KPY4W



Panel, graphite black (RAL7024). CZ-KPY4B

Panels (sold separately)



4 way 60x60 cassette*	Indoor unit (Panel CZ-KPY4)	Cooling capacity	Heating capacity	Connection in. / out.	Sound pressure ⁷⁾		Dimension / Net weight		Piping diameter
					Cool — Heat (Hi/Lo/Q-Lo)	dB(A)	Indoor HxWxD	Panel HxWxD	
2,0 kW	S-M20PY3E	2,00	3,20	4x1,5	33/30/27 — 33/30/27	243x575x575/15	30x625x625/2,8	1/4(6,35)/3/8(9,52)	
2,5 kW	S-25PY3E	2,50	3,60	4x1,5	33/30/27 — 33/30/27	243x575x575/15	30x625x625/2,8	1/4(6,35)/3/8(9,52)	
3,5 kW ²⁾	S-36PY3E	3,50	4,50	4x1,5	36/32/27 — 36/32/27	243x575x575/15	30x625x625/2,8	1/4(6,35)/3/8(9,52)	
5,0 kW ⁴⁾	S-50PY3E	5,00	6,80	4x1,5	41/36/29 — 41/36/29	243x575x575/15	30x625x625/2,8	1/4(6,35)/3/8(9,52)	
6,0 kW	S-60PY3E	6,00	8,50	4x1,5	45/39/33 — 45/39/33	243x575x575/15	30x625x625/2,8	3/8(9,52)/1/2(12,70)	

* Compatible with Commercial control and connectivity accessories only. For detailed information go to the control systems section.



Optional wireless control kit. CZ-RL511D



NEW! Low static pressure hide-away	Indoor unit	Cooling capacity	Heating capacity	Connection in. / out.	Sound pressure ⁸⁾		Dimension / Net weight	Piping diameter
					Cool — Heat (Hi/Lo/Q-Lo)	dB(A)		
2,0 kW	CS-MZ20CD3EA	2,00	3,20	4x1,5	34/29/26 — 36/29/26	200x750x640/19	1/4(6,35)/3/8(9,52)	
2,5 kW	CS-Z25CD3EAW	2,50	3,60	4x1,5	35/29/26 — 37/29/26	200x750x640/19	1/4(6,35)/3/8(9,52)	
3,5 kW ²⁾	CS-Z35CD3EAW	3,50	4,50	4x1,5	35/29/26 — 37/29/26	200x750x640/19	1/4(6,35)/3/8(9,52)	
5,0 kW ⁴⁾	CS-Z50CD3EAW	5,00	6,80	4x1,5	41/31/28 — 41/32/29	200x750x640/19	1/4(6,35)/3/8(9,52)	
6,0 kW	CS-Z60CD3EAW	6,00	8,50	4x1,5	41/32/29 — 43/34/31	200x750x640/19	1/4(6,35)/1/2(12,70)	

1) The sound pressure of the indoor unit shows the value measured of a position of 1 m in front of the main body and 0,8 m below the unit. The sound pressure is measured in accordance with JIS C 9612. Q-Lo: Quiet mode. Lo: The lowest set fan speed. 2) Heating capacity in combination with Free Multi outdoor units except with CU-Z235CBE. In this case, the heating capacity is 4,20 kW. 3) Heating capacity in combination with Free Multi outdoor units except with CU-Z235CBE. In this case, the heating capacity is 5,00 kW. 4) Heating capacity in combination with Free Multi outdoor units except with CU-Z235CBE. In this case, the heating capacity is 5,30 kW. 5) Compatible only with 2 ports R32 outdoor CU-Z235CBE / CU-Z241CBE / CU-Z250CBE. Minimum quantity of connection: 2 indoor units. 6) The sound pressure of the units shows the value measured of a position 1 m in front of the main body and 1 m above floor. The sound pressure is measured in accordance with JIS C 9612. Q-Lo: Quiet mode. Lo: The lowest set fan speed. 7) The sound pressure of the indoor unit shows the value measured of a position of 1,5 m below the unit. The sound pressure is measured in accordance with JIS C 9612. Q-Lo: Quiet mode. Lo: The lowest set fan speed. 8) The sound pressure of the indoor unit shows the value measured of a position of 1,5 m below the unit with 1 m duct on the suction side and 2 m duct on the discharge side. The sound pressure is measured in accordance with JIS C 9612.

Power Heat Multi system

POWER HEAT

Outdoor units Power Heat Multi system - R32

- Operation range down to -25 °C
- Equipped with base pan heater
- High energy efficiency: SCOP of 4,60
- Etherea indoor units with nanoe™ X technology to improve protection 24/7
- Indoor units with built-in Wi-Fi for internet and Voice Control



OUTDOOR UNIT			CU-2Z50ABEC	CU-3Z75ABEC
Indoor nominal capacity			4,0 ~ 8,5 kW (2 room)	4,5 ~ 11,0 kW (3 room)
Cooling capacity	Nominal (Min - Max)	kW	5,30 (2,10 - 7,50)	7,50 (2,10 - 8,80)
EER ¹⁾			4,21	3,87
SEER ²⁾			8,00 A++	8,00 A++
Pdesign (cooling)		kW	5,30	7,50
Input power	Nominal (Min - Max)	kW	1,26 (0,36 - 2,06)	1,94 (0,38 - 2,45)
Heating capacity	Nominal (Min - Max)	kW	6,40 (1,70 - 8,70)	8,60 (1,70 - 10,60)
COP ¹⁾			4,18	4,26
Heating capacity at -15 °C	Max	kW	5,90	6,30
Heating capacity at -25 °C	Max	kW	3,90	4,30
SCOP ²⁾			4,40 A+	4,60 A++
Pdesign at -10 °C		kW	5,10	5,60
Input power	Nominal (Min - Max)	kW	1,53 (0,32 - 2,44)	2,02 (0,32 - 2,92)
Current	Heat / Cool	A	6,80 / 5,70	8,80 / 8,50
Power supply		V	230	230
Sound pressure ³⁾	Heat / Cool (Hi)	dB(A)	49 / 49	53 / 49
Dimension ⁴⁾	H x W x D	mm	795 x 875 x 320	795 x 875 x 320
Net weight		kg	58	62
Piping diameter	Liquid	Inch (mm)	1/4 (6,35)	1/4 (6,35)
	Gas	Inch (mm)	3/8 (9,52)	3/8 (9,52)
Pipe length range total		m	50	60
Pipe length range to one unit		m	3 ~ 25	3 ~ 25
Elevation difference (in / out)		m	15	15
Pre-charged pipe length		m	30	30
Additional gas amount		g/m	20	20
Refrigerant (R32) / CO ₂ Eq.		kg / T	1,92 / 1,296	2,42 / 1,634
Operating range	Heat Min ~ Max	°C	-25 ~ +24	-25 ~ +24
	Cool Min ~ Max	°C	-10 ~ +46	-10 ~ +46

1) EER and COP calculation is based in accordance to EN 14511. 2) Energy Label Scale from A+++ to D. 3) The sound pressure of the units shows the value measured of a position 1 m in front and 1 m in rear side of the main body. The sound pressure is measured in accordance with JIS C 9612. 4) Add 70 or 95 mm for piping port.



Possible outdoor / indoor units combinations

Rooms	Outdoor unit	Indoor capacity connected (Min - Max)	Wall-mounted Etherea			
			20	25	35	50
2	CU-2Z50ABEC	4,0 ~ 8,5 kW	•	•	•	•
3	CU-3Z75ABEC	4,5 ~ 11,0 kW	•	•	•	•



Optional wired remote controller. CZ-RD517C



NEW! Wall-mounted Etherea	Indoor unit graphite grey	Indoor unit silver	Indoor unit matt white	Cooling capacity	Heating capacity	Connection in. / out.	Sound pressure ¹⁾	Dimension / Net weight	Piping diameter	
				kW	kW		mm ²	Cool — Heat (Hi/Lo/Q-Lo)	H x W x D	Liquid / Gas
								dB(A)	mm / kg	Inch (mm)
2,0 kW	CS-XZ20CKEW-H	CS-XZ20CKEW	CS-Z20CKEW	2,00	3,20	4x1,5	39/26/21 — 40/27/21	295x870x229/10	1/4 (6,35) / 3/8 (9,52)	
2,5 kW	CS-XZ25CKEW-H	CS-XZ25CKEW	CS-Z25CKEW	2,50	3,60	4x1,5	41/27/21 — 43/29/21	295x870x229/10	1/4 (6,35) / 3/8 (9,52)	
3,5 kW	CS-XZ35CKEW-H	CS-XZ35CKEW	CS-Z35CKEW	3,50	4,50	4x1,5	44/30/21 — 45/35/21	295x870x229/11	1/4 (6,35) / 3/8 (9,52)	
5,0 kW	—	CS-XZ50CKEW	CS-Z50CKEW	5,00	6,80	4x2,5	44/39/32 — 46/39/32	295x1040x244/12	1/4 (6,35) / 1/2 (12,70)	

1) The sound pressure of the indoor unit shows the value measured of a position of 1 m in front of the main body and 0,8 m below the unit. The sound pressure is measured in accordance with JIS C 9612. Q-Lo: Quiet mode. Lo: The lowest set fan speed.

Multi wall TZ system

Outdoor units Multi wall TZ system - R32

- Up to 3 indoor units with a single outdoor unit
- Up to 3 rooms with individual control
- High energy efficiency class A++ SEER
- Flexible installation, compact units and large connection distance
- Indoor units compatible with internet and Voice Control



OUTDOOR UNIT			CU-2TZ41TBE	CU-2TZ50TBE	CU-3TZ52TBE
Indoor nominal capacity (Min - Max)			3,2 ~ 6,0 kW	3,2 ~ 7,7 kW	4,5 ~ 9,5 kW
Cooling capacity	Nominal (Min - Max)	kW	4,10 (1,50 - 4,70)	5,00 (1,50 - 5,40)	5,20 (1,80 - 6,60)
EER ¹⁾	Nominal (Min - Max)	W/W	4,14 (5,56 - 3,41)	3,85 (5,56 - 3,33)	4,52 (3,67 - 5,00)
SEER ²⁾			7,10 A++	7,00 A++	7,60 A++
Pdesign (cooling)		kW	4,10	5,00	5,20
Input power	Nominal (Min - Max)	kW	0,99 (0,27 - 1,38)	1,30 (0,27 - 1,62)	1,15 (0,36 - 1,80)
Annual energy consumption ³⁾		kWh/a	202	250	239
Heating capacity	Nominal (Min - Max)	kW	4,40 (1,10 - 6,30)	5,70 (1,10 - 6,40)	6,80 (1,60 - 7,50)
Heating capacity at -7 °C		kW	3,75	3,80	—
COP ¹⁾	Nominal (Min - Max)	W/W	4,44 (5,00 - 3,54)	4,35 (5,00 - 3,62)	4,28 (3,87 - 5,00)
SCOP ²⁾			4,30 A+	4,20 A+	4,20 A+
Pdesign at -10 °C		kW	3,50	4,50	5,00
Input power	Nominal (Min - Max)	kW	0,99 (0,22 - 1,78)	1,31 (0,22 - 1,77)	1,59 (0,32 - 1,94)
Annual energy consumption ³⁾		kWh/a	1139	1500	1667
Current	Cool / Heat	A	4,60 / 4,60	6,00 / 6,00	5,30 / 7,30
Power supply		V	230	230	230
Sound pressure ⁴⁾	Cool / Heat (Hi)	dB(A)	48 / 50	50 / 52	48 / 48
Dimension ⁵⁾	H x W x D	mm	542 x 780 x 289	542 x 780 x 289	795 x 875 x 320
Net weight		kg	35	35	71
Piping diameter	Liquid	Inch (mm)	1/4 (6,35)	1/4 (6,35)	1/4 (6,35)
	Gas	Inch (mm)	3/8 (9,52)	3/8 (9,52)	3/8 (9,52)
Pipe length range total		m	6 ~ 30	6 ~ 30	6 ~ 50
Pipe length range to one unit		m	3 ~ 20	3 ~ 20	3 ~ 25
Elevation difference (in / out)		m	10	10	15
Pre-charged pipe length		m	20	20	30
Additional gas amount		g/m	15	15	20
Refrigerant (R32) / CO ₂ Eq.		kg / T	0,9 / 0,6075	0,9 / 0,6075	2,1 / 1,4175
Operating range	Cool Min ~ Max	°C	-10 ~ +46	-10 ~ +46	-10 ~ +46
	Heat Min ~ Max	°C	-15 ~ +24	-15 ~ +24	-15 ~ +24

1) EER and COP calculation is based in accordance to EN 14511. 2) Energy Label Scale from A+++ to D. 3) The annual energy consumption is calculated in accordance to EU/626/2011. 4) The sound pressure of the units shows the value measured of a position 1 m in front and 1 m in rear side of the main body. The sound pressure is measured in accordance with JIS C 9612. 5) Add 70 or 95 mm for piping port.



Possible outdoor / indoor units combinations

Rooms	Outdoor unit	Indoor capacity connected (Min - Max)	Wall-mounted TZ super-compact					
			16	20	25	35	42	50
2	CU-2TZ41TBE	3,2 ~ 6,0 kW	•	•	•	•		
	CU-2TZ50TBE	3,2 ~ 7,7 kW	•	•	•	•	•	•
3	CU-3TZ52TBE	4,5 ~ 9,5 kW	•	•	•	•	•	•

Minimum quantity of connection: 2 indoor units.

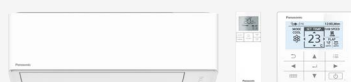

Optional wired remote controller. CZ-RD517C



NEW! Wall-mounted TZ super-compact	Indoor unit	Cooling capacity	Heating capacity	Connection in. / out.	Sound pressure ¹⁾		Dimension / Net weight	Piping diameter
					Cool — Heat (Hi/Lo/Q-Lo)	dB(A)		
1,6 kW	CS-MTZ16CKE	1,60	2,60	4x1,5	38/27/22 — 39/28/24		290 x 765 x 214/8	1/4 (6,35) / 3/8 (9,52)
2,0 kW	CS-TZ20CKEW	2,00	3,20	4x1,5	37/25/20 — 38/26/22		290 x 765 x 214/8	1/4 (6,35) / 3/8 (9,52)
2,5 kW	CS-TZ25CKEW	2,50	3,60	4x1,5	40/26/20 — 40/27/22		290 x 765 x 214/8	1/4 (6,35) / 3/8 (9,52)
3,5 kW	CS-TZ35CKEW	3,50	4,50	4x1,5	42/30/20 — 42/33/22		290 x 765 x 214/8	1/4 (6,35) / 3/8 (9,52)
4,2 kW	CS-TZ42CKEW	4,20	5,60	4x1,5	44/31/29 — 44/35/34		290 x 765 x 214/8	1/4 (6,35) / 1/2 (12,70)
5,0 kW	CS-TZ50CKEW	5,00	6,80	4x2,5	44/37/33 — 44/37/33		290 x 765 x 214/8	1/4 (6,35) / 1/2 (12,70)

1) The sound pressure of the indoor unit shows the value measured of a position of 1 m in front of the main body and 0,8 m below the unit. The sound pressure is measured in accordance with JIS C 9612. Q-Lo: Quiet mode. Lo: The lowest set fan speed. * Available for use with Multi TZ outdoor units from Summer 2026.

RAC Solo, the compact air conditioner without outdoor unit

A high-efficiency RAC Solo with a hyper-compact design that minimises aesthetic impact. Just 16,5 cm deep, easy to install and with DC Inverter technology to optimise performance.



Seamless integration, indoors and outdoors

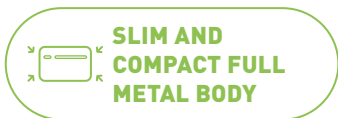

Only 16,5 cm deep (indoor).



Just two 162 mm holes*.
* 202 mm for the biggest capacity.



Stand-alone unit with no refrigerant connections.



Open only during operation.

Easy and flexible installation, without outdoor unit

The RAC Solo range offers great installation flexibility as it is a stand-alone unit with no refrigerant connections during installation. The outdoor unit is replaced by two holes in the wall.

All you need is a perimeter wall, to exchange air with the outside. The unit can be placed high on the wall or low on the floor.

Down installation.

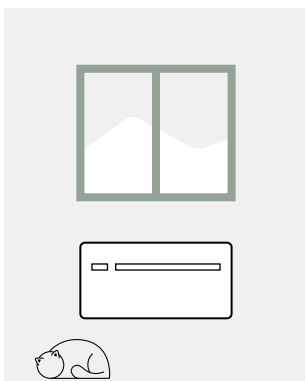

Overhead installation.

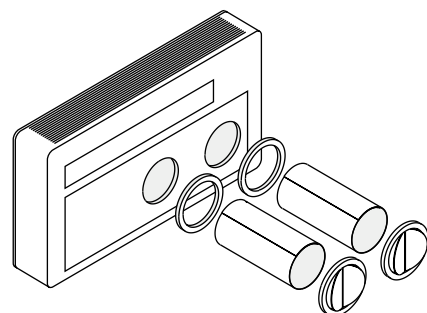
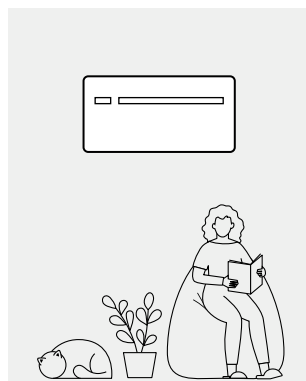

RAC Solo - R290 / R32

- Slim and compact, only 165 mm deep
- No outdoor unit
- Heating and cooling or cooling only modes available
- DC Inverter technology
- No frost system, with preheated condenser water tray
- Easy and flexible installation
- On-board display with built-in Wi-Fi: Smart control via the Aquarea Home App



KIT MATT WHITE			P-MOG161C5-E	P-MOZ201C5-E	P-MOZ251C5-E	P-MOZ301C5-E
Cooling capacity	Nominal (Min - Max)	kW	1,73 (0,70 - 2,35)	2,09 (0,83 - 2,64)	2,33 (0,92 - 3,10)	2,87 (1,40 - 3,50)
EER ¹⁾	W/W		3,01 A	3,29 A+	3,25 A+	2,74 A
SEER ²⁾			4,60	4,70	4,60	4,10
Input power		kW	0,57	0,64	0,73	1,04
Heating capacity	Nominal (Min - Max)	kW	1,71 (0,75 - 2,40)	2,08 (0,71 - 2,64)	2,31 (0,79 - 3,05)	2,75 (1,35 - 3,50)
Heating capacity at -7 °C		kW	1,13	1,37	1,52	1,81
COP ¹⁾	W/W		3,15 A	3,31 A+	3,28 A+	3,12 A
SCOP ²⁾			3,70	3,80	3,70	3,40
Input power		kW	0,54	0,63	0,71	0,88
Power supply		V	230	230	230	230
Maximum current		A	3,90	4,10	4,60	6,30
Air flow	Max / Average / Min	m ³ /min	6,0/5,0/4,0	6,3/5,2/4,3	6,7/5,3/4,5	7,5/5,8/5,0
External air flow	Max / Average / Min	m ³ /min	7,2/6,0/5,3	7,7/6,3/5,5	8,0/6,5/5,7	9,2/7,7/6,7
Moisture removal volume		L/h	0,7	0,8	0,9	1,2
Sound pressure ³⁾	Hi / Lo / Q-Lo	dB(A)	39/29/27	39/30/26	41/31/27	43/33/29
Outside sound pressure ³⁾	Hi / Lo	dB(A)	49/36	49/36	51/38	53/40
Refrigerant / charge		kg	R290 / 0,14	R32 / 0,5	R32 / 0,5	R32 / 0,5
Dimension	H x W x D	mm	549 x 810 x 165	549 x 1010 x 165	549 x 1010 x 165	549 x 1010 x 165
Net weight		kg	38	41	41	41
Wall hole diameter		mm	162	162	162	202
Distance between wall holes		mm	293	293	293	293
Operating range	Cool Min ~ Max	°C	-5 ~ +43	-5 ~ +43	-5 ~ +43	-5 ~ +43
	Heat Min ~ Max	°C	-15 ~ +18	-15 ~ +18	-15 ~ +18	-15 ~ +18

1) EER and COP in accordance to 626/2011. Scale A+++ to D. 2) SEER and SCOP in accordance to EN 14511. 3) The sound pressure shows the value measured at 2 m, according to ISO 7779.

Accessories	
PCZ-GB0738	Kit of external aluminium grids with fixed fins (162 mm holes)
PCZ-GB1091	Kit of external aluminium grids with fixed fins (202 mm holes)
PCZ-GB0755	Insect protection kit (1 metal mesh, 1 grid in metal wire and fixing accessories). Only for connection with PCZ-GB0738.
PCZ-L00773	Side exit formwork for corner installation for P-MOZ20/251C5-E (right-hand outlet)

Accessories	
PCZ-L00774	Side exit formwork for corner installation for P-MOZ20/251C5-E (left-hand outlet)
PCZ-GB0737	Bottom cover kit for overhead installation for P-MOZ20/25/301C5-E
PCZ-GB1105	Bottom cover kit for overhead installation for P-MOG161C5-E
PCZ-GB1119	Condensate drain pipe heater kit*

* Check availability.



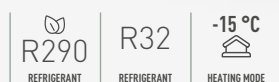









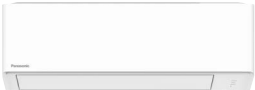

The side installation kit, which must be embedded in the wall, allows the air flow to be redirected sideways for greater installation flexibility. For P-MOZ201C5-E and P-MOZ251C5-E.



R290: For P-MOG161C5-E. R32: For P-MOZ201C5-E, P-MOZ251C5-E and P-MOZ301C5-E.



































Rating conditions: Cooling indoor 27 °C DB / 19 °C WB. Cooling outdoor 35 °C DB / 24 °C WB. Heating indoor 20 °C DB. Heating outdoor 7 °C DB / 6 °C WB. (DB: Dry Bulb; WB: Wet Bulb). Specifications subject to change without notice. For detailed information about ErP / Energy Labelling, please visit our websites www.aircon.panasonic.eu or www.ptc.panasonic.eu.

Compare split solutions

	Indoor unit dimension	Efficiency ¹⁾	Indoor air quality	Outdoor temperature	Comfort	Super Quiet	Connectivity
NEW! Wall-mounted Etherea - 2,0 to 7,1 kW 	295 x 870 x 229 (295 x 1040 x 244 wide model)	A+++ A+++	 nanoe X Generator Mark 3	-10 °C in cooling mode -20 °C in heating mode	Aerowings 2.0	 19 dB(A)	Built-in Wi-Fi
NEW! Wall-mounted TZ super-compact - 2,0 to 7,1 kW 	290 x 765 x 214 (295 x 1060 x 249 wide model)	A++ A++	 nanoe X Generator Mark 2	-10 °C in cooling mode -15 °C in heating mode	Aerowings	 20 dB(A)	Built-in Wi-Fi
NEW! Wall-mounted BZ super-compact - 2,5 to 6,0 kW 	290 x 765 x 214	A++ A+	PM2,5 Filter	-10 °C in cooling mode -15 °C in heating mode	Aerowings	 20 dB(A)	Built-in Wi-Fi
NEW! Wall-mounted UZ super-compact - 2,5 to 5,0 kW 	290 x 765 x 214	A++ A+	Dust collection filter	-10 °C in cooling mode -15 °C in heating mode	Aerowings	 20 dB(A)	Built-in Wi-Fi
NEW! Floor console - 2,5 to 5,0 kW 	600 x 750 x 207	A++ A++	 nanoe X Generator Mark 3	-10 °C in cooling mode -15 °C in heating mode	Double air flow	 20 dB(A)	Built-in Wi-Fi
NEW! Low static pressure hide-away - 2,5 to 6,0 kW 	200 x 750 x 640	A++ A+	Air filter	-10 °C in cooling mode -15 °C in heating mode	Weekly timer	 24 dB(A)	—

1) Energy efficiency class in 2,5 kW references. * All data in this chart is applicable in most of the models in each line up, check product specifications to confirm.

Single split feature overview

Models	Wall-mounted Etherea	Wall-mounted TZ super-compact	Wall-mounted BZ super-compact	Wall-mounted UZ super-compact	Floor console	Low static pressure hide-away
 Refrigerant R32	✓	✓	✓	✓	✓	✓
 AI ECO - boost energy savings	✓					
 Inverter+ system	✓				✓	
 Inverter system		✓	✓	✓		✓
 R2 rotary compressor	✓	✓	✓	✓	✓	✓
 nanoe X Generator	✓ Mark 3	✓ Mark 2			✓ Mark 3	
 PM2,5 Filter			✓			
 Dust collection filter				✓		
 Antiallergy properties	✓	✓			✓	
 Super Quiet ¹⁾	✓ 19 dB(A) for 2,0, 2,5 and 3,5 kW	✓ 20 dB(A) for 2,0, 2,5 and 3,5 kW	✓ 20 dB(A) for 2,5 and 3,5 kW	✓ 20 dB(A) for 2,5 and 3,5 kW	✓ 20 dB(A) for 2,5 and 3,5 kW	
 Internal cleaning	✓					
 Aerowings	✓	✓	✓	✓		
 Down to -10 °C in cooling only	✓	✓	✓	✓	✓	✓
 Down to -15 °C in heating mode	✓ -20 °C	✓	✓	✓	✓	✓
 R410A/R22 Renewal	✓	✓	✓	✓	✓	✓
 Odour-removing function	✓	✓	✓	✓	✓	✓
 Removable, washable panel	✓	✓	✓	✓	✓	
 Powerful mode	✓	✓	✓	✓	✓	✓
 Soft dry operation mode	✓	✓	✓	✓	✓	✓
 Personal air flow creation	✓	✓ For 6,0 and 7,1 kW				
 Automatic vertical air flow control		✓ For 2,0, 2,5, 3,5, 4,2 and 5,0 kW	✓	✓	✓	
 Manual horizontal air flow control		✓ For 2,0, 2,5, 3,5, 4,2 and 5,0 kW	✓	✓	✓	
 Auto mode	✓	✓	✓	✓	✓	✓
 Hot start mode	✓	✓	✓	✓	✓	✓
 Real time clock with dual ON / OFF timer	✓	✓	✓	✓	✓	
 Weekly timer						✓
 LCD infrared remote controller	✓	✓	✓	✓	✓	
 Automatic restart	✓	✓	✓	✓	✓	✓
 Long piping	✓ 15 m, 30 m [5,0 and 7,1 kW]	✓ 15 m, 20 m [5,0 kW], 30 m [7,1 and 6,0 kW]	✓ 15 m, 30 m [6,0 kW]	✓ 15 m	✓ 20 m, 30 m [5,0 kW]	✓ 20 m, 30 m [5,0 and 6,0 kW]
 Top-Panel maintenance access	✓	✓	✓	✓	✓	✓
 Self-diagnosis function	✓	✓	✓	✓	✓	✓
 RAC interface adapter for integration into S-Link	✓	✓	✓	✓	✓	✓
 Wi-Fi control	✓ Built-in	✓ Built-in	✓ Built-in	✓ Built-in	✓ Built-in	
 Easy control by BMS	✓	✓	✓	✓	✓	✓
 Warranty on the compressor	✓	✓	✓	✓	✓	✓

1) At the lowest fan speed. 2) Tested by 3rd party laboratory, SP, according to EN 14511:2013 and SP Method 1721, this temperature is not guaranteed by Factory.

Features explained

Energy saving.



NATURAL REFRIGERANT R290 WITH GWP 3. Natural refrigerant R290 has low Global Warming Potential (GWP) of just 3, helping reduce CO₂ emissions and environmental impact.



REFRIGERANT R32. Our heat pumps containing R32 refrigerant show a drastic reduction in the value of Global Warming Potential (GWP).



EXCEPTIONAL SEASONAL COOLING EFFICIENCY BASED ON THE ERP REGULATION. Higher SEER ratings mean greater efficiency and year-round cooling savings!



EXCEPTIONAL SEASONAL HEATING EFFICIENCY BASED ON THE ERP REGULATION. Higher SCOP ratings mean greater efficiency and year-round heating savings!



AI ECO MODE - Boost energy savings by up to 20% in cooling mode. Learns room conditions and balances energy saving with faster cooling



INVERTER PLUS SYSTEM. Inverter Plus system classification highlights Panasonic's highest performing systems.



INVERTER. The Inverter range provides greater efficiency and comfort. Provides more precise temperature control, without highs and lows, and keeps the ambient temperature constant with lower energy consumption and a significant reduction in noise and vibration levels.



Panasonic R2 rotary compressor. Designed to withstand extreme conditions, it delivers high performance and efficiency.

High performance and indoor air quality.



nanoe™ X. Technology with the benefits of hydroxyl radicals has the capacity to inhibit pollutants, viruses, and bacteria to clean and deodorise.



PM2,5 FILTER. This filter can capture airborne particulate matter (PM2,5), including hazardous pollutants, as well as house dust and pollen.



DUST COLLECTION FILTER. This filter collects and retains particles suspended in the air, resulting in cleaner air in the room.



SUPER QUIET. With Super Quiet technology our devices are quieter than a library.



INTERNAL CLEANING. This function works to dry-off to inside of indoor unit with nanoe™ X. It can inhibit certain adhered bacteria, viruses and mould up to 99% efficiency.



MORE COMFORT WITH AEROWINGS. Panasonic's Aerowings feature incorporates two blades that concentrate the air flow to cool or heat in the shortest possible time by distributing the air evenly throughout the room.



STATIC PRESSURE UP TO 7 MMAQ. Low static pressure hide-away with selectable static pressure up to 7 mmAq.



FILTER INCLUDED. Hide-away with filter included.



DOWN TO -10 °C IN COOLING MODE. The air conditioner works in cooling mode when the outdoor temperature of -10 °C.



DOWN TO -15 °C IN HEATING MODE. The air conditioner works in heat pump mode when the outdoor temperature is as low as -15 °C.



R410A/R22 RENEWAL. The Panasonic renewal system allows good quality existing R410A or R22 pipe work to be re-used whilst installing high-efficiency R32 systems.



ANTIALLERGY PROPERTIES. System is equipped with anti-allergy properties filter.



ODOUR-REMOVING FUNCTION. Allows the exchanger to be cleaned, preventing possible odours. While this function is connected, the fan also remains OFF momentarily to avoid unpleasant odours while the exchanger is being cleaned.

High performance and indoor air quality (cont.).



REMOVABLE, WASHABLE PANEL. The front panel is easy to keep clean. It can be removed quickly in one single step and can be washed in water. A clean front panel ensures smoother, more efficient operation, which can save energy.



POWERFUL MODE. The rapid and effective powerful mode is ideal for when you come home on the hottest or coldest days. It works at maximum power to reach the desired temperature in just 15 minutes.



SOFT DRY OPERATION MODE. The soft dry mode eliminates excess moisture with a soft breeze and provides a sense of wellbeing without much change in temperature.



PERSONAL AIR FLOW CREATION. Permits the air direction to be adjusted vertically and horizontally. This feature can be conveniently selected by remote controller.



AUTOMATIC VERTICAL AIR FLOW CONTROL. The flap swings up and down automatically. The flow can also be set at a fixed angle with the remote controller.



MANUAL HORIZONTAL AIR FLOW CONTROL.



AUTO MODE. Automatically switches the current operation mode to heating or cooling mode necessary to keep the temperature at a constantly comfortable level based on the temperature of the room. In case of multi split installation the function is limited to first unit working and logic of switching is different considering also the outdoor temperature.



HOT START MODE. At the start of heating cycle and after defrost cycle, the indoor fan will start up once the indoor heat exchanger is warm.



REAL TIME CLOCK WITH DUAL ON / OFF TIMER. This feature enables you to preset two different sets of start/stop operation timer (hour and minute) within a 24-hour time frame.



WEEKLY TIMER. Allow to fix per each day of the week up to 6 operations per day.



LCD INFRARED REMOTE CONTROLLER.



AUTOMATIC RESTART. This function permits automatic restarting if safe mode operation has stopped for some unusual reason, such as after a power cut. As soon as the power is back, the unit restarts with the parameters selected before it stopped.



LONG PIPING. Indicates the maximum length of pipe between the outdoor unit and the indoor unit(s). The distances permitted, demonstrate the installations possible.



TOP-PANEL MAINTENANCE ACCESS. Maintenance of an outdoor unit used to be quite a tedious task. Now, with the possibility of removing the top cover, maintenance is quick and easy.



SELF-DIAGNOSIS FUNCTION. With this function the unit carries out a process self-diagnosis when a particular function does not work correctly. This allows faster servicing.



5 YEARS COMPRESSOR WARRANTY. We guarantee the outdoor unit compressors in the entire range for five years.

High connectivity.



DOMESTIC INTEGRATION TO S-LINK - CZ-CAPRA1. Can connect RAC range to S-Link. Full control is now possible.



WI-FI CONTROL. The Panasonic Comfort Cloud App allows users to conveniently manage and monitor Panasonic residential heat pumps from a mobile device, anytime, anywhere.



BMS CONNECTIVITY. Panasonic air conditioners offer seamless integration into a Building Management System (BMS) using an optional gateway.

Accessories and control

Connectivity



Interface adapter for integration into S-Link, plus external input and alarm/status output.

CZ-CAPRA1



KNX gateway powered via CN-CNT. For RAC models with CN-CNT connector.

PAW-AC-KNX-1i



KNX gateway with 12 V DC power supply. For RAC models with CN-CNT connector.

PAW-AZAC-KNX-1



DIN rail-mounted Modbus gateway, powered via CN-CNT. For RAC models with CN-CNT connector.

PAW-AC-MBS-1



Modbus gateway with 12 V DC power supply. For RAC models with CN-CNT connector.

PAW-AZAC-MBS-1



DIN rail-mounted BACnet gateway, powered via CN-CNT. For RAC models with CN-CNT connector.

PAW-AC-BAC-1



BACnet gateway with 12 V DC power supply. For RAC models with CN-CNT connector.

PAW-AZAC-BAC-1



Dry contact interface for RAC models with CN-RMT connector.

PAW-AC-DIO

Individual controls



Wired remote controller for wall-mounted and floor console.

CZ-RD517C



Infrared remote controller Sky Remote. 2 m cable length of infrared receiver for hide-away.

CZ-RL511D

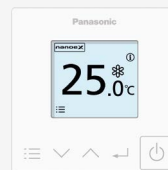

CONEX wired remote controller (non-wireless) for 4 way 60x60 cassette - PY3, white.

CZ-RTC6W



CONEX wired remote controller (non-wireless) for 4 way 60x60 cassette - PY3, black.

CZ-RTC6

Panels



Panel for 4 way 60x60 cassette, white (RAL9003).

CZ-KPY4W



Panel for 4 way 60x60 cassette, graphite black (RAL7024).

CZ-KPY4B

Pipe reducer



Reduces the connection size on the indoor unit from 1/2" to 3/8".

CZ-MA1PA



Increases the connection size on the outdoor unit from 3/8" to 1/2".

CZ-MA2PA



Reduces the connection size on the indoor unit from 5/8" to 1/2".

CZ-MA3PA

RAC Solo accessories

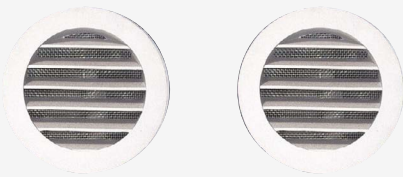

Kit of external aluminium grids with fixed fins (162 mm holes).

PCZ-GB0738

Kit of external aluminium grids with fixed fins (202 mm holes).

PCZ-GB1091

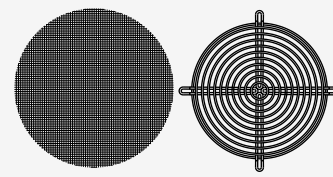

Insect protection kit (1 metal mesh, 1 grid in metal wire and fixing accessories). Only for connection with PCZ-GB0738.

PCZ-GB0755



Side exit formwork for corner installation for P-MOZ20/25IC5-E (right-hand outlet).

PCZ-L00773

Side exit formwork for corner installation for P-MOZ20/25IC5-E (left-hand outlet).

PCZ-L00774

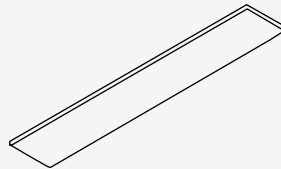

Bottom cover kit for overhead installation for P-MOZ20/25/30IC5-E.

PCZ-GB0737

Bottom cover kit for overhead installation for P-MOG16IC5-E.

PCZ-GB1105

Condensate drain pipe heater kit*.

PCZ-GB1119

* Check availability.

To find out how Panasonic cares for you, log on to:

www.panasonic.co.uk/aircon

General requests:

Email: uk-aircon@eu.panasonic.com

Sales administration team:

Email: sales.PHVACUK@eu.panasonic.com

Technical service team:

Email: technical.PHVACUK@eu.panasonic.com

UK Office : +44 (0) 1707 378670

Panasonic Heating & Ventilation Air-Conditioning UK Ltd.

Registered Office: Ground Floor, Building 3, Albany Place, Hyde Way,
Welwyn Garden City, Hertfordshire AL7 3BT
Company Registration: 02371708



Do not add or replace refrigerant other than the specified type. Manufacturer is not responsible for the damage and deterioration in safety due to usage of the other refrigerant.

The outdoor units in this catalogue contains fluorinated greenhouse gases with a GWP higher than 150.

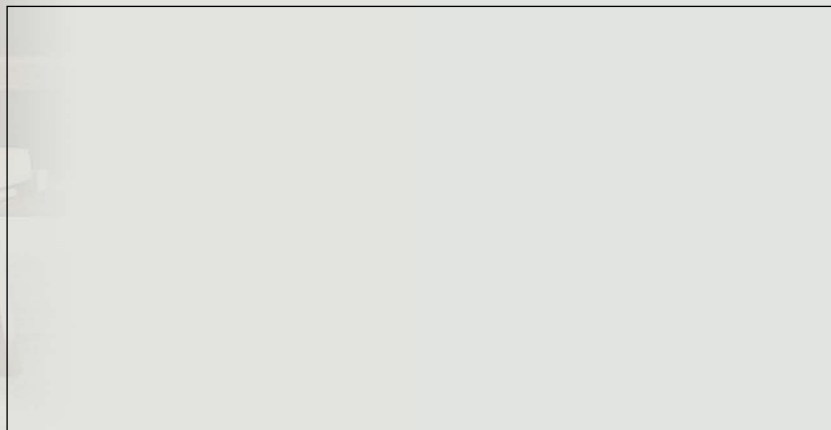

Due to the ongoing innovation of our products, the specifications of this catalogue are valid barring typographic errors, and may be subject to minor modifications by the manufacturer without prior warning in order to improve the product. The total or partial reproduction of this catalogue is prohibited without the express authorisation of Panasonic Marketing Europe GmbH.