

PRODUCT OVERVIEW

INTERSPIRO



DIVATOR

THE COMPLETE DIVING SYSTEM

DIVATOR PRODUCT OVERVIEW



A tragic bus accident in Sweden after the Second World War raised the concern that divers could not be quickly deployed to the crash site. The Swedish government asked Interspiro (“AGA” at that time) if they could provide a rapid deployment diving device for search and rescue operations.

Interspiro began an extensive research program and in 1948 the Worlds first underwater breathing apparatus for search and rescue was presented to the Swedish authorities.

The device, commonly referred to as the “iron bed” (because of the shape of the carrying frame), featured a breathing valve with inhalation and exhalation in the same diaphragm. The first of many Interspiro innovations in the field of diving.

Today, over 60 years later, the latest generation of Interspiro SCUBA – DIVATOR – is still the preferred choice for professional divers around the World.

The Interspiro diving philosophy is a system approach. The reason is simple and obvious, to obtain the highest possible safety level for professional divers.

CONTENT



| | |
|---|----------|
| FULL FACE MASKS & BREATHING VALVES | 4 |
| Full Face Masks | 6 |
| Breathing Valves | 7 |
| Mask Accessories | 7 |
| HUD (Heads-Up Display) | 8 |
| Accessory Rail System | 8 |

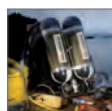

| | |
|-------------------|----------|
| REGULATORS | 9 |
| RS4 Regulator | 10 |
| MKIII Regulator | 12 |
| MKII Regulator | 14 |



| | |
|----------------------------------|-----------|
| CYLINDERS | 16 |
| DIVATOR LITE Composite Cylinders | 17 |
| Steel Cylinders | 19 |



| | |
|------------------------|-----------|
| CARRYING SYSTEM | 20 |
| Rescue BC | 21 |
| BCW | 23 |
| Weight System | 25 |
| BCW & BC Accessories | 25 |
| Harness | 26 |



| | |
|---------------------------|-----------|
| DP1 SURFACE SUPPLY | 27 |
| DP1 Surface Supply | 28 |



| | |
|------------------|-----------|
| IBSOPHONE | 30 |
| Ibsophone | 30 |



| | |
|--------------------|-----------|
| ACCESSORIES | 31 |
| Accessories | 31 |
| Canister Light | 33 |

FULL FACE MASKS & BREATHING VALVES

The DIVATOR Full Face Mask is the World's most sold full-face mask. Even if you are not acquainted with Interspiro products, it is quite likely that you have seen the DIVATOR Full Face Mask watching professional divers on television.

But the real magic is not the face mask, rather is it the balanced breathing valve with its high capacity, low breathing resistance and extreme resilience to dangerous fluids.

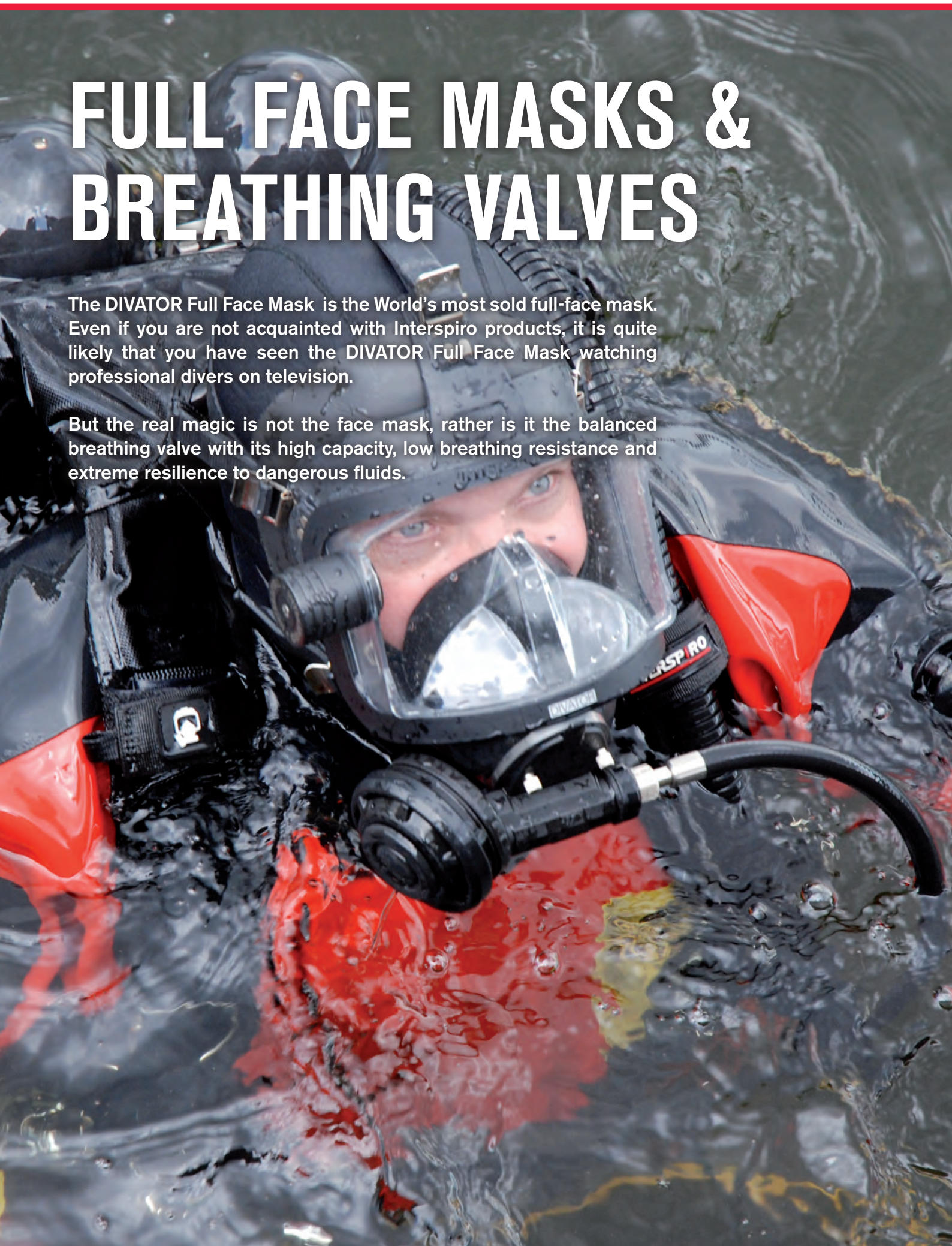

FULL FACE MASKS & BREATHING VALVES

The DIVATOR Full Face Mask consists of a balanced breathing valve with high air flow capacity and low breathing resistance. The DIVATOR Breathing Valve is available without safety pressure, and with safety pressure for diving in contaminated water.

Specially-designed visor gives divers excellent field of vision while reducing positive buoyancy. The full face mask can be equipped with the DIVATOR Heads-Up Display (HUD) low air warning and the DIVATOR Hatch, an ambient breathing valve enabling divers to keep the face mask donned while on stand-by.



- 1** The balanced DIVATOR breathing valve is one of the best-tested breathing valves available. It will perform even in the most extreme of conditions: mud, oil, and fast flowing cold currents does not have a serious impact on the performance.
- 2** The low volume visor reduce the positive buoyancy generated from air inside the mask. Low volume "dead space" reduces re-inhalation of CO₂.
- 3** The DIVATOR Full Face Mask is very easy to drain from water inside the mask, simply press the purge button and hold the mask against the face.
- 4** The mask is equipped with retainers spectacle inserts and it is prepared for underwater communication. The communication capabilities are enhanced by the airflow design that considerably reduces turbulence noise.

FULL FACE MASKS

Full Face Mask with Breathing Valve



| Part No. | Description |
|----------|---|
| 96319-01 | Yellow silicone mask without safety pressure |
| 96319-02 | Yellow silicone mask with safety pressure |
| 96319-03 | Gray natural rubber mask without safety pressure |
| 96319-04 | Gray natural rubber mask with safety pressure |
| 96319-05 | Black silicone mask without safety pressure |
| 96319-06 | Black silicone mask with safety pressure |
| 96319-10 | Black natural rubber mask without safety pressure |
| 96319-11 | Black natural rubber mask with safety pressure |

Full Face Mask without Breathing Valve



| Part No. | Description |
|-----------|---------------------------|
| 336190901 | Yellow silicone mask |
| 336190852 | Gray natural rubber mask |
| 336101161 | Black silicone mask |
| 97771-01 | Black natural rubber mask |

Full Face Mask with Hatch and Breathing Valve



| Part No. | Description |
|----------|---|
| 96319-14 | Yellow silicone mask without safety pressure |
| 96319-15 | Yellow silicone mask with safety pressure |
| 96319-12 | Gray natural rubber mask without safety pressure |
| 96319-13 | Gray natural rubber mask with safety pressure |
| 96319-16 | Black silicone mask without safety pressure |
| 96319-17 | Black silicone mask with safety pressure |
| 96319-20 | Black natural rubber mask without safety pressure |
| 96319-21 | Black natural rubber mask with safety pressure |

Full Face Mask with Hatch, without Breathing Valve



| Part No. | Description |
|----------|---------------------------|
| 97265-02 | Yellow silicone mask |
| 97265-01 | Gray natural rubber mask |
| 97265-03 | Black silicone mask |
| 97265-05 | Black natural rubber mask |

Mask Visor with Hatch



| Part No. | Description |
|----------|--|
| 96962-01 | Visor with mounted Hatch. For upgrade of mask. |

HATCH

The DIVATOR Hatch consists of an ambient breathing valve mounted on the side of the full face mask visor – not interfering with the field of vision – and gives the diver ambient air while on stand-by or at surface level.

The Hatch is easy to operate: pull to open and push to close.

Ambient breathing will not only increase cylinder duration time but will enable the diver to keep the full face mask donned while on stand-by.



BREATHING VALVES

Breathing Valve for Full Face Mask

| | Part No. | Description |
|---|-----------|-------------------------------|
|  | 336101149 | Black with safety pressure |
| | 336101150 | Black without safety pressure |

Octopus Breathing Valve

| | Part No. | Description |
|---|----------|--|
|  | 97199-02 | Complete with yellow shield ring and locking lever, without safety pressure. |

Breathing Valve with Mouthpiece (for autonomous diving)

| | Part No. | Description |
|---|----------|--|
|  | 97199-01 | Black breathing valve with moutpiece, without safety pressure. |

Mouthpiece

| | Part No. | Description |
|---|-----------|--|
|  | 336190353 | Complete mouthpiece kit, for conversion of breathing valve, without safety pressure. |

MASK ACCESSORIES

Mask Visor Weights

| | Part No. | Description |
|--|-----------|---|
|  | 336190854 | Mask visor weights, complete, pair (2 x 350 gram) |

Mask Cover

| | Part No. | Description |
|---|-----------|---|
|  | 460190555 | Black front cover lid for the Full Face Mask. |

Spectacle Kit

| | Part No. | Description |
|--|----------|---|
|  | 96496-51 | For mounting of prescription lenses inside the full face mask (lenses not included) |

Pressure Equalizing Pad

| | Part No. | Description |
|---|----------|--|
|  | 88542-51 | Pressure equalizing pad, four slots, EPDM rubber |

Head Harness

The head harness is made in one piece of natural rubber.

| | Part No. | Description |
|--|-----------|------------------------------------|
|  | 460190457 | Head harness, black natural rubber |

Mask Bag

| | Part No. | Description |
|--|-----------|---------------------------------|
|  | 96484-51 | Mask storage bag |
| | 96484-52 | Mask storage bag with ID holder |
| | 331950280 | Mask bag with handle |

MASK VISOR WEIGHTS

The DIVATOR Mask Visor Weights can be attached to the Full Face Mask in order to compensate the mask's buoyancy.

When diving for prolonged periods of time, using visor weights is recommended practice.

Can not be used together with a hatch.



HUD (HEADS-UP DISPLAY)

There are two HUD versions; one with a warning level of 55 bar/800 psi and one with a warning level of 80 bar/1160 psi. The HUD is equipped with a universal 7/16 inch HP connection which will fit most standard diving regulators.

HUD with 55 bar/800 psi Warning Level

| Part No. | Description |
|----------|---|
| 89100-01 | With 1.75 meter (68") cable (For MOD) |
| 89100-02 | With 2.95 meter (116") cable (For MK III) |
| 89100-03 | With 1.45 meter (57") cable (For 820-860 mm hose) |
| 89100-04 | With 1.2 meter (47") cable (For MK II) |
| 89100-05 | With 2.45 meter (96") cable (For MK III) |

HUD 80 bar/1160 psi Warning Level

| Part No. | Description |
|----------|---|
| 89100-11 | With 1.75 meter (68") cable (For MOD) |
| 89100-12 | With 2.95 meter (116") cable (For MK III) |
| 89100-13 | With 1.45 meter (57") cable (For 820-860 mm hose) |
| 89100-14 | With 1.2 meter (47") cable (For MK II) |
| 89100-15 | With 2.45 meter (96") cable (For MK III) |

HUD Connectors

| Part No. | Description |
|----------|---|
| 97193-51 | HUD connection kit for DIVATOR regulators |
| 89140-01 | HP Connection 7/16 adjustable + male/female G 1/8 |
| 89140-02 | HP Connection 7/16 adjustable + male/female M8x1 |

HUD Cable Covers for MKIII

| Part No. | Description |
|----------|---|
| 32103-51 | Cover for breathing hose 560 mm (22") |
| 32103-52 | Cover for breathing hose 730 mm (29") |
| 32103-53 | Cover for pressure gauge 780 mm (31") |
| 32103-54 | Cover for reg. breathing hose 1020 mm (40") |



ACCESSORY RAIL SYSTEM

With the Accessory Rail System you can easily attach accessories like the Interspiro Welding Visor, Divelight, video head or any type of lamp to your DIVATOR full face mask.

Accessory Rail System

| Part No. | Description |
|----------|---|
| 30582-51 | Rail Holder (for left or right mounting on FFM) |
| 30584-51 | Universal Mount (incl. two sizes of hoseclamps) |
| 32315-51 | Slide Mount (for Divelight) |
| 32316-51 | Divelight (needs 2 x AA/LR batteries, not included) |
| 30581-51 | Welding Visor * (Welding glass DIN 7 included) |
| 31118-51 | Auto-darkening Glass (3-10 DIN) |

* Two Rail Holders (P/N 30582-51) needed for mounting.

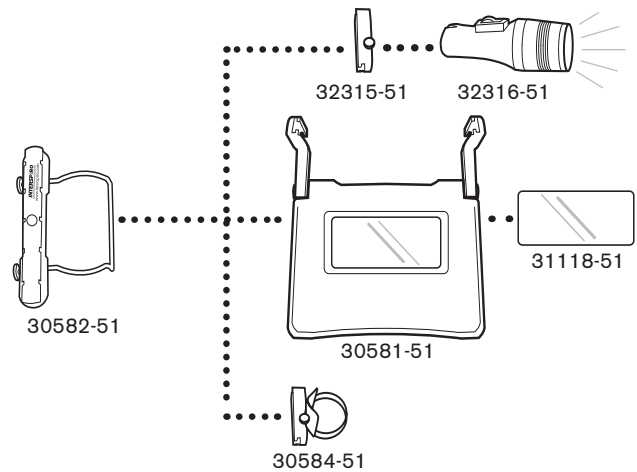

REGULATORS

Interspiro's diving regulators have extremely high flow capacity. Their design ensures that the intermediate pressure leading to the breathing valve is stable and is not affected by pressure variations in the air supply or the depth of the dive.



RS4 REGULATOR

The DIVATOR RS4 regulator is with its extremely rugged design and high performance designed to meet the highest of requirements from the toughest professional users.

The RS4 is a new alternative regulator choice to the well proven MKII and P+ regulators from Interspiro that have been on the market for many years.



- 1** Safety pressure to ensure no freezing.
- 2** Robust shockproof design with rubber cover.
- 3** Possibility to have up to four low pressure outputs to suit any specific needs.
- 4** Swiveling outputs for improved ergonomics.
- 5** Can be used with single cylinder or cylinder pack.
- 6** Available with DIN or Yoke cylinder connection.

RS4 REGULATOR

RS4 Regulator - 2-port SCUBA (dry suit/BC)

One outlet equipped with over pressure valve. The two HP outlets fitted with blank plugs. Delivered without pressure gauge.

| Part No. | Description |
|----------|--------------------------|
| 32940-01 | DIN cylinder connection |
| 32940-02 | Yoke cylinder connection |



RS4 Regulator - 2-port SCUBA + DP1

Delivered with DP1 Surface Supply connection and Basic pressure gauge (some models).

| Part No. | Description |
|----------|--|
| 32960-01 | Bar pressure gauge, DIN cylinder connection |
| 32960-02 | Bar pressure gauge, Yoke cylinder connection |
| 32960-11 | Psi pressure gauge, DIN cylinder connection |
| 32960-12 | Psi pressure gauge, Yoke cylinder connection |
| 32960-21 | DIN cylinder connection, No pressure gauge |
| 32960-22 | Yoke cylinder connection, No pressure gauge |



RS4 Regulator - 4-port SCUBA

Delivered with Basic pressure gauge (some models).

| Part No. | Description |
|----------|--|
| 32950-01 | Bar pressure gauge, DIN cylinder connection |
| 32950-02 | Bar pressure gauge, Yoke cylinder connection |
| 32950-11 | Psi pressure gauge, DIN cylinder connection |
| 32950-12 | Psi pressure gauge, Yoke cylinder connection |
| 32950-21 | DIN cylinder connection, No pressure gauge |
| 32950-22 | Yoke cylinder connection, No pressure gauge |



RS4 Regulator - 4-port SCUBA + DP1

Delivered with DP1 Surface Supply connection and Basic pressure gauge (some models).

| Part No. | Description |
|----------|--|
| 32970-01 | Bar pressure gauge, DIN cylinder connection |
| 32970-02 | Bar pressure gauge, Yoke cylinder connection |
| 32970-11 | Psi pressure gauge, DIN cylinder connection |
| 32970-12 | Psi pressure gauge, Yoke cylinder connection |
| 32970-21 | DIN cylinder connection, No pressure gauge |
| 32970-22 | Yoke cylinder connection, No pressure gauge |



RS4 P+ Regulator

| Part No. | Description |
|----------|------------------|
| 32980-01 | RS4 P+ regulator |



Basic Pressure Gauge

| Part No. | Description |
|----------|-------------|
| 32948-01 | Bar gauge |
| 32948-02 | Psi gauge |

Depth Gauge

| Part No. | Description |
|----------|-----------------|
| 32941-51 | Scale in meters |
| 32941-52 | Scale in feet |

Compass

| Part No. | Description |
|----------|-------------------------|
| 32942-01 | For northern hemisphere |
| 32942-02 | For southern hemisphere |



MKIII REGULATOR

The DIVATOR MKIII Regulator is a unique design with dual first stage regulators integrated into one unit. Therefore it becomes redundant and has an easy-to-use transition between reserve air or bail-out mode with a "Pull for air"-solution. The MKIII Regulator is equipped with a surface supply inlet port for the DP1.

All MKIII Regulators are supplied with: primary breathing hose, Octopus hose and Octopus breathing valve. In addition the MKIII Regulator can be delivered with or without BC and dry suit hoses.

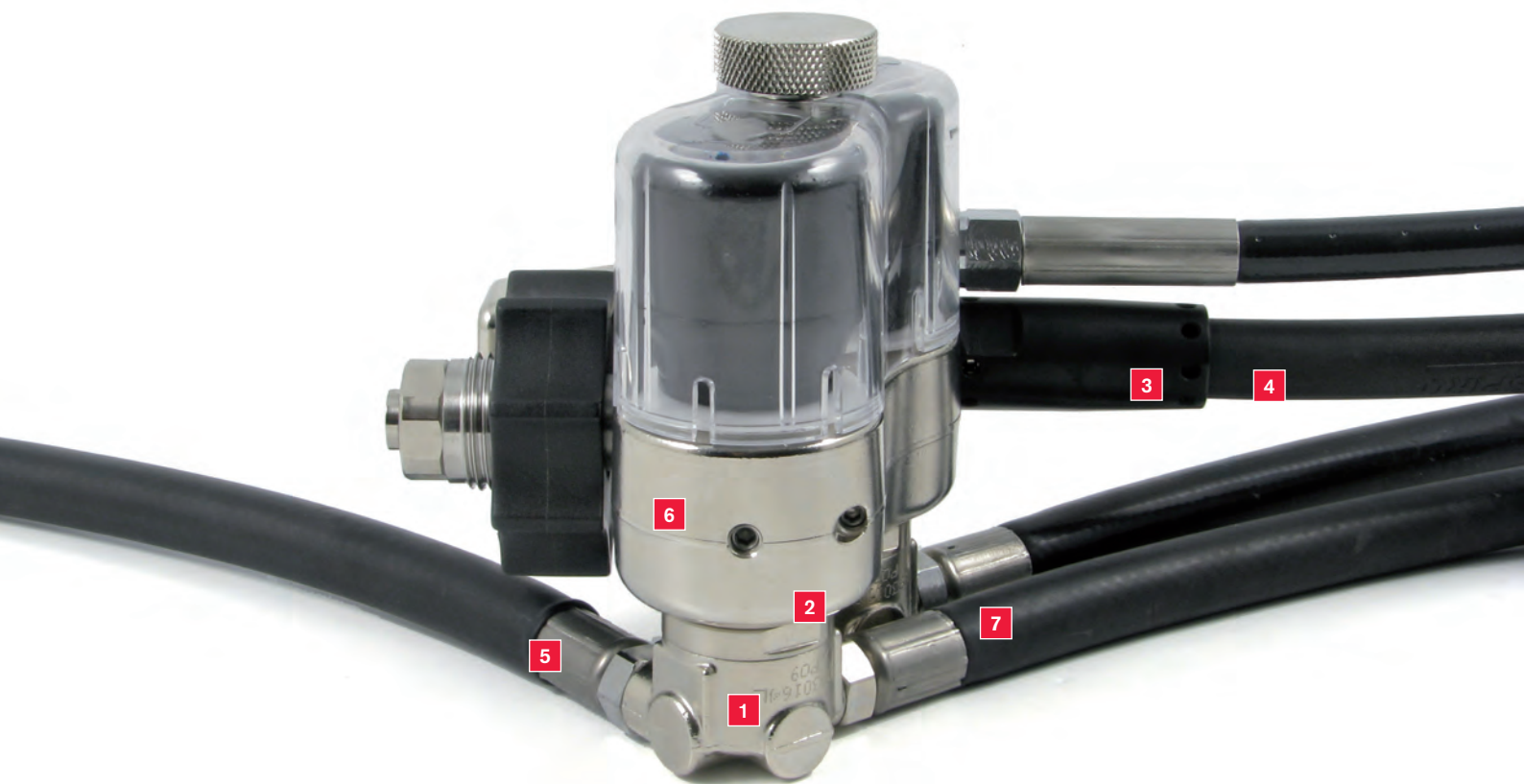

- 1** Dual first stage regulators integrated in one unit, giving the diver several options to handle problematic situations.
- 2** Designed to give the diver at least two breathing sources, two inflation sources and two ways to isolate air loss.
- 3** Safe transition into reserve air mode with "Pull for air"-solution.
- 4** Primary regulator can be closed by "Push" maneuver.
- 5** DP1 surface supply inlet port.
- 6** Integrated "Bail out" function.
- 7** Outlets for connection of BC, dry suit and Octopus.

MKIII REGULATOR

MKIII Regulator - BAR Version

| Part No. | Description |
|----------|--|
| 30026-01 | Regulator with BC hose and dry suit hose (Length of dry suit hose: 0.75 meter / 2.5 ft) |
| 30026-02 | Regulator, plugged (without hoses) |
| 30026-03 | Regulator with BC hose and dry suit hose (Length of dry suit hose: 1 meter / 3.3 ft) |

MKIII Regulator - PSI Version

| Part No. | Description |
|----------|--|
| 30026-06 | Regulator with BC hose and dry suit hose (Length of dry suit hose: 0.75 meter / 2.5 ft) |
| 30026-07 | Regulator, plugged (without hoses) |
| 30026-08 | Regulator with BC hose and dry suit hose (Length of dry suit hose: 1 meter / 3.3 ft) |

Holders & Straps for MKIII Regulator

| Part No. | Description |
|----------|------------------------------|
| 99099-51 | Holder strap, with hose loop |
| 88139-52 | Holder cord with hook |



MKII REGULATOR

The DIVATOR MKII is designed to endure extreme temperatures and is proven by years of trouble free use by professional divers from the arctic to the equator. The easy-to-read pressure gauge and the regulator are approved for use in cold waters.

The MKII can easily be upgraded to a variety of configurations, for instance with a Octopus breathing valve or a dry suit hose. The MKII regulator is ready for use with the DP1 Surface Supply. All regulators are delivered with breathing hose.

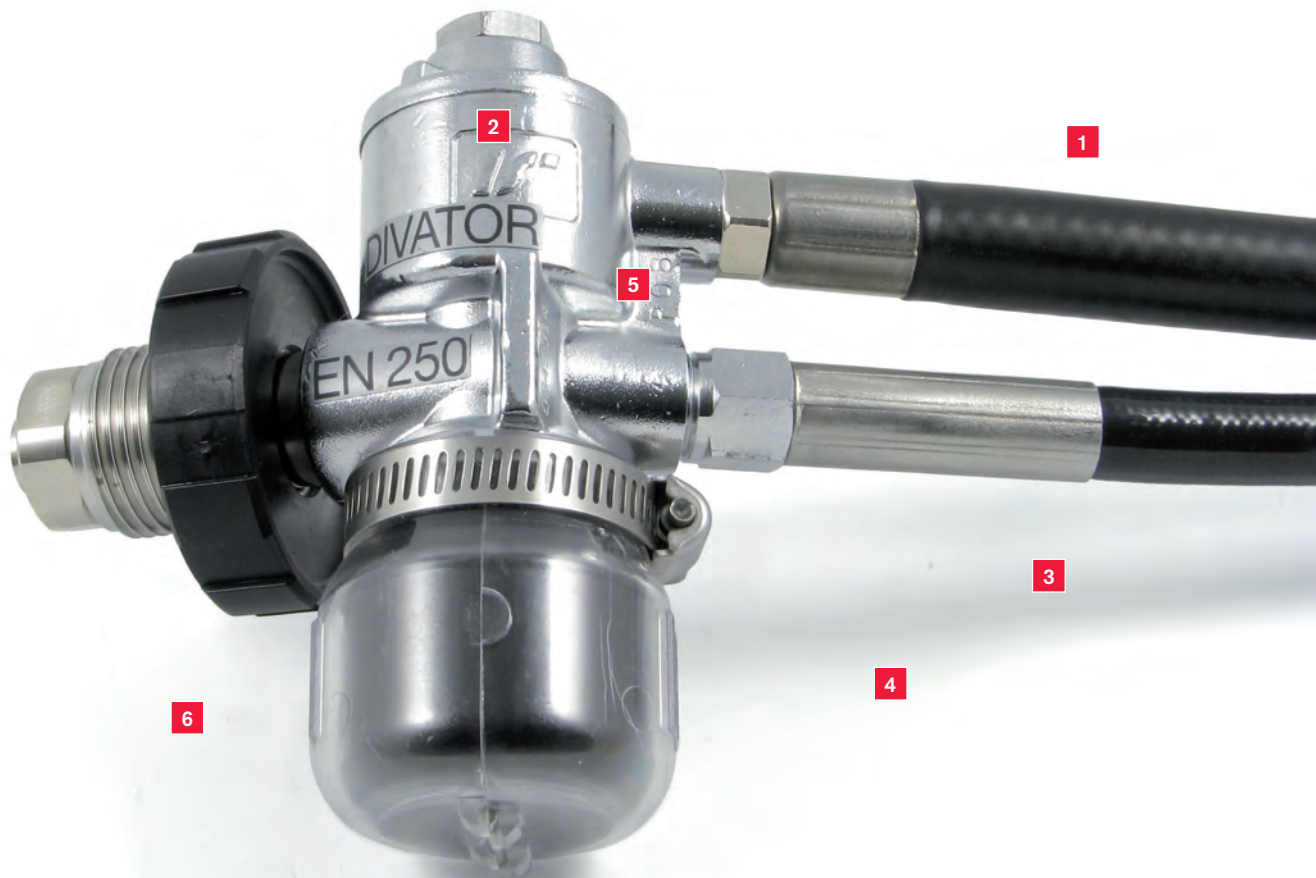

1 Chest mounted reserve valve and surface supply connection.

2 Approved for use in cold waters.

3 The function of the reserve valve can be checked pre-dive.

4 The reserve valve is self-resetting at pressures above 100 bar (1450 psi).

5 Quick connection for external air source such as DP1 surface supply.

6 "Bail out" function is available as optional feature.

MKII REGULATOR

MKII Regulator - BAR Version

The basic MKII regulator version, equipped with a Bar pressure gauge and one low pressure outlet.

| Part No. | Description |
|-----------|---|
| 336191075 | Regulator |
| 336190377 | Regulator with reserve valve |
| 96727 | Regulator with bail out valve. Only for surface supply diving with the DP1. |

MKII Regulator, 4-port swivel - BAR Version

Bar version of the MKII regulator, equipped with a 4-port swivel with four low pressure outlets.

| Part No. | Description |
|----------|---|
| 99083-05 | Regulator with 4-port swivel and reserve valve |
| 99083-06 | Regulator with 4-port swivel, reserve valve and 55 bar HUD |
| 99083-07 | Regulator with 4-port swivel and bail out valve |
| 99083-08 | Regulator with 4-port swivel, bail out valve and 55 bar HUD |
| 99083-09 | Regulator with 4-port swivel |

MKII Regulator, 4-port swivel - PSI Version

The Psi version of the MKII regulator, equipped with a 4-port swivel with four low pressure outlets

| Part No. | Description |
|----------|---|
| 99083-01 | Regulator with 4-port swivel and reserve valve |
| 99083-02 | Regulator with 4-port swivel, reserve valve and 55 bar HUD |
| 99083-03 | Regulator with 4-port swivel and bail out valve |
| 99083-04 | Regulator with 4-port swivel, bail out valve and 55 bar HUD |
| 99083-11 | Regulator with 4-port swivel |

Holders & Straps for MKIII Regulator

| Part No. | Description |
|----------|---------------------------|
| 30824-51 | MKII reserve holder strap |



MKII Regulator
(336191075)



MKII reserve valve
(336190377)



MKII bail out valve
(96727)



4-port swivel



MKII Regulator
with 4-port swivel,
reserve valve and
HUD

CYLINDERS

Interspiro is leading the way towards composite cylinder diving – DIVATOR Lite – which improve ergonomics and simplify logistics combined with excellent balance and neutral buoyancy in the water.

Both the perfectly balanced low-profile steel cylinders and the composite cylinders have the quick attachment system for mounting on a DIVATOR BC or Harness.



DIVATOR LITE COMPOSITE CYLINDERS

Interspiro's DIVATOR LITE, is the first complete professional diving system designed specifically for the search and rescue diver. The DIVATOR LITE Cylinder System combines an ultra lightweight non-metal composite cylinder with a balanced and adjustable weight system. This cylinder system dramatically increases the diver's safety and comfort.

The DIVATOR steel cylinders all have a very low profile and no protruding parts, which reduces the risk of getting caught in obstacles and ensures less water resistance. The cylinder design is robust and suitable for diving in demanding environments.



- 1** Lightest diving cylinders in the world out of water
- 2** Perfectly balanced under water
- 3** Low profile allows for safer access to confined spaces and minimizes resistance in current waters
- 4** Quick cylinder attachment interface to harness or BC
- 5** Removable compensating weight between the cylinders
- 6** The regulator position simplifies cylinder valve handling and the carrying handle protects the regulator
- 7** The first composite cylinder approved by US Department of Transportation (DOT) for underwater use in the United States

DIVATOR LITE COMPOSITE CYLINDERS

DIVATOR LITE Cylinders - PED & CE Approved

| Part No. | Description |
|-----------|--|
| 98853-01 | Cylinder pack 323.4 (2040 L / 72 ft ³) |
| 98855-01* | Cylinder pack 325 (3000 L / 106 ft ³) |
| 98857-01 | Cylinder pack 326.7 (4020 L / 142 ft ³) |
| 98857-04 | Cylinder pack 326.7 with Easy-fill connection, for filling cylinder with a mounted regulator |

*On request, minimum order quantity may be applicable.

DIVATOR LITE Cylinders - DOT Approved

| Part No. | Description |
|----------|--|
| 98853-02 | Cylinder pack 323.4 |
| 98857-02 | Cylinder pack 326.7 |
| 98857-05 | Cylinder pack 326.7 with Easy-fill connection, for filling cylinder with a mounted regulator |

Pre-delivery Cylinder Filling

| Part No. | Description |
|----------|-------------------------------|
| 32300-01 | Pre-delivery cylinder filling |

NOTE! Cylinders are by default delivered without air (only with safety pressure). For delivery of filled cylinders add this item (same quantity as the quantity of cylinders)

Cylinder Pack Handle

| Part No. | Description |
|----------|--------------------------------|
| 31710-51 | Cylinder pack handle |
| 31710-52 | Cylinder pack handle, 10 pack |
| 31710-53 | Cylinder pack handle, 100 pack |



DIVATOR LITE Cylinders - Non-magnetic

| Part No. | Description |
|------------|--|
| 88410-901* | 1 liter 300 bar non-magnetic composite cylinder, Right |
| 88410-905* | 1 liter 300 bar non-magnetic composite cylinder, Left |



*On request, minimum order quantity may be applicable.

DIVATOR LITE Cylinder Weights

| Part No. | Description |
|----------|---|
| 97520-11 | 13.8 kg weight for 326.7 cylinder pack |
| 97520-12 | 11.4 kg weight for 325 or 326.7 cylinder pack |
| 97520-13 | 9.3 kg weight for 323.4 cylinder pack |



Cylinder Weights Accessories

| Part No. | Description |
|----------|---|
| 97869-51 | Weight substitute for 325 or 326.7 cylinder pack |
| 97869-52 | Weight substitute for 323.4 cylinder pack |
| 88199-51 | Handle protection kit for 5 cylinder weights. For mounting on older cylinder weights without handle protection, or as spare part. |



CYLINDER IDENTIFICATION, EXAMPLE:

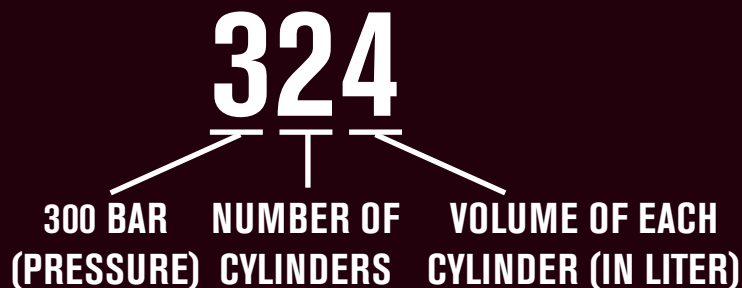

STEEL CYLINDERS

The DIVATOR steel cylinders all have a very low profile and no protruding parts, which reduces the risk of getting caught in obstacles and ensures less water resistance. The cylinder design is robust and suitable for diving in demanding environments.

DIVATOR steel cylinder packs and single cylinders all have an easily accessible cylinder valve and are equipped with a quick connect interface to DIVATOR harness or BCW's.

Steel Cylinder Pack

| | Part No. | Description |
|---|----------|---|
|  | 98412-02 | Cylinder pack 324 PED (2400 L/85 ft ³) |
| | 98412-04 | Cylinder pack 324, Matte Black (2400 L/85 ft ³) |
| | 98411-02 | Cylinder pack 326 PED (3600 L/127 ft ³) |
| | 98411-04 | Cylinder pack 326, Matte Black (3600 L/127 ft ³) |
| | 98411-03 | Cylinder pack 326 with Easy-fill connection, for filling cylinder with a mounted regulator |
| | 98411-05 | Cylinder pack 326, Matte Black with Easy-fill connection, for filling cylinder with a mounted regulator |

Steel Single Cylinder

| | Part No. | Description |
|---|----------|--|
|  | 98445-01 | Single cylinder 316 (1800 L/63 ft ³) |

Pre-delivery Cylinder Filling

| Part No. | Description |
|----------|-------------------------------|
| 32300-01 | Pre-delivery cylinder filling |

NOTE! Cylinders are by default delivered without air (only with safety pressure). For delivery of filled cylinders add this item (same quantity as the quantity of cylinders)

Cylinder Pack Handle

| | Part No. | Description |
|--|----------|--------------------------------|
|  | 31710-51 | Cylinder pack handle |
| | 31710-52 | Cylinder pack handle, 10 pack |
| | 31710-53 | Cylinder pack handle, 100 pack |

EASY-FILL CONNECTION

The Easy-fill connection is designed for filling cylinder packs (composite or steel) that have a mounted regulator.



CARRYING SYSTEM

The DIVATOR BC's or harnesses all have quick connection for attaching the cylinders and also holders for the regulator unit, allow the diver to put the equipment on rapidly and easy.



RESCUE BC

The DIVATOR Rescue BC is a new buoyancy compensator intended for diving in contaminated water, that is approved as a Combined Buoyancy and Rescue Devices (CBRD) – according to the norm EN12628. It is also approved as a buoyancy compensator according to the norm EN1809.

A combined buoyancy and rescue device (CBRD) is defined as an inflatable device that provides the wearer with a buoyancy compensator that also ensures a head up position at the surface even if the wearer is unconscious.

The materials used in the Rescue BC are all easy to clean and this makes the BC easy to decontaminate if needed. The main material of the BC is polyurethane, which is very durable and resistant to wear. Furthermore, the Rescue BC absorbs very little water, which allows it to dry very quickly.



- 1 Approved as a Combined Buoyancy and Rescue Device, CBRD (EN12628) and approved as a Buoyancy Compensator, BC (EN1809)
- 2 Easy to clean and decontaminate, durable and resistant to wear.
- 3 Colored badges that increase visibility of the diver at the surface. The badges are removable and attached with velcro.
- 4 Integrated weight release pockets.
- 5 Quick-drying, absorbs very little water.
- 6 Equipped with MOLLE straps that makes it easy to attach various accessories. (MOLLE = Modular Lightweight Load-carrying Equipment)

RESCUE BC

RESCUE BC for Rail/Cylinder Pack

| Part No. | Description |
|----------|--|
| 88770-02 | Size Small/Medium (S/M), US version |
| 88770-03 | Size Medium/Large (M/L), US version |
| 88770-12 | Size Small/Medium (S/M), with inflation cylinder |
| 88770-13 | Size Medium/Large (M/L), with inflation cylinder |

RESCUE BC for Single Cylinder

| Part No. | Description |
|----------|---------------------------------------|
| 33690-02 | Size Small/Medium (S/M), "US version" |
| 33690-03 | Size Medium/Large (M/L), "US version" |



MOLLE STRAPS

The DIVATOR Rescue BC is equipped with MOLLE straps to enable easy attachment of various pouches and accessories.

MOLLE is an acronym for "Modular Lightweight Load-carrying Equipment".

The MOLLE system is used by a number of NATO armed forces, such as the United States Army and the British Army. The system's modularity is based on rows of heavy-duty webbing stitched onto the BC, which allows for attachment of various MOLLE-compatible accessories.



BCW

The DIVATOR BCW is a buoyancy compensating vest of the wing type that combines high quality heavy duty construction, weight integration, and rear wing style buoyancy. The BCW's modular construction allows the transition between rugged dry suit and thin wet suit diving.

Constructed of heavily reinforced 1050 denier ballistic nylon, the BCW is compatible with a variety of options and accessories, including bladder, pockets and custom gear attachment components.



1 Well integrated interface to the DIVATOR System

4 Integrated weight release system

2 19 kg/44 lbs/180 N lift capacity with standard bladder, other bladder capacities available

5 Heavily reinforced construction with 1050 denier ballistic nylon

3 Available in four sizes, and equipped with fully adjustable shoulder and waist panels

6 Quick cylinder attachment interface

BCW

BCW for Rail/Cylinder Pack

| Part No. | Description |
|----------|---|
| 99095-01 | Size Small (S) |
| 99095-02 | Size Medium (M) |
| 99095-03 | Size Large (L) |
| 99095-04 | Size Extra-Large (XL) |
| 99095-05 | Size Extra-Extra-Large (XXL) |
| 99095-11 | Size Small (S), with inflation cylinder kit |
| 99095-12 | Size Medium (M), with inflation cylinder kit |
| 99095-13 | Size Large (L), with inflation cylinder kit |
| 99095-14 | Size Extra-Large (XL), with inflation cylinder kit |
| 99095-15 | Size Extra-Extra-Large (XXL), with inflation cylinder kit |

BCW for Single Cylinder

| Part No. | Description |
|----------|------------------------------|
| 99354-01 | Size Small (S) |
| 99354-02 | Size Medium (M) |
| 99354-03 | Size Large (L) |
| 99354-04 | Size Extra-Large (XL) |
| 99354-04 | Size Extra-Extra-Large (XXL) |

Sizing Chart - BCW

| SIZE | MEASUREMENTS* |
|------------------|--|
| SMALL (S) | Waist (A): 64-89 cm / 25-35 inch Shoulder to waist (B): 36-46 cm / 14-18 inch |
| MEDIUM (M) | Waist (A): 84-104 cm / 33-41 inch Shoulder to waist (B): 46-56 cm / 18-22 inch |
| LARGE (L) | Waist (A): 94-114 cm / 37-45 inch Shoulder to waist (B): 56-66 cm / 22-26 inch |
| EXTRA-LARGE (XL) | Waist (A): 107-127 cm / 42-50 inch Shoulder to waist (B): 66-74 cm / 26-29 inch |

*Indicative measurements for size to be taken with diving suit donned.

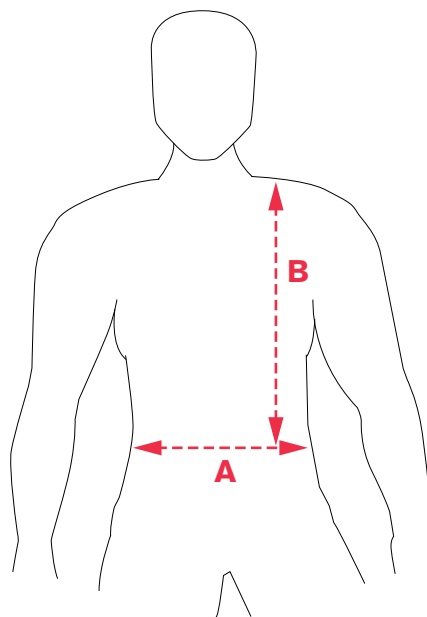

INTEGRATED WEIGHT RELEASE SYSTEM

The DIVATOR BCW is equipped with a fully integrated weight release system.

Two sizes of specially designed Mesh Weight Pouches are available. They can hold any type of buoyancy compensating weights.

The smaller mesh pouch is perfect for use with Interspiro's standard brass weights (450 g/1 lbs) and the larger mesh pouch is suitable for the Weight Holder Kit with room for 9 brass weights.



WEIGHT SYSTEM

The DIVATOR System Weight is Interspiro's multi-purpose environmentally friendly brass weight that can be used for a wide range of applications.

System Weight

| | Part No. | Description |
|---|-----------|--|
|  | 88174-51 | Weight, 450 gram (1 lbs) |
| | 88174-951 | Weight, 450 gram (1 lbs), non-magnetic |

Chest Weight Pocket / Belt Weight Pocket

| | Part No. | Description |
|---|-----------|--|
|  | 88135-01 | Weight pocket without weights |
| | 88175-51 | Weight pocket with two weights |
| | 88135-951 | Weight pocket without weights, non-magnetic |
| | 88175-951 | Weight pocket with two weights, non-magnetic |

Weight Holder Kit















| | Part No. | Description |
|---|-----------|--|
|  | 88350-51 | Weight holder kit for BC without weights |
| | 30057-51 | Weight holder kit for BC with 9 weights |
| | 88350-951 | Weight holder kit for BC without weights, non-magnetic |
| | 30057-951 | Weight holder kit for BC with 9 weights, non-magnetic |

Leg Weight Pocket

| | Part No. | Description |
|---|-----------|---|
|  | 460190863 | Leg weight pocket without weights |
| | 88194-51 | Leg weight pocket with 5 weights |
| | 30251-951 | Leg weight pocket without weights, non-magnetic |
| | 88194-951 | Leg weight pocket with 5 weights, non-magnetic |

BCW & BC ACCESSORIES

BCW & BC Accessories

| | Part No. | Description |
|--|-----------|--|
|  | 30046-51 | Saddle Strap (crotch strap) securing the BCW/BC from moving up. |
|  | 30049-01 | Spare Air Pouch, suitable for one 0.35 liter 300 bar cylinder |
|  | 30050-01 | Pony Bottle Pouch, for ~1 liter (6 cu/ft) 200/300 bar pony bottle |
|  | 30147-01 | Zip Mount Adapter, pair (left & right). For attachment of spare air or pony bottle pouch |
|  | 460190923 | Velcro holders (pair, left & right) |
|  | 30411-51 | BC inflation hose UNF 3/8, 1.15 meter (45"), for MKII & MKIII |
|  | 30411-52 | BC inflation hose UNF 3/8, 1.28 meter (50") |
|  | 30411-53 | BC inflation hose UNF 3/8, 0.51 meter (20"), for single cylinder |
|  | 30411-54 | BC inflation hose UNF 3/8, 0.75 meter (29") |
|  | 30201-01 | Inflation Kit, complete kit including cylinder (0.35 liter 300 bar) |
|  | 30201-02 | Inflation Kit, without cylinder (0.35 liter 300 bar) |
|  | 30146-01 | Aluminium cylinder, 0.35 liter 300 bar (4350 psi) (Not DOT approved) |
|  | 30047-01 | Mesh Weight Pouch ~8 kg (18 lbs) for BCW. For weight holder kit, or standard weights. |
|  | 30048-01 | Mesh Weight Pouch ~5 kg (12 lbs) for BCW. For standard diving weights. |
|  | 95449-01 | BC Single Cylinder Strap Kit |

HARNESS

The DIVATOR Harness is ergonomically designed and takes the weight load from the cylinder pack off the shoulders and spreads the weight evenly out on the divers back. The belt coupling has a quick release function and is self centering which makes the belt coupling easy to find. It is easy to mount and dismount the cylinder pack to the harness. It requires no tools.

Harness

| Part No. | Description |
|-----------|---|
| 336190975 | For cylinder pack |
| 336190976 | For single cylinder with 100 - 140 mm diameter |
| 336190977 | For single cylinder with 140 - 183 mm diameter |
| 30650-01 | Harness Pro, with stainless steel D-rings, Velcro straps and bungee cords |
| 97430-02 | With stainless steel adjustment buckles on shoulder straps and waist belt |
| 336190837 | Single cylinder mounting kit for 100 - 140 mm diameter |
| 336190839 | Single cylinder mounting kit for 140 - 183 mm diameter |



30650-01



97430-02



336190977 / 336190976

336190839,
336190837

DP1 SURFACE SUPPLY

The DIVATOR DP1 surface supply hose provides a truly light weight and portable surface supply. The DP1 provide full cylinder pressure to the diver at depth.

DP1 SURFACE SUPPLY

The DIVATOR DP1 is a unique system with a supply hose that provides a truly light weight and portable surface supply. The DP1 provide full cylinder pressure to the diver at depth. DP1 is designed for use with all Interspiro regulators.

The supply hose itself is very strong but lightweight. At only 10 mm (0.39 inch) in diameter, 60 meters (200 feet) of hose weighs less than 5 kilos (11 lbs) resulting in less storage space, lower carry weight and far less drag in swift water.



1 No need for manual adjustment of pressure for various depths which relieves the attendant's work load.

2 The surface supply is simplified so that the attendant can focus on the safety of the diver.

3 The light and compact design allows rapid deployment when operating in remote or difficult terrain.

4 The small diameter of the lightweight supply hose greatly reduces resistance in current waters.

DP1 SURFACE SUPPLY

DP1 Surface Panel

| Part No. | Description |
|----------|---|
| 96710-51 | DP1 Surface Panel, with Bar pressure gauge. Including belt, vent handle and "OPEN" tag. |
| 96710-53 | DP1 Surface Panel, with Psi pressure gauge. Including belt, vent handle and "OPEN" tag. |



DP1 Supply Hose, including P+regulator

| Part No. | Description |
|----------|---|
| 96725-01 | 60 meter hose (200 ft) |
| 96725-02 | 70 meter hose (230 ft) |
| 96725-03 | 30 meter hose (98 ft) |
| 96725-04 | 120 meter hose (394 ft) |
| 96725-05 | 10 meter hose (33 ft) |
| 96725-06 | 90 meter hose (295 ft) |
| 96725-07 | 80 meter hose (266 ft) |
| 96725-08 | 230 feet hose (70 m) with communication cable (without connectors) and sleeve |
| 96725-09 | 98 feet hose (30 m) with communication cable (without connectors) and sleeve |
| 96725-10 | 200 feet hose (60 m) with communication cable (without connectors) and sleeve |



DP1 Second Diver Take-out Kit

| Part No. | Description |
|----------|--|
| 30102-01 | Kit including T-connection, vent handle, carabiner hook, safety belt and holder strap with hook. |



DP1 Accessories

| Part No. | Description |
|-----------|---|
| 30030-51 | T-connection (straight) for connection of two divers, to one Surface Panel. |
| 97373-51 | Vent, pressure relief and protective handle. Male IS connection |
| 336921843 | Carabiner hook, stainless steel 316 |
| 96741-51 | Safety belt |
| 88139-51 | Holder strap with hook |
| 97335-51 | "OPEN" tag, for marking open cylinder |



DP1 Holdall & Hose Winding Frame

| Part No. | Description |
|-----------|---|
| 336950317 | Holdall for DP1 hose with winding posts. Fits up to a 60 meter DP1 hose. |
| 96745-12 | Hose Winding Frame, light-weight with rubber fastening straps (fits in transportation box 30798-01,-02) |



DP1 Transport Boxes

| Part No. | Description |
|----------|--|
| 30798-01 | Box for < 70 meter DP1 hose, with interior and space for surface box or one cylinder pack. |
| 30798-02 | Box for > 70 meter DP1 hose, without interior but space for surface box. |



IBSOPHONE











The Interspiro Ibsophone tethered under water communication system provides for excellent voice communication between the divers (two) and the surface attendant. The Ibsophone contributes to a high degree of diver safety and also improves his underwater work. When connectors are removed from the amplifier the unit is switched off. Uses six standard 1,5 Volt C Baby/LR14/AM2 batteries for power.

Ibsophone MTIII - for One or Two Divers*

| Part No. | Description |
|-----------|---|
| 336300072 | Including Amplifier, Headset tender (light), 2 x Microphone diver, 2 x Bone conductor diver, 2 x Female Subconn "Red Ring". |

* Lifeline or cable not included.

Parts and Accessories MTIII

| Part No. | Description |
|---|--|
|  336300071 | Amplifier (batteries not included) |
|  30518-51 | Headset tender, Light |
|  336290955 | Microphone diver, to DIVATOR full face mask |
|  88960-01 | OTS Microphone DIVATOR |
|  336290957 | Bone conductor diver, yellow |
|  336921848 | Subconn "Red Ring" - Male |
|  336921845 | Subconn "Red Ring" - Female |
|  30524-01 | Bone conductor diver, deep diving over 60 m, red |
|  336290952 | Headset tender, Peltor |
|  30709-51 | Bone conductor pouch |

Lifelines to MTIII - Floating

Complete floating lifeline made of Poly Propylene, Ø12.5 mm.

| Part No. | Description |
|--|------------------------------|
|  30526-01 | Floating lifeline, 50 meter |
| 30526-02 | Floating lifeline, 60 meter |
| 30526-03 | Floating lifeline, 80 meter |
| 30526-04 | Floating lifeline, 120 meter |

Lifelines to MTIII - Neutral

Complete neutral lifeline made of Poly Propylene, Ø10.5 mm.

| Part No. | Description |
|--|-----------------------------|
|  30527-01 | Neutral lifeline, 50 meter |
| 30527-02 | Neutral lifeline, 60 meter |
| 30527-03 | Neutral lifeline, 80 meter |
| 30527-04 | Neutral lifeline, 120 meter |

Communication Cable to MTIII

Only to be used and wound on a DP1 Surface Supply Hose



| Part No. | Description |
|--|--|
|  33559-15 | Communication cable, 20 meter for DP1 10 meter |
| 33559-13 | Communication cable, 40 meter for DP1 30 meter |
| 33559-11 | Communication cable, 70 meter for DP1 60 meter |
| 33559-12 | Communication cable, 80 meter for DP1 70 meter |
| 33559-17 | Communication cable, 90 meter for DP1 80 meter |
| 33559-16 | Communication cable, 100 meter for DP1 90 meter |
| 33559-14 | Communication cable, 130 meter for DP1 120 meter |

Ibsophone MTIII Transport Box

| Part No. | Description |
|--|--|
|  97445-51 | Box holds one set of Ibsophone MTIII (336300072) with storage space for spare batteries. |

ACCESSORIES

Breathing Hoses & Connections

| Part No. | Description |
|--|--|
|  460190560 | Breathing hose, 750 mm (29") standard |
|  88119-51 | 90 degree breathing hose connection with swivel function |
|  336190389 | Breathing hose UNF 3/8, 725 mm (28"), US |



Dry Suit Inflation Hoses

| Part No. | Description |
|--|--|
|  97474-51 | Cejn 221 - G 1/8 locked, 550 mm (21") |
| 97474-61 | Cejn 221 - G 1/8 unlocked, 550 mm (21") |
| 97474-52 | Cejn 221 - G 1/8 locked, 750 mm (29") |
| 97474-62 | Cejn 221 - G 1/8 unlocked, 750 mm (29") |
| 97474-53 | Cejn 221 - UNF 3/8 locked, 750 mm (29") |
| 97474-63 | Cejn 221 - UNF 3/8 unlocked, 750 mm (29") |
| 97474-54 | Cejn 221 - UNF 3/8 locked, 1 meter (39") |
| 97474-64 | Cejn 221 - UNF 3/8 unlocked, 1 meter (39") |

Octopus or Breathing Hoses

| Part No. | Description |
|---|---|
|  99007-51 | Octopus hose UNF 3/8, 1.7 meter (70") |
| 99007-52 | Octopus hose UNF 3/8, 1.13 meter (44") |
| 99007-53 | Octopus hose UNF 3/8, 1 meter (39") |
| 99618-51 | Octopus hose UNF 3/8, 0.827 meter (32") |
| 88198-61 | Octopus hose G 1/8, 1.1 meter (43") |
| 460190360 | Octopus hose G 1/8, 1.35 meter (53") |

Octopus Holders

| Part No. | Description |
|---|--|
|  88115-51 | Octopus holder clip (5 pack) |
|  30643-51 | Octopus hose holder kit, for harness or BC (pair) |
|  30780-01 | Octopus mouthpiece holder kit (incl. Velcro strap) |
| 30776-51 | Velcro straps for mouthpiece holder kit, 10 pack |

LOCKED / UNLOCKED SUIT INFLATION HOSE

LOCKED:

The lock ring is locked and can not be screwed towards the connector.
Use when there is a need to disconnect the hose from the dry suit during a dive.

UNLOCKED:



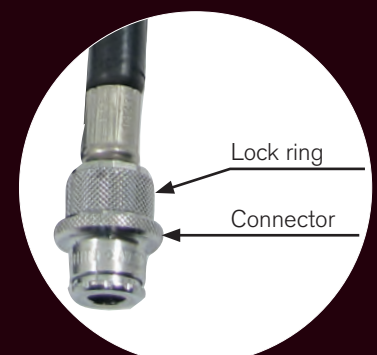

The lock ring is unlocked and can be screwed towards the connector.
This will lock the hose to the dry suit. Securing it from being removed during the dive.



ACCESSORIES

Swivels, Adapters & Connections

Connectors mainly suited for MKII regulator

| | Part No. | Description |
|---|-----------|--|
|  | 98884-51 | Swivel twin outlet G 1/8 male – 2 x UNF 3/8 |
|  | 30051-01 | Swivel single outlet G 1/8 male – UNF 3/8 female |
|  | 30051-02 | Swivel single outlet G 1/8 male – G 1/8 female |
|  | 460190716 | Adapter G 1/8 male – UNF 3/8 female |
|  | 30182-51 | Adapter G 1/8 female – 3/8 UNF male |





Filling Accessories

| | Part No. | Description |
|---|-----------|---|
|  | 331190627 | Air filling hose 300 > 200 Bar, DIN 5/8 |
|  | 99404-03 | Air filling hose 300 > 300 Bar, DIN 5/8 |
|  | 99369-01 | Filling restrictor adapter, 90 degree angle |
|  | 99804-01 | Control gauge, with Bar scale, DIN 5/8 |
|  | 99804-02 | Control gauge, with Psi scale, DIN 5/8 |
|  | 460190770 | Discharge plug (DIN). Controlled, will leave 2 bar (29 psi) safety pressure |



Protective Caps

| | Part No. | Description |
|---|-----------|--|
|  | 460190557 | Plastic protective cap R 5/8 (yellow), 10 pack |
|  | 31391-51 | Dust cover, small, Ø 10-12mm, 10 pack |
|  | 31392-51 | Dust cover, large, Ø 22-26mm, 10 pack |
|  | 95198-51 | Protective plug R 5/8, brass |
|  | 460190077 | Protective plug R 5/8, brass, 5 pack |

Plugs

| | Part No. | Description |
|--|-----------|--------------------------------------|
|  | 460190220 | Cylinder valve plug G 5/8 |
|  | 97192-51 | Blind plug 7/16" |
|  | 460190755 | Plug hex socket head UNF 3/8, 2 pack |
|  | 460190418 | Plug hex head G 1/8 |
|  | 336200721 | Plug hex head UNF 3/8 |



Compounds

| | Part No. | Description |
|---|-----------|---|
|  | 460200058 | Krytox GPL-205, oxygen compatible 57g (2oz) |
|  | 331900268 | Lubricant for high pressure cylinder valves |
|  | 331900269 | Silicone lubricant, for low pressure applications |

Test Equipment

| | Part No. | Description |
|---|-----------|-------------|
|  | 336190128 | Mini Test |

Transport Boxes

| | Part No. | Description |
|---|----------|--|
|  | 30977-01 | For DIVATOR diving equipment with interior for one 323.4 and one 326.7 and additional space for regulator, mask, BC etc. |
|  | 30798-01 | DP1 Transport Box for < 70 meter DP1 hose, with interior and space for surface box or one cylinder pack. |
|  | 30798-02 | DP1 Transport Box for > 70 meter DP1 hose, without interior but space for surface box. |
|  | 97445-51 | Ibsophone Transport Box, holds one set of Ibsophone MTIII (336300072) with storage space for spare batteries. |

CANISTER LIGHT

DIVATOR Canister Light

| Part No. | Description |
|----------|--|
| 33342-01 | Canister Light EU (incl. EU plug) |
| 33343-01 | Canister Light US (incl. US & EU plug) |
| 33344-01 | Canister Light UK (incl. UK & EU plug) |

Included parts:

- Battery Canister (with Li-ion batteries)
- Lamp Body with LED Lamp Head
- Lamp Holder (with slide)
- AC Cable with Plug(s)
- Battery Charger (100 - 240 V, 50/60 Hz)
- Cable Adaptor (for Battery Canister charging)
- Rail Holder (for DIVATOR Full Face Mask)
- Battery Pouch
- Zip Mount Adaptors (left & right)
- Soft Dry Bag



Interspiro has over 90 years of experience as a groundbreaking innovator of respiratory protection for non-breathable environments. Interspiro is a supplier of respiratory protection to defense military organizations, fire and rescue services, industries, utilities, shipping and diving companies around the world. Interspiro is an Ocenco Group company. Ocenco ranks among the world's largest respiratory protection companies.

Central Europe

AUSTRIA

Interspiro GesmbH
Fürstenfelderstrasse 35
A-8200 Gleisdorf
Austria
Tel +43 (0)311 236 133
Fax +43 (0)311 236 133 22
E-mail info@interspiro.at

GERMANY

Interspiro GmbH
Fangdieckstr. 22
D-22547 Hamburg
Germany
Tel ++49 40 300315170
Fax +49 40 3003151720
E-mail info@interspiro.de

SWITZERLAND

Interspiro AG
Güterstrasse 47
CH-4133 Pratteln
Switzerland
Tel +41 61 827 99 77
Fax +41 61 827 99 70
E-mail infoch@interspiro.com

THE NETHERLANDS

Interspiro BV
Operetteweg 35
NL-1323 VK Almere
Netherlands
Tel +31 (0)36 536 31 03
Fax +31 (0)36 538 48 09
E-mail infobv@interspiro.com

North & South America

Interspiro Inc.
10225 82nd Avenue
Pleasant Prairie, WI 53158-5801
USA
Tel +1 262 947 9901
Fax +1 262 947 9902
E-mail info@interspiro.com

United Kingdom & Ireland

Interspiro Ltd.
7 Hawksworth Road | Central Park
Telford | Shropshire TF2 9TU
United Kingdom
Tel +44 (0)1952 200 190
Fax +44 (0)1952 299 805
E-mail infouk@interspiro.com

Sweden, Export & Asia/Pacific

Sweden & Export
Box 2853
SE-187 28 Täby
Sweden
Tel +46 8 636 51 00
Fax +46 8 636 51 99
E-mail info@interspiro.com

Interspiro Sdn Bhd
NO: 14-A, Jalan Tiara 3, Tiara
Square | Taman Perindustrian
Sime UEP | 47600 Subang Jaya,
Selangor | Malaysia
Tel +603-802 482 21
E-mail asiapacific@interspiro.com