

KARTSANA

Life-moving innovation

GENERAL CATALOGUE

Design and manufacture of emergency service equipment

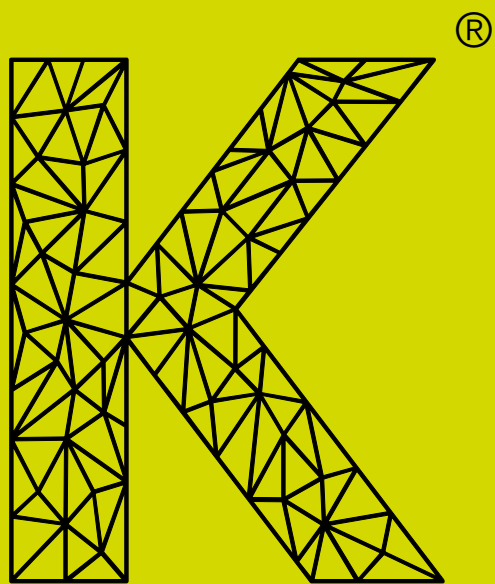

KARTSANA 2

ELECTRICAL EQUIPMENT

01 · BRAVA SERIES	8
02 · SILVER SERIES	12
03 · CHEROKEE SERIES	16

MECHANICAL EQUIPMENT

01 · JUPITER COMPACT SERIES	20
02 · JUPITER TROLLEY STRETCHER SERIES	24
03 · 241 COMPACT SERIES	28
04 · RAILS	34
05 · EVACUATION CHAIRS	38

SPECIAL EQUIPMENT

01 · INCUBATOR STRETCHERS	42
02 · REMOVAL STRETCHERS	46
03 · ACCESSORIES	48

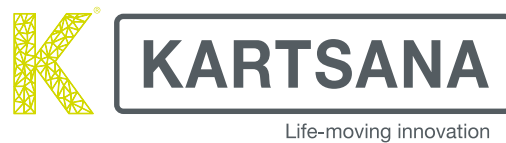

We are a company devoted to designing, manufacturing and distributing equipment for emergency transport and healthcare services.

Our products stand out for their reliability, their manoeuvrability and their careful and solid design which guarantees the security of both professionals and patients.

From our factory in Barcelona, we operate in more than 28 countries, fully adapting to the particular circumstances and regulations of each market.

KARTSANA



5 values for going further



INNOVATION AND DESIGN

Every detail is carefully designed to create products with a solid yet manageable structure.



EUROPEAN QUALITY

We guarantee the quality and reliability of our products by creating and manufacturing them in Europe.



A history of effort, improvement and evolution

Modesto Luengo founded KARTSANA in 1986.

Working in an ambulance and seeing first-hand the needs of both paramedics and patients, experiencing the hands-on nature of the work, the difficulty of handling transport equipment and a desire to improve the way things were all drove his founder to set up his own business. Ever since then, his goal has been to create unique products which meet the real needs of paramedics and patients.

Every stretcher and bed created by KARTSANA is a reflection of the founder's attitude, which he has passed on to his entire team: real experience, obsession over design and non-conformism in order to keep improving each day.

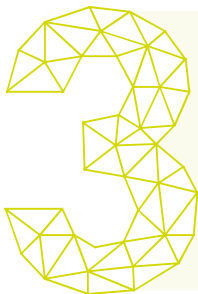

ABILITY TO ADAPT

We operate in more than 28 countries and adapt to each one's individual needs and regulations.

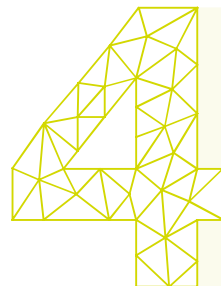

PRACTICALITY

Solutions that make work easier for professionals without compromising the patient's well-being.

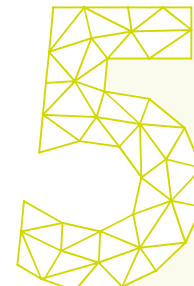

RENEWED EXPERIENCE

Committed to our clients, we strive to improve day in and day out.

Equipment designed for practicality above all else



R&D AND OPTIMAL DESIGN

The capacity to research and develop new features helps us offer innovative solutions for even the most demanding needs.

RELIABILITY AND SAFETY

Stretchers designed with a solid, strong and resistant structure to provide maximum safety to both paramedics and patients.

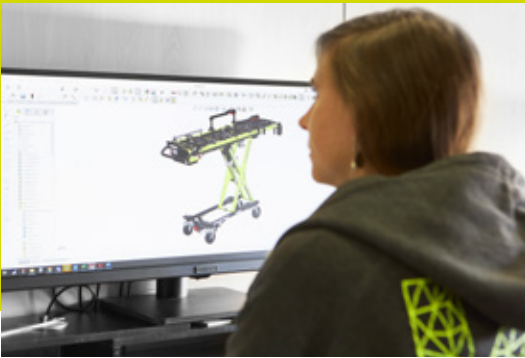

People who transport people

Emergency healthcare transportation carries with it a huge responsibility. It is performed by people working with and for other people, often in difficult and highly stressful situations.

KARTSANA's transport equipment is designed to help professionals and make their job easier while respecting the patient's comfort.

We draw on our 37 years of experience to innovate and seek an optimal structural design which allows us to offer a wide range of stretchers and chairs that are reliable, easy to handle and safe, with an unbeatable price-quality ratio.

EASE OF USE

Equipment with exceptional manoeuvrability, facilitating healthcare professionals' movement with minimal effort. Light and ergonomic.

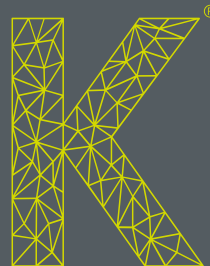

KARTSANA



300kg
MAX WEIGHT
MAX PESO

KARTSANA





ELECTRICAL

ELECTRICAL EQUIPMENT

01 · BRAVA SERIES	8
02 · SILVER SERIES	12
03 · CHEROKEE SERIES	16





BRAVA SERIES

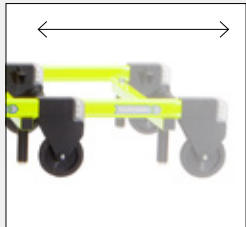

Control, comfort and safety

Top-of-the-range high-autonomy electric stretchers equipped with a number of features for handling with ease.



- | | | | | | |
|---|---|--|---|--|--|
| <p>01
300 kg unassisted
Stretcher with a hydraulic elevation system which can lift loads of up to 300 kg unassisted.</p>  | <p>02
Telescopic frame
The headrest area features a telescopic frame to facilitate manoeuvring in places with difficult access.</p>  | <p>03
Unlocking pedal
Wheels are unlocked using a single pedal to give the operator maximum control.</p>  | <p>04
Control panel
New and improved control panel, now more intuitive, autonomous and functional.</p>  | <p>05
Emergency lights
For increased safety.</p>  | <p>06
Maximum autonomy
Features 2 batteries for guaranteed autonomy.</p>  |
|---|---|--|---|--|--|

A! ACCESSORIES: for BRAVA SERIES accessories, see pages 48, 49 and 50.

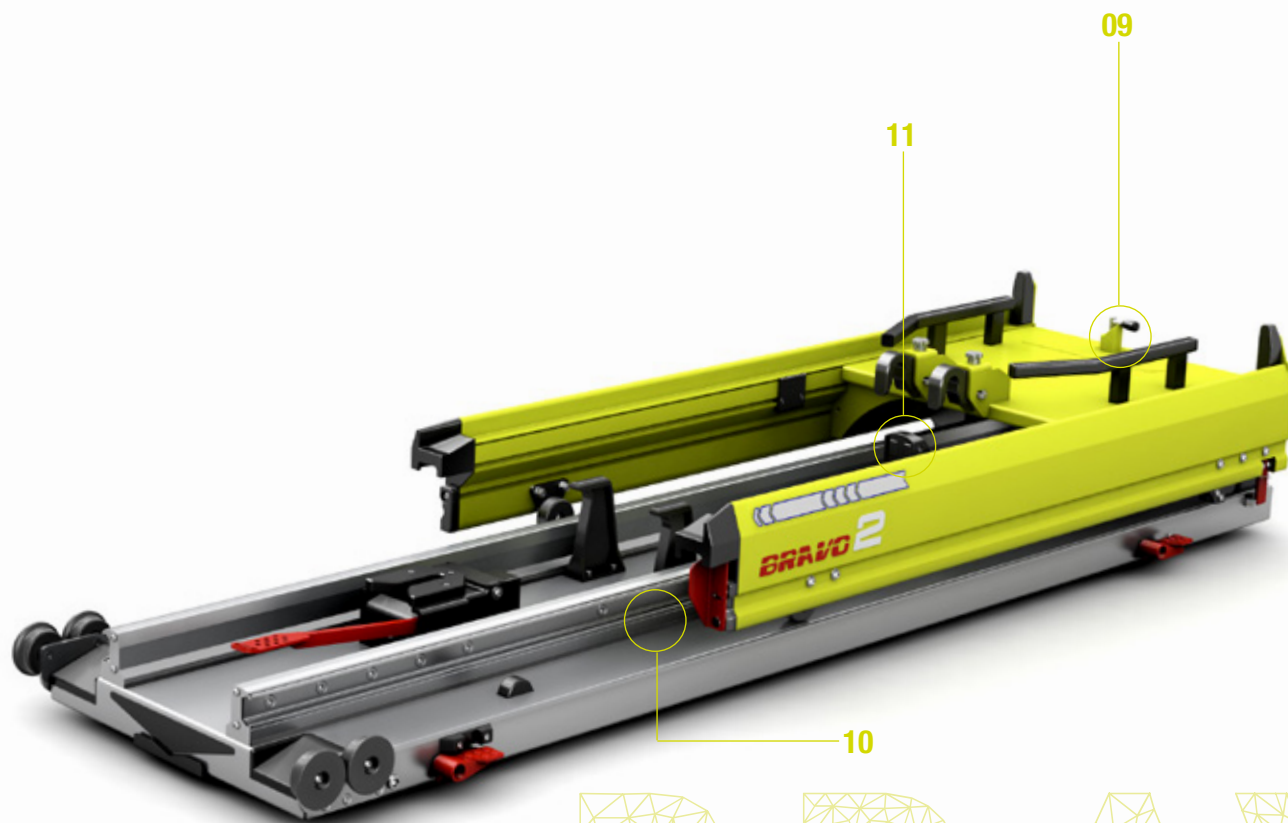
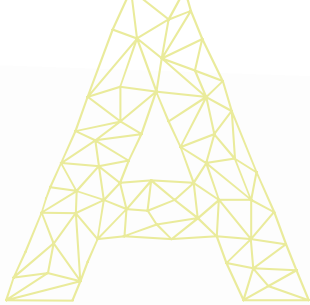

BRAVA

The range of rails for the BRAVA stretcher

Product certification

All KARTSANA products comply with the EN 1865 and 1789 standards.

CERTIFIED
10G

07

Lateral movement

To optimise space in the ambulance and make work easier.



08

Backboard stretcher drawer

The R-1002C model can store a backboard or scoop stretcher.



09

CPR lock

Special lockable position for performing CPR inside the ambulance with greater comfort.



10

Telescopic

Easy to load.

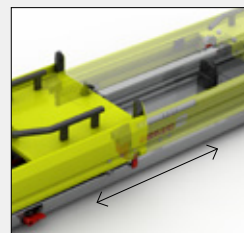

11

Integrated battery-charging system

Batteries charge automatically when inside the ambulance.



TG-1000 POWER BRAVA

- ▷ Control the stretcher from the operator's position.
- ▷ Adjustable headrest with shock absorber.
- ▷ Double-jointed leg rest with 2 shock absorbers.
- ▷ 4 ø160 mm rotating wheels. (2 remote-lockable wheels via pedal).
- ▷ Laterally and longitudinally collapsible guardrails.
- ▷ Three-point safety belt kit and IV pole.
- ▷ Aluminium tray for performing cardiac massages.
- ▷ The head area features a telescopic frame to facilitate manoeuvring in places with difficult access.
- ▷ Hydraulic system unlocking button in case of fault.



Neonates
(see page 40)



Bariatric kit
(see page 48)



The headrest area features a telescopic frame to improve manoeuvrability

DIMENSIONS AND WEIGHT

	TG-1000
H Max. height (mm)	1300
HC Max. adjustable height (mm)	1030
H2 Min. height (mm)	350
L Length (mm)	1972
L2 Length closed (mm)	1610
L3 Length open (mm)	2100
W Width (mm)	574
Load capacity (kg)	300
Weight (kg)	74

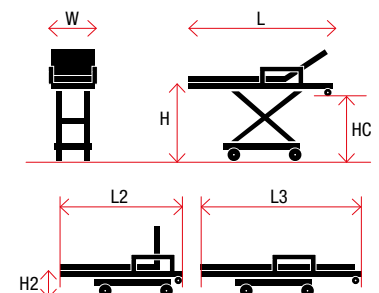

R-1002A BRAVO

- ▷ Telescopic BRAVO loading system with lateral movement.
- ▷ Certified 10G.



R-1001 BRAVO

- ▷ BRAVO loading system.
- ▷ Certified 10G.

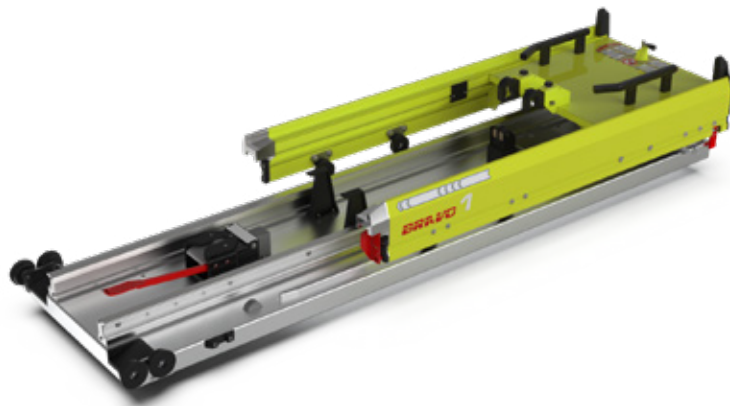

R-1002C BRAVO

- ▷ BRAVO 2 loading system, with a drawer for storing a backboard stretcher.
- ▷ Certified 10G.

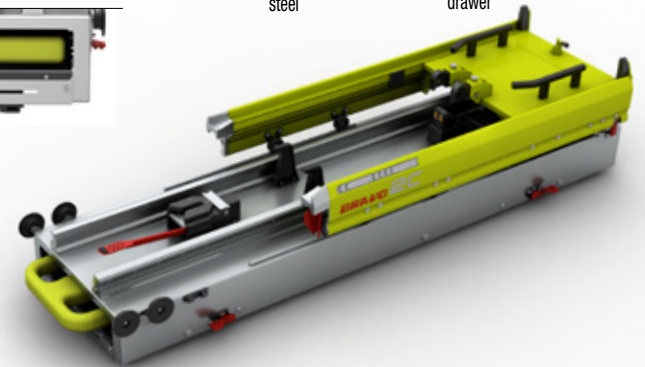
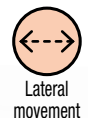

DIMENSIONS AND WEIGHT

	R-1001	R-1002A	R-1002C
H Height (mm)	340	360	460
L Length closed (mm)	2050	2065	2088
L2 Length open (mm)	3090	3130	3145
W Width (mm)	590	632	632
A2 Height rail + stretcher (mm)	509	535	620
Weight (kg)	89	103	117

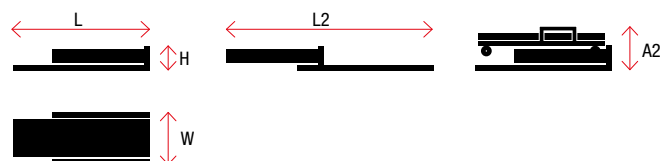

SILVER SERIES



Strong and light, the perfect balance

Electric stretchers with an excellent design that guarantees comfortable yet safe handling.



01

230 kg

Stretcher with a hydraulic elevation system which can lift loads of up to 230 kg unassisted.



02

Unlocking pedal

Wheels are unlocked using a single pedal to give the operator maximum control.



03

Control panel

New and improved control panel, now more intuitive, autonomous and functional.



04

Easy to transfer patients

Laterally and longitudinally collapsible guardrails.

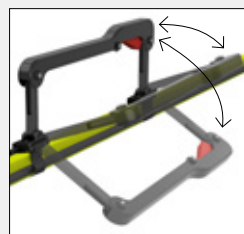

Product certification

All KARTSANA products comply with the EN 1865 and 1789 standards.



A! ACCESSORIES: for SILVER SERIES accessories, see pages 48, 49 and 50.

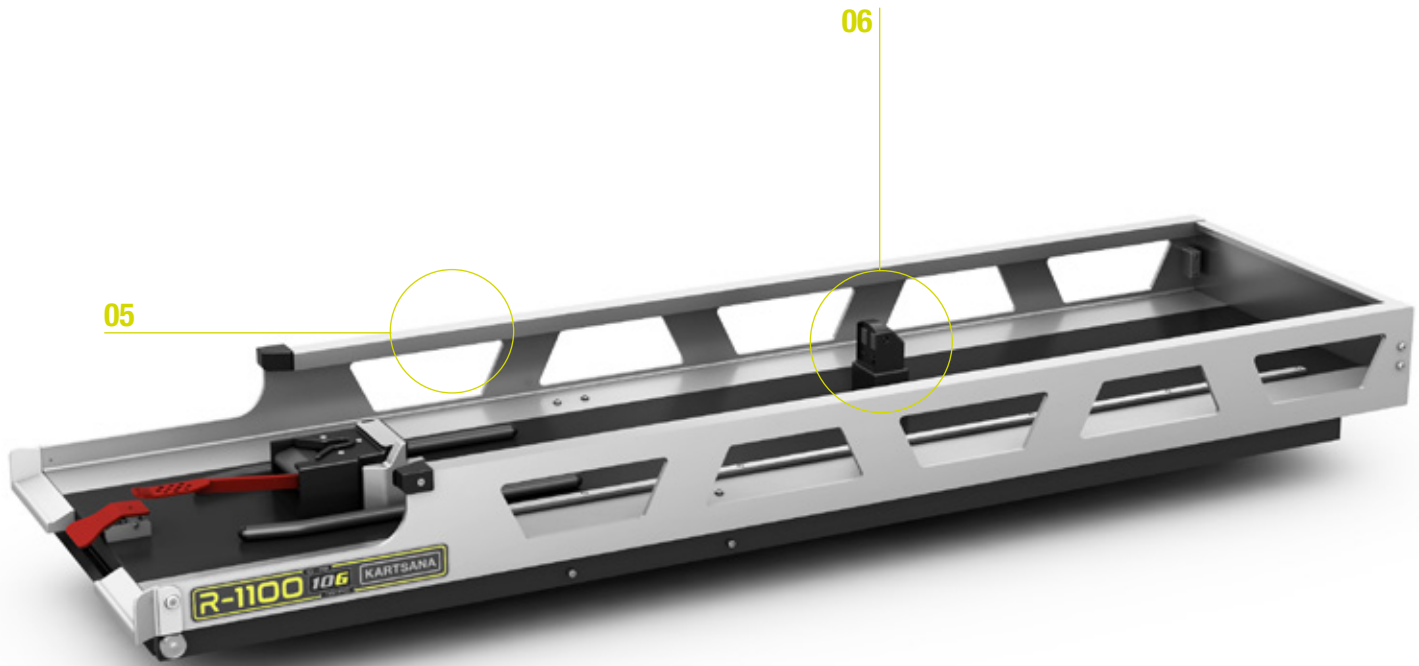
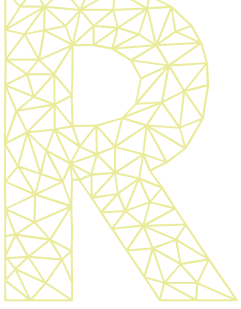

R-1100, the rail for the SILVER stretcher

05

New design

Now even lighter.



06

Integrated loading system

Batteries charge automatically when inside the ambulance.



TG-1100 2 / TG-1100 4

- ▷ Adjustable headrest with shock absorber.
- ▷ Single-jointed leg rest with shock absorber.
- ▷ **TG-1100 2**: 2 rotating wheels with brakes + 2 fixed ø160 mm wheels.
- ▷ Guardrails that collapse laterally and longitudinally outwards.
- ▷ Folding IV pole.
- ▷ Three-point safety belt kit.
- ▷ Aluminium tray for performing cardiac massages.
- ▷ Hydraulic system unlocking button in case of fault.
- ▷ **TG-1100 4**: 4 rotating wheels (2 with brakes + 2 lockable wheels).



Aluminium



Electric



230 kg



Minimal effort
for the healthcare
worker



DIMENSIONS AND WEIGHT

		TG-1100 2 / TG-1100 4
H	Max. height (mm)	1135
HC	Max. adjustable height (mm)	786
H2	Min. height (mm)	350
L	Length (mm)	1955
W	Width (mm)	566
	Load capacity (kg)	230
	Weight (kg)	69

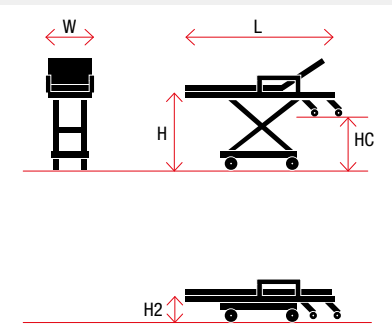

R-1100

- ▷ Rail for the TG-1100 SILVER stretcher.
- ▷ Extends out of the rear of the ambulance to load the stretcher.
- ▷ Manual operation on two guide tracks.
- ▷ Rail mainly made from aluminium and steel.
- ▷ 3 solid anchoring points to the stretcher.

AI
Aluminium
and stainless
steel

CERTIFIED
10G

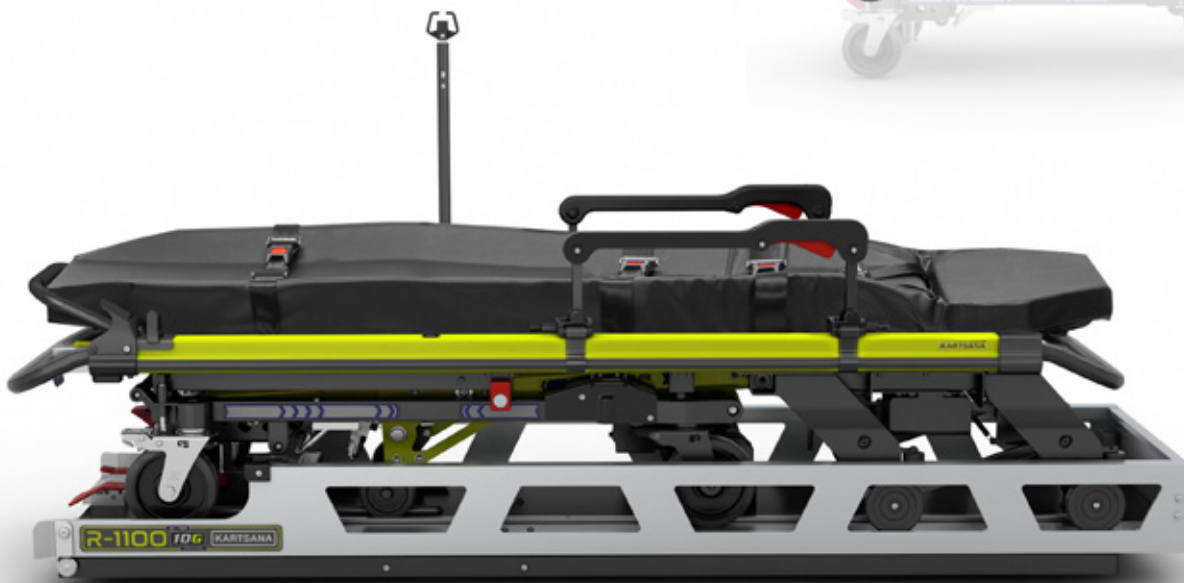

DIMENSIONS AND WEIGHT

R-1100

H	Height (mm)	208
L	Length closed (mm)	1996
L2	Length open (mm)	2090
W	Width (mm)	606
A2	Height rail + stretcher (mm)	510
	Weight (kg)	75,5

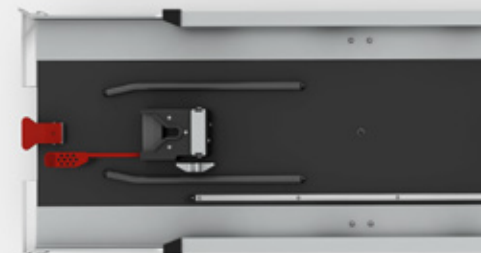
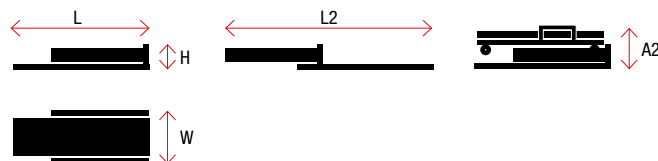

CHEROKEE SERIES

ELECTRIC

03

CHEROKEE SERIES

The electric stretcher for the English-speaking world



Aluminium and stainless steel



Electric



TG-1000UK

- ▷ Adjustable headrest with shock absorber.
- ▷ Double-jointed leg rest with 2 shock absorbers.
- ▷ 4 Ø160 mm rotating wheels (2 lockable wheels + 2 with brakes).
- ▷ Guardrails that collapse longitudinally and fold outwards.
- ▷ Folding IV pole.
- ▷ Three-point safety belt kit.
- ▷ Manual operation system.



Product certification

All KARTSANA products comply with the EN 1865 and 1789 standards.

01

Control panel

New and improved control panel, now more intuitive, autonomous and functional.



02

2 attachment systems

Fixed anchor.



Mobile anchor.



03 Drive handles

A! ACCESSORIES: for CHEROKEE SERIES accessories, see pages 48, 49 and 50.

DIMENSIONS AND WEIGHT

	TG-1000UK
H Max. height (mm)	955
H2 Min. height (mm)	465
HC Max. adjustable height (mm)	940
L Length (mm)	1990
L2 Length closed (mm)	1680
L3 Length open (mm)	1990
W Width (mm)	567
Load capacity (kg)	300
Weight (kg)	78,6

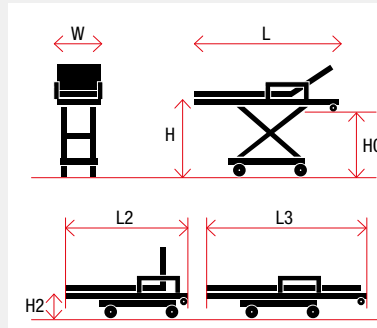

CHEROKEE ATTACHMENT DIMENSIONS AND WEIGHT

	FIXED		MOBILE	
	R-100F	R-101F	R-102	R-103
Height (mm)	327	146	326,6	146
Length (mm)	332	337,5	385	443,5
Width (mm)	190	200	329	329
Weight (kg)	8	8,5	10	10,5



INNOVATION AND DESIGN

Every detail is carefully designed to create products with a solid yet manageable structure.

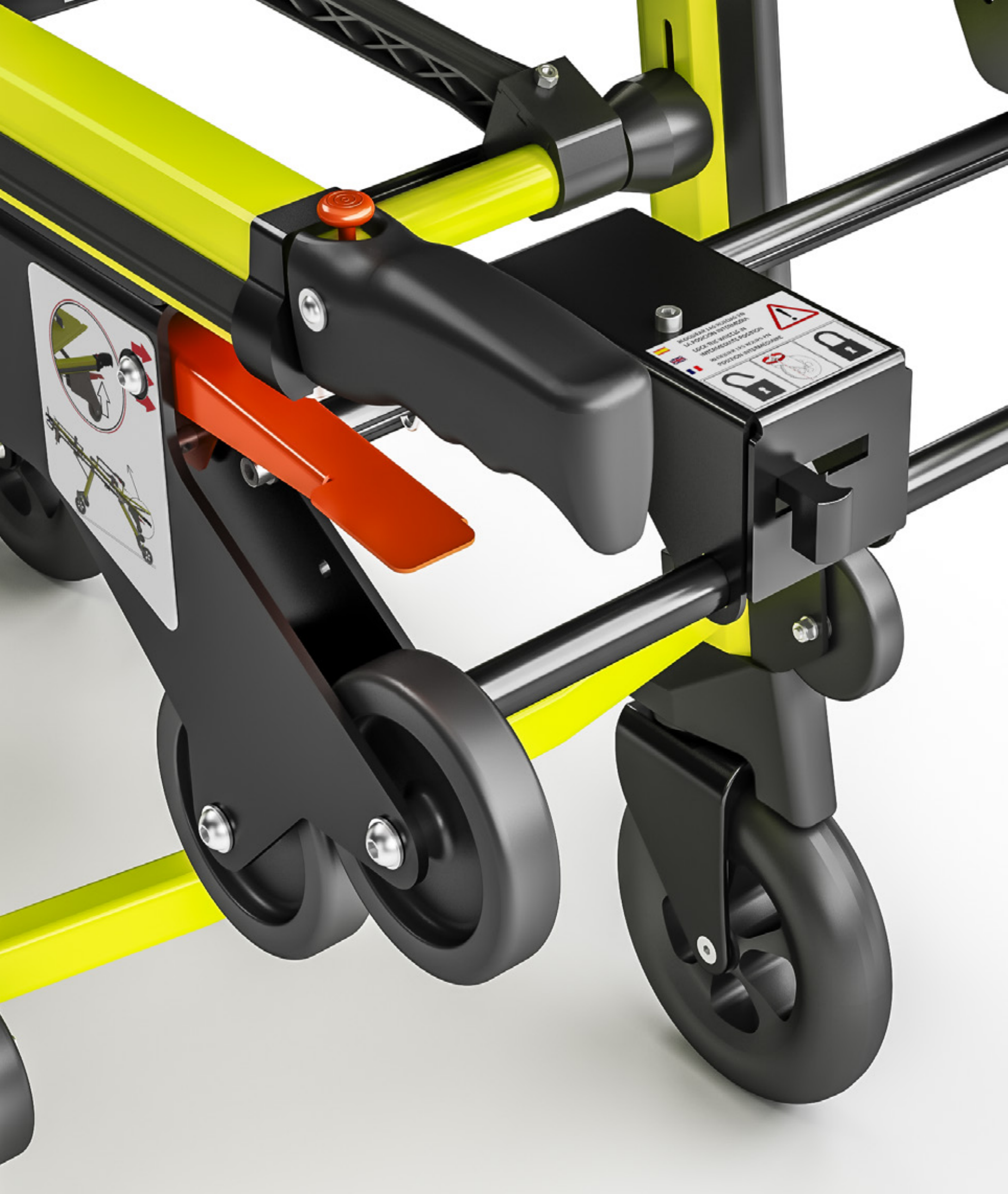



MECHANICAL

MECHANICAL EQUIPMENT

01 · JUPITER COMPACT SERIES	20
02 · JUPITER TROLLEY STRETCHER SERIES	24
03 · 241 COMPACT SERIES	28
04 · RAILS	34
05 · EVACUATION CHAIRS	38

JUPITER

COMPACT SERIES

JUPITER

Maximum capacity, minimal effort

High-capacity mechanical stretchers that are surprisingly light and manoeuvrable.



01

Load capacity of 280 kg

Stretcher which can lift a load of up to 280 kg unassisted.



02

Easy to transfer patients

Laterally and longitudinally collapsible guardrails.

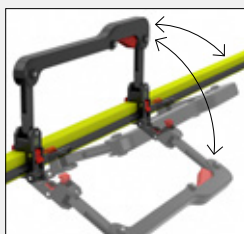

03

Double-jointed leg rest



04

Bariatric kit



Product certification

All KARTSANA products comply with the EN 1865 and 1789 standards.



A! ACCESSORIES: for JUPITER SERIES accessories, see pages 48, 49 and 50.

COMPACT

Comparison of the features of the JUPITER COMPACT SERIES

		TG-880 C2	TG-880 C4	TG-880S C4	TG-880M C4	TG-880C4 IN
Adjustable headrest with shock absorber		✓	✓	✓	✓	
Double-jointed leg rest with 2 shock absorbers		✓	✓	✓	✓	
Positions	5			✓		
	8	✓	✓		✓	✓
Front wheels (200 mm)	Lockable rotating		✓	✓	✓	✓
	Fixed	✓				
Rear wheels (200 mm)	Rotating	✓	✓	✓	✓	✓
Trendelenburg and reverse Trendelenburg		✓	✓	✓	✓	✓
Longitudinally collapsible guardrails		✓	✓	✓	✓	
Laterally collapsible guardrails		✓	✓	✓	✓	
Folding IV pole		✓	✓	✓	✓	
Safety belt kit for shoulders, abdomen and legs		✓	✓	✓	✓	
Aluminium tray for cardiac massage		✓	✓	✓	✓	
4 telescopic handles		✓	✓	✓	✓	✓

Compatibility with rails

Rails	JUPITER COMPACT SERIES
R-419	Only model TG-880SC4
R-419L	All models except TG-880SC4
R-450N	All models except TG-880SC4
R-450S STAINLESS STEEL	Only model TG-880SC4
R-800G	Only model TG-880SC4
R-800L	All models except TG-880SC4

JUPITER COMPACT Paediatric

The JUPITER SERIES features the TG-880 C4 IN stretcher which is specially designed for paediatric services that require an incubator. More information on page 42.



TG-880 C4 / TG-880 C2

- ▷ 8 intermediary position.
- ▷ Trendelenburg and reverse Trendelenburg.
- ▷ Maximum load 280 kg.



Aluminium



Reclinable

2 rotating
wheels4 lockable
wheels

280 kg

CERTIFIED
10G

Paediatric option - TG-880 C4 IN



DIMENSIONS AND WEIGHT

	SIZE L		SIZE M	SIZE S
	TG-880 C2/C4	TG-880 C4 IN	TG-880M C4	TG-880S C4
H Height (mm)	986	986	924	907
HC Height from floor to leading wheel (mm)	720	720	670	601
W Width (mm)	595	595	590	595
L Length (mm)	1974	1974	1990	1975
Weight (kg)	57 / 58,9	55	59,6	55,7

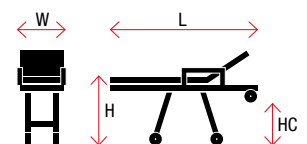



EUROPEAN QUALITY

We guarantee the quality and reliability of our products by creating and manufacturing them in Europe.



JUPITER

TROLLEY STRETCHER

JUPITER

Double the functions, double the comfort

Very easy to assemble, makes transporting patients easier by adapting to different spaces.



A! ACCESSORIES: for JUPITER SERIES accessories, see pages 48, 49 and 50.



01

6 telescopic handles

Also features 2 extra handles on the sides (MTR 120).



02

Integrated control panel

For unfolding the legs.



03

Unfolding

Automatically unfolds the legs while exiting the ambulance.



Comparison of the features of the JUPITER TROLLEY STRETCHER SERIES

TROLLEY	TG 8802	TG 8804
8 positions	✓	✓
Front wheels (200 mm)	Lockable rotating	✓
	Fixed	✓
Rear rotating wheels (200 mm)	✓	✓
Trendelenburg and reverse Trendelenburg	✓	✓
Anti-fold safety system trolley legs	✓	✓
Collapsible rear handles	✓	✓

STRETCHER	MTR-120	MT-118 IN
Adjustable headrest with shock absorber	✓	
Fixed leg rest		
Double-jointed leg rest with 2 shock absorbers	✓	
Longitudinally collapsible guardrails	✓	
Laterally collapsible guardrails	✓	
Folding IV pole	✓	
Aluminium tray for cardiac massage	✓	
Aluminium tray for incubation equipment		✓
4 telescopic handles	✓	✓
Telescopic central handles	✓	
Safety belt kit for abdomen and legs		
Safety belt kit for shoulders, abdomen and legs	✓	



Compatibility with rails

Rails	JUPITER TROLLEY STRETCHER SERIES
R-419L	✓
R-450N	✓
R-800L	✓

Product certification

All KARTSANA products comply with the EN 1865 and 1789 standards.



04

Easy to transfer patients

Laterally and longitudinally collapsible guardrails.

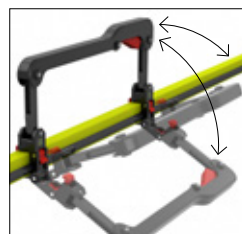

TG-8802

- ▷ 8 intermediary position.
- ▷ Trendelenburg and reverse Trendelenburg.
- ▷ 5 anchoring points to MTR-120 stretchers.



Aluminium



Reclinable



2 rotating wheels



280 kg



TG-8804

- ▷ Same features as TG-8802 except:
4 rotating wheels (200 mm).



Aluminium



Reclinable



4 rotating wheels



280 kg



DIMENSIONS AND WEIGHT

	TG-8802	TG-8804
H Height (mm)	1045	1045
HC Height from floor to leading wheel (mm)	720	720
W Width (mm)	575	575
L Minimum/maximum length (mm)	1990/2369	1990/2369
Weight (kg)	35,9	37,9

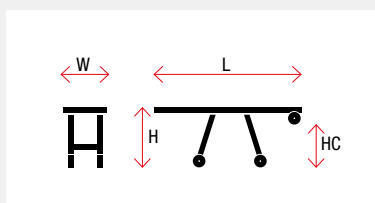

MT-118 IN

- ▷ Versatile, 2-in-1 stretcher.
- ▷ Suitable for all incubator models on the market.



Aluminium



Compatible with incubator

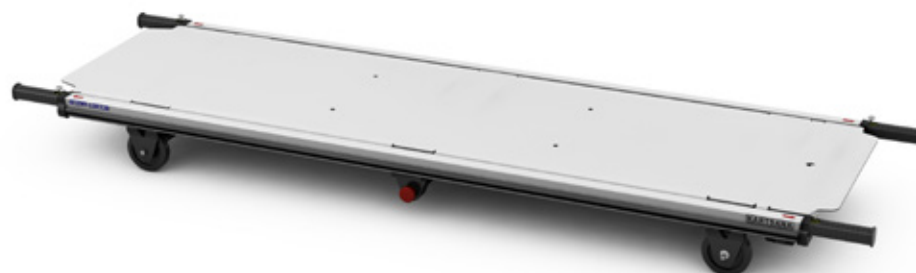

MTR-120

- ▷ Adjustable headrest.
- ▷ Laterally and longitudinally collapsible guardrails.
- ▷ Safety belt kit for shoulders, abdomen and legs.
- ▷ Aluminium tray for performing cardiac massages.
- ▷ Double-jointed leg rest.



Articulated



Guardrails



Aluminium



DIMENSIONS AND WEIGHT

	MT-118 IN	MTR-120
H Height (mm)	150	150
W Width (mm)	590	590
L Minimum/maximum length (mm)	1962	1962
Weight (kg)	32	26,7



241 COMPACT SERIES

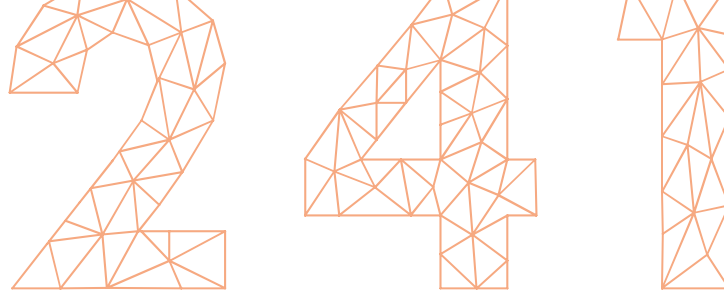

Ability to adapt

A series featuring four models that stand out for their high level of versatility in terms of movement and height.



01

Laterally and longitudinally collapsible guardrails

Easy to transfer patients.

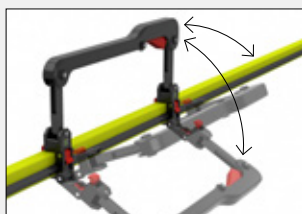

02

Load capacity of 250 kg



03

Double the wheels, double the ease of loading

Two leading wheels (only on the TG model).



04

Safe and easy

Front wheel locking and unlocking (only on the TG model).

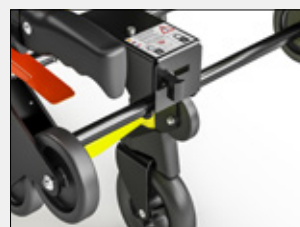

05

Wheel lock



A! ACCESSORIES: for 241 SERIES accessories, see pages 48, 49 and 50.

One series, five models

		TG	TGM	TGX	TGEM	TGEXL
Stretcher mainly made of aluminium		✓	✓	✓	✓	✓
Adjustable headrest with shock absorber		✓	✓	✓	✓	✓
Leg rest	Single-jointed with shock absorber	✓	✓	✓		
	Fixed				✓	✓
Front wheels	Lockable rotating	✓				
	Rotating		✓		✓	
	Fixed			✓		✓
Rear wheels	Lockable rotating	✓	✓	✓	✓	✓
Leading wheel	Twin	✓				
	Single		✓	✓	✓	✓
3 positions		✓	✓	✓	✓	✓
4 telescopic handles		✓	✓	✓	✓	✓
Laterally and longitudinally collapsible guardrails		✓	✓	✓	✓	✓
IV post		✓	✓	✓	✓	✓
Safety belt kit for shoulders, abdomen and legs (3-point)		✓	✓	✓	✓	✓
Aluminium tray for performing cardiac massages		✓	✓	✓	✓	✓
Fire-resistant welded mattress		✓	✓	✓	✓	✓

Trendelenburg and reverse Trendelenburg

Todos los modelos de la Serie 241 disponen de este reclinamiento.



Adaptable to the height of the ambulance rail ramp

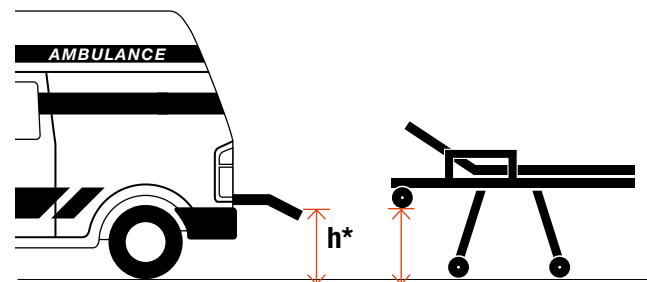

* Recommended loading height, at which the leading wheel makes contact halfway along the rail ramp.

4 available heights



Distance from the floor to the leading wheel to adapt to the rail ramp on the ambulance.

Product certification

All KARTSANA products comply with the EN 1865 and 1789 standards.



Compatibility with rails

Rails	241 COMPACT SERIES
R-419	✓
R-450S STAINLESS STEEL	✓
R-800G	✓

TG-241

DIMENSIONS AND WEIGHT

	S	M	L	XL
H Height (mm)	810	860	904	
HC Height from floor to leading wheel (mm)	530	585	639	-
W Width (mm)	590	590	590	-
L Length (mm)	1951	1951	1951	-
Weight (kg)	44	45,7	48	-



Aluminium



Reclinable



250 kg



Laterally and longitudinally collapsible guardrails



Leg rest with shock absorber



Rotating wheels



Lockable wheels



Twin wheels on leading edge



CERTIFIED 10G

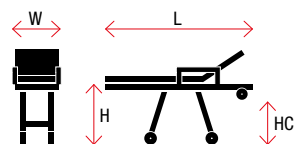

TGX-241

DIMENSIONS AND WEIGHT

	S	M	L	XL
H Height (mm)	-	860	909	953
HC Height from floor to leading wheel (mm)	-	590	642	686
W Width (mm)	-	590	590	590
L Length (mm)	-	1953	1953	1953
L2 Length folded (mm)	-	1630	1630	1571
Weight (kg)	-	45,6	47,6	49,4



Aluminium



Reclinable



250 kg

Longitudinally
collapsible guardrailsLeg rest with
shock absorber

Foldable

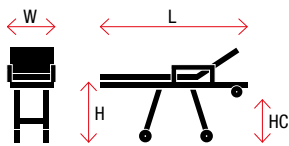
CERTIFIED
10G

TGM-241

DIMENSIONS AND WEIGHT

	S	M	L	XL
H Height (mm)	800	850	910	950
HC Height from the floor to the leading wheel (mm)	570	595	650	705
W Width (mm)	595	595	590	590
L Length (mm)	1951	1951	1951	1951
Weight (kg)	47	47,5	46,7	47,2



Aluminium



Reclinable



250 kg



Laterally and longitudinally collapsible guardrails.



Rotating wheels

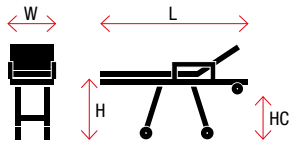

Leg rest with shock absorber

CERTIFIED
10G

TGE-241

DIMENSIONS AND WEIGHT

	S	M	L	XL
H Height (mm)	-	860	-	950
HC Height from the floor to the leading wheel (mm)	-	585	-	700
W Width (mm)	-	590	-	590
L Length (mm)	-	1951	-	1951
Weight (kg)	-	46,5	-	44,1



Aluminium



Reclinable



250 kg



Laterally and longitudinally collapsible guardrails.

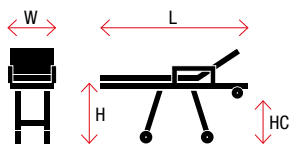

Rotating wheels (TGE-241M)

CERTIFIED
10G

TGE-241M



ABILITY TO ADAPT

We operate in more than 25 countries and adapt to each one's individual needs and regulations.

RAILS

RAIL

The key part that keeps everything working smoothly



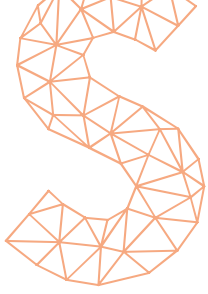

Technical data comparison

	Weight (kg)	Height (mm)	Length open (mm)	Length closed (mm)	Width (mm)	Ramp	10G certified	Suitable for
R-419	46	195	2300	1902	623	✓	✓	Backboard
R-419L	51.5	195	2465	2078	623	✓	✓	Backboard
R-450N	8.5	76	1860	-	380	-	✓	
R-450S STAINLESS STEEL	11.6	75	1708	-	497	-	✓	
R-800G	28	112	2237	1854	626	✓	✓	
R-800L	42	130	2400	2095	620	✓	✓	



Compatible stretchers

	241 SERIES	JUPITER TROLLEY STRETCHER SERIES	JUPITER COMPACT SERIES
R-419	✓		Only model TG-880SC4
R-419L		✓	All models except TG-880SC4
R-450N		✓	All models except TG-880SC4
R-450S STAINLESS STEEL	✓		Only model TG-880SC4
R-800G	✓		Only model TG-880SC4
R-800L		✓	All models except TG-880SC4

Product certification

All KARTSANA products comply with the EN 1865 and 1789 standards.



R-419 / R-419L

- ▷ It can store a backboard or scoop stretcher.
- ▷ Manual locking/unlocking of the entry ramp.



Aluminium and steel



Ramp



Backboard stretcher drawer

CERTIFIED
10G

DIMENSIONS AND WEIGHT

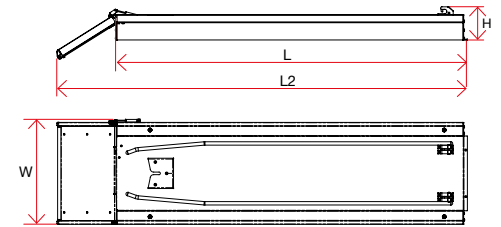

	R-419	R-419L
H Height (mm)	195	195
L Length closed (mm)	1902	2078
L2 Length open (mm)	2300	2465
W Width (mm)	623	623
Weight (kg)	46	51,5



Compatible stretchers

	241 SERIES	JUPITER SERIES	JUPITER COMPACT SERIES
R-419	✓		Only model TG-880SC4
R-419L		✓	All models except TG-880SC4

R-800G / R-800L

- ▷ Manual locking/unlocking of the entry ramp.



Aluminium and steel



Ramp

CERTIFIED
10G

DIMENSIONS AND WEIGHT

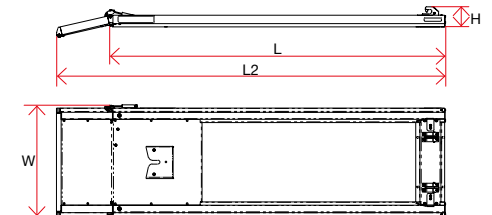

	R-800G	R-800L
H Height (mm)	112	130
L Length closed (mm)	1854	2095
L2 Length open (mm)	2237	2400
W Width (mm)	626	620
Weight (kg)	28	42



Compatible stretchers

	241 SERIES	JUPITER COMPACT SERIES
R-800G	✓	Only model TG-880SC4
R-800L		All models except TG-880SC4

R-450N

- ▷ Rail made from steel with an epoxy paint finish.
- ▷ Can be installed on the floor or on a platform (recommended).

CERTIFIED
10G



DIMENSIONS AND WEIGHT

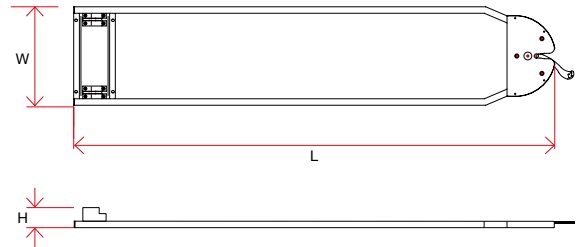

Compatible stretchers

	JUPITER SERIES	JUPITER COMPACT SERIES
R-450N	✓	All models except for TG-880S C4

R-450N

H Height (mm)	76
L Length (mm)	1860
W Width (mm)	380
Weight (kg)	8.5

R-450S INOX

- ▷ Rail made from polished stainless steel.
- ▷ Can be installed on the floor or on a platform (recommended).

SS
Stainless
steel

CERTIFIED
10G

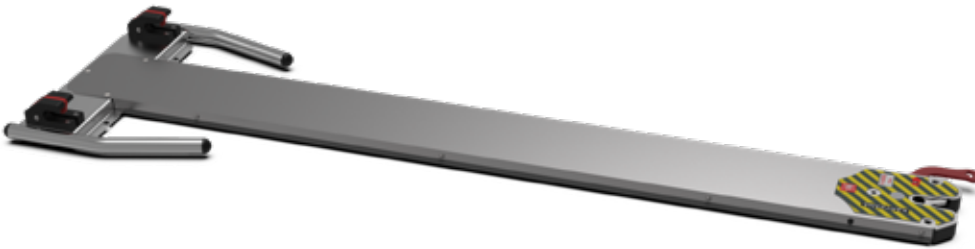

DIMENSIONS AND WEIGHT

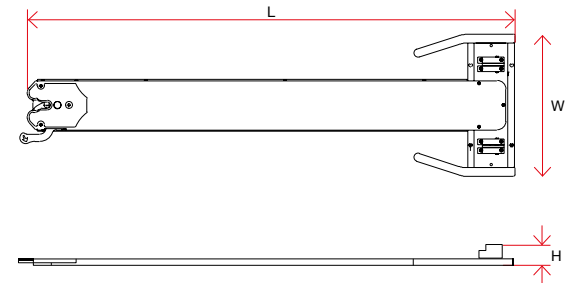

Compatible stretchers

	241 SERIES	JUPITER COMPACT SERIES
R-450S STAINLESS STEEL	✓	Only TG-880SC4

R-450S STAINLESS STEEL

H Height (mm)	75
L Length (mm)	1708
W Width (mm)	497
Weight (kg)	11.6

EVACUATION CHAIRS

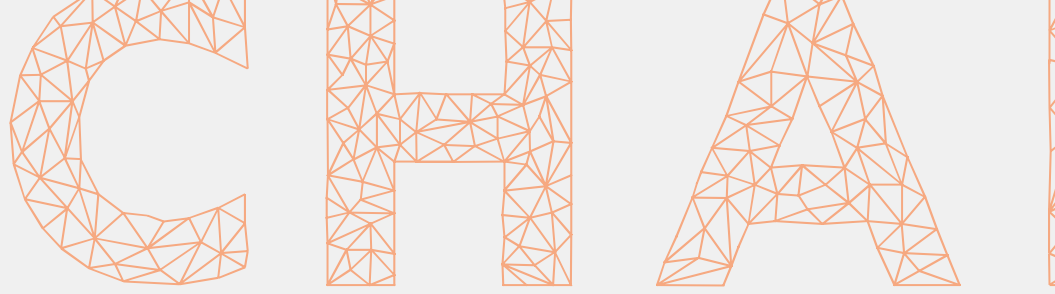

For all needs

Light and safe chairs for transporting and evacuating patients whatever the situation.





S-127



- ▷ Aluminium folding chair with an epoxy paint finish.
- ▷ 2 safety belts.
- ▷ 2 wheels.

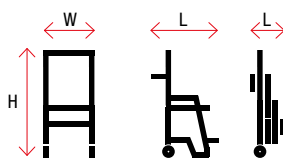

DIMENSIONS AND WEIGHT

		S-127	S-129	S-129RG
UNFOLDED CHAIR	L Length (mm)	498	720	760
	W Width (mm)	489	500	525
	H Height (mm)	1035	921	990
FOLDED CHAIR	L Length (mm)	498	247	247
	W Width (mm)	196	500	525
	H Height (mm)	596	921	990
Weight (kg)		8.0	8.6	10.9
Load capacity (kg)		150	150	150

S-129



- ▷ Aluminium folding chair with an epoxy paint finish.
- ▷ 4 wheels.
- ▷ 6 handles (4 collapsible + 2 extendable).
- ▷ Folding footrest.
- ▷ 3 safety belts.
- ▷ Weight: 8,600 kg.

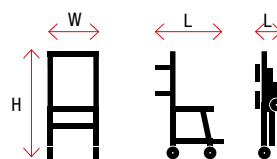

S-129 RG



- ▷ Aluminium folding chair.
- ▷ 4 wheels.
- ▷ 6 handles (4 collapsible + 2 extendable).
- ▷ 3 safety belts.
- ▷ Folding footrest.
- ▷ Weight: 10,900 kg.

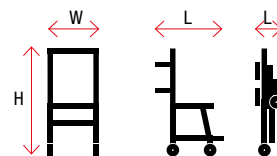



SPECIAL EQUIPMENT

01 · INCUBATOR STRETCHERS	42
02 · REMOVAL STRETCHERS	46
03 · ACCESSORIES	48



INCUBATOR STRETCHERS

INCUBATOR

Safety and care while transporting the most delicate

The widest range for paediatrics offers smooth movement and high levels of autonomy.



TG-1000 IN

- ▷ Stretcher compatible with incubators for paediatric services.
- ▷ Adjustable working height.
- ▷ 4 ø160 mm rotating wheels (2 locking wheels + 2 with brakes).
- ▷ Hydraulic system unlocking button in case of fault.
- ▷ Safety system for avoiding collapse.



Aluminium



Electric



300 kg unassisted



CERTIFIED 10G



DIMENSIONS AND WEIGHT

		TG-1000-IN
H	Max. height (mm)	1300
H2	Min. height (mm)	350
L	Length (mm)	1972
W	Width (mm)	574
Weight (kg)		61

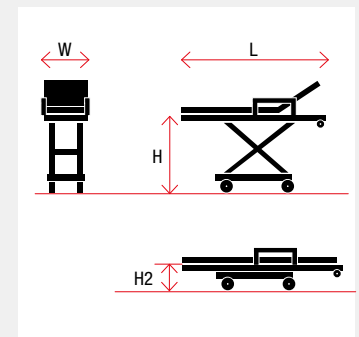

* Upper C-004 tray not included in reference TG-1000 IN.

01 300 kg unassisted

Stretcher with a hydraulic elevation system which can lift loads of up to 300 kg unassisted.



02 Complete compatibility



03 Unlocking pedal

Wheels are unlocked using a single pedal to give the operator maximum control.



04 Control panel

New and improved control panel, now more intuitive, autonomous and functional.



05 Emergency lights

For increased safety.



06 Maximum autonomy

Features 2 batteries to guaranteed operation.



A! ACCESSORIES: for BRAVA SERIES accessories, see pages 48, 49 and 50.

TG-880 C4 IN



Aluminium



4 lockable wheels



280 kg



CERTIFIED
10G

DIMENSIONS AND WEIGHT

TG-880 C4 IN

H Height (mm)	986
HC Height from floor to leading wheel (mm)	720
W Width (mm)	595
L Length (mm)	1974
Weight (kg)	55

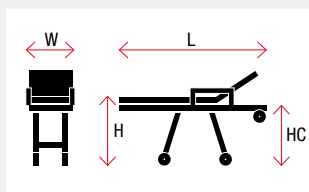

Compatibility with rails

Rails	TG-880 C4 IN
R-419L	✓
R-800L	✓
R-450N	✓

MT-118 IN

- ▷ Compatible with the JUPITER Trolley Stretcher Series.
- ▷ Can be adapted to all models of incubators.
- ▷ 4 telescopic handles + 2 side handles.



Aluminium



CERTIFIED
10G



DIMENSIONS AND WEIGHT

MT-118 IN

H Height (mm)	150
W Width (mm)	590
L Length (mm)	1962
Weight (kg)	32





PRACTICALITY

Solutions that make work easier for professionals without compromising the patient's well-being.

MORTUARY STRETCHERS

REMOVAL

For functional and discreet removal

TGF-241S / TGF-241S4

- ▷ Made of Aluminum. Light and handy.
- ▷ 1 intermediate position to facilitate the transfer from the bed to the stretcher.
- ▷ **TGF-241S**: 2 lockable rear wheels and 2 fixed front wheels.
- ▷ **TGF-241S4**: 4 rotating lockable wheels.
- ▷ 4 telescopic handles for easy maneuverability.
- ▷ Three-point safety belt kit to properly secure the body.



DIMENSIONS AND WEIGHT

	TGF-241S	TGF-241S4
H Height (mm)	810	810
HC Height from the floor to the leading wheel (mm)	550	550
W Width (mm)	570	570
L Length (mm)	1975	1975
Stretcher weight (Kg)	36	36
Total weight (Kg)	47	47

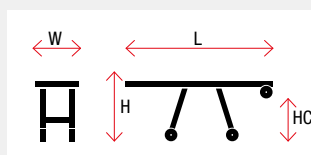

	C-023
H Height (mm)	286
W Width (mm)	470.5
L Length (mm)	1965
Weight (Kg)	11

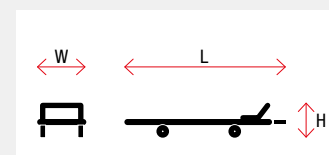

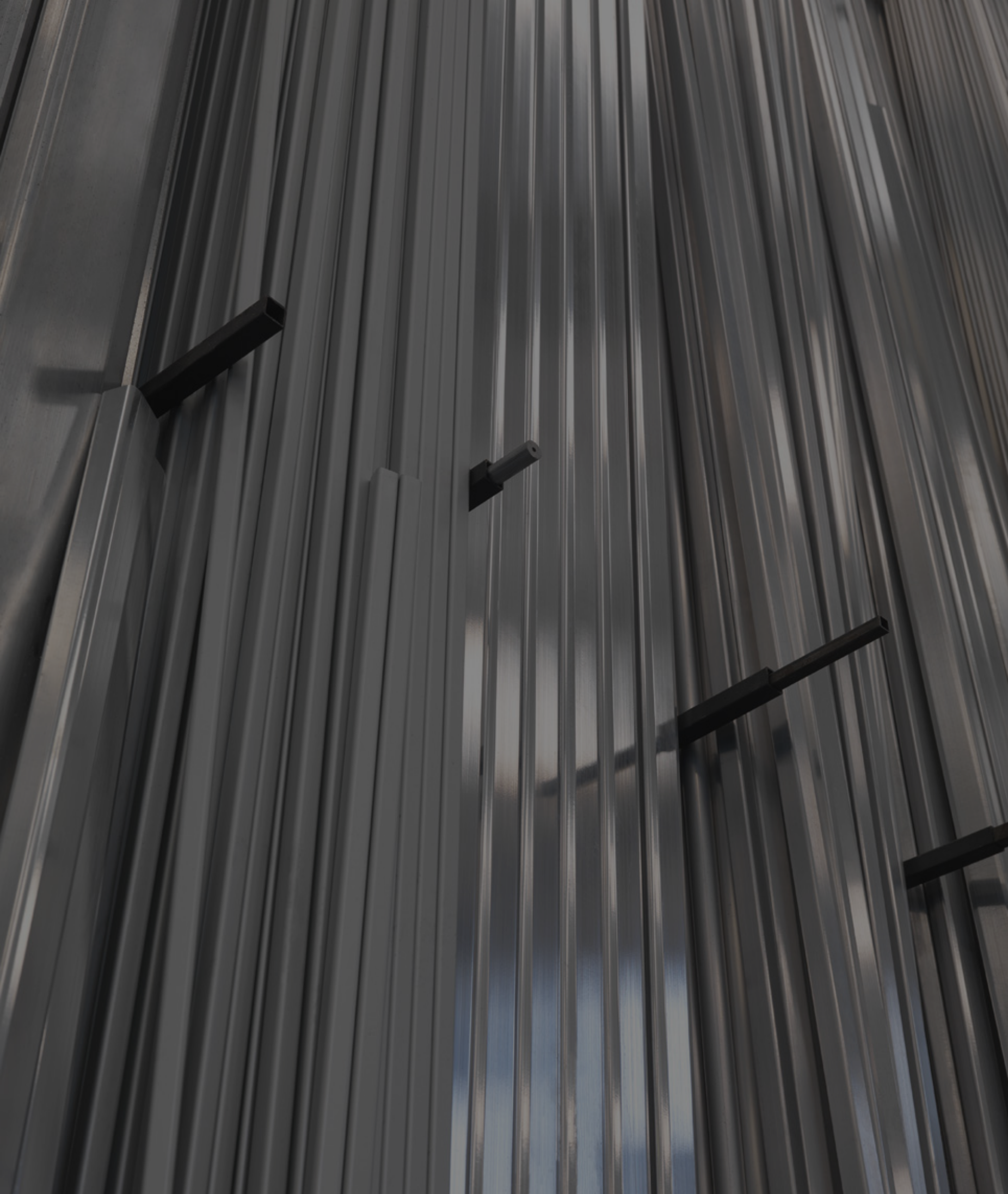

ACCESSORIES

An essential complement to any emergency equipment



CLICK Bariatric Kit

Accessory for quickly widening the stretcher to transport larger patients. The system is rapidly installed in just 8 seconds. It is supplied with safety belts, side cushions and a comfortable bag for transporting it.



Ref	Description	Compatibility
C-064	CLICK bariatric kit	BRAVA SERIES
C-079	CLICK bariatric kit	JUPITER SERIES
C-085	Assembly set for bariatric kit	BRAVA SERIES
C-084	Assembly set for bariatric kit	JUPITER SERIES

Bariatric Kit

Accessory for expanding the surface of the stretcher to transport larger patients. The foldable system is fitted in just 6 minutes and comes with safety belts, side cushions and a comfortable bag for transporting it.

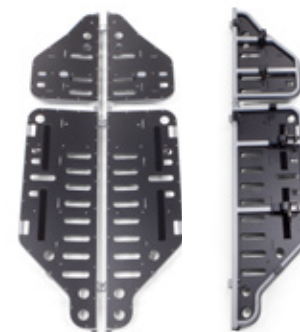

Ref	Description	Compatibility
C-010	Bariatric kit	BRAVA SERIES
C-011	Bariatric kit	JUPITER SERIES

Mattresses for bariatric kit

Spare side cushions for the bariatric kit widening attachment.

Ref	Compatibility
C-008	C-010 and C-011
C-009	C-010 and C-011



Instrument table

A range of instrument tables adapted to the different series of KARTSANA stretchers. It features several different installation options for different medical apparatus.

Ref	Description	Compatibility
M-138	Standard instrument table	241 and JUPITER SERIES
M-139	Standard instrument table	BRAVA SERIES
M-140	Telescopic instrument table	241 and JUPITER SERIES



Support for CORPULS

Suitable accessory for fastening the CORPULS monitoring unit to the side of the stretcher.

Ref	Compatibility
C-040	BRAVA SERIES



TG-1000 belts

Belt extension set for the TG-1000 POWER BRAVA stretcher.

Ref	Compatibility
C-035	BRAVA SERIES



Collapsible headrest extension

Collapsible headrest extension kit which allows the wing cushion to be folded or unfolded. The wing cushion is acquired separately. See Ref. C-007.

Ref	Compatibility
C-014	BRAVA, SILVER and CHEROKEE



Fixed headrest extension

Fixed headrest extension kit. Purchase together with: C-007.

Ref	Compatibility
C-006	BRAVA AND SILVER SERIES



External battery charger

Allows all KARTSANA electric stretcher batteries to be charged using a conventional 230V wall socket.

Ref	Compatibility
07-0032	BRAVA, SILVER and CHEROKEE



Discharged battery activator

Accessory for recovering discharged batteries via a conventional 230V power supply.

Ref	Compatibility
07-0056	BRAVA, SILVER and CHEROKEE



TG-1000 IN BRAVA Series Tray

Upper stretcher tray for incubator. TG-1000 IN BRAVA Series.

Ref	Compatibility
C-004	TG-1000 IN BRAVA SERIES



BRAVA Series Mattress

Anatomic mattress adaptable for TG-1000 POWER BRAVA.

Ref	Compatibility
P-370	TG-1000 BRAVA SERIES



Oxygen bottle holder

Discreet support for holding oxygen bottles.

Ref	Compatibility
C-003	All series



IV pole

Telescopic support for IV drips. Two IV poles can be installed on KARTSANA stretchers at a time.

Ref	Compatibility
52-0610	All series



Wing cushion

Anatomical cushion to install directly on the mattress or on KARTSANA accessories. Made from heat-resistant material with welded seams.

Ref	Compatibility
C-007	All cushions



Evacuation chair support

Support for the S-129 chair. Accessory to be installed on the ambulance doors to hold the rescue chair.

Ref	Compatibility
C-013	S-129



Accessories bag Series 241

Bag for storage of accessories and personal items. Can be fastened to the backrest of Series 241 stretchers.

Ref	Compatibility
C-080	241 SERIES



Accessories bag BRAVA Series

Bag for storage of accessories and personal items. Can be fastened to the backrest of the TG-1000 stretcher.

Ref	Compatibility
C-081	BRAVA SERIES



TGF-241S Tray

Pull-out tray with wheels for body collection vans.

Ref	Compatibility
C-023	TGF-241S and TGF-241S4



Mattress Series 241

Anatomical mattress adaptable to all 241 Series.

Ref	Compatibility
P-359	All SERIES 241 mattresses.





RENEWED EXPERIENCE

Committed to our clients,
we strive to improve day in and day out.

KARTSANA designs, manufactures and distributes land and air emergency healthcare transport equipment.

Thanks to the experience the company has accumulated over its more than 37 years of history, KARTSANA's stretchers and chairs offer practical, reliable and safe solutions based on an optimal structural design and constant technical evolution. Equipment which makes it easier for emergency healthcare professionals to do their job while maintaining the comfort and safety of patients.

KARTSANA currently operates in more than 28 countries, fully adapting to the particular circumstances and regulations of each market.



KARTSANA S.L.

Narcís Monturiol, 34
08192 · Sant Quirze del Vallès
Barcelona (Spain)
T.: +34 93 715 86 72
E.: info@kartsana.com
www.kartsana.com

03-2023

© 2023 · Kartsana. All rights reserved.

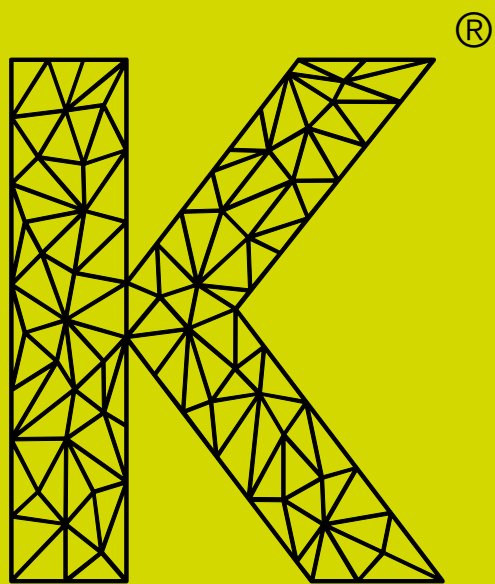



www.kartsana.com

