

# Smart fire suppression



FirePro UK are active members of



[sales@fireprouk.com](mailto:sales@fireprouk.com)

[www.fireprouk.com](http://www.fireprouk.com)

Accredited for ISO 9001 by BSI



# Smart fire suppression

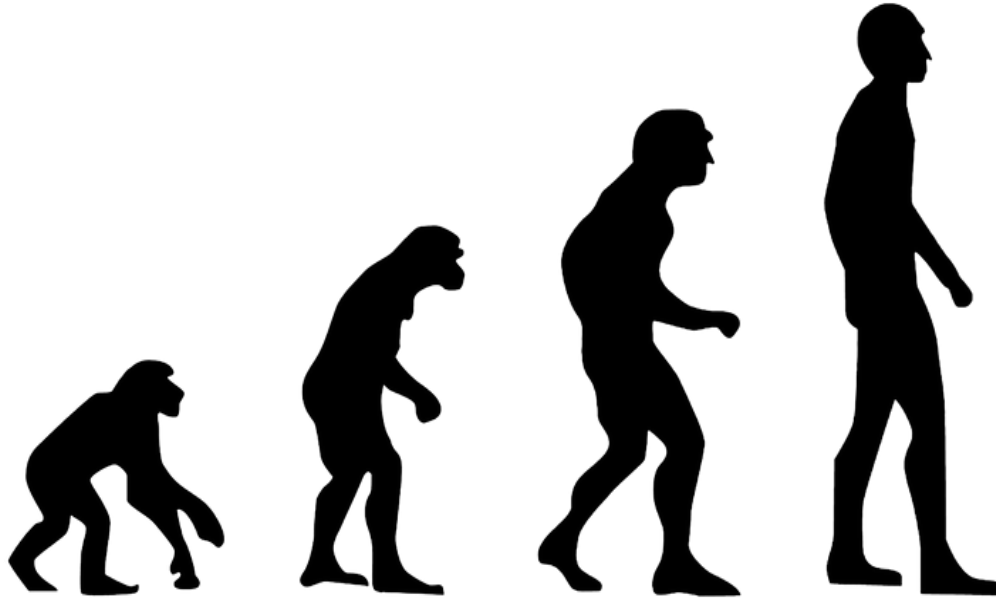

FirePro UK are active members of



[sales@fireprouk.com](mailto:sales@fireprouk.com)

[www.fireprouk.com](http://www.fireprouk.com)

Accredited for ISO 9001 by BSI



# Smart fire suppression



**FM 200**



**Co2**



**Novac**

Accredited for ISO 9001 by BSI

FirePro UK are active members of



[sales@fireprouk.com](mailto:sales@fireprouk.com)

[www.fireprouk.com](http://www.fireprouk.com)



# Smart fire suppression

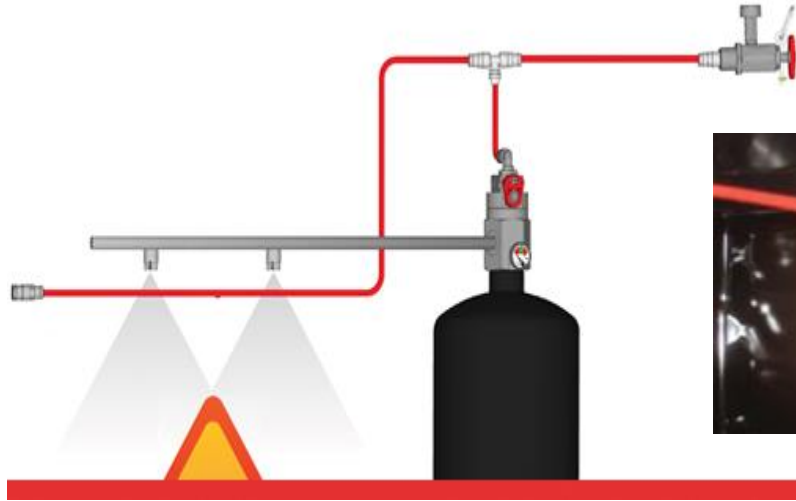

FM 200

Image © Jactone

FirePro UK are active members of



[sales@fireprouk.com](mailto:sales@fireprouk.com)

[www.fireprouk.com](http://www.fireprouk.com)

Accredited for ISO 9001 by BSI



# Smart fire suppression

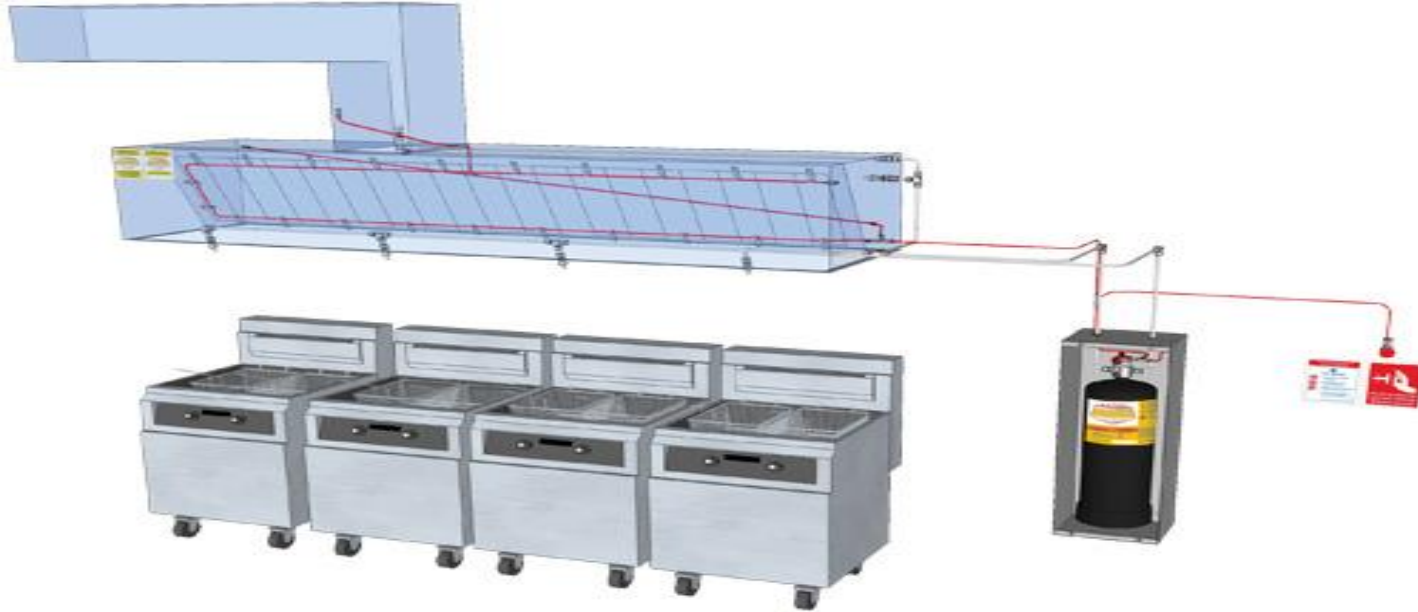

Image © Jactone

FirePro UK are active members of



[sales@fireprouk.com](mailto:sales@fireprouk.com)

[www.fireprouk.com](http://www.fireprouk.com)

Accredited for ISO 9001 by BSI



# Smart fire suppression



FirePro UK are active members of



[sales@fireprouk.com](mailto:sales@fireprouk.com)

[www.fireprouk.com](http://www.fireprouk.com)

Accredited for ISO 9001 by BSI



# Smart fire suppression



- Condensed aerosol (CA) is not new.
- Used by USSR during the space race.
- FirePro systems formed 96 in Cyprus
- Now sold in 86 countries
- 2 or 3 alternate products on the market
- Distinct advantages create new possibilities
- Manufactured in Limassol, Cyprus.
- Trinity Fire & Security have extensive experience with various installations
- LPCB certified product.

FirePro UK are active members of



[sales@fireprouk.com](mailto:sales@fireprouk.com)

[www.fireprouk.com](http://www.fireprouk.com)

Accredited for ISO 9001 by BSI



# Smart fire suppression

- FirePro is the suppression agent
- It may be engineered in most room flood or local applications
- It can be engineered with virtually any form of appropriate detection
- For local application, there is a myriad of ways to engineer it
- For room flood, the FirePro panel must be used – no other
- This flexibility gives competitive advantage over others
- Alternate solution where water or gas is uneconomical or wont work

FirePro UK are active members of



[sales@fireprouk.com](mailto:sales@fireprouk.com)

[www.fireprouk.com](http://www.fireprouk.com)

Accredited for ISO 9001 by BSI





# Intelligent fire suppression

Terminology Lesson

These canisters are termed “generators”

Lets cut one open

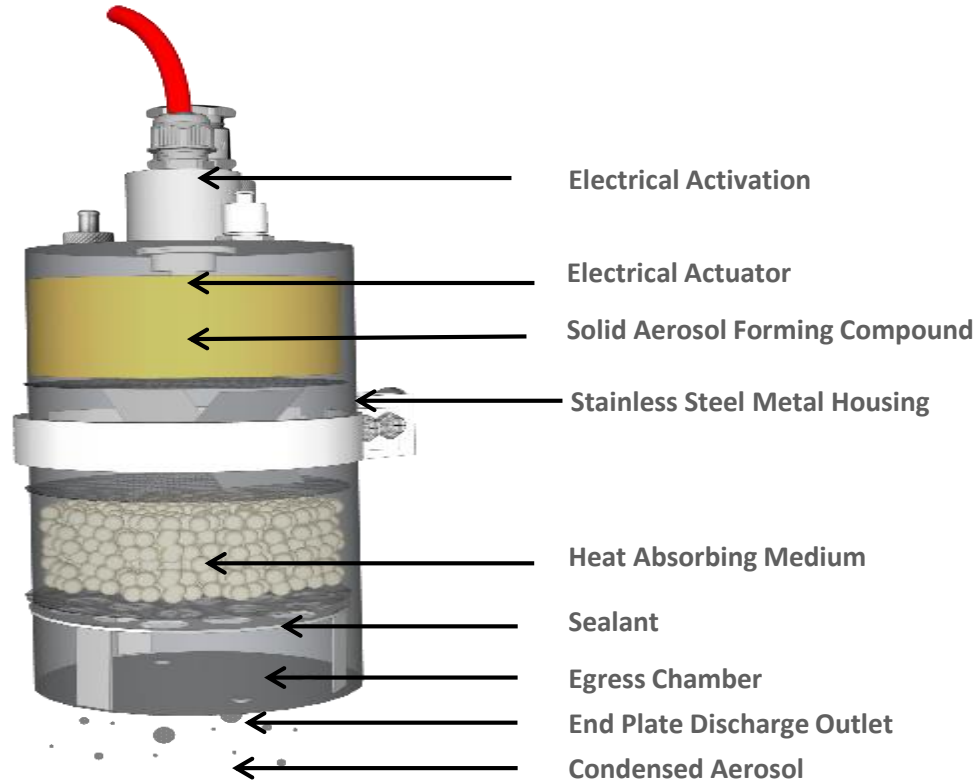

# Intelligent fire suppression

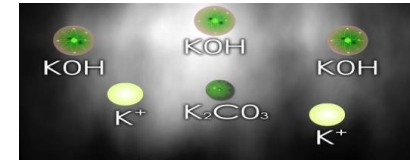
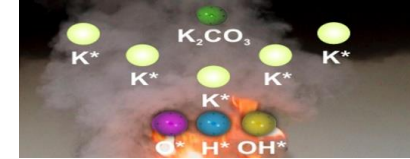
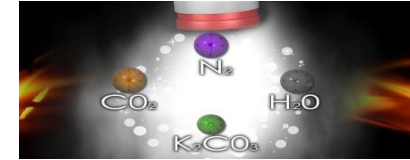
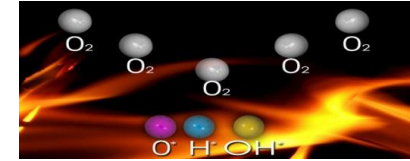
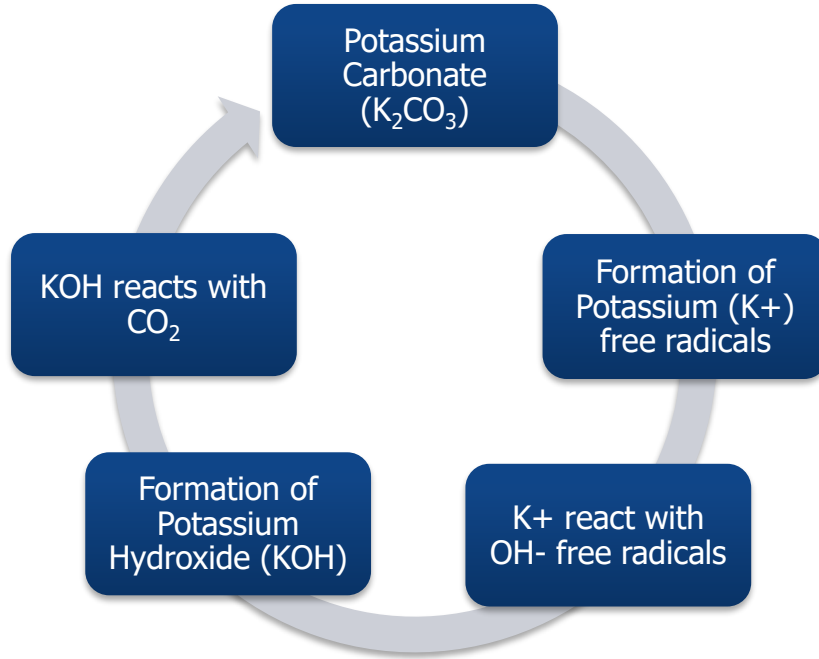

# Smart fire suppression

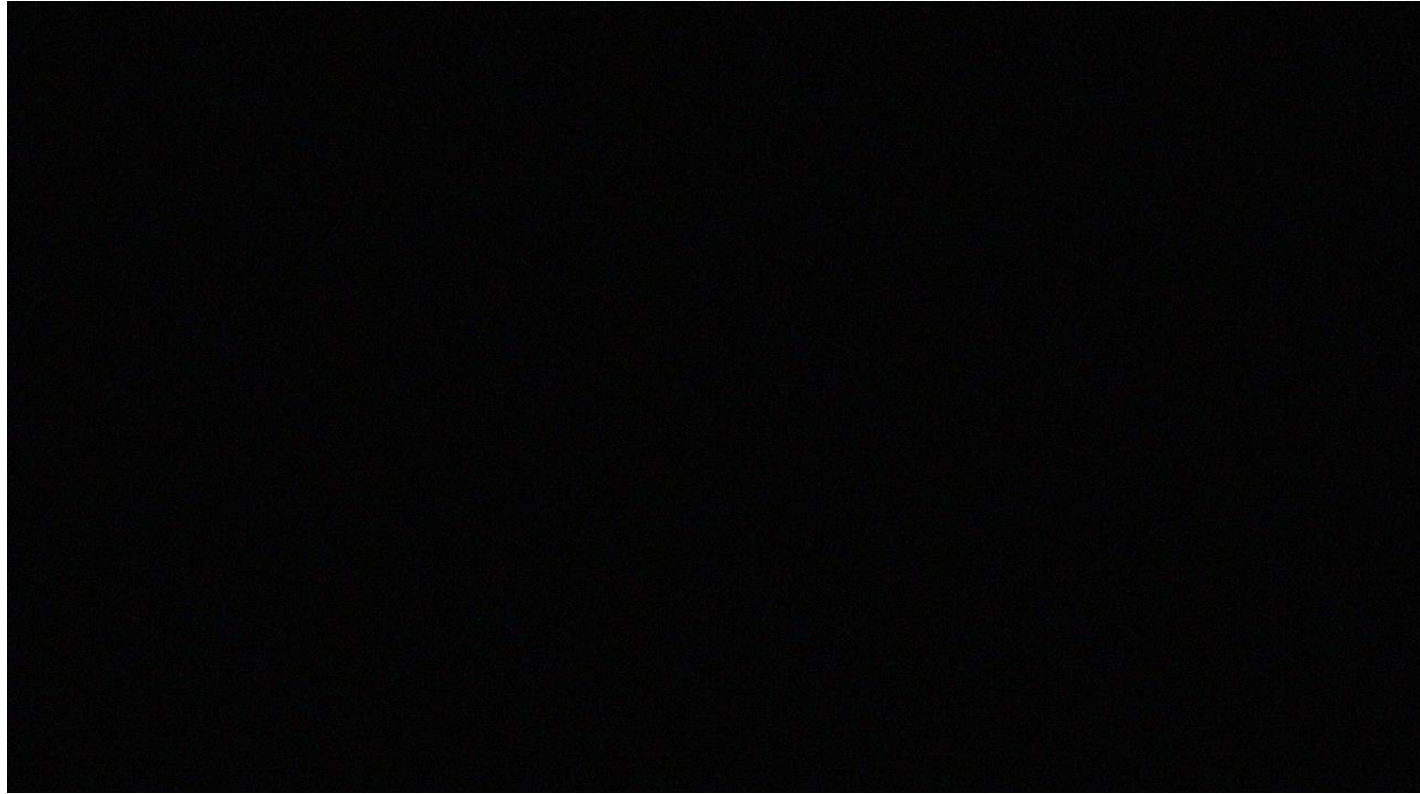

FirePro UK are active members of



[sales@fireprouk.com](mailto:sales@fireprouk.com)

[www.fireprouk.com](http://www.fireprouk.com)

Accredited for ISO 9001 by BSI



# Smart fire suppression

- Its all electrical – no cylinders or pipe. Modularity creates possibilities.
- Installation / cost of ownership is comparably lower than gas or water.
- Independently certified 15 year lifetime with minimal maintenance.
- Low pressure discharge - No over pressure relief venting.
- Greater tolerance to areas of poor enclosure integrity.
- Engineering flexibility for bespoke application and use, incl re-use.
- Green environmental credentials EPA certified safe in occupied spaces.
- Projects include various NHS Trusts, UKPN, BA, Honda F1, Ford, McLaren, O2, Virgin Media, LC Airport, Universities, & more.
- Global case study bank.

FirePro UK are active members of



[sales@fireprouk.com](mailto:sales@fireprouk.com)

[www.fireprouk.com](http://www.fireprouk.com)

Accredited for ISO 9001 by BSI



# Smart fire suppression



FirePro UK are active members of



[sales@fireprouk.com](mailto:sales@fireprouk.com)

[www.fireprouk.com](http://www.fireprouk.com)

Accredited for ISO 9001 by BSI



# Smart fire suppression

**FirePro.**  
www.fireprouk.com



FirePro UK are active members of



[sales@fireprouk.com](mailto:sales@fireprouk.com)

[www.fireprouk.com](http://www.fireprouk.com)

Accredited for ISO 9001 by BSI



# Smart fire suppression

**FirePro.**  
www.fireprouk.com



FirePro UK are active members of



[sales@fireprouk.com](mailto:sales@fireprouk.com)

[www.fireprouk.com](http://www.fireprouk.com)

Accredited for ISO 9001 by BSI



# Smart fire suppression

**FirePro.**  
www.fireprouk.com



FirePro UK are active members of



[sales@fireprouk.com](mailto:sales@fireprouk.com)

[www.fireprouk.com](http://www.fireprouk.com)

Accredited for ISO 9001 by BSI





# Smart fire suppression

**FirePro.**  
www.fireprouk.com



FirePro UK are active members of



[sales@fireprouk.com](mailto:sales@fireprouk.com)

[www.fireprouk.com](http://www.fireprouk.com)

Accredited for ISO 9001 by BSI



# Smart fire suppression

**FirePro.**  
www.fireprouk.com



FirePro UK are active members of



[sales@fireprouk.com](mailto:sales@fireprouk.com)

[www.fireprouk.com](http://www.fireprouk.com)

Accredited for ISO 9001 by BSI



# Smart fire suppression



FirePro UK are active members of



[sales@fireprouk.com](mailto:sales@fireprouk.com)

[www.fireprouk.com](http://www.fireprouk.com)

Accredited for ISO 9001 by BSI



# Smart fire suppression



FirePro UK are active members of



[sales@fireprouk.com](mailto:sales@fireprouk.com)

[www.fireprouk.com](http://www.fireprouk.com)

Accredited for ISO 9001 by BSI



# Smart fire suppression

**FirePro.**  
www.fireprouk.com



FirePro UK are active members of



[sales@fireprouk.com](mailto:sales@fireprouk.com)

[www.fireprouk.com](http://www.fireprouk.com)

Accredited for ISO 9001 by BSI



# Smart fire suppression



FirePro UK are active members of



[sales@fireprouk.com](mailto:sales@fireprouk.com)

[www.fireprouk.com](http://www.fireprouk.com)

Accredited for ISO 9001 by BSI



# Smart fire suppression

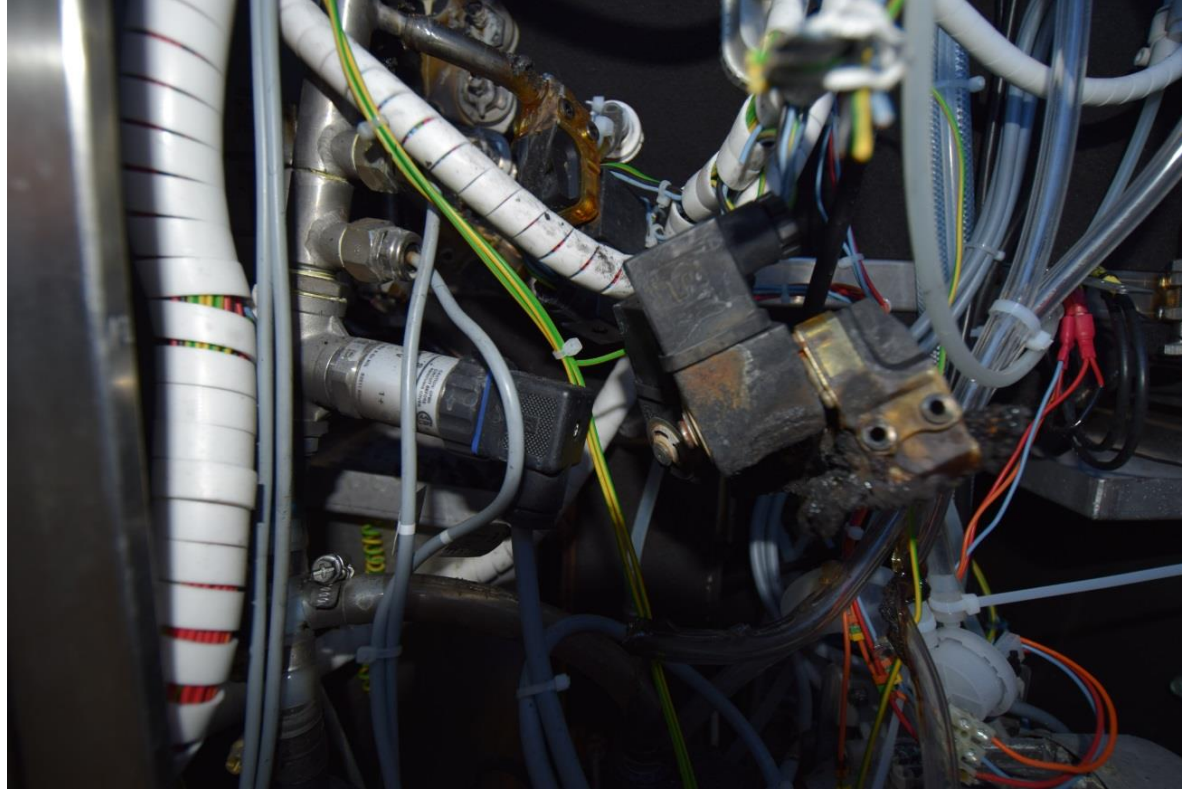

FirePro UK are active members of



[sales@fireprouk.com](mailto:sales@fireprouk.com)

[www.fireprouk.com](http://www.fireprouk.com)

Accredited for ISO 9001 by BSI



# Smart fire suppression



FirePro UK are active members of



[sales@fireprouk.com](mailto:sales@fireprouk.com)

[www.fireprouk.com](http://www.fireprouk.com)

Accredited for ISO 9001 by BSI





# Smart fire suppression



FirePro UK are active members of



[sales@fireprouk.com](mailto:sales@fireprouk.com)

[www.fireprouk.com](http://www.fireprouk.com)

Accredited for ISO 9001 by BSI



# Smart fire suppression



FirePro UK are active members of



[sales@fireprouk.com](mailto:sales@fireprouk.com)

[www.fireprouk.com](http://www.fireprouk.com)

Accredited for ISO 9001 by BSI



# Smart fire suppression

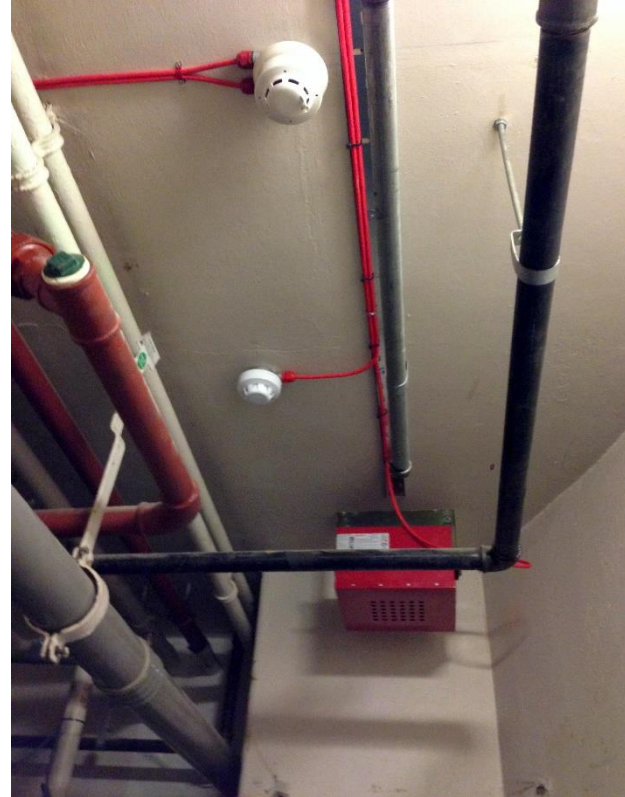

FirePro UK are active members of



[sales@fireprouk.com](mailto:sales@fireprouk.com)

[www.fireprouk.com](http://www.fireprouk.com)

Accredited for ISO 9001 by BSI



# Smart fire suppression



FirePro UK are active members of



[sales@fireprouk.com](mailto:sales@fireprouk.com)

[www.fireprouk.com](http://www.fireprouk.com)

Accredited for ISO 9001 by BSI



# The role of intelligent fire suppression



# Smart fire suppression



FirePro UK are active members of



[sales@fireprouk.com](mailto:sales@fireprouk.com)

[www.fireprouk.com](http://www.fireprouk.com)

Accredited for ISO 9001 by BSI



# Smart fire suppression

**FirePro.**  
www.fireprouk.com



FirePro UK are active members of



[sales@fireprouk.com](mailto:sales@fireprouk.com)

[www.fireprouk.com](http://www.fireprouk.com)

Accredited for ISO 9001 by BSI



# Smart fire suppression

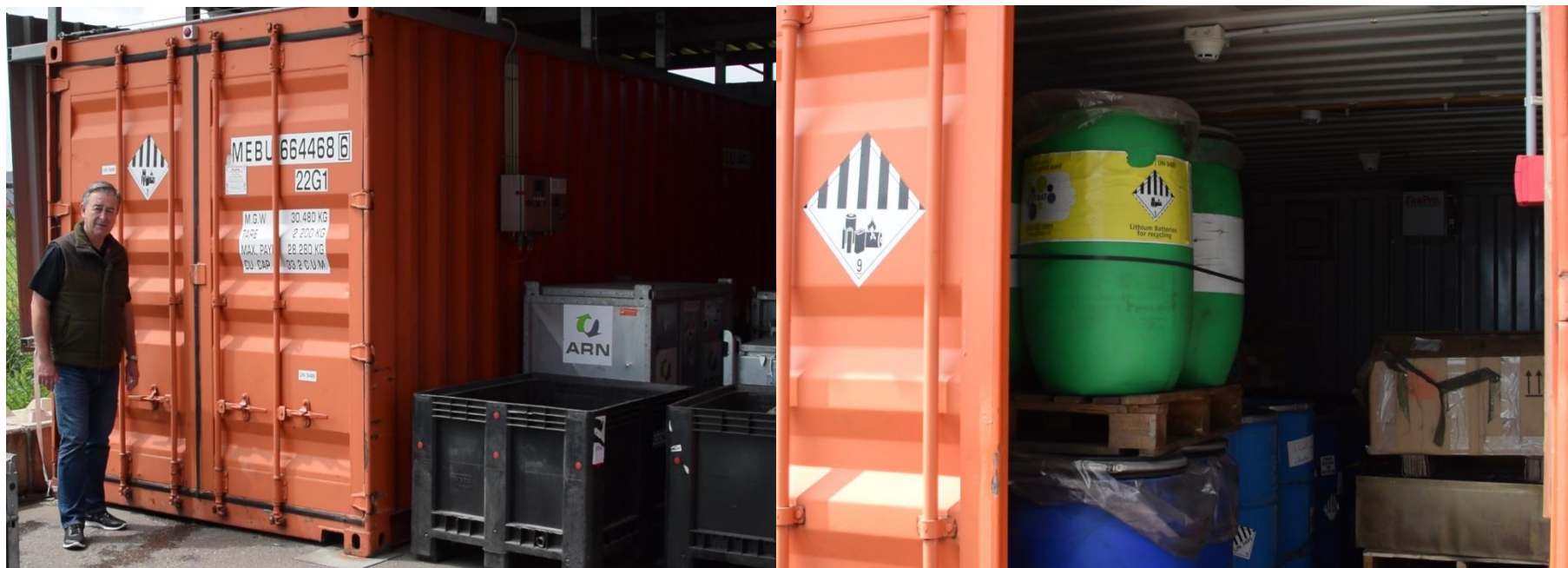

FirePro UK are active members of



[sales@fireprouk.com](mailto:sales@fireprouk.com)

[www.fireprouk.com](http://www.fireprouk.com)

Accredited for ISO 9001 by BSI





# Smart fire suppression



FirePro UK are active members of



[sales@fireprouk.com](mailto:sales@fireprouk.com)

[www.fireprouk.com](http://www.fireprouk.com)

Accredited for ISO 9001 by BSI



# Smart fire suppression



LARGE BUILDING

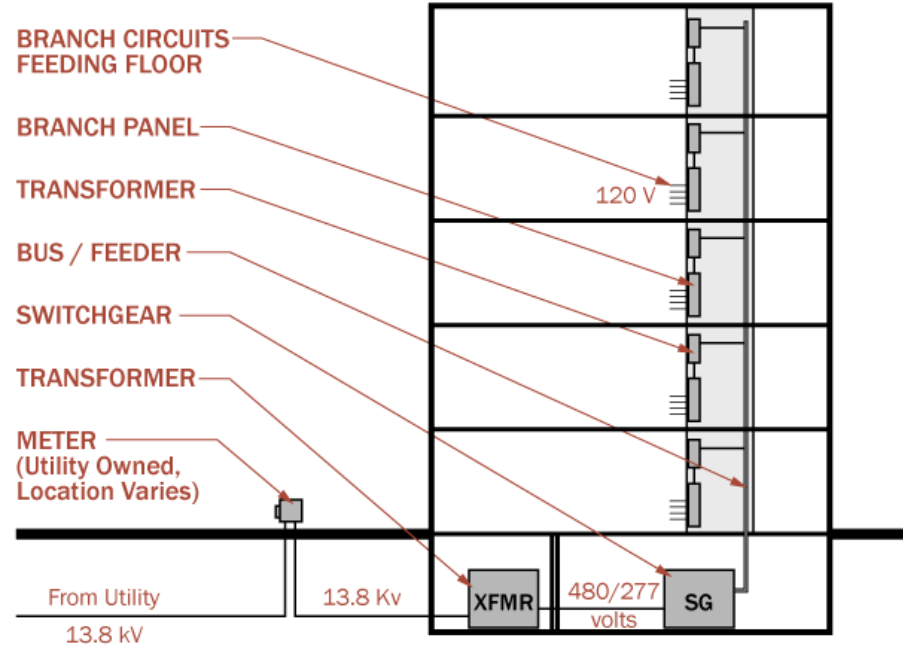

FirePro UK are active members of



[sales@fireprouk.com](mailto:sales@fireprouk.com)

[www.fireprouk.com](http://www.fireprouk.com)

Accredited for ISO 9001 by BSI



# The role of intelligent fire suppression

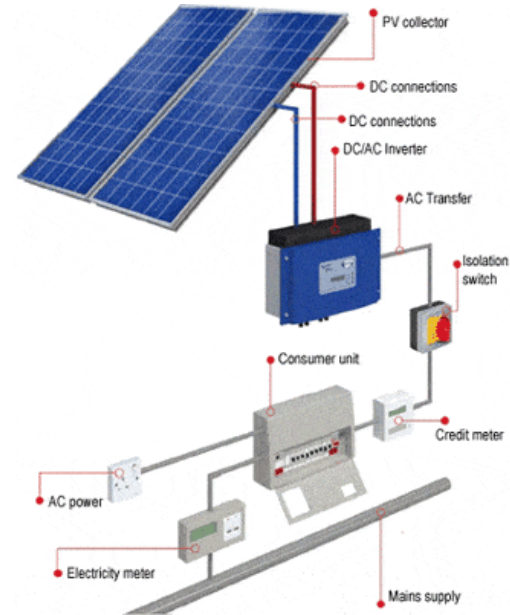

# The role of intelligent fire suppression

**FirePro.**  
[www.fireprouk.com](http://www.fireprouk.com)



# The role of intelligent fire suppression

**FirePro.**  
[www.fireprouk.com](http://www.fireprouk.com)



# The role of intelligent fire suppression



# Smart fire suppression



FirePro UK are active members of



[sales@fireprouk.com](mailto:sales@fireprouk.com)

[www.fireprouk.com](http://www.fireprouk.com)

Accredited for ISO 9001 by BSI



# Smart fire suppression



FirePro UK are active members of



[sales@fireprouk.com](mailto:sales@fireprouk.com)

[www.fireprouk.com](http://www.fireprouk.com)

Accredited for ISO 9001 by BSI





# Smart fire suppression



FirePro UK are active members of



[sales@fireprouk.com](mailto:sales@fireprouk.com)

[www.fireprouk.com](http://www.fireprouk.com)

Accredited for ISO 9001 by BSI



Thanks for your attention



CertLPCB ref. 1417a

  
Reinventing  
Fire Suppression

In Cabinet Active Fire Suppression for Fire Risks on NHS Premises

## CASE STUDY

Croydon Universities NHS Trust Hospitals

# In Cabinet Active Fire Suppression for Fire Risks on NHS Premises



This bank of 6 machines sterilise medical utensils by way of special cleaning process delivered at very high temperature and are critical for patient care services.



# In Cabinet Active Fire Suppression for Fire Risks on NHS Premises

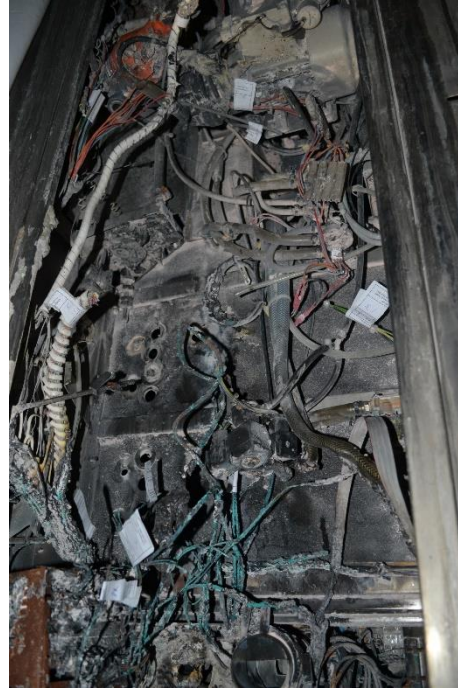

This is one of the machines following a serious internal fire which resulted in significant water and smoke damage as well as the loss of the machine and critical patient care services



# In Cabinet Active Fire Suppression for Fire Risks on NHS Premises



Attempts to fight the fire with portable extinguishers proved fruitless. Thankfully, Fire & Rescue services extinguished the fire, however it was much too late and the irreparable damage was done.



# In Cabinet Active Fire Suppression for Fire Risks on NHS Premises



The affected room and adjoining areas were cleaned and redecorated, and a replacement machine was ordered. The machines were on the 4<sup>th</sup> floor, so water damage was extensive.

Prior to the installation, the Trust consulted their fire systems specialist as to what measures might be employed to mitigate a serious re-occurrence.

The sources of internal ignition were identified as the motors and solenoids.



# In Cabinet Active Fire Suppression for Fire Risks on NHS Premises



The proposed fire detection and automatic suppression system met client requirements and incorporated fire engineering basics, such as battery backed / monitored power supply, fault monitored circuitry and remote signalling to various ancillary plant.

Localised fire detection and suppression is not new, however enclosure integrity may cause limitations when traditional mediums such as pressurised gas are used.

This was not an issue for FirePro, as it installed internally to afford maximum effective protection, at minimal cost.

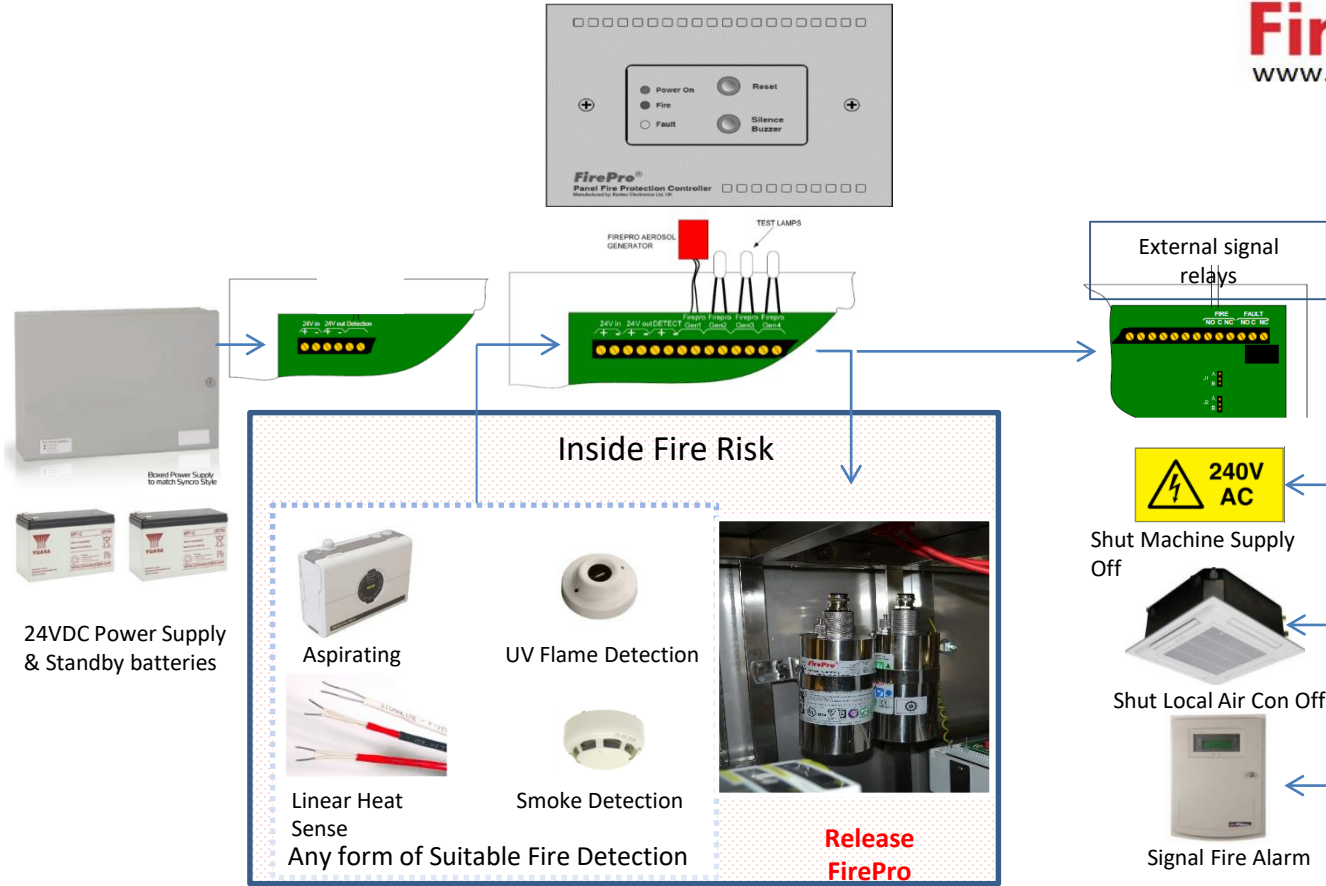

# In Cabinet Active Fire Suppression for Fire Risks on NHS Premises



Replacement machine installed

All now protected internally

Patient care service resumed



# In Cabinet Active Fire Suppression for Fire Risks on NHS Premises



Within 7 months of installation a second fire event occurred – however it was a very different story – Here is the hospital engineer opening up the machine access panels

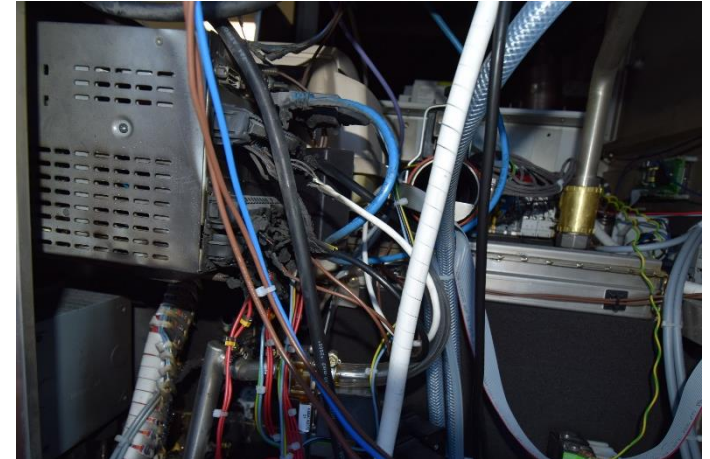

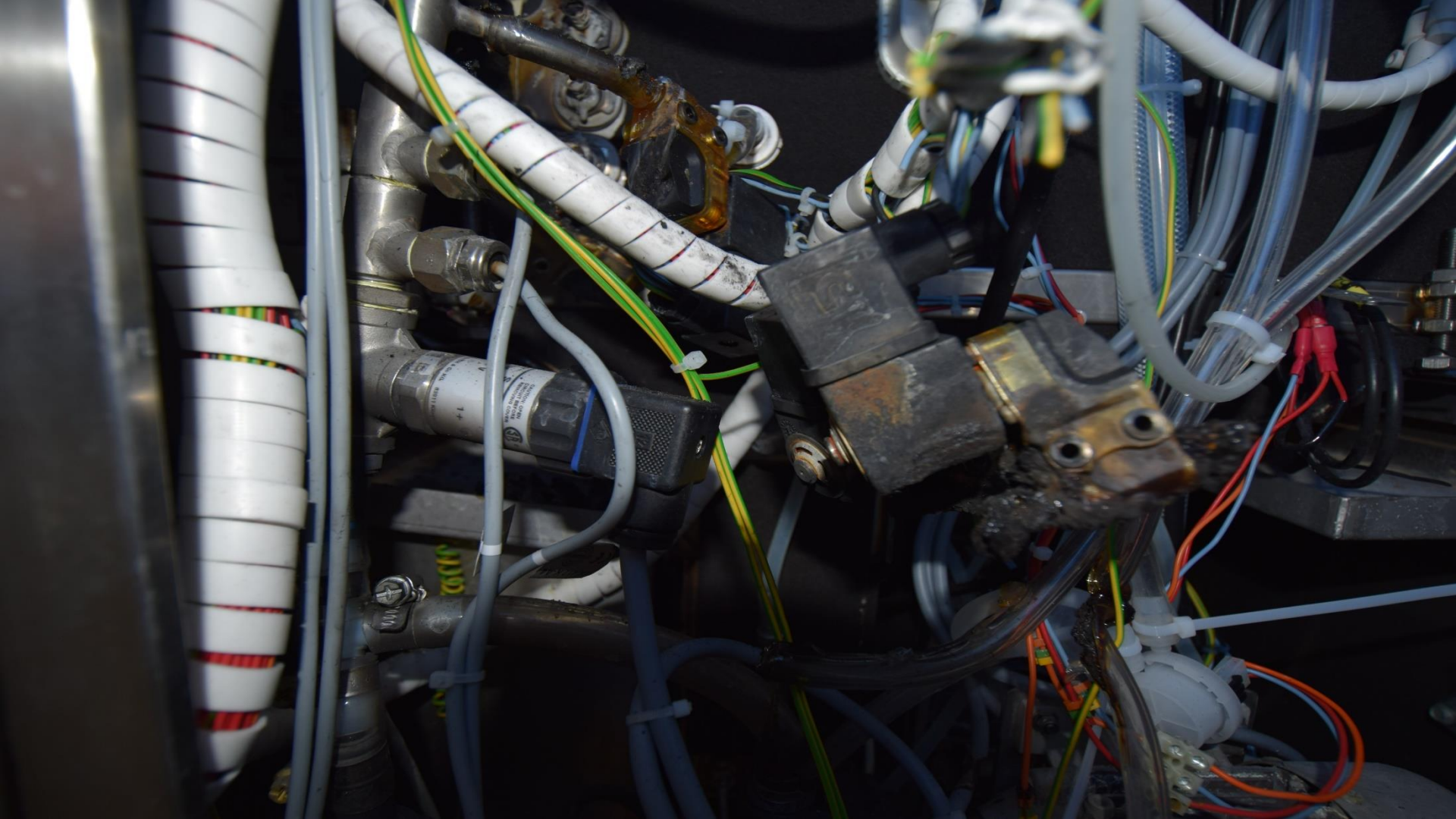

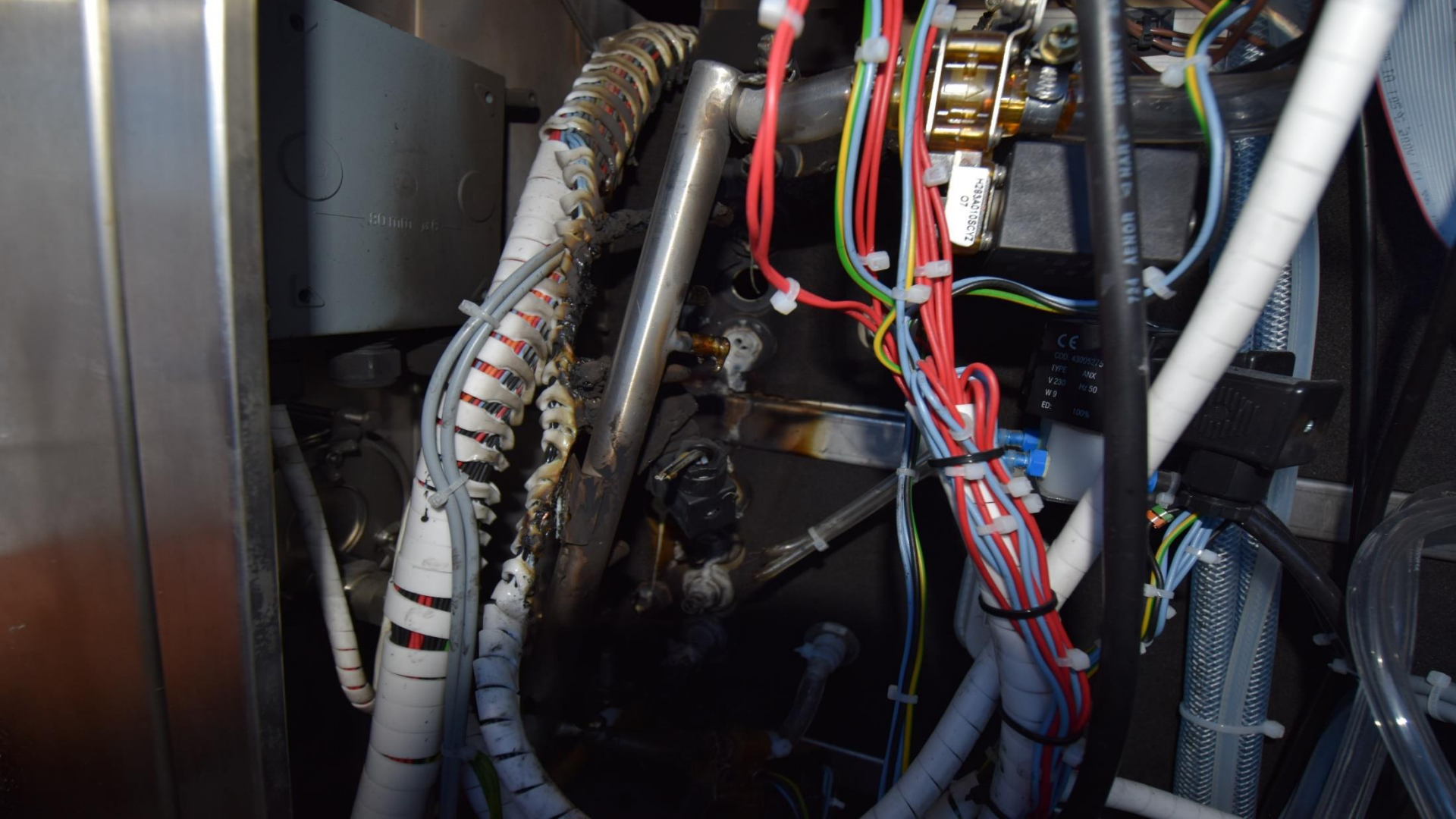

20mm

MSKAO105012  
07

CE  
COD: 4800570  
TYPE: MAX  
V 230 V 50  
W 9  
ED: 100%



CE 10  
CWA456R  
Fiber 2.0W 50/175 Pump 201  
175 C. Single-Mode Fiber  
a portion of ITT Industrial  
Laser Optics Division  
an Emerson Electric Company

OK



invensys  
Foxboro  
Power Supply  
Model: D16-230V  
115V AC Input  
230V AC Output  
10A Output  
100W Output  
CE  
RoHS  
UL  
CSA  
TUV



# In Cabinet Active Fire Suppression for Fire Risks on NHS Premises



Post fire –

- Machine overhauled & repaired
- System re-armed with FirePro
- Patient care resumed

In conclusion - installing local fire detection & suppression within the risk -

- Avoided a repeat major fire event
- Minimised patient care disruption
- Saved precious Fire & Rescue resources
- Significantly reduced clean up cost
- Enhanced estates team reputation
- Improved relations between NHS/LFB
- Firm evidence that the system works

Thanks for your  
attention

Any Questions